

Solenoid directional valves type **DKE**

direct operated, ISO 4401 size 10

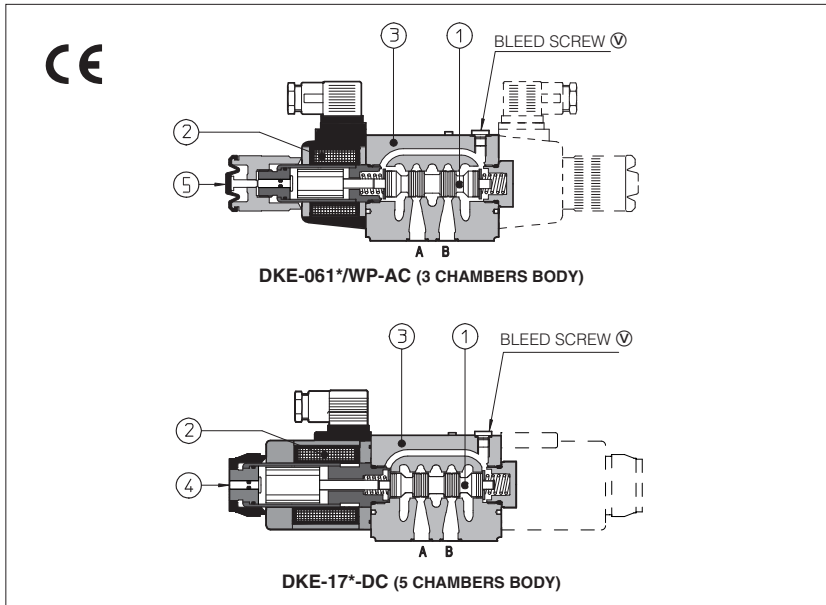

Spool type, direct operated valves with threaded solenoids certified according to the North American standard **cURus**

Single and double solenoid valves are available in two or three position configurations and with a wide range of interchangeable spools (1) with different schemes, three or four way connections, see section 2.

Solenoids (2) are made by:

- wet type screwed tube, different for AC and DC power supply, with integrated manual override pin (3)
- interchangeable coils, specific for AC or DC power supply, easily replaceable without tools - see section 5 for available voltages

Standard coils protection **IP65** (once correctly assembled with relevant electric connectors).

The coils are insulated according to class H for DC and F for AC versions.

The valve body (3) is 5 chamber type for all DC versions and for AC safety version /FI and FV

Standard AC version uses 3 chamber type body

The body is made by shell-moulding casting with wide internal passages ensuring low pressure drops

Options

- prolonged manual override protected with rubber cap (5) for easy hand operation
- control devices of the valve switching time
- spool position monitor devices for safety applications
- optional **IP67** AMP Junior Timer and Deutsch coil's connectors or lead wire for customized applications

Surface mounting ISO 4401 size 10
Max flow up to 150 l/min
Max pressure: 350 bar

1 MODEL CODE

DKE - 1 63 1/2 /A - X 24 DC ** /*

Directional control valves ISO 4401 size 10

Valve configuration, see section 2

- 61** = single solenoid, center plus external position, spring centered
 - 63** = single solenoid, 2 external positions, spring offset
 - 67** = single solenoid, center plus external position, spring offset
 - 70** = double solenoid, 2 external positions, without springs
 - 71** = double solenoid, 3 positions, spring centered
 - 75** = double solenoid, 2 external positions, with detent
- Other configurations are available on request.

Spool type, see section 2

Seals material:
 omit for NBR (mineral oil & water glycol)
PE = FPM











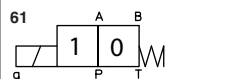

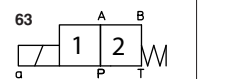
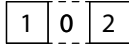
Series number

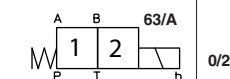
Voltage code, see section 5

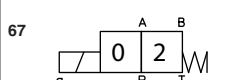
- 00-AC** = AC solenoids without coils
 - 00-DC** = DC solenoids without coils
 - X** = without connector
- See note 2 at section 4 for available connectors, to be ordered separately
 Coils with special connectors, see section 6
XJ = AMP junior Timer connector
XK = Deutsch connector
XS = Lead Wire connection

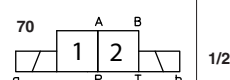
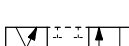
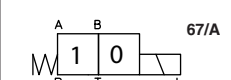
Options, see note 1 at section 4

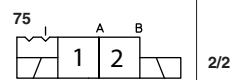
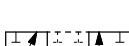
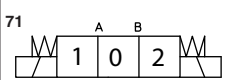
2 CONFIGURATIONS and SPOOLS (representation according to ISO 1219-1)

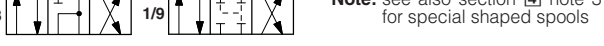
Configurations	Spools	Configurations	Spools
			
			
			
			
		<p>Note: see also section 4 note 3 for special shaped spools</p>	
			

3 MAIN CHARACTERISTICS OF DKE DIRECTIONAL VALVES

Assembly position / location	Any position for all valves except for type - 170* (without springs) that must be installed with horizontal axis if operated by impulses
Subplate surface finishing	Roughness index Ra 0,4 - flatness ratio 0,01/100 (ISO 1101)
MTTFd values according to EN ISO 13849	300 years, for further details see technical table P007
Ambient temperature	from -30°C to +70°C (standard seals) -20°C to +70°C (/PE seals)
Fluid	Hydraulic oil as per DIN 51524 ... 535; for other fluids see section 11
Recommended viscosity	15 ÷ 100 mm ² /s (ISO VG 15 ÷ 100) may allowed 2,8 ÷ 500 mm ² /s
Fluid contamination class	ISO 4406 class 21/19/16 NAS 1638 class 10, in line filters of 25 µm (β ₂₅ ≥ 75 recommended)
Fluid temperature	-30°C +60°C (standard seals) -20°C +80°C (/PE seals)
Flow direction	As shown in the symbols of table 2
Operating pressure	Ports P,A,B: 350 bar; Port T 210 bar for DC version (250 bar with option /Y); 160 bar for AC version
Rated flow	See diagrams Q/Δp at section 7
Maximum flow	150 l/min , see operating limits at section 8

3.1 Coils characteristics

Insulation class	H (180°C) for DC coils F (155°C) for AC coils Due to the occurring surface temperatures of the solenoid coils, the European standards EN ISO 13732-1 and EN ISO 4413 must be taken into account
Protection degree to DIN EN 60529	IP 65 (with connectors 666, 667, 669 correctly assembled)
Relative duty factor	100%
Supply voltage and frequency	See electric feature 5
Supply voltage tolerance	± 10%
Certification	cURus North American Standard

4 NOTES

1 Options

A = Solenoid mounted at side of port B (only for single solenoid valves). In standard versions, solenoid is mounted at side of port A.

WP = prolonged manual override protected by rubber cap - see section 12.

WPD/KE-DC = (only for DC supply) manual override with detent, to be ordered separately, see tab. K150

L, L1, L2, L3, LR, L7, L8 see section 11 = device for switching time control (only for DC solenoids).

L7 and L8 are available only for spool type 0/1, 1/1, 3/1, 4 and 5.

FI, FV = 5 chambers body for DC and AC versions with proximity switch for spool position monitoring; see tab. E110.

Y = external drain, only for DC version, to be selected if the pressure at T port is higher than the max allowed limits.

2 Type of electric connectors DIN 43650, to be ordered separately - see section 13.

666 = standard connector IP-65 for direct connection to electric supply source.

667 = as 666, but with built-in signal led.

669 = with built-in rectifier bridge for supplying DC coils by alternate current (AC 110V and 230V - I_{max} 1A).

3 Spools

- spools type **0** and **3** are also available as **0/1** and **3/1** with restricted oil passages in central position, from user ports to tank.

- spools type **1** is also available as **1/1**, properly shaped to reduce the water-hammer shocks during the switching.

- spool type **1/9** has closed center in rest position but it avoids the pressurization of A and B ports due to the internal leakages.

- other types of spools can be supplied on request.

5 ELECTRIC FEATURES

External supply nominal voltage ± 10%	Voltage code	Type of connector	Power consumption (2)	Code of spare coil
12 DC	12 DC	666 or 667	36 W	CAE-12DC
14 DC	14 DC			CAE-14DC
24 DC	24 DC			CAE-24DC
28 DC	28 DC			CAE-28DC
110 DC	110 DC			CAE-110DC
220 DC	220 DC			CAE-220DC
110/50/60 AC	110/50/60 AC	669	85 VA (3)	CAE-110/50/60AC (1)
230/50/60 AC	230/50/60 AC			CAE-230/50/60AC (1)
115/60 AC	115/60 AC			CAE-115/60AC
230/60 AC	230/60 AC			CAE-230/60AC
110/50/60 AC	110 DC			CAE-110DC
230/50/60 AC	220 DC		36 W	CAE-220DC

(1) In case of 60 Hz voltage frequency the performances are reduced by 10÷15% and the power consumption is 80 VA

(2) Average values based on tests performed at nominal hydraulic condition and ambient/coil temperature of 20°C.

(3) When solenoid is energized, the inrush current is approx 3 times the holding current. Inrush current values correspond to a power consumption of about 280 VA

6 COILS TYPE CAE WITH SPECIAL CONNECTORS (only for 12DC, 14DC, 24DC and 28DC)

Options -XJ

Coil type CAEJ

AMP Junior Timer connector

Protection degree IP67

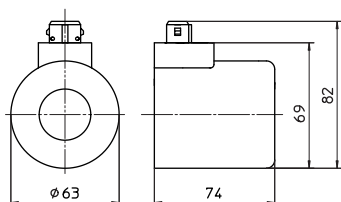

Options -XK

Coil type CAEK

Deutsch connector, DT-04-2P male

Protection degree IP67

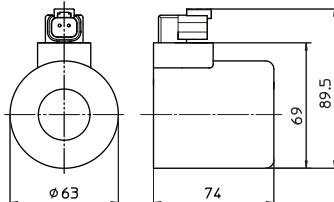

Options -XS

Coil type CAES

Lead Wire connection

Cable length = 180 mm

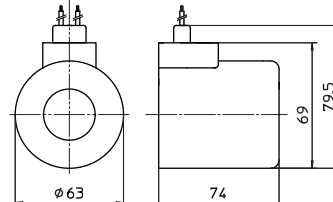

7 Q/ΔP DIAGRAMS based on mineral oil ISO VG 46 at 50°C

Flow direction Spool type	P→A		P→B		A→T		B→T		P→T		B→A	
	A	A	B	B	C	C	D	D	F	F	G	G
0, 0/1, 0/2, 2/2	A	A	B	B								
1, 1/1, 1/9, 6, 8	A	A	D	C								
3, 3/1, 7	A	A	C	D								
4	B	B	B	B	F							
5, 58	A	B	C	C	G							
1/2	B	C	C	B								
19, 91	F	F	G	G							H	
39, 93	F	F	G	G							H	

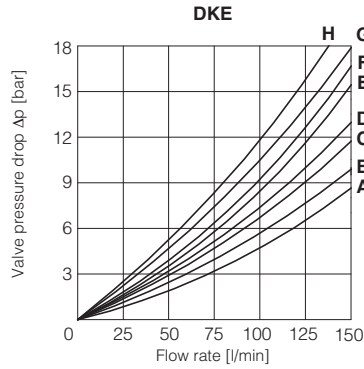

8 OPERATING LIMITS based on mineral oil ISO VG 46 at 50°C

The diagrams have been obtained with warm solenoids and power supply at lowest value ($V_{nom} - 10\%$). The curves refer to application with symmetrical flow through the valve (i.e. P→A and B→T). In case of asymmetric flow and if the valves have the devices for controlling the switching times the operating limits must be reduced.

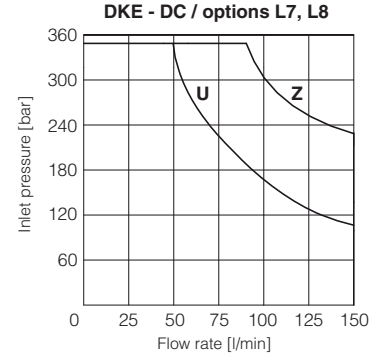
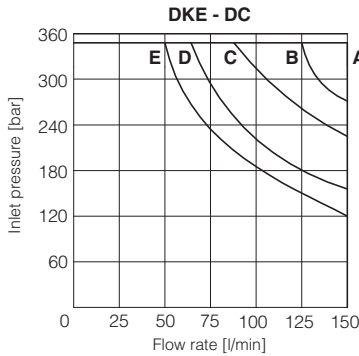
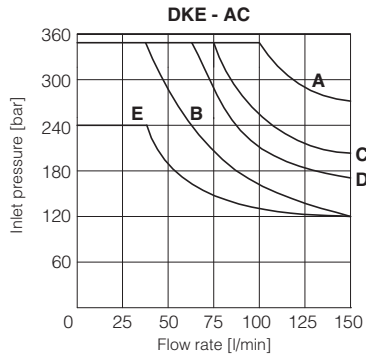

Curve	Spool type	
	AC	DC
A	0/1	0, 0/1, 1, 1/1, 3, 3/1, 1/2, 0/2, 8
B	4, 5, 19, 91	6, 7
C	0, 1/1, 3, 3/1	19, 91
D	1, 1/2, 0/2	4, 5
E	6, 7, 8, 2/2	2/2
U	-	4, 5
Z	-	0/1, 1/1, 3/1

9 SWITCHING TIMES (average values in msec)

Valve	Switch-on AC	Switch-on DC	Switch-off AC	Switch-off DC
DKE + 666 / 667	40	60	25	35
DKE + 669	60	—	90	—
DKE-*/L*	—	75÷150	—	45÷150
DKE-*/L7 - DKE-*/L8	—	100÷150	—	100÷150

Test conditions:

- 50 l/min; 150 bar
- nominal supply voltage
- 2 bar of back pressure on port T
- mineral oil ISO VG 46 at 50°C

The elasticity of the hydraulic circuit and the variations of the hydraulic characteristics and temperature affect the response time.

10 SWITCHING FREQUENCY

Valve	AC (cycles/h)	DC (cycles/h)
DKE + 666 / 667	7200	15000

11 DEVICES FOR SWITCHING TIME CONTROL

These devices are only available for DC valve version (5 chambers body) and can control the switching time and therefore reduce the coil hammering in the hydraulic circuit. The different types are available shown in the figure.

- **L**: controls and regulates the switching time in both moving directions of the spool: regulation is carried out by screwing/unscrewing the element itself (regulating choke);
- **L1/L2/L3**: controls the switching time in both moving directions of the spool by means of fixed calibrated restrictor (gauged flow). The restrictor is positioned in the valve's body $\varnothing L1 = 1,25 \text{ mm}$; $\varnothing L2 = 1 \text{ mm}$; $\varnothing L3 = 0,75 \text{ mm}$;
- **LR**: controls and regulates the switching time in the B→A direction of the spool movement. The device does not control the switching time (standard time) in the opposite direction A→B of the spool movement.
- **L7/L8**: controls the switching time in both moving directions of the spool by means of fixed calibrated restrictor (gauged flow). The restrictor is installed in the solenoid's anchor.

For a correct operation of the switching time control, the passage in which the control device is installed must be completely filled with oil.

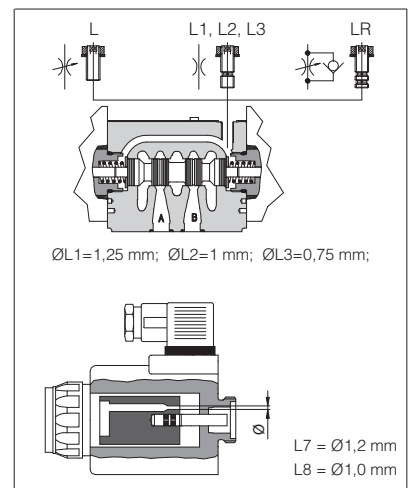

12 INSTALLATION DIMENSIONS [mm]

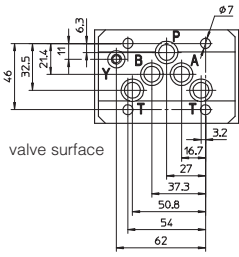

ISO 4401: 2005
Mounting surface according to 4401-05-05-0-05
(without X port, Y port optional)
 Fastening bolts:
 4 socket head screws M6x40 class 12.9
 Tightening torque = 15 Nm
 Seals: 5 OR 2050 and 1 OR 108
 Ports P,A,B,T: Ø = 11.5 mm (max)
 Ports Y: Ø = 5 mm

P = PRESSURE PORT
A, B = USE PORT
T = TANK PORT
Y = DRAIN PORT (only for option /Y)
 For the max pressures on ports, see section 3

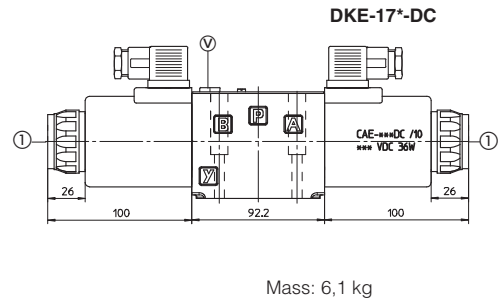
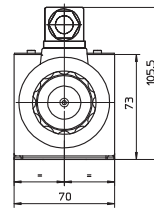
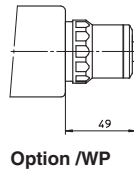
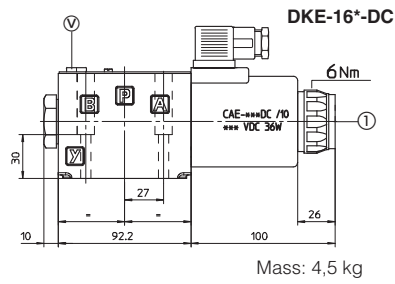
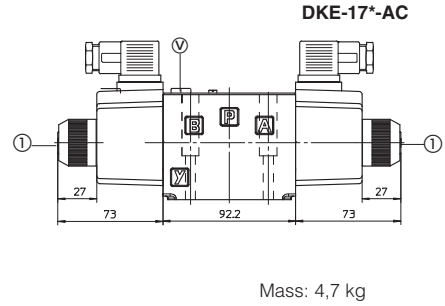
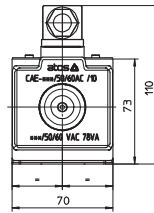
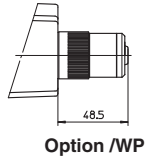
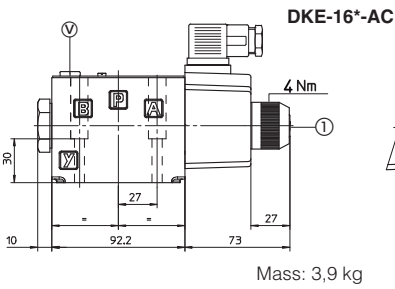

① Standard manual override PIN. The manual override operation can be possible only if the pressure at T ports is lower than 50 bar

13 ELECTRIC CONNECTORS ACCORDING TO DIN 43650 The connectors must be ordered separately

<p>666, 667 (for AC or DC supply)</p>	CONNECTOR WIRING	
	<p>666, 667 1= Positive ⊕ 2= Negative ⊖ ⊕ = Coil ground</p>	
	SUPPLY VOLTAGES	
666 All voltages	667 24 AC or DC 110 AC or DC 220 AC or DC	

14 MOUNTING SUBPLATES

Model	Ports location	GAS Ports A-B-P-T (X-Y)	Ø Counterbore [mm] A-B-P-T (X-Y)	Mass [kg]
BA-308	(/Y) Ports A, B, P, T (X, Y) underneath	1/2" (1/4")	30 (21,5)	2,5
BA-428	(/Y) Ports A, B, P, T (X, Y) underneath	3/4" (1/4")	36,5 (21,5)	5,5
BA-434	(/Y) Ports P, T, (X, Y) underneath; ports A, B on lateral side	3/4" (1/4")	36,5 (21,5)	8,5

The subplates are supplied with 4 fastening bolts M6x40. Also available are multi-station subplates and modular subplates. For further details see table K280.