

## General Description

Series DY05 are two stage, 4-way, flapper and nozzle style servo valves. The DY05 has a wide range of flow ratings within a lower cost spool and body design. The unique rigid pin feedback design avoids ball glitch problems, which can occur in other types of servo valves. These valves are rated for 210 Bar (3000 PSI) standard, or can be built for 350 Bar (5000 PSI) service. The pressure ratings are the same for both the tool steel construction or the optional stainless steel spool and body.

## Features

- Lapped spool and body.
- No ball glitch.
- Tool steel, or stainless steel, spool and body.
- Versatile 21.59 mm (0.850 in.) port circle, can mount to standard 19.81 mm (0.780 in.) and 23.62 mm (0.930 in.) port circle patterns.
- Survives high tank port pressures.

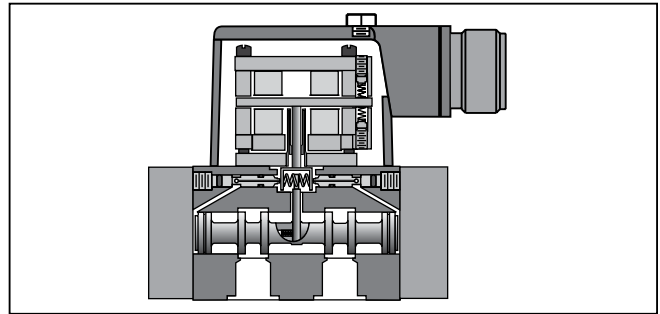
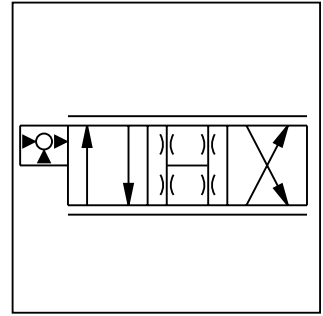
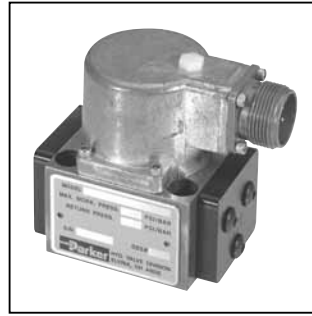

**C**

## Specifications

<b>Flow Rating</b> @ 70 Bar (1000 PSID)	0.95, 1.9, 3.8, 9.5 and 19 LPM (0.25, 0.5, 1.0, 2.5 & 5 GPM)	<b>Null Shift</b> with temperature with pressure	≤ 2% per 55°C (100°F) ≤ 2% per 70 Bar (1000 PSI)
<b>Supply Pressure</b>	10 – 210 Bar (145 – 3000 PSI) opt. 350 Bar (5000 PSI)	<b>Pressure Gain</b> % change in pressure per 1% change in input command	30% minimum, 70% maximum
<b>Leakage Flow</b> @ 70 Bar (1000 PSID)	0.42 – 0.95 LPM (0.11 – 0.25 GPM)	<b>Step Response</b>	10 – 90%, < 11 ms
<b>Tank Port Pressure</b>	210 Bar (3000 PSI) Max. < 10 Bar (145 PSI) for best performance	<b>Fluid</b>	Mineral Oil, 60 – 225 SSU 1000 SSU maximum
<b>Input Command</b>	±50 mA std.	<b>Operating Temperature</b>	-1°C to +82°C (+30°F to +180°F)
<b>Frequency Response</b> @ 90° phase shift	> 100 Hz (See Performance Curves)	<b>Protection Class</b>	NEMA 4, IP65
<b>Non-Linearity</b>	≤ 10%	<b>Filtration</b>	ISO 4406 15/12 or better
<b>Threshold</b>	≤ 0.5%		

**DY05**

Series

Material  
 Options

Coils

Wiring

Seal

Operating  
 Pressure

Flows

Special  
 Options

Factory Code for Special Options

Code	Description
A	Steel (standard)
B	Stainless Steel
Z*	Special (specify)

\* Material selection does not affect operating pressure.

Code	Description
Omit	Standard
D	(Specify) See list below

Code	Description
0.25	0.95 LPM (0.25 GPM)
0.5	1.9 LPM (0.5 GPM)
1	3.8 LPM (1 GPM)
2.5	9.5 LPM (2.5 GPM)
5	19 LPM (5 GPM)

Code	Description	Parallel	Series
D	200 ohm (Std.)	50 mA	25 mA
F	80 ohm	80 mA	40 mA
G	22 ohm	200 mA	100 mA
K	40 ohm	150 mA	75 mA
L	360 ohm	30 mA	15 mA
M	475 ohm	40 mA	20 mA
R	750 ohm	30 mA	15 mA
T	1000 ohm	10 mA	5 mA
V	1200 ohm	40 mA	20 mA
Z	Special (specify)		

Code	Description
A	210 Bar (3000 PSI)
B	350 Bar (5000 PSI)
Z	Special (specify)

Operating pressure is independent of material selection.

**Weight:** 1.0 kg (2.1 lbs.)

Code	Description
N	Nitrile (standard)
V	Fluorocarbon
E*	EPR
Z*	Special (specify)

\* Consult factory for delivery

Code	Connector over:	Flow P to C2 with:
C	Port C1	(+) Signal to A, C
D	Port C1	(+) Signal to B, D
Z	Special (specify)	

**Special Options:**

Consult factory for price, delivery and availability of special options.

- Special coil
- Special wiring
- Special seals
- Special flow rate
- Dual flow rate
- Dual gain
- Zener barriers
- High frequency torque motor (Models 5, 10, 12 & 15 only)

**Accessories**

**Cable with Mating Connector:** EHC154S

**Mating Connector:** MS3106E-14S-2S

**Bolt Kit:** Included with Valve

**Flushing Valve:** 11-0500

**Subplate:** 55-0100-8S SAE-8 Side ports

**Null Adjust Tool:** 6522A13

**Electronic Drivers:** 23-7030, BD90\*, BD101\*

When used in conjunction with Series BD90 and BD101 servo amplifiers or a motion controller, Series BD valves will provide accurate control of rotary and linear actuators.

\* For output currents >15 mA

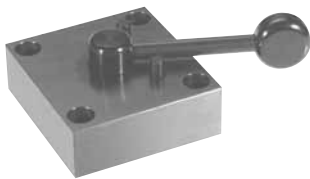

Flushing valve is rated for 3000 psi operation.

**Wiring Option C  
 (Standard)**

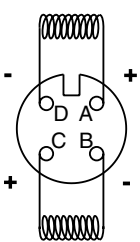

Dyval and Pegasus standard.

**Wiring Option D**

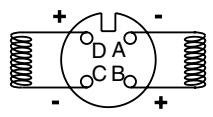

Moog, Atchley and Vickers standard.

In both cases, polarity shown connects P to C2 port.

**Performance Curves**

**Frequency Response**

**DY05 Flow vs. Pressure Drop**  
 at 100% command  
 Flow Path: P → C1 → C2 → T

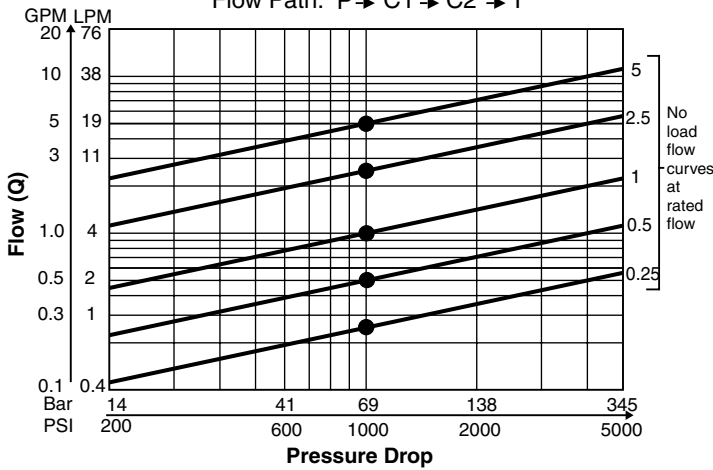

**DY05 at 3000 PSI**  
 All curves ± 40% Amplitude

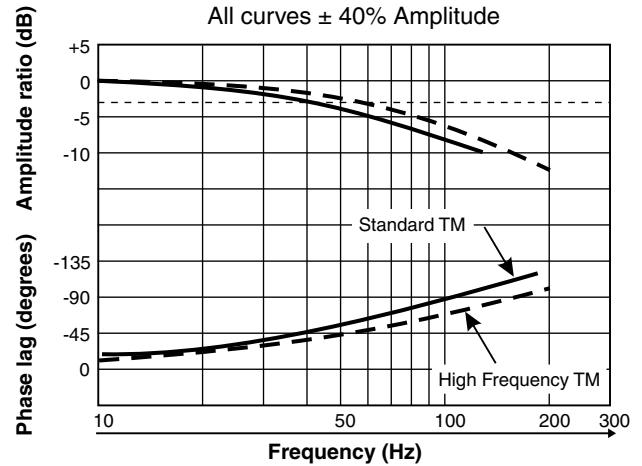

**Installation Wiring Options**

This servovalve has two coils. This illustration shows the internal wiring configurations for options C and D. When connecting the valve to a drive amplifier, the user's external wiring may put the coils either in parallel or in series as needed. Refer to the illustrations below and to the mounting pattern for this valve to insure proper control phasing.

**Option C**

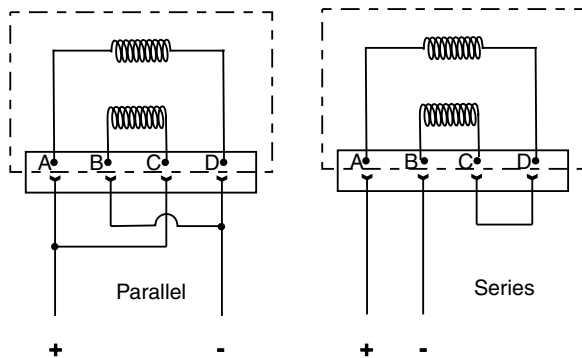

**Option D**

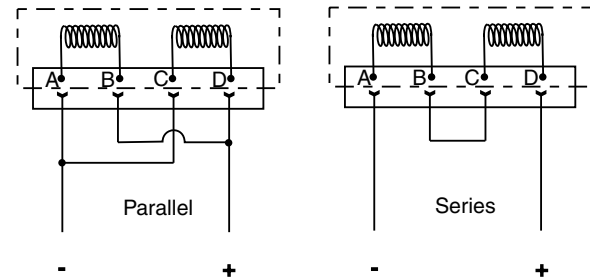

Polarity shown connects flow from P to C2 port.

Inch equivalents for millimeter dimensions are shown in (\*\*)

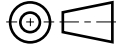
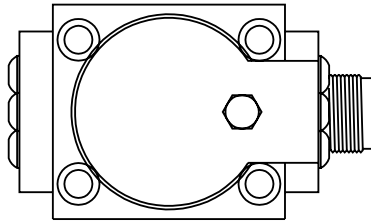

**C**

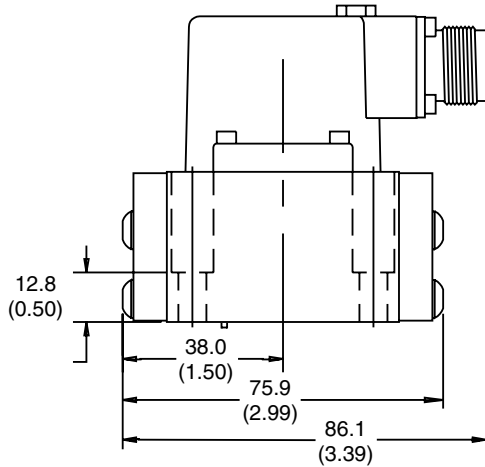

Connector over port C1

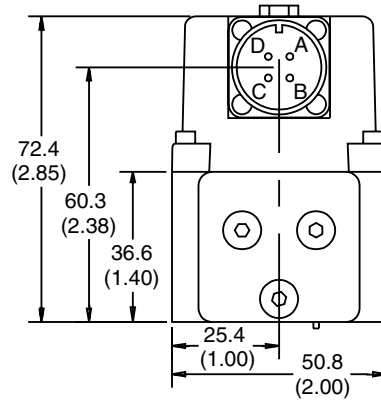

**Mounting Interface**

Inch equivalents for millimeter dimensions are shown in (\*\*)

