

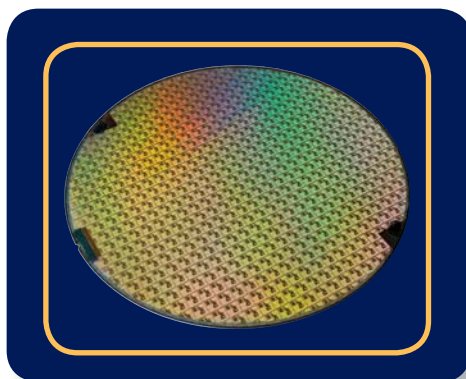

ETHERNET Powerlink

Real-Time Industrial Ethernet
Solutions for Automation

ETHERNET Powerlink MotionBus System



A global leader in motion control, Parker understands the challenges facing OEMs in such high-tech industries as medical device, semiconductor and flat panel display manufacturing. To help meet these challenges, Parker has built a team of highly experienced motion system designers who use a systematic project management process to deliver the most advanced linear motion technology available. And it's all backed by the global infrastructure high-tech OEMs look for in motion partners.

For medical device manufacturers, Parker's integrated automation solutions are specifically designed to reduce both your time to market and engineering costs while helping you comply with today's stringent government regulations.



With expertise in vacuum preparation, cleanroom preparation facilities, and extensive large-format system experience, we design and build motion components and systems that enable your technology and increase your throughput through precise and coordinated motion.



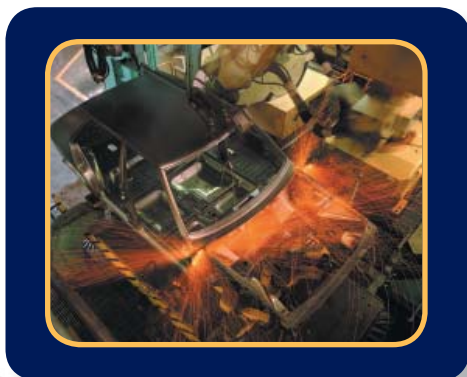

Industrial automation solutions from Parker Automation combine speed, accuracy and high-load capability to give machine builders and OEMs a competitive edge.

Parker is the only supplier that can provide complete technical and engineered solutions to OEMs for any packaging requirement. Parker's innovative engineering, breadth of line, worldwide distribution, and outstanding customer service set the standard for the industrial motion market.

- Application Analysis
- Engineering Assistance
- Systems Design
- Assemblies, Kits and Sub-Systems
- 2-Year Warranty
- ISO Certified
- Global Support and Services



ETHERNET Powerlink MotionBus System

Industrial Ethernet

Ethernet networks have enjoyed popularity in industrial plants for many years. Typically applied at higher levels, Ethernet has been the chosen network for such non time-critical communications as IT networks and gathering data from the factory floor. For automation applications, which require very precise timing, more dedicated network topologies utilizing lower bandwidth fieldbus networks have been used.

Ethernet Benefits

- **Widely deployed and understood**
- **Network visibility**
- **All Digital system reduces EMI susceptibility**
- **Commonality of Ethernet hardware components reduces cost**

Digital Motionbus

A motionbus is a digital communications network that replaces the traditional analog +/- 10V command signal between a motion controller and a servo drive. In today's world of digital drives and controls, it no longer makes sense to pass an analog signal from controller to drive.

In addition to the advantages of digital communications, a motionbus is designed with a high bandwidth to pass both control and motor feedback information. This eliminates the need for a feedback cable from the drive to the controller, thereby reducing system wiring. Additional system benefits are then realized with faster installations, lower maintenance costs and higher system reliability.

Motionbus Benefits

- **All Digital system reduces EMI issues**
- **Simplified cabling**
- **Reduced installation time**
- **Single communications access point to system**



ETHERNET Powerlink - The Winning Combination

ETHERNET Powerlink (EPL) is a high-speed, digital motionbus solution connecting a motion controller to multiple drives and I/O points using standard Ethernet networking hardware. This centralized, real-time communication system for automation and motion control makes Ethernet deterministic for real-time industrial applications.

ETHERNET Powerlink is a powerful motionbus solution that combines the benefits of fieldbus network wiring, Ethernet speeds and visibility, consumer volume hardware costs and open platforms.

ETHERNET Powerlink Benefits

- Standard cabling and hubs support any topology
- Both the front office and the manufacturing floor can use the same Ethernet network
- IT techs already trained on installation
- Consumer volumes drive hardware costs down
- Open standard for greater flexibility
- All Digital system reduces EMI issues

ETHERNET Powerlink is an industrial Ethernet solution for automation featuring real-time performance, microsecond precision and standard Ethernet hardware. Determinism, or guaranteed timing of information, is achieved with standard Ethernet hardware by using network time-slot management. Each ETHERNET Powerlink-controlled node (CN) has a dedicated time slot with which to send and receive information to and from the managed node (MN).

ETHERNET Powerlink is an open standard maintained by the ETHERNET Powerlink Standardization Group. Multiple vendors, OEMs and users drive the standard so that it addresses the needs of the industry. Being an open standard, ETHERNET Powerlink is free from typical patent and IP ownership that can negatively affect the availability and attractiveness of a single-vendor solution.

ETHERNET 
POWERLINK
Standardization Group

ETHERNET Powerlink MotionBus System



**ACR9040 multi-axis
EPL controller**

EPL Controller Responsibilities (EPL Managing Node or MN)

- Stores and runs the motion program
- Supervises and controls local drive I/O and system expansion I/O
- Generates motion trajectories for all axes
- Sends position set points to drives
- Synchronizes positions of multiple axes for tightly coordinated motion

Commanded position/velocity,
digital outputs, drive enable,
drive reset

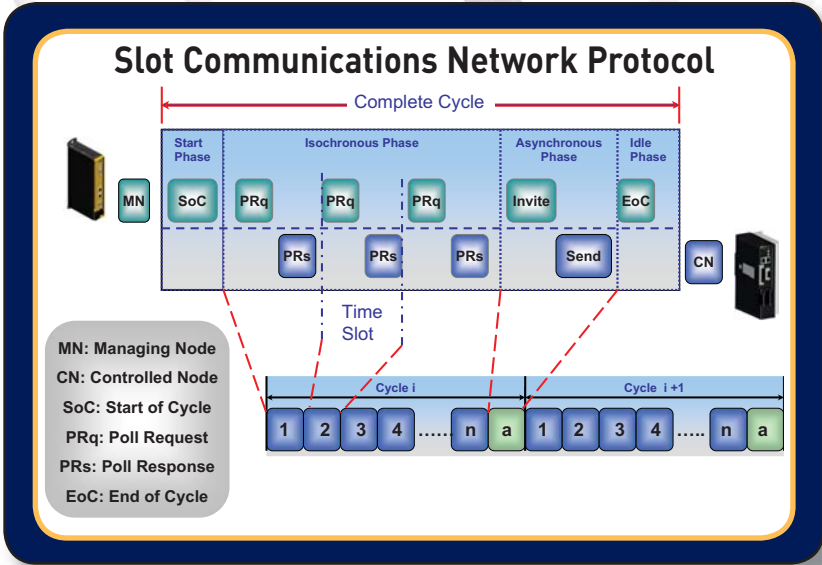



ETHERNET Powerlink Communications

- Replace the traditional +/- 10V analog control and feedback cables with an all digital Ethernet network
- Real Time, deterministic data to and from nodes is guaranteed each cycle with the Slot Communications Network Protocol, illustrated in the diagram below
- Proven, robust CANopen profiles are sent over proven, robust Ethernet hardware
- Standard TCP/IP communications does not interrupt determinism, as it takes place during the asynchronous slot at the end of the cycle
- Excellent performance with timing jitter <1us

Aries EPL servo drive



Actual position/velocity, inputs, following error, torque, drive fault, extended axis status

EPL Drive Responsibilities (EPL Controlled Node or CN)

- Closing servo loops including torque, velocity and position loops
- Local I/O (7 in, 4 out)
- High speed inputs for registration
- Encoder feedback from motor

ETHERNET Powerlink MotionBus System

System Design Solutions

When the ACR EPL controllers are combined with the high-speed ETHERNET Powerlink motionbus, the design possibilities are virtually limitless. Whether the application requires the flexibility of distributed control, or the tight synchronization of high performance centralized control, the Parker EPL system delivers.

Machine Design Flexibility

Drives can be linked in a simple, cost effective daisy chain arrangement, in a tree structure or a combination of both, utilizing the built in hubs in the drives and controller. Since EPL employs standard Ethernet hardware, devices can be separated by up to 100 meters, or external hubs can be employed to further expand the configuration possibilities.

The capability to specify up to 8 independent coordinate systems, program 16 separate concurrently running tasks and distribute drives throughout the machine Parker's EPL system a truly modular design choice.

Connectivity

The ACR EPL controllers include a separate Ethernet port for TCP/IP and EtherNet/IP traffic. The ACR controller acts as a gateway between the real-time EPL domain and other communications allowing the EPL network to remain focused on time critical motion and I/O functions. The controller can service multiple communications channels at once giving users many options for PC and PLC connectivity in development and normal operation.





Parker EPL Solutions

- **Modular**
- **Scaleable for future development or machine platforms**
- **Simplified Cabling**
- **Single communication access point**
- **Centralized or decentralized architectures**

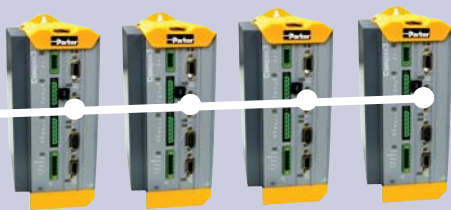
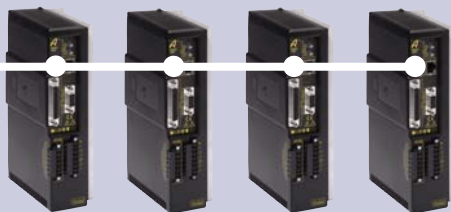

Faster Set-up, Enhanced Performance, Less Downtime

Parker's EPL system offers many advantages before, during and after machine commissioning. Offering a choice of communications options including Ethernet, USB or serial, the ACR EPL becomes a virtual hub allowing access to all the drives and I/O in the system. Drive configuration, set-up and even firmware upgrades can all be accomplished using the ACR-View Software Development Kit. Auto-inertia detection significantly simplifies the tuning process.

Ease of Troubleshooting

As part of the standard EPL cycle, a complete set of drive status parameters is transmitted back to the controller. HMI's, application programs and error handling routines all have immediate access to this status information, greatly enhancing the EPL systems' ability to intelligently handle and troubleshoot drive events.

Modular Maintenance

Since drives can be removed or added to the system without dropping the entire network, machine downtime can be reduced by enabling maintenance on independent machine modules while the rest of the machine is operating.

ACR EPL Motion Controllers



ACR9040 EPL

ETHERNET Powerlink expands the ACR EPL family by adding a real-time motion controller over standard Ethernet hardware. The high speed digital communications network enhances machine performance and configuration possibilities while reducing set-up time and installation complexity.

Features

- Control of 16 ETHERNET Powerlink drives
- 10/100 Base-T Ethernet
- USB 2.0
- EtherNet/IP compatibility
- CANopen expansion I/O
- CE (EMC & LVD), UL and cUL Recognized
- Multitasking of up to 24 simultaneous programs
- Interpolation of 8 axes in any combination
- ACR9030 has up to 8 axes of analog servo or stepper control

Fast, Efficient, Connected

The ACR EPL family is Parker's premier standalone motion controller family, capable of controlling up to 16 axes of motion. Connectivity and communication features give the ACR EPL flexibility for use in a wide variety of machine architectures. The ACR EPL excels as a standalone machine and motion controller, interfacing with a PC or working alongside a PLC. A powerful DSP makes the ACR EPL an outstanding multi-tasking servo controller. The ACR EPL includes easy-to-use project-development tools that enable fast, efficient application creation and maintenance. The ACR EPL is the solution for standalone applications requiring industry-leading performance in an affordable and easy-to-use package.

Controller Available in Two Different Form Factors

ACR9040 - EPL Controller Only

- **9040** is a compact, cost effective, EPL only controller. Only requiring 24VDC input power, the 9040 includes Ethernet, USB and an integrated 2-port hub for ETHERNET Powerlink connections. I/O can be added using CANopen or by utilizing the inputs and outputs on the EPL drives.

ACR9030 - EPL controller with additional stepper and servo outputs

- **9030** offers the flexibility of combining traditional servo and stepper outputs with EPL drives. The 9030 can be configured with 2, 4, 6, or 8 servo/stepper axes for a total of 16 axes of control. On-board I/O and auxiliary encoder inputs are included, and additional I/O can be added using CANopen or by utilizing the inputs and outputs on the EPL drives. This unit requires 120/240VAC input.



Aries EPL Servo Drive

Compact, Versatile, Performance

Features

- ETHERNET Powerlink enabled servo drive
- Integrated 2 port Ethernet hub
- Rotary or linear servo motor control
- 3, 4.5 and 6.3 A RMS continuous current
- 120/240 VAC power input
- Multiple feedback options –
 - Smart encoder, quadrature encoder, Heidenhain EnDat absolute encoder
- Auto-Tuning
- CE (EMC & LVD), UL recognized



Aries EPL

The Aries EPL servo drives combine Parker's high performance digital servo control technology with the real time performance benefits of ETHERNET Powerlink motionbus technology.

The Aries EPL servo drives deliver all the performance benefits that digital drive technology has to offer including fast update rates and ease of installation. The Aries EPL can run rotary or linear servomotors with a wide range of feedback devices, making it the ideal drive choice to solve a variety of machine applications.

Compax3 EPL Servo Drive

Rugged, Industrial, Powerful

Features

- ETHERNET Powerlink enabled servo drive
- Integrated 2 port Ethernet hub
- Rotary or linear servo motor control
- From 2.5 to 155 A RMS continuous current
- Built in regeneration and line filtering
- 120/240/480 VAC single and three phase power input
- Quadrature encoder, absolute encoder and resolver feedback
- CE (EMC & LVD), UL and cUL recognized

The Compax3 servo drives combine a high performance, digital design with industrial ruggedness and expansive power capabilities.



Compax3 EPL

The Compax3 servo drives are designed for industrial applications with heavy duty features such as built in regeneration capabilities and AC input line filtering. The wide variety of power levels, up to 155 A RMS, ensures that no application is too large for the Compax3 servo drive.

ETHERNET Powerlink MotionBus System

ACR EPL...Connect



The EtherNet/IP™ network is designed to use standard Ethernet and TCP/IP equipment for the industrial environment. The application layer protocol is an open standard—CIP™ (Control and Information Protocol). CIP is the same upper-layer protocol used by DeviceNet™ and ControlNet™ networks, allowing interoperability between various industrial devices.

EtherNet/IP Included

The ACR EPL can operate as a server/slave device within an EtherNet/IP network. This protocol is enabled in all ACR EPL controllers with Ethernet. No special order code or software is required. The EtherNet/IP protocol can run alongside standard TCP/IP, bringing together plant floor automation and office networks.

ACR EPL with Interact and InteractX™

Integrating the ACR EPL with Parker's CTC HMI is accomplished over EtherNet/IP.

- Drivers are available to enable communications to PA, EPX, PS, PX, HPC and HPX series
- Supports point-to-point or networked connections
- Parameters and BIT address referencing
- InteractX Windows HMI with unlimited tags
- Breakthrough graphic technology
- Panel tool library for easy screen development (no scripting)



Advanced Motion with PLC Automation

EtherNet/IP capability gives ACR EPL users a popular connectivity option to PLCs and other master devices supporting the protocol.

Applications can be developed in AcroBASIC and reside in the 9000. The controller is added to the EtherNet/IP network as a slave I/O device, allowing the master PLC to interrogate or set any controller parameter, variable value or to initiate a motion sequence. The master has continuous access to ACR parameters and flags. Simply assign an IP address to the ACR without any additional set-up to integrate into the network.

When advanced motion is required in a machine utilizing PLCs, the ACR EPL is an easy-to-integrate alternative. Let the ACR EPL be the "motion module" in the PLC system to handle complex motion requirements such as linear and circular interpolation, contouring, camming and gearing.

Class 1 and Class 3 CIP Messages are Supported by the ACR EPL

Class 1 (UDP) – I/O with Cyclic Updates Implicit messaging is a "Class 1" connection type, providing point-to-point or multicast messaging over a UDP connection. Typical applications use implicit messaging for I/O data transfer. Data is sent cyclically based on a user-defined duration. In most PLCs, the ACR EPL will be seen as an Ethernet based I/O block.

Class 3 (TCP) CIP Messages (connected and unconnected) Explicit messaging is a "Class 3" connection type, providing point-to-point, event-driven messaging over a TCP connection. The scanner/master PLC device reads and writes data to the slave. In a typical application, a function block in a ladder program would be used to send a message to the ACR to command or change motion.



ACR EPL...Solutions

Connectivity and communication features give the ACR EPL flexibility for use in a wide variety of machine architectures. The ACR EPL excels as a standalone machine and motion controller, interfacing with a PC or working alongside a PLC.

AcroBASIC

The ACR series of controllers utilizes a dedicated high-level programming language called AcroBASIC. This easy-to-use language supports a wide range of motion, I/O and communication functions. Several hundred intuitive pneumatic commands are incorporated into AcroBASIC for quick application development. The open nature of the ACR EPL appeals to advanced programmers as well. Virtually every possible motion parameter and flag can be readily accessed, allowing the user to tailor applications to the specific machine requirements.

Multi-Tasking

The ACR EPL controllers are true pre-emptive multi-taskers capable of performing multiple tasks simultaneously and toggling tasks based on the program conditions. The ACR multi-tasker can control up to 16 AcroBASIC programs and 8 ladder logic PLC programs simultaneously. Due to the pre-emptive nature of the multi-tasking kernel, programs are only allocated processing time when running. Programs can be called on an as-needed basis.

Motion Features

The ACR EPL is loaded with powerful motion functionality, including:

- Segmented electronic CAM
- Electronic gearing with real-time phase advance
- Linear interpolation of up to 8 axes
- Programmable limit switch with multiple sources
- Advanced gantry control
- 3D arcs and tangent axis control
- Hardware & capture registers
- Time-based moves

Fast Ethernet & USB 2.0

With the P1 or P3 options, the ACR EPL is equipped with both 100baseT Ethernet and USB2.0. ACR EPL supports connection of up to four separate devices over Ethernet or in combination with USB and RS232. Each ACR EPL has a programmable IP address so single or multiple controllers can be easily integrated in factory networks.

PC Centric Applications

In many machines, a host PC is responsible for management of the user interface, motion control, I/O, vision and other processes. For the OEM and end-users that require custom PC software, Parker supplies libraries for developing applications in C++, VB and .NET. The ComACRsrvr, a 32-bit OLE automation (COM) server, is included with the ACR-View Software Development Kit along with numerous sample applications. An extensive collection of functions is included to enable fast and stable communication, data sharing and motion.

With 100Mbps Ethernet, the ACR EPL becomes a viable alternative to controller cards installed in the PC. Installation, wiring and maintenance are greatly simplified and free up the PC slots for other devices.

Machine Control

Onboard and expansion I/O and the multi-tasking programming environment make the ACR EPL a powerful choice for stand alone machine control. The ACR EPL PLC programs incorporate a set of ladder-logic commands that can be running alongside the motion programs for more flexible error handling and I/O monitoring. A full 200-line PLC program is scanned every 2ms and a total of 8 programs can be included in the scan cycle.

With the expansion I/O port, the ACR EPL becomes a CANopen master and is able to control devices that follow the DS401 protocol for I/O devices. The CANopen expansion I/O supports up to 4 nodes and over 1000 digital points.

Adding devices such as operator interfaces and vision can be accomplished over Ethernet.

ETHERNET Powerlink MotionBus System

ACR-View Software Development Kit

ACR-View is a powerful project-development suite that assists the user of the ACR family products in programming, debugging and commissioning their application. Many features are incorporated to assist both the novice and expert users in developing code. All the tools needed to build and maintain a motion project are included:

- Ethernet, USB, CANopen and serial connection support
- Project Configuration Wizard
- Servo tuning tools
- Built-in oscilloscope, strip chart and XY plot
- Structured text program editor with color coded syntax checking
- Ladder logic program editor
- Real-time terminal interface
- Servo loop diagnostic tool
- Comprehensive status panels
- Integrated on-line help files

Configuration Wizard

Project set-up is streamlined through the use of the Configuration Wizard. The ACR EPL can be configured in a matter of minutes as the user is guided through a series of simple steps. ACR-View will set the necessary parameters to have the controller ready for motion and code development.

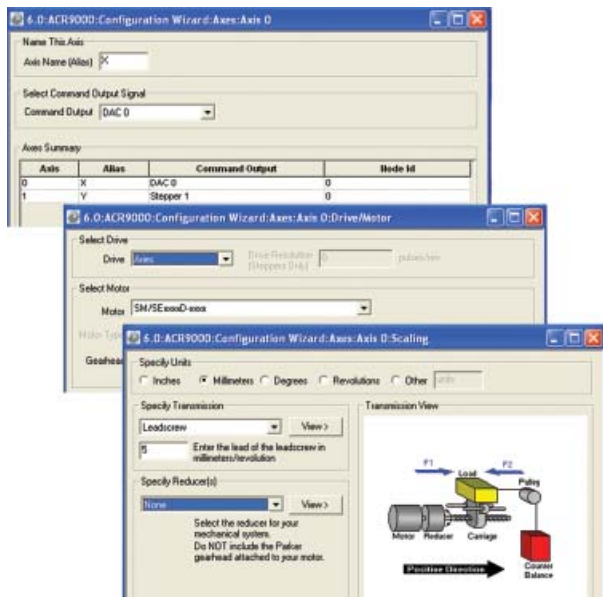

Terminal, Help and Project Tree

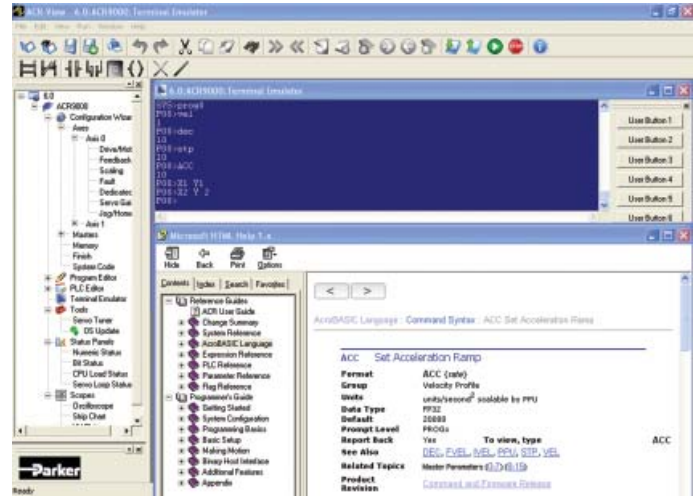

Commissioning

Within the Configuration Wizard is an easy-to-use commissioning tool. Quickly verify the key motion and hardware settings for each axis, such as direction, velocity and limit function. Users can then proceed to programming with confidence in the physical settings.

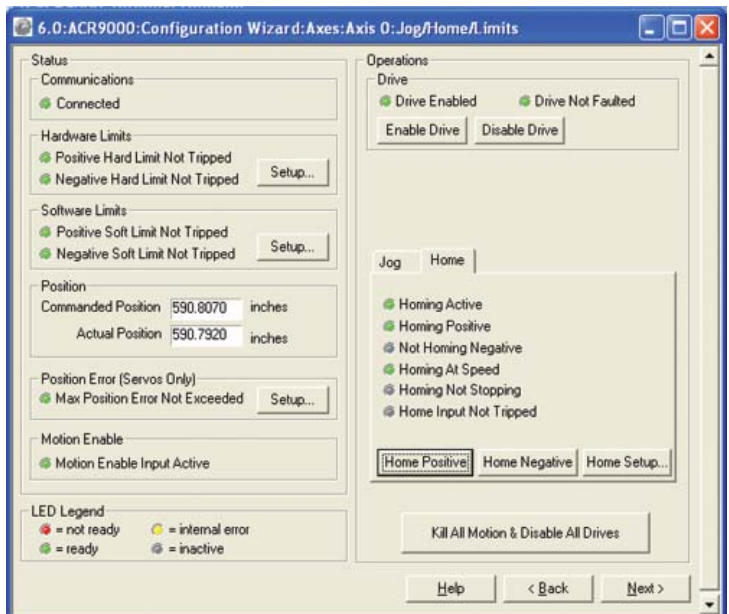



ACR-View Software Development Kit

Editors

Program and ladder editor tools allow straightforward development of both motion and I/O application code. Color-coded syntax checker assist in programming. PLC programs can be written in either ladder or text.

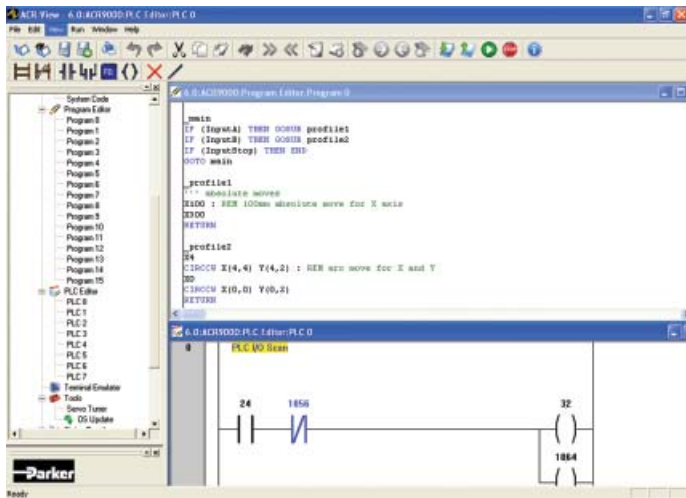

Tuning

Servo tuning can be optimized with ACR-View's powerful Oscilloscope feature. Up to four channels of data can be observed and stored. Tuning gains are updated best fit the needs of the application.

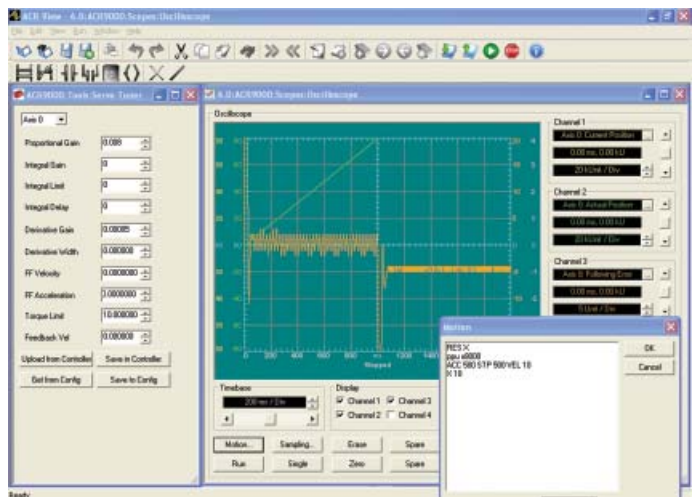

XY Plot

In addition to the Oscilloscope, ACR-View includes an XY Plot, which allows the user to display X vs Y positions for two pairs of axes at once. Easily visualize 2-D path, using any of the onboard position parameters.

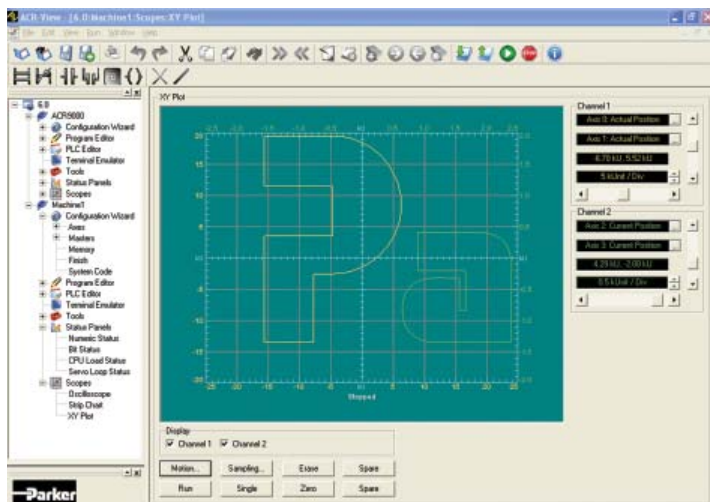

Status Panels

View virtually any parameter or flag within the controller using the Bit and Numeric Status panels. The Servo Loop Status panel allows in-depth analysis of servo operation.

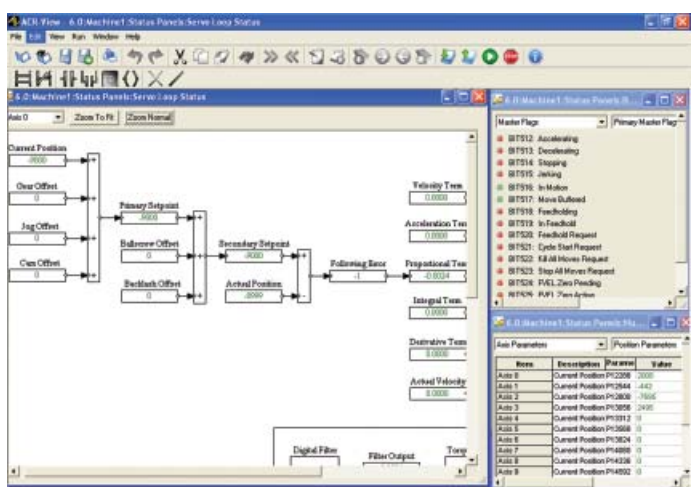

ETHERNET Powerlink MotionBus System

ACR MotionCOMponents Tool Kit

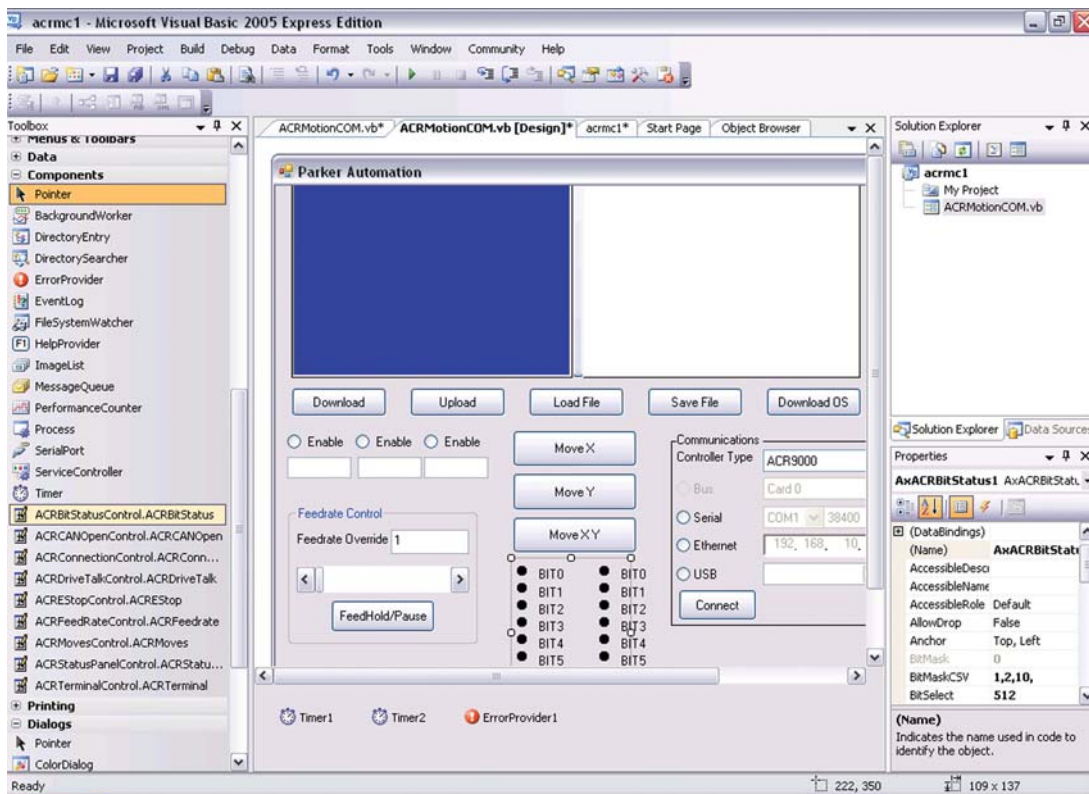

The ACR MotionCOMponents Tool Kit is an extensive collection of components and controls to allow a software developer to quickly and easily build a custom user interface for PC-based motion control applications. The tools incorporate a full set of ACR function calls, enabling complete control of any ACR family controller from a PC program.

Includes:

- Connection Control for Ethernet, USB, serial or PCI communication with any ACR controller
- Terminal Control for direct command input and file transfer
- Monitor Control for viewing the status of motion critical flags and parameters
- Teach Control for jogging axes and saving data to arrays
- Playback Control for running profiles created with the Teach Control
- CANopen Control for seamless integration of a CANopen network
- Bit and Numeric Status Controls for convenient display of any controller flag or parameter

- Moves Control for multi-axis motion commands
- DriveTalk Control for communication with Aries drives from the ACR EPL controller

ACR EPL Features:

- Available in both .NET and ActiveX versions
- 12 integrated tools containing more than 100 ACR function calls
- For use with all ACR series controllers
- Pre-built graphical controls for faster development
- Easy, hassle-free installation and set-up
- Functional User Interfaces can be developed in minutes
- Graphical objects include wrapper classes for greater convenience



ACR MotionCOMponents Tool Kit

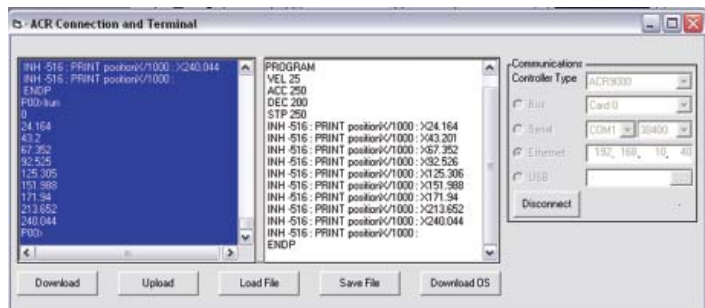

Connect and Talk

The Connection Control establishes communication to any ACR controller and is the main link for all other controls in a project. The Terminal Control allows the user to input commands and queries for immediate execution. Utilities are included for program transfer.

View and Monitor

The StatusPanel Control displays key motion parameters and flags in one convenient tool. Panels are also available to easily customize the polling of data from the controllers.



Jog, Teach and Play

The TeachPanel control is ideal for controlling basic motion functions. Includes homing and drive control, along with position data. This control allows the user to jog to fixed positions, and then capture the data in arrays for later playback. The Playback Control replays recorded positions for multi-axis coordinated motion.

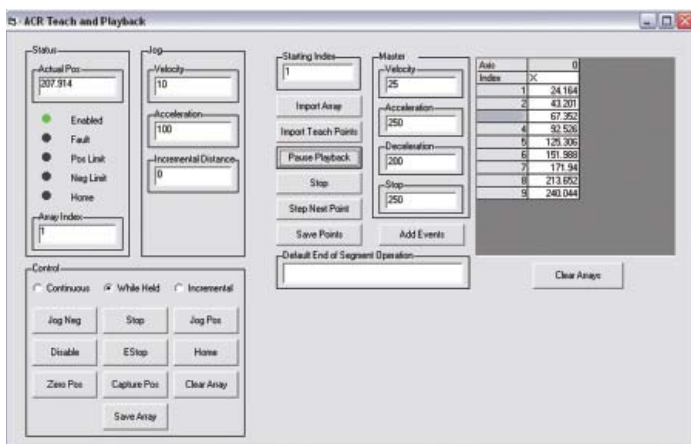

ACR MotionCOMponents Tool Kit is available for download, free of charge, at www.parkermotion.com/support.htm

ETHERNET Powerlink MotionBus System

ACR EPL Specifications

Hardware

Processor
User memory
Firmware
Operating system
Battery Backup

Performance

Multi-tasking
Trajectory update
Interpolation

Communications

ETHERNET Powerlink

Serial Interface
Ethernet
USB
CANopen

Software provided

Development Software
Language Support

Axes/controller

Power Requirement

Inputs/Outputs

Analog outputs
Stepper outputs
Encoder input

Digital Onboard I/O

General Purpose

High Speed Triggers
(1 μ sec capture time)

Outputs

Dedicated Axis I/O

ACR EPL Common Specifications

32-bit floating-point DSP @ 150 MFLOPS / 75 MHz
1 MB Flash-based. Retains user programs and system configuration parameters
Flash-based
Multi-tasking RTOS
Non-volatile memory retains all system and user variables.

8 coordinated systems/16 text programs/8 ladder programs
64-bit precision, 500 μ s (axes dependent)
Linear, circular, sinusoidal, helical, elliptical, spline, 3D arcs

ETHERNET Powerlink V2. Integrated 2-port Hub, RJ-45 connectors
Supports EPL DS402 Drives in Interpolated Position Mode
1 serial port (RS232 and/or RS422)
10/100 Base-T, RJ-45 connector. Supports IP Protocols TCP/UDP, EtherNet/IP
USB 2.0, Type B connection
Standard 9-pin D-Sub connector
Supports DS401 protocol for I/O devices (Optional)

ACR-View Software Development Kit
Libraries for C++, VB6, C#, VB.NET. MotionCOMponents ActiveX Tools

ACR9030

2,4, 6 or 8 servo/stepper axes
(max 16 total axes)
16 EPL Axes
90-240 VAC

16-bit resolution DAC, up to 8 outputs
Up to 8 @ 2.5 MHz maximum
Up to 10 at 20 MHz post-quadrature
Software configurable for Synchronous Serial Interface (SSI), quadrature, step and direction, CW/CCW modes

24 VDC optically isolated. Inputs support both NPN and PNP devices

12 general purpose inputs for 2 to 4 axes
40 inputs for 6 to 8 axes

8 trigger inputs for 2 to 4 axes
16 trigger inputs for 6 to 8 axes
4 outputs for 2 to 4 axes
8 outputs for 6 to 8 axes

Drive Enable, Reset outputs, Fault Input on axes connector for or servo/stepper axes

ACR9040

16 EPL Axes

24VDC, 1 amp

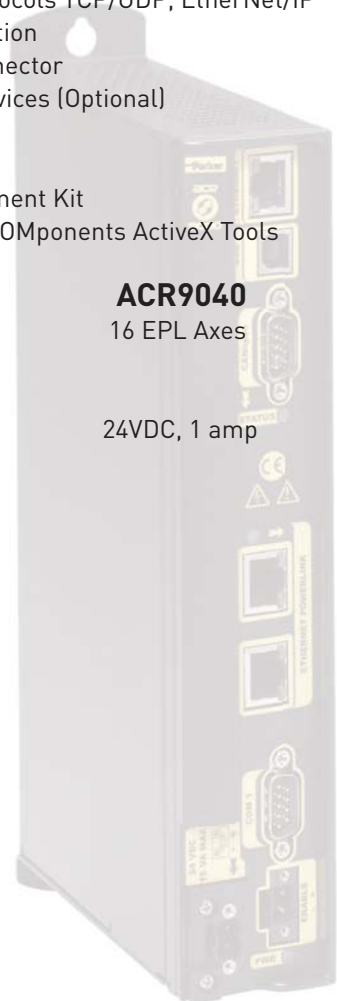



EPL Drive Specifications*

Part Number	Aries EPL	Compax3 EPL
Power Output		
Drive Current, continuous (A RMS)	3, 4.5, 6.3	SxxxV2 - 2.5, 6.3, 10, 15 SxxxV4 - 3.8, 7.5, 15, 30 HxxxV4 - 50, 90, 125, 155
Drive Current, peak (A RMS)	9, 13.5, 14.2	SxxxV2 - 5, 12.6, 20, 30 SxxxV4 - 7.6, 15, 30, 60 HxxxV4 - 75, 135, 188, 233
Commutation	Sinusoidal	Sinusoidal
PWM Frequency	16 or 32 kHz, motor dependent	8/16/32 kHz, model dependent
Power Input	120/240 VAC	SxxxV2 - 80-253 VAC SxxxV4 - 80-528 VAC HxxxV4 - 350-528 VAC
Control Power Input	120/240 VAC, required	24VDC, required
Performance		
Torque Loop update	62.5 usec	62.5 usec
Velocity Loop update	125 usec	125 usec
Position Loop update	125 usec	125 usec
Communications	Ethernet, ETHERNET Powerlink	RS232/485, ETHERNET Powerlink
Inputs		
Digital inputs	7 programmable inputs, 5-24VDC	8-20 programmable inputs, sinking, 24V nom. @10mA,
Analog inputs	N/A	Two (dedicated); 14-bit
Encoder input	2 MHz (pre-quadrature)	5 MHz (pre-quadrature)
Safety input		EN954-1 CAT3
Outputs		
Digital outputs	4 programmable outputs	4-16 programmable outputs
Analog outputs	N/A	Two (dedicated); 8 bit; software configurable as monitor outputs
Fault	5-24VDC	
Brake	solid state, NO, 1amp@24VDC max	NO, 1.6A@24VDC max
Feedback	Incremental encoder, smart encoder EnDat absolute encoder	Incremental encoder, resolver, EnDat and Hiperface absolute encoder
Environmental		
Temperature	0-45C (32-113F) except AR-13, 0-40C (32-104F)	0-45C (32-113)
Humidity	0-95%, non-condensing	0-85%, non-condensing
Regeneration	Internal capacitance, internal circuitry to accommodate external resistor	Internal capacitance, internal circuitry to accommodate external resistor
Standards	UL Recognized, CE (EMC), CE (LVD)	UL and cUL Recognized, CE (EMC), CE (LVD)

*More detailed specifications are available in the product manuals at parkermotion.com

ETHERNET Powerlink MotionBus System

ACR Part Numbering System

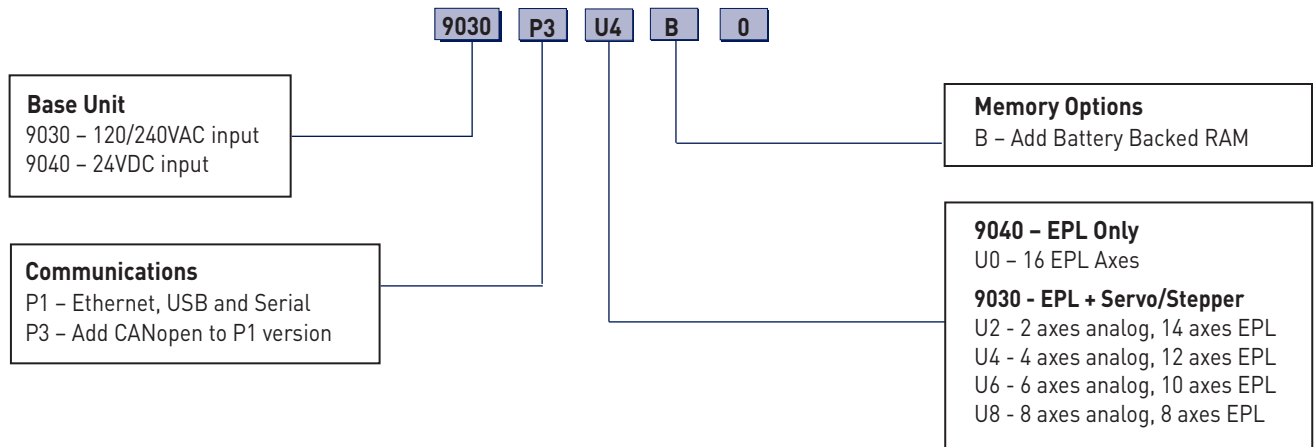

Example: 9030P3U4B0
12 Axes EPL + 4 axes servo/stepper controller (16 axes total) with Ethernet, USB, CANopen and BBRAM memory
All models include ACR-View Software Development Kit CD

Aries Part Numbering System

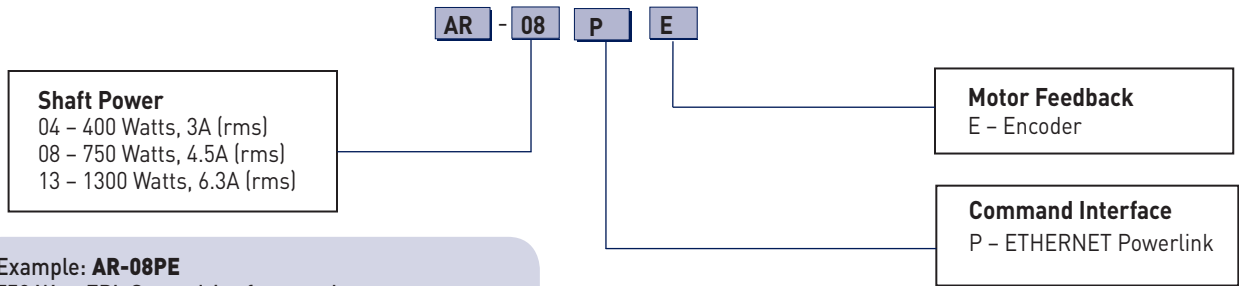

Example: AR-08PE
750 Watt EPL Servo drive for encoder motors

Compax3 Part Numbering System

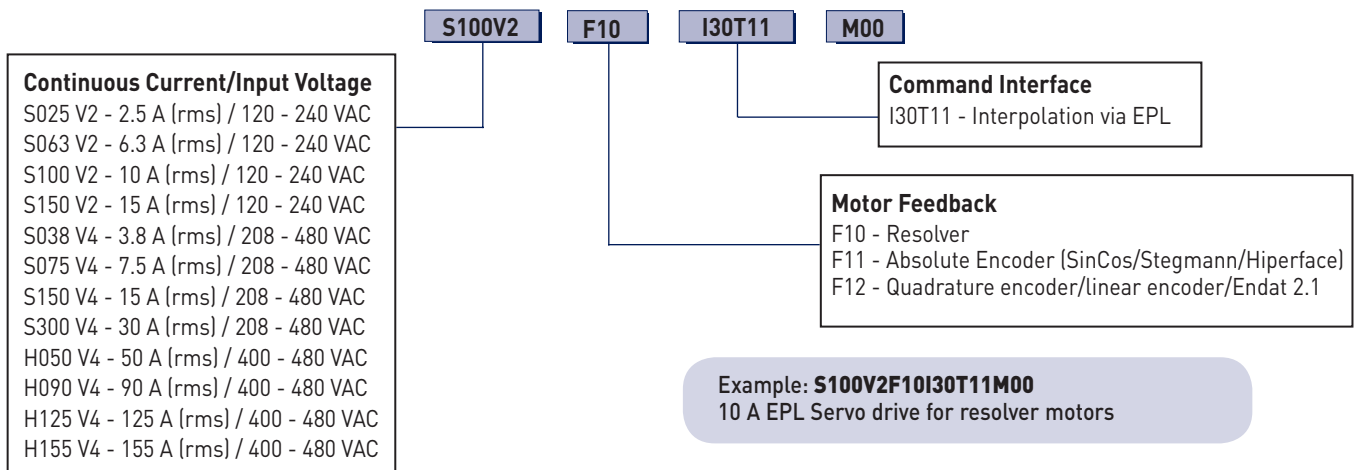

Example: S100V2F10I30T11M00
10 A EPL Servo drive for resolver motors



EPL System Dimensions					
ACR EPL Controllers		H	W	D	
ACR9030, 1 - 4 axis	in	10.50	3.58	5.30	
	mm	266.70	90.93	134.62	
ACR9030, 5 - 8 axis	in	10.50	5.00	5.30	
	mm	266.70	127.00	134.62	
ACR9040	in	10.42	1.75	5.30	
	mm	264.67	44.45	134.62	
Aries EPL Drives		H	W	D	
AR-04PE	in	8.07	3.01	5.35	
	mm	204.9	76.3	135.9	
AR-08PE	in	8.07	3.38	5.35	
	mm	204.9	85.9	135.9	
AR-13PE	in	8.07	4.38	5.35	
	mm	204.9	101.3	135.9	
Compax3 EPL Drives		H	W	D	
SXXX V2					
S025	in	7.52	3.31	6.77	
	mm	191.00	84.00	172.00	
S063	in	7.52	3.94	6.77	
	mm	191.00	100.00	172.00	
S100	in	9.76	4.53	6.77	
	mm	248.00	115.00	172.00	
S150	in	9.76	6.22	6.77	
	mm	248.00	158.00	172.00	
SXXX V4					
HXXX V4					
S038	in	9.76	3.94	6.77	
	mm	248.00	100.00	172.00	
S075	in	9.76	4.53	6.77	
	mm	248.00	115.00	172.00	
S150	in	9.76	6.22	6.77	
	mm	248.00	158.00	172.00	
S300	in	14.96	6.89	6.77	
	mm	380.00	175.00	172.00	
H050	in	17.83	9.92	9.65	
	mm	453.00	252.00	245.00	
H090	in	26.34	10.12	12.28	
	mm	669.00	257.00	312.00	
H125	in	28.35	10.12	13.98	
	mm	720.00	257.00	355.00	
H155	in	28.35	10.12	13.98	
	mm	720.00	257.00	355.00	

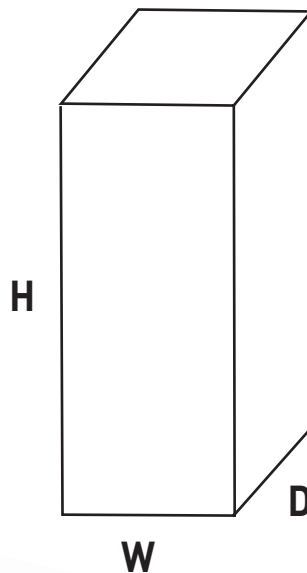

ETHERNET Powerlink MotionBus System

ACR EPL Accessories

Part Number

ACR EPL to EPL Drive Accessories

71-028656-XX

Accessory Description

Shielded Ethernet cable to Aries EPL drives
Cables offered in 1' (-01), 3' (-03), 5' (-05), 10' (-10), 25' (-25) lengths,
e.g., 71-028656-10

9030 to Analog/Stepper Drive Cables

71-021599-XX

71-021110-XX

71-021108-XX

71-023715-XX

71-021112-XX

71-022316-XX

71-021113-XX

71-022344-XX

ACR-to-Aries command cable (analog only)
ACR-to-ViX command cable
ACR-to-Compax3 command cable (analog only)
ACR-to-Dynaserv G3
ACR-to-Gemini command cable (analog only)
ACR-to-Gemini command cable (step & direction only)
ACR-to-stepper cable (25 pin stepper connector)
26-pin flying lead cable
Note: Cables offered in 4' (-04) or -10' (-10) lengths, e.g., 71-021599-04

Expansion I/O Cables

71-022338-02

71-022338-04

2' Expansion I/O cable (9-pin D-sub to flying lead)
4' Expansion I/O cable (9-pin D-sub to flying lead)

RS232 Communication Cable

71-016939-10

10' RS-232 communication cable

ACR9030 Breakouts

VM25

25-pin screw terminal breakout board for onboard I/O connector and Limit/
Home (2' cable included)

VM26

26-pin screw terminal breakout board for axes connectors, DIN rail mount
(2' cable included)

Aries EPL Breakouts

VM25

VM25-EPL

25-pin screw terminal breakout board for local I/O (2' cable included)
25-pin screw terminal breakout connector for local I/O - mounts directly to
D-sub connector on drive

VM15-PM

15-pin screw terminal breakout for feedback connector

9030 AC Power Adapter

43-011905-01

240 VAC Power plug adapter

Power Supply

PS-60W

24VDC, 60W power supply for I/O, enable and 9040 controller

Parker I/O System (Expansion I/O)

PIO-337

PIO Bus coupler, CANopen standard

PIO-347

PIO Bus coupler, CANopen economy

PIO-430

PIO 24 VDC digital input module, 8 channel

PIO-402

PIO 24 VDC digital input module, 4 channel

PIO-400

PIO 24 VDC digital input module, 2 channel

PIO-530

PIO 24 VDC digital output module, 8 channel, 0.5 Amp

PIO-504

PIO 24 VDC digital output module, 4 channel, 0.5 Amp

PIO-501

PIO 24 VDC digital output module, 2 channel, 0.5 Amp

PIO-468

PIO 0-10 VDC analog input module, 4 channel

PIO-480

PIO 0-20 mA analog output module, 2 channel, differential isolated

PIO-550

PIO 0-10 VDC analog output module, 2 channel

PIO-552

PIO 0-20 mA analog input module, 2 channel

PIO-600

PIO end module



ACR EPL...Partners

Rotary and Linear Motors

Parker offers a complete line of motor products meeting a broad range of application needs. Parker Trilogy's linear motors offer industry-leading solutions for both ironcore and ironless technologies. The wide range of rotary servo motors includes the high-torque MPP Series, the smooth/high-inertia SM Series and the cost-effective BE Series.

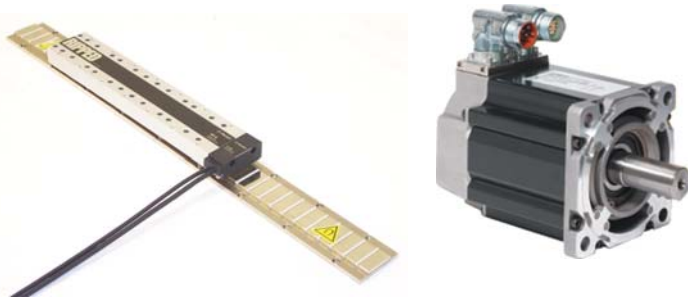

Daedal and Bayside Mechanics

Parker offers the widest range of precision mechanical actuators in the industry. The 400XR series of modular linear positioners is available in an unrivaled array of sizes, features and options. Single- and multi-axis systems combine with the unique ACR EPL features for performance and value.

Gantry Control: LOCK feature of ACR offers outstanding control of linear motor gantry systems. A dedicated feedback loop monitors and corrects the position of the parallel axes to maintain precise alignment.



PIO

The modular Parker I/O System (PIO) is a convenient and flexible product for connecting field devices to an ACR EPL. The PIO communicates with the controller via CANopen. A wide variety of digital and analog modules are available.

Features

- Opto-Isolated
- Compact, DIN-rail mount
- Easy to install and expand
- Safe, reliable contacting
- Different voltages can be combined
- Error and status LEDs



Ballscrew Compensation: Use the error map data provided with a precision grade XR table to improve accuracy with the powerful yet easy-to-use ACR compensation feature.

CTC HMI - Human Machine Interface

Parker's range of HMI solutions include cost-effective, dedicated HMI panels as well as flexible Industrial PC's running Windows based InteractX HMI software. Connectivity to the ACR EPL is supported via EtherNet/IP. Application development is simplified by programming in a familiar environment, including support for OPC, ActiveX and Visual Basic.



Parker Hannifin Corporation
Electromechanical Automation Division
5500 Business Park Drive
Rohnert Park, CA 94928
parkermotion.com