



Installation & Programming Manual



1080 North Crooks Road
Clawson, MI 48017-1097
Phone: (248) 435-0700
FAX: (248) 435-8120
Internet: www.ametekapt.com www.ametek.com

Preface

This manual is for the Installation and Maintenance of the Gemco Series 1995B Micro-Set Programmable Limit Switch.

**Copyright 2000 by AMETEK
All Rights Reserved - Made in the U.S.A.
Version 0.1**

AMETEK has checked the accuracy of this manual at the time it was printed. Any comments you may have for the improvement of this manual are welcomed.

AMETEK reserves the right to revise and redistribute the entire contents or selected pages of this manual. All rights to the contents of this manual are reserved by AMETEK.

Contents

Chapter 1: Introduction/Description	1
1.1 Programmable Features	1
1.2 General Information	1
1.3 Controller Features and Functions	2
Chapter 2: Installation	3
2.1 Mechanical Installation	3
2.2 Electrical Installation	4
2.3 Wiring Instructions	4
Chapter 3: Programming	5
3.1 Security Input	5
3.2 Initialization	5
3.3 Scale Factor	5
3.4 Number of Outputs	5
3.5 Selecting Number of Outputs	6
3.6 Multiprogram (Available Only on “P” Option Units)	6
3.7 Setpoint Formula	6
3.8 Setpoints	8
3.9 Clear an Existing Setpoint	10
3.10 Clear All Setpoints	10
3.11 Setpoint Availability	10
3.12 Electronic Offset	11
3.13 Motion Detector	11
3.14 Power-Up in a Position or RPM	12
3.15 Decimal Point Programming	12
3.16 Enable/Disable Outputs	13
3.17 Linear Speed Offset (Available Only on Option “P” Units)	13
3.18 Programming 1995 PLS for Linear Speed	15
3.19 Minimum Speed Disable	15
3.20 Time-Based Outputs (Available Only on Option “P” Units)	16
3.21 Brake Monitor Operational Description	17
Chapter 4: Expansion Modules	20
Chapter 5: Fault Check	21
5.1 PLS Output Status on Fault Conditions	22

Chapter 6: Security Inputs	23
Chapter 7: Remote Circular Display	24
7.1 POS/RPM On Remote Circular Display	24
Chapter 8: Troubleshooting	25
8.1 Preliminary Checks	25
8.2 Transducer Excitation Voltages	25
8.3 Electrical Noise and Power Quality Consideration	26
8.4 Grounding	26
8.5 Incoming Power	26
8.6 Low Level Inputs	26
Chapter 9: Specifications	28
9.1 1995 Micro-Set PLS Programmer	28
9.2 Mechanical Relay (Single Pole, Double Throw)	28
9.3 AC Solid-State (Single Pole, Normally Open)	28
9.4 DC Solid-State (Single Pole, Normally Open)	29
9.5 1995E Output Expansion Module	29
9.6 1995-1446 Remote Circular Display	29
Chapter 10: Troubleshooting Guide	30
Chapter 11: Wiring Diagrams	33

Chapter 1: Introduction/Description

The **1995B Micro-Set** is a fully self-contained, single-turn resolver-based programmable limit switch. It includes a three-digit LED display, five output relays, and one fault check relay, and it is fully programmable for the following features:

1.1: Programmable Features

Scale Factor	There is one scale factor only, permanently set to 360.
Electronic Offset	Fully programmable offset to any number with the scale factor.
Motion Detector	LS5 can be programmed for either limit switch or motion detect output.
Expansion Outputs	Programmable to accommodate up to 29 circuits.

See Section 1.2: General Information - Software Option “P” for more options.

1.2: General Information

The **1995B Micro-Set** is a fully self-contained, microcomputer-based Programmable Limit Switch (PLS) with a convenient keypad for programming each independent output circuit to open or close at the desired settings. This system allows precise position control of rotary motion.

A **1995B** consists of a resolver-based transducer, resolver-to-programmer cable assembly, and the programmer, which provides five limit switch outputs, one fault check output and one brake monitor output. The optional output expansion modules will add six additional limit switch outputs per module, and up to four expansion modules can be driven by the programmer, for a total of twenty-nine limit switch outputs.

The single-turn resolver transducer generates a ratiometric analog signal representing an absolute rotary position. This ratiometric signal is converted to a digital signal at the Micro-Set. A microprocessor calculates and/or converts these signals based on user-programmed data.

As the transducer passes through the preprogrammed dwell settings, the programmer outputs can energize solenoids, relays, or solid-state circuitry to control external circuits.

The **1995B PLS** was designed for use in rotary and/or rotary-to-linear applications. It incorporates many features for safe, efficient operation.

The completely self-contained unit can operate up to 29 independent outputs (five standard) based on the rotary position of the resolver.

It offers an on line fault check which provides an automatic, in-process mechanism to verify that all major programmable limit switch functions are operating properly. The fault check output can be energized by activating the fault check enable input. The output is a mechanical relay with 1 N.O. and 1 N.C. contact, which remains energized during normal operation. A programmable motion detect output will energize a relay when the transducer speed meets or exceeds the customer-preprogrammed RPM value.

Also offered is an on-line brake monitor that checks the stopping time of the machine against a customer selected preset stopping time in milliseconds, and which can be used to check the stopping distance at any point in the stroke. A dedicated output remains energized when the stop time parameters are within tolerance. An excessive stop time will cause the relay to de-energize, which could be used to stop further machine operation.

SOFTWARE OPTION “P” ENHANCES THE SYSTEM BY OFFERING:

- **Multiple Programs** - Allow storage of job setups for future use. This saves time spent reprogramming and lessens the chance of programming errors when tooling is changed.
- **Speed-Induced Offsets** - On many variable speed machines, the limit switch outputs have to be adjusted when the speed increases or decreases. This option automatically adjusts specified circuits based on speed.
- **Time-Based Outputs** - Specified outputs can be programmed to turn on based on position and turn off based on time (0.01 - 9.99 seconds).

1.3: Controller Features and Functions

The controller is housed in an all metal case that can be panel mounted. The controller consists of a keypad, a CPU Board, and a Power Supply I/O Board.

The following features are found on the **1995B Micro-Set**.

- **Display** A (3) three-digit LED readout and a 10-place bar graph are provided. The LED readout displays current angular position and/or RPM and programming details, while the bar graph shows fault check, program status, and limit status.

NOTE: The Bar graph will not display expansion board relay status.

- **I/O** Mechanical relays, AC solid-state, and DC solid-state relays are available, and any combination can be specified. The example in the catalog shows three AC and three DC solid-state relays being specified. There is a fixed price adder for any combination of relays other than all mechanical (6M). The fault check relay will always be a mechanical relay regardless of the type of output relays specified. See Chapter 9: Specifications.

Chapter 2: Installation

This section describes the installation and wiring of a standard **1995B Micro-Set PLS**. Changes to these instructions should be made as necessary if special options and/or equipment are used.

The **1995B Micro-Set** should be installed in an area free of water spray, corrosive gases, flying chips or other foreign matter. The operating temperature should be between 32 and 125 degrees Fahrenheit, with less than 95% relative humidity.

2.1: Mechanical Installation

Mounting the 1995 Micro-Set PLS

The **1995B Micro-Set PLS** is designed to be panel mounted. The face of the **1995B** can be affected by water and/or oil spray. Provisions should be made to protect the face of the unit from spraying or splashing.

Panel cutouts, mounting holes, and sizes for each component are shown on Pages 6 and 7 of the **1995B** catalog section.

The controller should be mounted in the appropriate panel cutout and securely bolted into place using the four (4) 3/16" diameter mounting holes.

NOTE: In instances where the **1995B** is being mounted directly on a mechanical stamping press, care should be taken to isolate the controller from shock load and vibration.

It is always good design practice to mount the controller in the enclosure as far away from the motor starters and control relays as possible to minimize the effects of electromagnetic interference (EMI).

Interconnecting wiring also should be routed to minimize EMI coupling.

Mounting the Transducer

The proper mounting of the resolver transducer is critical to ensure the system's accuracy. There are two resolver transducers available.

- (A) Standard foot mount resolver transducer. The foot mount resolver transducer should be mounted in an area free of excessive shock and vibration (as is commonly seen by mounting plates that extend over the edge of the press). The resolver transducer should be connected in a 1:1 ratio with the crank. If a double-ended cam limit switch is available, it is preferable to mount off of the rear shaft

NOTE: The Micro-set programmable limits are not control reliable for the clutch/brake circuits. Mechanical cam limits must be used for these circuits.

- (B) Combination mechanical cam/resolver systems. Intended as bolt-in replacements to existing switches. The cam/resolver combination unit should be coupled where the existing limit switch is located. Wire and adjust the mechanical cams in accordance with the original press manufacturer's specifications and wire the resolver cable to the controller.

2.2: Electrical Installation

The **Micro-Set** is designed for use in an industrial environment and incorporates extensive transient suppression circuitry. However, the same general installation rules should be followed that are used on all microprocessor-based equipment. Incoming AC lines should be from a clean power source and lines carrying computer level signals should not be routed in the same conduit as high voltage, transient-producing circuits such as variable speed drives, welders or DC switching circuits.

The **1995B PLS** is only used with a single-turn resolver. Wiring for this system is shown in Fig. 11-2, Chapter 11: Wiring Diagrams. This wiring diagram is applicable for all standard 1995 PLS's.

2.3: Wiring Instructions

Attach the pre-wired plug on the resolver transducer cable to the transducer and route the shielded cable through a separate grounded (earth ground) metal conduit to the panel. Connect the mating half terminal block to the **1995B PLS**. Be sure the shield wire is connected to Pin 1 of the 16-place connector.

When extension to the factory supplied cable is necessary, a junction box should be used to connect the wire leads and the cable shields from one cable to the other. The cable shield should be grounded at the **1995 Micro-Set only**.

AC line voltage - 115V AC \pm 10% 50-60 Hz - should be connected to the **1995B PLS** at the "AC power" terminals on the 24-place connector.

Chapter 3: Programming

3.1: Security Input

The security input is often referred to as the “Run/Program” input. This input is located on the 16-place terminal strip and is discussed in Chapter 4: Expansion Modules. This input prevents unauthorized changes to the programmed functions. With the unit in the “Program” mode, all functions of the controller can be programmed. With the unit in the “Run” mode, all setpoints, motion detect and other operational functions can be verified, but the programmed information cannot be changed.

3.2: Initialization

The following key commands - - - - should be entered on the keypad to clear all programmed data upon installation and **PRIOR** to programming. This sequence clears all programmed data. All operating parameters must be reprogrammed after using this initialization function.

3.3: Scale Factor

The **1995B** is available only with a 360 degree scale factor, set permanently.

3.4: Number of Outputs

The **1995B** comes programmed for five outputs, but it is expandable to 29 outputs. However, when using a Remote Circular Display, the maximum will be 23 outputs.

3.5: Selecting Number of Outputs

Selection of the number of outputs should be done after the system is initialized and , and before any other programming is done. See Chapter 4: Expansion Modules.

A) To program the number of outputs desired, the unit must be in the Program mode, then depress **CIR#** - **1** - **7** - **7** - **ENT**. The unit will then show the number of circuits previously stored. To change the number of outputs desired, enter the number of relays in multiples of six and depress **ENT**.

- 1) Valid numbers for **CIR#** - **1** - **7** - **7** - **ENT** are **6**, **12**, **18**, **24**, and **30**. Remember, if using a Remote Circular Display, the maximum number of outputs is 23.

NOTE: If a number is entered that is not a multiple of six, the unit will store the next multiple of six.

3.6: Multiprogram (Available Only on “P” Option Units)

The Multiprogram feature allows the storage of multiple sets of output sequences that are preprogrammed based on the various requirements of different tooling. When dies or tooling are changed, the new program is simply called up on the keypad and all outputs are automatically set to the new output sequences. The number of available programs will vary based on the number of output limits and the number of setpoints programmed on each limit. A typical five-limit system with one “ON” and one “OFF” setpoint per output will be capable of storing twenty programs in memory

A setpoint is one “CIR ON” or “CIR OFF” entry. The following formula shows the relationship between the number of output relays, the number of programs, and the number of setpoints available per program.

3.7: Setpoint Formula

$$\text{Setpoint/Programs} = \frac{1467}{\text{Number of Programs} \times A} - 2$$

Where: A = 5 for 5 outputs
 = 6 for 11 outputs
 = 7 for 17 outputs
 = 8 for 23 outputs
 = 9 for 29 outputs



Setpoints are in whole numbers (drop decimal).

Example: 12 outputs relays with 10 programs:

$$\text{S.P.} = \frac{1467}{10 \times 6} - 2 = 24.45 - 2 = 22 \text{ Setpoints/Program}$$

The following table shows the relationship between the number of outputs, the number of programs, and the number of setpoints per program. The table only shows a few of the many combinations that are possible. Before programming outputs, it is advisable to verify that enough setpoints are available, otherwise the number of programs may need to be reduced. A setpoint is one “CIR ON” or “CIR OFF” entry.

5 OUTPUTS	11 OUTPUTS	17 OUTPUTS	23 OUTPUTS	29 OUTPUTS
1/253	1/242	1/207	1/181	1/161
20/12	9/25	5/39	4/43	2/79
26/9	12/18	8/24	5/34	3/52
36/6	17/12	10/18	7/24	5/30
97/1	27/7	13/14	8/20	6/25

Number of program   Resulting in number of setpoints per program.

Programming 1995 PLS for Multiprogram

- A) Specify the number of programs desired, unit must be in the “Program” mode. Depress - - - - - - - . See above table for the capabilities of your unit.
- B) Upon entering the above sequence, depressing the key will display the maximum amount of setpoints per program.

NOTE: A time-based output uses up three setpoints.

- C) $\boxed{\text{CIR\#}} - \boxed{7} - \boxed{7} - \boxed{2} - \boxed{\text{ENT}}$ will display the total number of setpoints available for use in the currently selected active program.
- D) To display the active program, depress $\boxed{\text{CIR\#}} - \boxed{7} - \boxed{7} - \boxed{1} - \boxed{\text{ENT}}$.
To change programs, with the unit in the Program mode, depress $\boxed{\text{(0 thru Highest Program Number)}} - \boxed{\text{ENT}}$.

NOTE: Program 0 is the first program. If 10 programs were previously selected using Code 770, there will be programs 0-9.

3.8: Setpoints

Programming New Setpoints

- A) Unit must be in the “Program” mode.
- B) Select a limit switch circuit for programming. Depress $\boxed{\text{CIR\#}} - \boxed{\text{(1 thru 30)}} - \boxed{\text{ENT}}$. The circuit number selected cannot exceed the number of output relays specified earlier using CIR# 177. See Section 3.5: Selecting Number of Outputs.
- C) Depress $\boxed{\text{CIR ON}} - \boxed{\text{(Desired Pos)}} - \boxed{\text{ENT}}$. This will set the selected relay turn-on point.
- D) Depress $\boxed{\text{CIR OFF}} - \boxed{\text{(Desired Pos)}} - \boxed{\text{ENT}}$. This will set the selected relay turnoff point.
- 1) On units where time-based circuits have been selected, the $\boxed{\text{CIR OFF}}$ will be the time interval that the relay will be active once the ON setpoint has been reached.
- E) Multiple ON and OFF setpoints can be programmed on each circuit. All decimal points will flash when more than one setpoint exists on the selected circuit.
- F) An LS (Limit Switch) may not have the same value for both the ON point and the OFF point. If a value is entered that is already a setpoint for that LS, only the new one will be used. For example: If LS1 had an ON point at 100 and an OFF point of 100 was entered, the ON point at 100 would be deleted, and the OFF point would then take its place. Assuming that these were the only setpoints, the output would turn ON at 0 and OFF at 100.

The programmable limits are programmed based on “dwell on” and “dwell off” locations. The “dwell on” typically represents the location at which a selected limit turns on and the “dwell off” represents the location at which the limit turns off. The position locations for the “dwell on” and “dwell off” are based

on a scale factor corresponding to the 360-degree rotation of the resolver. Example: In the foregoing example, with a 360 scale factor, a “dwell on” of 0 and a “dwell off” of 100 would look like this:

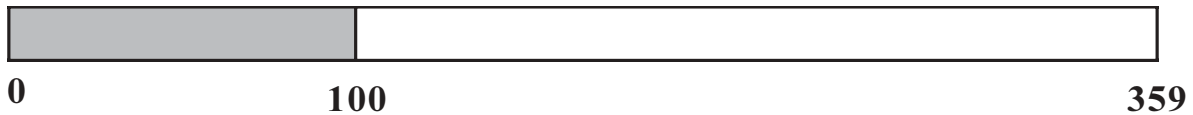

The shaded area represents the area where the selected limit output relay is energized. Programmable limit switch outputs offer a unique function which normal rotating cam limits cannot, namely, the ability to turn a limit on or off more than once in a 360-degree cycle. Multiple dwells allow several “dwell on” and “dwell off” values to be programmed for a particular limit. Example: “Dwell on” settings of 20, 100, 200, and “dwell off” settings of 80, 180, 270 would look like the following:

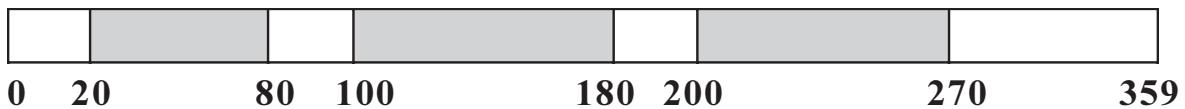

Another feature of programmable limits is the ability of programming a “dwell on” or a “dwell off” only. If only a “dwell on” setting is programmed, the output will activate at the “dwell on” setting and remain on to 359 degrees. Example: “Dwell on” setting of 180 and “dwell off” not programmed will result in the following:

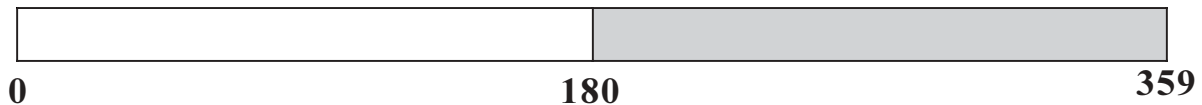

Conversely, if only a “dwell off” setting is programmed, the output will activate from 0 degrees to the “dwell off” setting. Example: “Dwell on” not programmed, “dwell off” set at 180 degrees will result in the following:

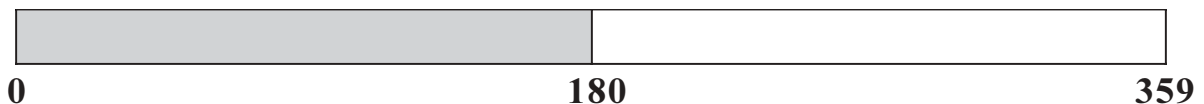

The programmable limits also have the ability to “shift” the dwells to turn on sooner. This can be done to compensate for mechanical lag in the devices they are controlling as the machine speed increases. (See Section 3.17: Linear Speed Offset for more details). Limits can also be programmed to turn off based on timed settings.

3.9: Clear an Existing Setpoint

- A) Unit must be in the “Program” mode.
- B) Depress - - .
- C) Depress or key until setpoint to be cleared is on the display.
- D) Depress the key. Upon depression of the key, the setpoint on the display after Step C is deleted.
- E) This keypad sequence must be completed once to clear an ON setpoint and a second time to clear the OFF setpoint. See Section 3.8: Setpoints

3.10: Clear All Setpoints

There are two methods of clearing all setpoints. This is accomplished as follows:

- A) Unit must be in the “Program” mode.
- B) To clear all of the setpoints in the active program, depress: - - - .
The active program is the program currently selected using Code 771. See Section 3.7: Setpoint Formula.

-OR-

- C) To clear all the setpoints in all programs, depress: - - - - .

NOTE: CIR# 91 and CIR# 391 only clear out programmed setpoints. They do not clear out Linear Speed ramps or change circuits that have been selected as Linear Speed or Time-Based; however, they will clear the setpoints programmed in these circuits.

3.11: Setpoint Availability

Every 1995 PLS has a limit on the number of setpoints that can be stored in memory. On units with the Multiprogram option, refer to Section 3.7: Setpoint Formula to calculate the maximum amount of setpoints available.

On units without Multiprogram, setpoint availability is dependent on the number of outputs enabled.

5 Outputs = 253 Setpoints Available
11 Outputs = 242 Setpoints Available

17 Outputs = 207 Setpoints Available
 23 Outputs = 181 Setpoints Available
 29 Outputs = 161 Setpoints Available

Refer to the Section 3.5: Selecting Number of Outputs.

3.12: Electronic Offset

The offset key is used to synchronize the digital display with the actual machine position. The **Series 1995B PLS** has full scale factor offset capabilities, and the offset is held in nonvolatile memory. However, to eliminate possible problems in the event that a replacement PLS is required, it is good practice to mechanically synchronize the resolver with the machine and then use the offset key to make final, fine-tune adjustments.

Programming the Electronic Offset

- A) Unit must be in the “Program” mode.
- B) Stop machine at a known location.
- C) Depress - - . After this sequence is completed, the display will change to the position entered. The display and outputs are now synchronized with the actual machine position.

3.13: Motion Detector

A programmable Motion Detect output will energize a relay when the transducer speed exceeds the customer’s preprogrammed RPM value.

The motion detector is set by entering the following:

- A) Unit must be in the “Program” mode.
- B) The motion detect must first be enabled before you can store any values. To accomplish this, depress - - - - - . A one (1) will enable the motion detect circuit, and LS5 will now be your motion detect output relay. If a zero (0) is entered, the motion detect feature is disabled and LS5 will function as a normal limit switch.
- C) To set the value at which the motion detect relay energizes, depress - - - - - - .

NOTE: A CIR #176 can only be entered if the motion detect option is enabled.

3.14: Power-Up in a Position or RPM

The **1995B** can power up displaying either Position or RPM data.

The power-up mode is programmed by entering the following:

- A) Unit must be in the “Program” mode.
- B) Depress - - - - - - . If a zero (0) is entered, positional data will be displayed upon power-up; if a one (1) is entered, the unit will power up displaying RPM.

3.15: Decimal Point Programming

A continuous, nonfloating decimal point may be programmed on the display. If a scale factor is selected that needs a decimal point in order to properly display its resolution in engineering units, the following 50 series codes are used:

50 - No decimal point; clears existing decimal point	123
51 - Tenths	12.3
52 - Hundreths	1.23

To program a decimal point, enter the following:

- A) Unit must be in the “Program” mode.
- B) Depress - or or - .
- Example:
- | | | |
|---------|---|------|
| CIR# 50 | = | 123 |
| CIR# 51 | = | 12.3 |
| CIR# 52 | = | 1.23 |

3.16: Enable/Disable Outputs

During setup, the outputs may be enabled or disabled. When outputs are selected to be disabled, the status LEDs and the relays will be OFF. The unit must be in the Program mode to disable the outputs; as soon as the unit is switched to the Run mode, the outputs will be enabled.

The enable/disable feature is programmed as follows:

- A) Unit must be in the “Program” mode.
- B) Depress - - .

CIR# 380 Enables the Outputs.

CIR# 381 Disables the Outputs.

NOTE: If you try to disable the outputs in the Run mode, the unit will display “EEE”.

3.17: Linear Speed Offset (Available Only on Option “P” Units)

This feature allows limit switch outputs, one through five, to be programmed to automatically advance and retard as machine velocity varies. The number of circuits affected by speed offset, the amount of offset, and the RPM range over which the offset develops are all keypad programmable. The amount to offset per RPM change will be the same for all outputs selected for this type of operation. This feature is used to compensate for the mechanical lag in machine controls.

The 16-step linear speed offset feature allows up to 16 different offset steps to be selected and a different amount of positive or negative (advance or retard) offset to be programmed between each of the sixteen steps.

Access Codes 501 through 516 are used to select the successive steps that define a ramp between the various offset values. That is, Code 501 is used to access and program the ramp between 0 RPM and the RPM value assigned to the first step; Code 502 is used to access and program the ramp between the RPM value of the first step and the RPM value assigned to the second step; and so on.

After using the access code to call up a step for programming, the CIR ON key is depressed, followed by the total amount of offset (from zero offset) to be applied to the circuit at the specified RPM value. The CIR OFF key is depressed next, followed by the RPM value of that step. The programmed offset value will be the total amount of offset being applied to the circuits from their zero offset starting values. This allows the circuits to be advanced or retarded between any two steps. See Section 3.18: Programming 1995 PLS for Linear Speed.

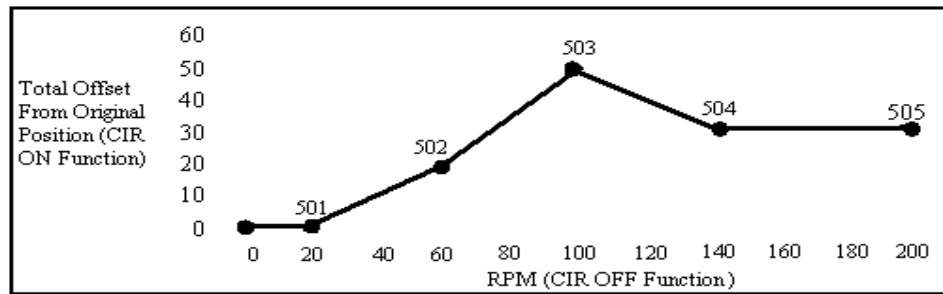

The graph above shows an example of five steps of linear offset in which the output circuits remain the same in the first step, then are being advanced in the next two steps, retarded between the third and fourth, and remaining unchanged between the fourth and fifth. The first step (501) is programmed so that the outputs will not be affected until after 20 RPM. Then the second step (502) is programmed to linearly advance the selected outputs by 20 degrees between 20 and 60 RPM. Circuits originally programmed to turn on at 150 degrees and off at 350 degrees will be turning on at 130 degrees and off at 330 degrees while at 60 RPM. The third step (503) is programmed to advance these same outputs to a total of 50 degrees as RPM rises between 60 and 100 RPM. The example circuit mentioned above that was originally programmed to turn on at 150 degrees and off at 350 degrees will now be turning on at 100 degrees and off at 300 degrees while at 100 RPM. The fourth step (504) is programmed to retard the circuits back to a total of 30 degrees as RPM continues to rise from 100 to 140 RPM. The example circuit, originally programmed to turn on at 150 degrees and off at 350 degrees is now turning on at 120 degrees and off at 320 degrees while running at 140 RPM. The fifth step (505) is programmed to maintain a fixed 30 degrees of total offset between 140 and 200 RPM.

NORMAL PLS DWELL

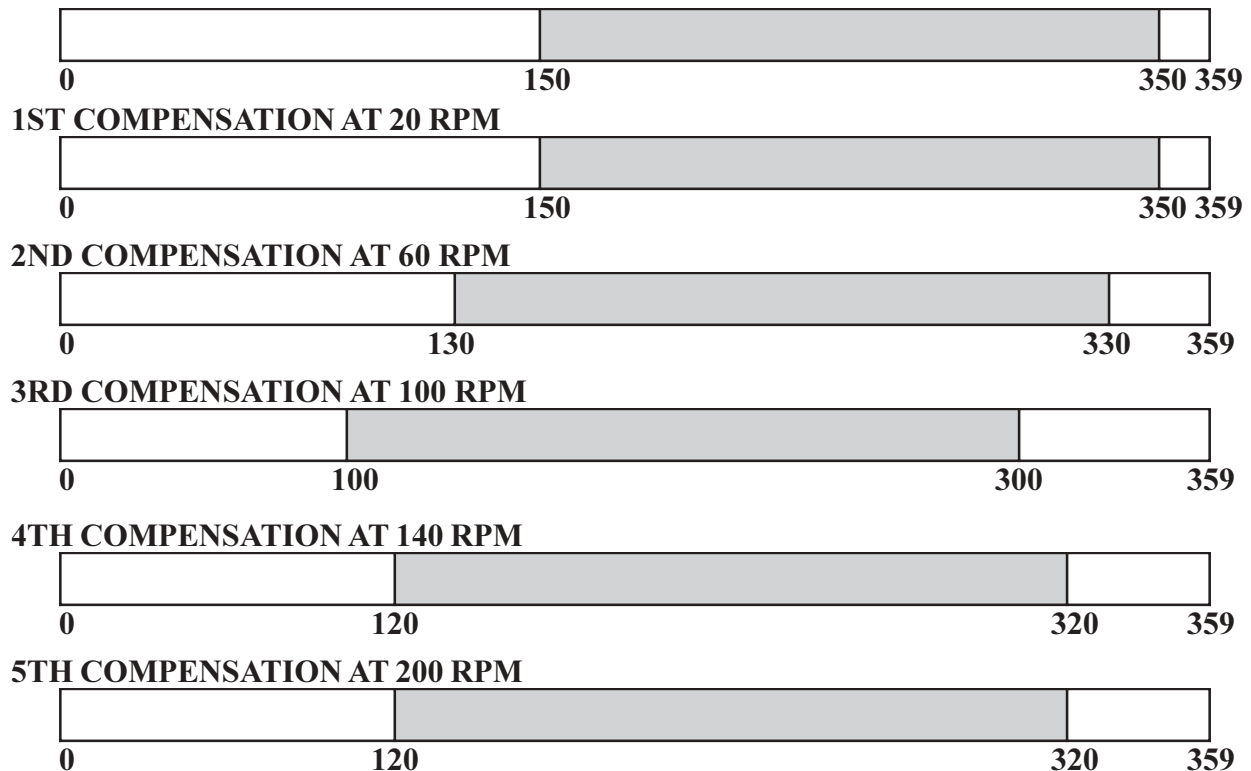

The offset (advance or retard) is applied linearly between each step, and the offset follows the same curve as RPM decreases. Example: At 80 RPM, offset value would be 35°.

3.18: Programming 1995 PLS for Linear Speed

- A) Unit must be in the “Program” mode.
- B) Select the number of circuits that will be offset based on RPM. The affected circuits will always start with CIR# 1 and will follow in ascending sequence to the number specified. Depress:
 [CIR#] - [80] - [ENT] - [(1 thru 5)] - [ENT] .

NOTE: LS5 cannot be programmed for Linear Speed if it is set for Motion detect. See Section 3.13: Motion Detector

NOTE: On units built prior to November 1, 1990, the Linear Speed Offset had only a single ramp offset.

CIR# - 81 - ENT - CIR ON = Offset Amount

CIR# - 81 - ENT - CIR OFF = RPM Value

Codes 501 - 516 will result in a programming error on this older software.

- C) Starting with Circuit 501, program the amount of offset and RPM point for the first offset ramp. Next use Circuit 502 to program both values for the second offset ramp. Continue with Circuit 503 and onward in ascending order until all desired ramps are programmed.
- 1) [CIR#] - [501 thru 516] - [ENT] - [CIR ON] - (Specify the total amount of offset from the original output settings) - [ENT] .
 - 2) [CIR#] - [501 thru 516] - [ENT] - [CIR OFF] - (Specify the RPM at which the above specified amount of offset occurs.)

NOTE: If “CIR# 501” - “CIR OFF” is set to zero, all linear speeds will be disabled.

3.19: Minimum Speed Disable

The Minimum Speed Disable sets the minimum speed at which the Linear Speed will affect the outputs. Below the programmed speed, the Linear Speed outputs will not be enabled.

The Minimum Speed feature is programmed as follows:

- A) Unit must be in the “Program” mode.
- B) Depress [CIR#] - [85] - [ENT] - [(RPM Value)] - [ENT] . This sets the Minimum Speed at which the Linear Speed will affect the outputs. Below the programmed speed, the Linear Speed outputs will not be enabled.

3.20: Time-Based Outputs (Available Only on Option “P” Units)

In instances where it is desirable to have an output actuate based on crank position and turn off based on time, we offer time-based limits. Examples of areas where time-based limits are applicable include lubricators and air blow-off limits. Even if the press stopped in the limit “dwell” area, it would only stay energized for a specific time period, eliminating potential waste. Circuits one through five can be selected for this type of operation. Circuits cannot be programmed for **Linear Speed Offset** and **Time-Based** outputs at the same time; thus the total combined number of **Linear Speed Offset** and **Time-Based** outputs cannot exceed five.

NOTE: CIR# 301 thru 305 only enable the circuit so that it can be programmed for a **Time-Based** output. After **Time-Based** circuits are enabled, see Section 3.8: Setpoints.

The **Time-Based** feature is programmed as follows:

- A) Unit must be in the “Program” mode.
- B) Depress $\boxed{\text{CIR\#}}$ - $\boxed{(301 \text{ thru } 305)}$ - $\boxed{\text{ENT}}$ - $\boxed{(0 \text{ or } 1)}$ - $\boxed{\text{ENT}}$.

CIR# 301 represents CIR# 1, CIR# 302 represents CIR# 2, etc. A zero (0) after CIR# 301-305 means that the circuit will function as a normal limit switch as outlined in Section 3.8:

Setpoints; however, if a one (1) is entered in after CIR# 301-305, it means that the circuit is to be set up for a position ON and a timed OFF output.

- C) This sequence only enables or disables LS1 thru LS5 for **Time-Based** operation. After an LS is enabled as a **Time-Based** circuit, follow normal programming instructions. See Section 3.8: Setpoints, C and D.

NOTE: If LS5 is set as a motion detector, it cannot be set for **Time-Based**.

- D) A **Time-Based** output may only have one CIR ON and one CIR OFF setpoint. This output will turn on based upon the CIR ON position data and will turn OFF based upon the CIR OFF time data, which is displayed and programmed in 0.01 second increments. A **Time-Based** output uses three setpoints. See Section 3.7: Setpoint Formula.
- E) Outputs 1 through 5 may incorporate **Linear Speed Offset** or may be **Time-Based**. However, no output can be both. In addition, LS5 may be selected to be a motion detect output. If two or three types of outputs are required, first select the number of **Linear Speed** circuits required (CIR 80) and then individually select the **Time-Based** outputs and **Motion Detect** output.

Example: Outputs 1 & 2 **Linear Speed**
CIR = 80 - ENT - 2 - ENT

Output 5 **Motion Detect**
CIR = 55 - ENT - 1 - ENT

Outputs 3 & 4 **Time-Based**
CIR = 303 - ENT - 1 - ENT
CIR = 304 - ENT - 1 - ENT

3.21: Brake Monitor Operational Description

The 1995B Brake Monitor PLS offers an on-line monitor which checks the stopping time of the press against a customer selected preset stopping time in milliseconds, and can be used to check the stopping distance at any point during the stroke.

With keypad commands, the digital readout will display the stopping time (CIR #174) or the stopping distance (degrees) (CIR# 175) of each cycle. If the time from deenergization of the press clutch voltage to stopping the ram exceeds a customer's programmed value, the brake monitor output relay will de-energize which can be used to stop further press operation. This output can be reset by momentarily opening and then closing the fault check input. Please note that the brake monitor system operates independently of the fault check system but both use the fault check input to reset their individual faults. Opening the fault check input will de-energize the fault and brake monitor output relays allowing the user to verify that these outputs are operating properly and have not been hardwired.

NOTE: In efforts to make the brake monitor fail-safe , we have changed the brake monitor circuit so that if you see motion without seeing the brake input, a break fault will occur.

WIRING

Wire the programmer per Fig 11-2 (Chapter 11: Wiring Diagrams). In this drawing, relay LS6 is the brake monitor relay. It is normally energized (N.O. contact is closed and N.C. contact is open) and de-energized on a fault condition. Operating in this manner a disconnected wire or disconnected relay will indicate a fault condition.

Relay LS5 is either a standard LS output or the motion detect output, as selected by the customer. If operating as a motion detect output, the relay will energize when the transducer speed is greater than the customer programmed RPM value.

The brake monitor calculates stopping time by monitoring the time span between the clutch disengagement and the press's coming to a complete stop. The system begins this timing sequence when it sees the isolated contact, wired between input terminals 14 and 15, open. This isolated contact can be the contact of an existing relay in your control circuit or it can be provided by the Gemco's optional Brake Monitor input Relay #SD0395100 as shown on the next page. The contact of the brake monitor input relay must be open when the clutch disengages, and all wiring between its isolated contact and terminals 14 and 15 of the 1995 programmer must be protected from induced electrical noise.

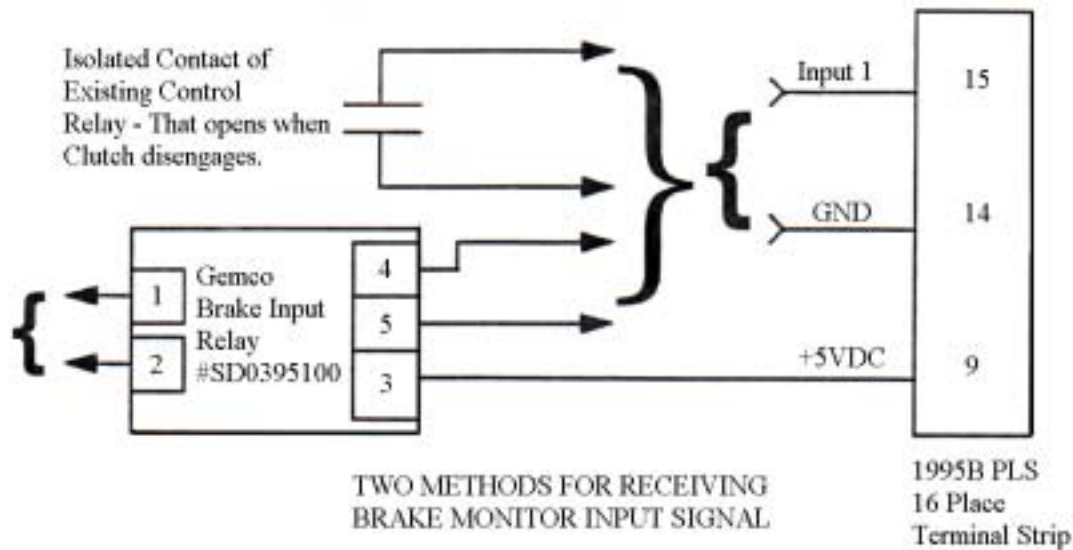

PROGRAMMING AND MONITORING

To monitor press stopping time, depress CIR# - 174 - ENT. Stopping time will be displayed in milliseconds from 001 to 999. Three decimal points indicate a stopping time in milliseconds, a single decimal point, two places to the left, will indicate a stopping time in seconds to one hundredth of a second. If the customer's preset stopping time is exceeded, the display and decimal(s) will flash. They will continue to flash until the brake monitor output has been reset.

To monitor press stopping angle, depress CIR# - 175 - ENT. Stopping distance will be displayed in degree increments. If the stopping time is exceeded while in the stopping angle mode, the display will flash. It will continue to flash until the brake monitor relay has been reset.

When operating in either of the above modes, the display will maintain the stopping data until initiation of the next timing cycle. At this point, the display will indicate dashes until new data is available. Depression of the POS or RPM keys will return the display from this operating mode.

To program the maximum acceptable stopping time, depress CIR# - 173 - ENT. The time data can be programmed from 001 to 999 milliseconds. If the programmed stopping time is exceeded, the brake monitor output (LS6) will de-energize until the fault check input is opened and then closed again.

NOTE: If you are using the fault check option, the fault check relay will cycle OFF/ON when the brake fault output is reset.

Programming the Maximum Stopping Time

- A) Unit must be in the Program mode.
- B) Depress **CIR#** - **1** - **7** - **3** - **ENT** - **Maximum Stopping Time** - **ENT**
 This sets the maximum allowable stopping time in .001 second intervals. If the time required to stop following the loss of the brake monitor contact exceeds the brake monitor stopping time, then the error output LS6 is de-energized.

Display of Stopping Time

- A) Depress **CIR#** - **1** - **7** - **4** - **ENT**. The display will sample and hold the stopping time of each press stroke. The stopping time is displayed in milliseconds. A single decimal in the left-most position will indicate that a stopping time is in seconds. The display will flash when the brake monitor stopping time (CIR# 173) has been exceeded. The display will stop flashing when the error is reset with the fault check input. Exiting this mode is done only by pressing the RPM/POS key. No values may be entered.

Display of Stopping Angle

- A) Depress **CIR#** - **1** - **7** - **3** - **ENT**. The display will sample and hold the number of degrees traveled after initiation of the brake command. The stopping distance is the distance traveled since the loss of the contact. The display will flash when the brake monitor stopping time (CIR# 173) has been exceeded. The display will stop flashing when the error is reset with the fault check input. Exiting this mode is done only by pressing the RPM/POS key. No values may be entered.

Chapter 4: Expansion Modules

The **1995B PLS** provides five outputs. A 1995E Expansion Module is required for each additional six outputs desired, up to a total of 29 outputs, or four expansion modules (units with **Remote Circular Displays** may use only up to 23 outputs total, or three expansion modules). The circuit location of each expansion module is defined by the location of a two-pin jumper on an eight-pin block in the upper left corner of the module. This jumper must be installed for the expansion module to operate. Two pairs of pins, located in the lower right corner of the expansion module, should be jumpered on only the last module in the wiring group. However, if a **Remote Circular Display** is being used, do not install these jumpers. Remove both jumpers from all intermediate expansion modules. See Chapter 11: Wiring Diagrams, Fig. 11-3 for additional expansion module wiring information. Each expansion module is provided with a full set of terminal strip designation decals. To avoid confusion, the appropriate decals should be installed along the output terminals, based on the location of the output selection jumper outlined below.

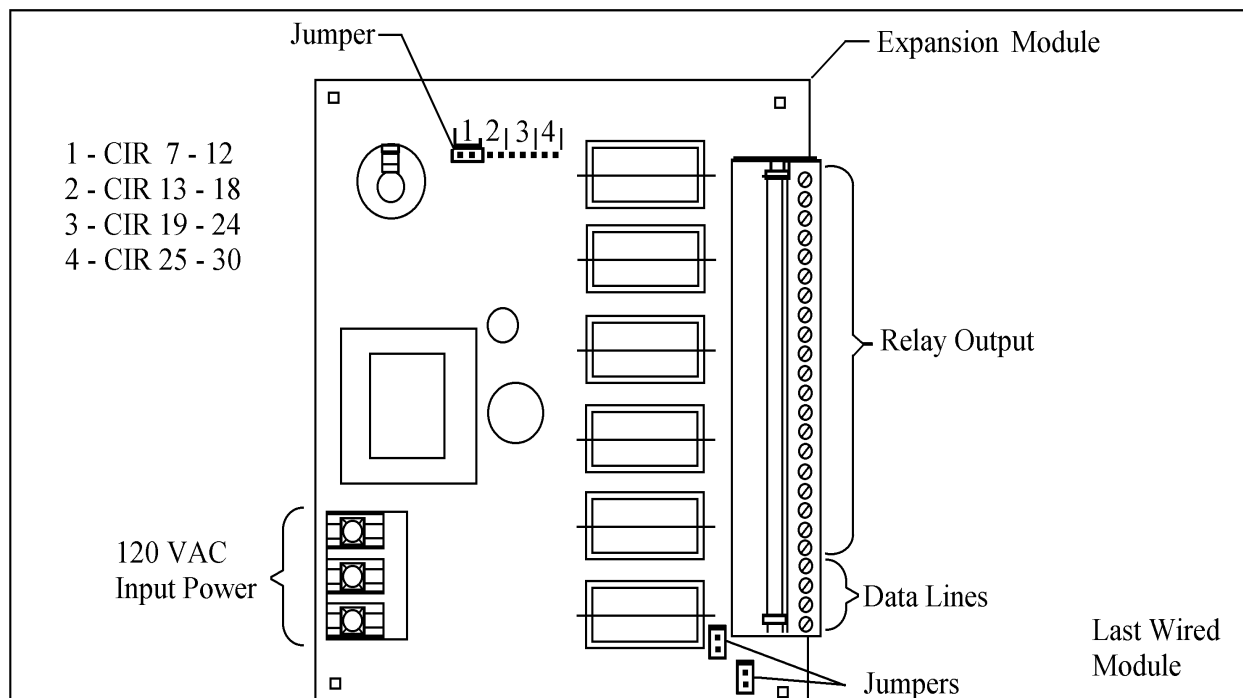

Fig. 4-1

See Section 3.5: Selecting Number of Outputs, for instructions on how to program unit for use with expansion modules.

Chapter 5: Fault Check

The Fault Check option provides an automatic in-process self-diagnostic mechanism to verify that all PLS functions are operating properly.

The Fault Check option will detect and disable system operation in the event of any of the following problems:

1. Disconnect or severed resolver cable.
2. Open or shorted resolver signals.
3. Resolver excitation failure.
4. Resolver-to-digital converter or associated electronic failure.
5. Microprocessor or 5 volt power supply failure.

Non-system-type faults, such as individual output failures, will not be sensed. It is recommended that the Fault Check output be used as an “operate enable” type signal. Loss of this output should immediately stop the process which is being controlled.

The Fault Check input may be operated by an isolated contact, current sourcing, or current sinking device 5V DC at 10mA.

A normally closed, momentary open contact button can be wired per Fig 11-2, Chapter 11: Wiring Diagrams, to activate the Fault Check circuit, and it will provide a method of resetting the fault output after a fault condition has been sensed.

To reset the Fault Check output after the fault condition has been cleared, the fault reset input must be deactivated (open circuit) and then re-actuated. Cycling the fault reset input will cycle the fault check relay to verify that the Fault Check output is operating properly.

NOTE: If the Fault Check inputs are not wired, the display will still show when there is a fault and the outputs will be disabled, but it will not lock on the fault. However, if the fault check inputs are wired as per Fig 11-2, Chapter 11: Wiring Diagrams, then upon seeing a fault, the fault check relay will drop out and all outputs will shut off until the fault is fixed and the fault check input is reset.

5.1: PLS Output Status on Fault Conditions

- 1) If a fault condition is detected, **ALL** limit switch outputs will turn off and the display will show the following:

EE0	=	Resolver Not Plugged in or Resolver Primary Open
EE1	=	Resolver Secondary S1-S3 Open or Shorted
EE2	=	Resolver Secondary S2-S4 Open or Shorted
EE3	=	Resolver Shorted - Primary Winding or Resolver Excitation Fault
EE4	=	Electronic Transducer Tracking Fault
No Message	=	Microprocessor or 5 Volt Power Supply Failure

The message will remain on the display and the outputs will be off until the problem is corrected and the fault reset button is pressed and released to reactivate the fault output and return the display and outputs to their normal operation.

- 2) If the fault condition is the result of a microprocessor failure or lockup, the state of the limit switch output circuits cannot be predicted. However, the fault check output will turn off until the fault is cleared and the fault reset button is pressed and released. Removal and reapplication of power to the PLS system may clear a locked-up condition.

Chapter 6: Security Inputs

The Run/Program security inputs may be operated by an isolated contact, current sourcing, or a current sinking device, 5V DC @ 10mA. See Fig 11-2, Chapter 11: Wiring Diagrams.

NOTE: The **1995 PLS** cannot be programmed until the security input has been enabled by means of connections from Pin 9 (+5V DC) to Pin 10 (Security +) input and from Pin 11 (Security -) input to Pin 14 (GND).

NOTE: If the Run/Security program is not needed (always in the Program mode) install jumper wires from Pin 9 (+5V DC) to Pin 10 (Security +) and from Pin 11 (Security -) to Pin 14 (GND) on the 16-place resolver connector.

Chapter 7: Remote Circular Display

The **Remote Circular Display** (1995-1446) is ideal for mechanical stamping presses and shears. Either position or RPM can be displayed on the large 3/4" LED digital display. A 360° bar graph will increment in 10° intervals showing the angle of the resolver.

The remote circular display gets its RS422 synchronous signal from the four-place terminal strip located on the back of the 1995 programmer. The display can be located up to 1,000 feet away from the programmer. See Fig 11-3, Chapter 11: Wiring Diagrams.

Installation and wiring of the remote circular display should be followed in the same manner as the **1995B** described earlier in Chapter 2: Installation.

NOTE: When using a remote circular display, the maximum number of outputs is limited to 23 outputs or three expansion boards.

7.1: POS/RPM On Remote Circular Display

The 3/4" LED display can display either position or RPM while the bar graph will always show angular position. To display RPM install a jumper wire from Pin 6 (RPM) to Pin 7 (GND) on the 11-place connector located on the bottom of the remote circular display.

Chapter 8: Troubleshooting

The following procedures are intended to aid in isolating system malfunctions to field replaceable modules. These modules include the 1995 programmer, output relays, remote circular display, transducer, and all interconnecting cables. Once isolated, the defective module should be replaced and returned to the factory for repair.

NOTE: Field repair beyond this level is not recommended.

8.1: Preliminary Checks

Check all system wiring connections at the transducer and at the programmer. Amphenol-type connectors on the transducer and its cabling should be checked for tightness. A slight tug on all wire terminations should verify a good connection. Push-on cable connectors should be checked for proper connections. Verify that incoming AC voltage to the **1995 PLS** is between 105V AC and 125V AC.

8.2: Transducer Excitation Voltages

AC voltage across terminals 2 (RH) and 3 (RL) of the 16-place terminal strip (labeled Red and BK/R) should be from 1.6 to 1.9V RMS. This is the output voltage being supplied to the resolver rotor. If this voltage is not present, disconnect the resolver wires at the 1995 programmer and recheck the voltage. If this voltage is still not present, the resolver excitation circuitry in the 1995 programmer has failed and should be replaced. If this voltage appears, a shorted condition in the resolver or its cable should be checked.

The return signals from the resolver stator windings are wired to the 1995 programmer's 16-place terminal strip at terminals 4 and 5 (labeled White and BK/W), and terminals 6 and 7 (labeled Green and BK/G). To verify the presence of these AC return signals, put a voltmeter across terminals 4 and 5 and rotate the resolver. A voltage reading that rises and falls (0-2.3V RMS) between these terminals as the resolver is rotated indicates a good resolver return signal. Repeat this same procedure with your meter across terminals 6 and 7. No voltage or a voltage that does not vary as the resolver rotates indicates an open or shorted condition in the resolver windings or the resolver cable.

To check for an open or shorted condition inside of the resolver, disconnect the Amphenol-style connector from the transducer and make the following checks at the resolver: Measure the resistance across Pins A & B (rotor); it should measure approximately 19-50 ohms. Then measure across Pins C & D (stator); it should measure approximately 50-120 ohms. The resistance across E & F should be the same as C & D.

NOTE: Due to the many different types of resolvers that we have used over the years, these resistance readings are only approximate and are intended for locating opens or shorts in the resolver wires or windings.

8.3: Electrical Noise and Power Quality Consideration

The **1995 PLS** is designed for use in an industrial environment and incorporates extensive transient suppression circuitry. However, the same general installation rules should be followed that apply to all microprocessor-based equipment.

Problems that can be attributed to extreme electrical noise or poor power quality include loss of/or changes in program memory, loss of initialization, keypad or microprocessor lockup, sporadic outputs, and damage to resolver drive circuits and auxiliary input circuits.

8.4: Grounding

Circuit board level noise suppression circuits, ground planes, and cable shields all depend on a good earth ground for proper operation. Our field experience has shown that the quality of the service ground at many machines is marginal.

8.5: Incoming Power

Solenoids, welders, large motors, and variable-speed drives are all devices that generate excessive electrical noise throughout the power grid in a typical industrial environment. Isolation transformers or constant voltage type power supplies should be used to isolate microprocessor-based circuitry. The power on the output side of these isolation devices should be fed to the programmable limit switch and other microprocessor-based devices only. The loads being driven by the programmable limit switch output relays *must not* get their power from the output side of the isolation device. Using the output side of an isolation device to power loads other than the programmable limit switch totally defeats the purpose of the isolation device.

NOTE: When using an output relay for driving inductive loads such as solenoids, a noise suppression device *must* be installed across the coil of the load. Use an MOV or RC noise suppressor for AC loads, or a commutating diode for DC loads.

8.6: Low Level Inputs

Low level inputs to the **1995B PLS** include the resolver cable and other special purpose contacts such as fault check, brake monitor and security inputs.

The resolver should be wired to the **1995 PLS** using an uninterrupted run of cable consisting of four twisted pairs with shields. Whenever possible, this cable should be run in a conduit by itself. If it must run in a conduit with other wiring, this wiring should not include power wires above 110V AC or wires driving noise producing loads.

If the resolver cable must be run through a terminal strip, it must be mounted in a small enclosure with no other wiring. The shields of the incoming and outgoing cable must be tied together and isolated from ground.

Special purpose contact inputs all operate by connecting the input pin on the **1995 PLS** to a power or GND terminal (depending on method wired per Fig. 11-2; Chapter 11: Wiring Diagrams) on the **1995 PLS** through a remote contact or solid-state switch. These computer level signals must be protected from induced electrical noise.

The contact used to activate the input should not be located outside the enclosure in which the **1995 PLS** is mounted. Any wiring between the **1995 PLS** input terminals and this contact located within the enclosure should be routed away from any power handling relays, contactors, or other noise generating devices.

If the input is to be activated by a remote device, the contact of the remote device should be used to energize a relay within the enclosure. The contacts of this relay are wired to the **1995 PLS** input terminals.

Chapter 9: Specifications

9.1: 1995 Micro-Set PLS Programmer

Resolution	-12 Bit (4096)
Scale Factor	-360
Scan Time	-Standard 335 μ seconds
Temperature	-32°F to 125°F (Operating)
Range	-0°F to 150°F (Storage)
Operating Voltage	-110/120V AC 50/60 Hz 300 mA

INPUTS

Transducer	-Resolver accurate to ± 3 arc minutes provides resolution of 1 part in 4096, 2800 RPM maximum speed.
Logic	-Fault check and security 5V DC at 10mA. May be operated by isolated contact, current sourcing or current sinking device.

OUTPUTS

-Plug-in relays listed below

9.2: Mechanical Relay (Single Pole, Double Throw)

Contact Relay	-10 Amp Isolated Contact
Pick-Up	-2 ms
Drop-Out	-15 ms

9.3: AC Solid-State (Single Pole, Normally Open)

Maximum Load	-1 Amp
Load Voltage Range	-70 - 250V AC Zero Voltage Switching
Leading Current	-3 mA at 120V AC
Voltage Drop w/Output On	-3.0V RMS or Less
Inputs	-N.O. and Common
Operate & Reset Time	-1/2 cycle of line voltage max. +1ms or less

9.4: DC Solid-State (Single Pole, Normally Open)

Maximum Load	-2 Amp DC
Load Voltage Range	-5 to 60V DC
Leakage Current	-2 mA Maximum
“On” State Voltage Drop	-1.5V Maximum
Surge Current	-5A (1 Sec. Maximum)
Min. Operational Current	-50 mA
Operate Time	-0.5ms Maximum
Reset Time	-2 ms Maximum

9.5: 1995E Output Expansion Module

Operating Voltage	-110/120V AC 50/60 Hz 100 mA
Temperature Range	-32°F to 125°F (Operating) 0°F to 150°F (Storage)
Outputs	-Same as Programmer

9.6: 1995-1446 Remote Circular Display

Operating Voltage	-110/120V AC 50/60 Hz 150 mA
Temperature Range	-32°F to 125°F (Operating) 0°F to 150°F (Storage)

Chapter 10: Troubleshooting Guide

SYMPTOM	POSSIBLE CAUSES
Display Shows: EEE	Incorrect programming sequence or unit is not in the program mode. Review Chapter 6: Security Inputs for Run/Program information.
Display Shows: EE0 EE1 EE2 EE3 EE4	Unit has detected a fault. Review Chapters 5: Fault Check and 8: Troubleshooting.
Display Shows: PPP	Loss of initialization. Loss of initialization indicates a severe power fluctuation or electrical noise. Review Chapter 8: Troubleshooting and Section 3.2: Initialization.
An individual output relay does not operate, but status light on keypad indicates proper operation.	Output relay failure. If relay status LED on keypad operates, but the relay doesn't turn on, relay may have failed. Replace relay.
Keypad displays meaningless data.	System mounted in a high shock or vibration area causing intermittent electrical connections. System operating in a high electrical noise environment. Review installation instructions concerning routing of cables in Section 8.6: Low Level Inputs and also review general electrical noise considerations in Section 8.3: Electrical Noise and Power Quality Consideration.
Unit displays EEE when offset button is depressed.	Either unit is not in the program mode, or your unit is equipped with a special access code where only authorized personnel can offset system. Refer to Supplemental Software instructions.

SYMPTOM	POSSIBLE CAUSES
System operates properly but exhibits a random momentary loss of all outputs.	Random momentary loss of all power to the system. A loss of power for as short a duration as 50 milliseconds will cause the system to shut down. When power is reapplied, the system can take several seconds to reinitialize itself. During this time period, all outputs are disabled. This intermittent loss of power could be caused by a bad terminal strip connection, bad relay contact, application of a very large motor load, or momentary loss of incoming plant power.
The display and outputs lose synchronization with machine position.	A gradual, recurring loss of synchronization is generally caused by slippage in the mechanical couplings to the resolver. Verify the mechanical integrity of couplings, sprockets, chains, and so forth, that are in the drive train to the resolver's input shaft. The resolver assembly uses a small, internal flexible coupling to connect its input shaft to the resolver; this is mounted inside the assembly. Disassemble the resolver and check the tightness of the coupling screws.
Flashing decimal points when programming a circuit.	Flashing decimal points indicates multiple setpoints on the selected circuit. To see all settings, continue depressing the "CIR ON" or "CIR OFF" key until all setpoints have been displayed. See Section 3.8: Setpoints.
LS5 cannot be programmed	LS5 is probably set up for a motion detect circuit. See Section 3.13: Motion Detector for details.
Linear Speed outputs are not operating.	The minimum speed enable RPM has not been reached. See Section 3.19: Minimum Speed Disable for details.
Linear Speed outputs will not offset.	Review what is stored in CIR# 501, 502, 503, etc. If a 0 is stored in the circuit off, all steps after that are cleared. See Section 3.17: Linear Speed Offset. Review which circuits are enabled for Linear Speed.

SYMPTOM	POSSIBLE CAUSES
Brake Monitor Fault	<p>The maximum allowable stopping time has been exceeded (CIR # 173). Review Section 3.21: Brake Monitor Operational Description.</p> <p>If the brake fault output trips and the maximum allowable stopping time has not been exceeded, either the Micro-Set detected 5 RPM of movement without sensing the brake input, or the brake input relay module (SD0395100) has failed. Refer to Section 3.21: Brake Monitor Operational Description.</p>
Fault check relay not enabled.	<p>The fault check relay will only be enabled when the fault check input is wired per Fig. 11-2 (Chapter 11: Wiring Diagrams). If a fault is detected without the input wired, the display will show the fault message and all outputs will be disabled until the fault is fixed.</p> <p>If the fault check input is wired per Fig. 11-2 (Chapter 11: Wiring Diagrams) and a fault is detected, the display will show an ERROR MESSAGE. All outputs will be disabled and the fault check OK relay will drop out and remain dropped out until the fault is fixed and the fault check input is reset. See Chapter 5: Fault Check for details.</p>
Unit will momentarily display a fault error message.	The system is detecting a momentary fault, but will not lock on it because the fault check input is not wired per Fig. 11-2, (Chapter 11: Wiring Diagrams).
Unit is counting in the wrong direction.	On the resolver cable, reverse Black-Green wire pair. Refer to Fig. 11-2, (Chapter 11: Wiring Diagrams).

Chapter 11: Wiring Diagrams

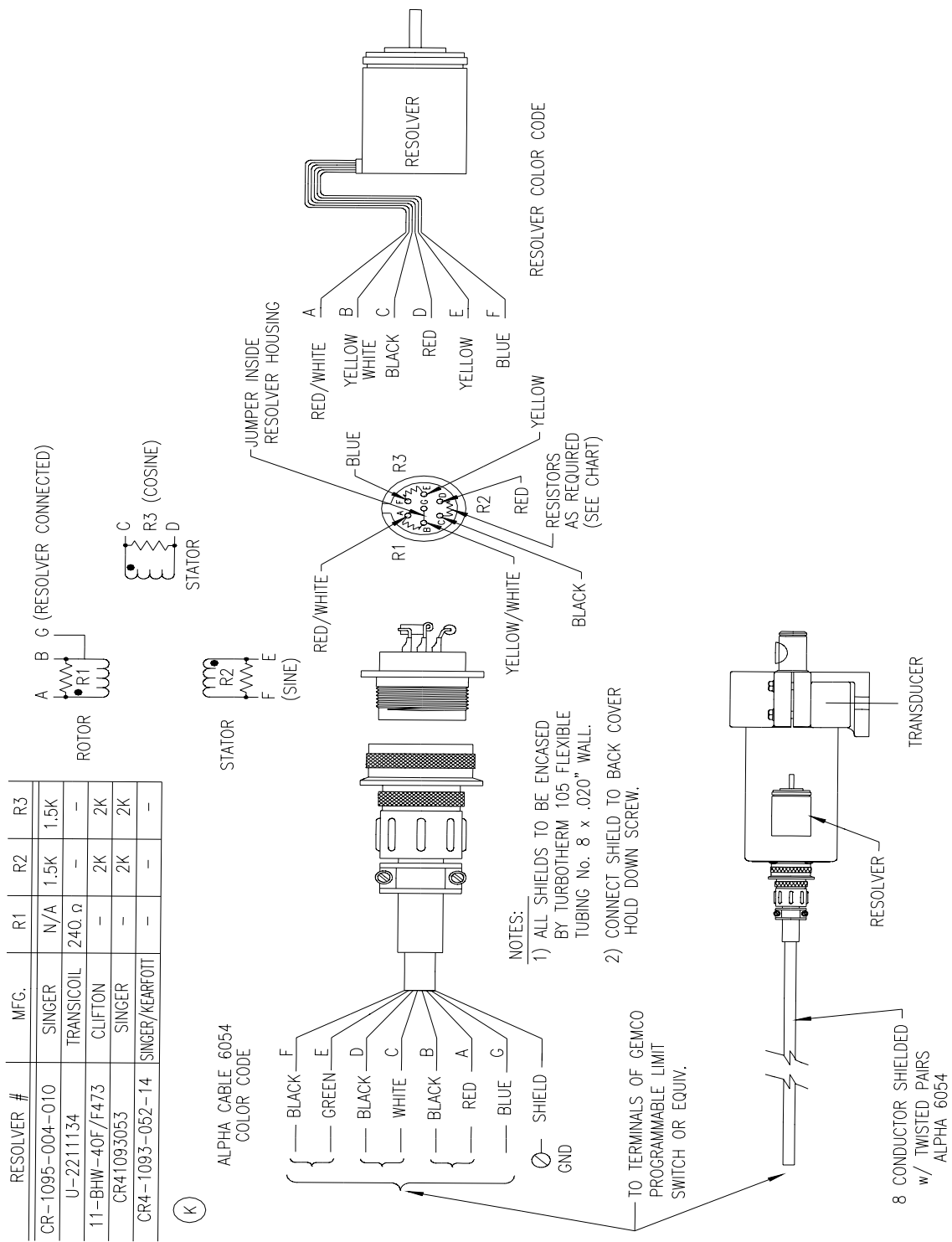

Fig 11-1 Wiring Diagram
Drawing E0177100

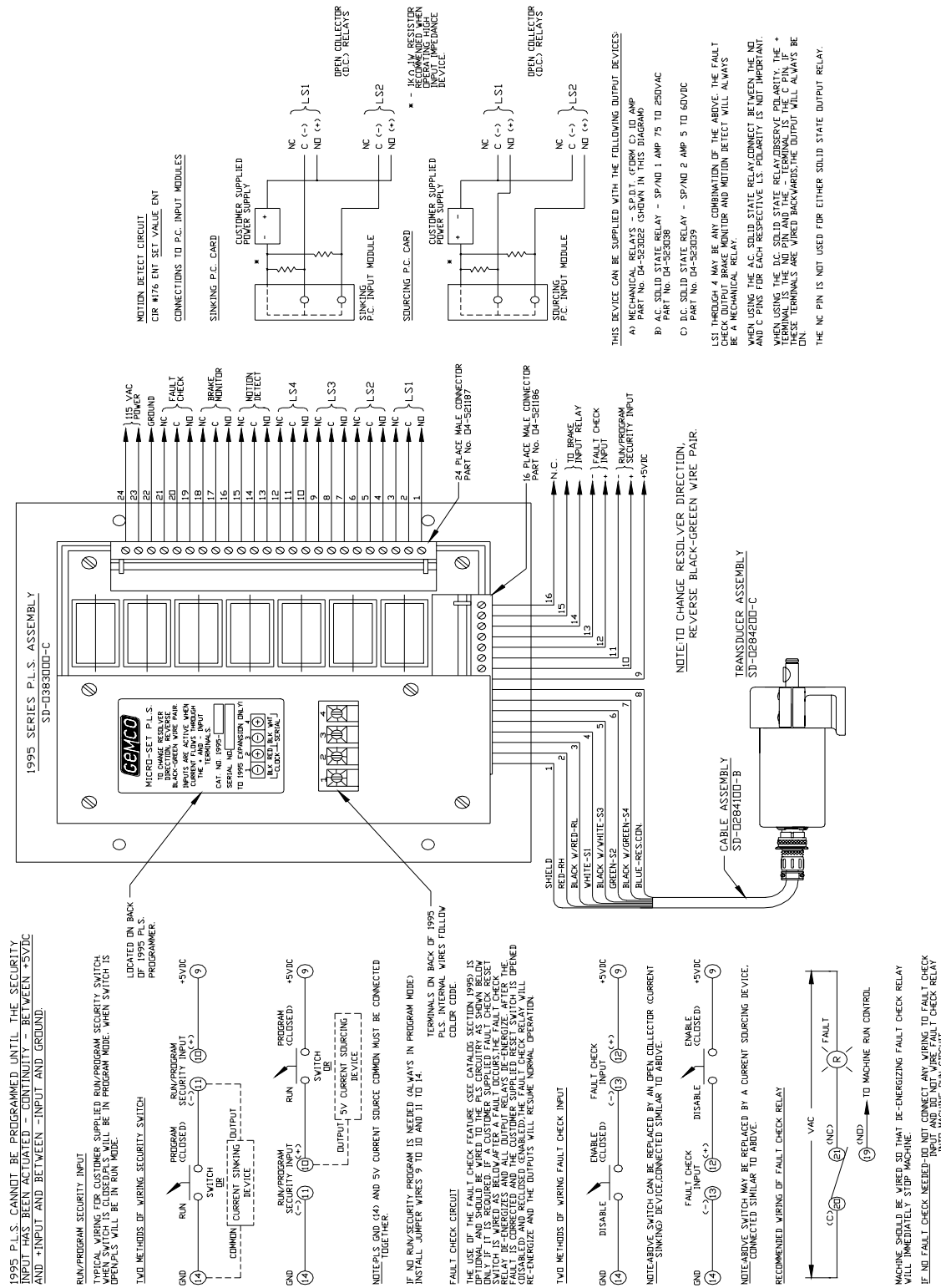

Fig 11-2 Wiring Diagram Drawing E0198203

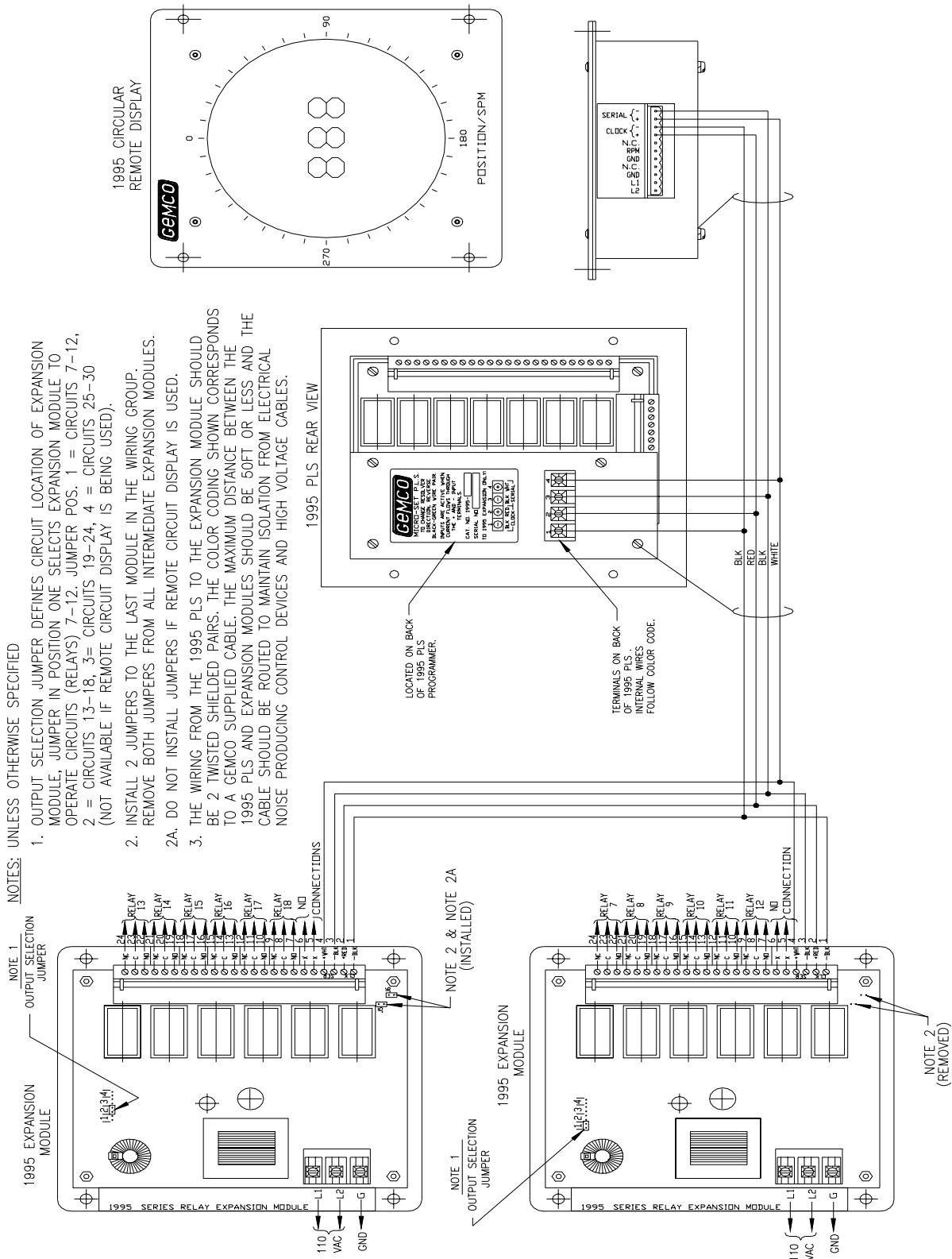

Fig 11-3 Wiring Diagram
Drawing E0204400

GEMCO

AMETEK[®]
AUTOMATION & PROCESS TECHNOLOGIES

1080 N. Crooks Road • Clawson, MI 48017
800-635-0289 • 248-435-0700 • Fax 248-435-8120
www.ametekapt.com • www.ametek.com

898 01/03.Z83 5C
