

Three-Light Unit Stacklight  
with 60 mm Extension



## 2.1 E26 Series

Product Description .....	V7-T2-2
Features .....	V7-T2-2
Benefits .....	V7-T2-2
Standards and Certifications.....	V7-T2-2
Product Identification .....	V7-T2-3
Catalog Number Selection .....	V7-T2-4
Product Selection .....	V7-T2-5
Replacement Parts .....	V7-T2-10
Technical Data and Specifications.....	V7-T2-11
Ratings .....	V7-T2-12
Mounting Instructions.....	V7-T2-13
Dimensions.....	V7-T2-14

Stacklights—E26 Series

2



### Product Description

The E26 stacklight unit is a modular system that provides illuminated and audible status indication in all directions. Easily assembled plug-in modular units include constant, flashing and strobe light units, as well as mono-tonal, bi-tonal, intermittent audible alarms. Stacklights may be assembled in a variety of configurations, which are identified in the Maximum Configurations table on **Page V7-T2-3**. Several lamp, color and mounting options further enhance the stacklight's versatility.

### Features

- Modular construction
- Six lens colors
- Variety of lamp types and voltages
- Mono-tonal, bi-tonal and intermittent audible alarms

### Benefits

- Combination of visible and audible alarms
- Modular components reduce inventory requirements, increase flexibility
- Steady and flashing modes allow one light to signal multiple conditions
- No-tools assembly permits easy lamp replacement

### Standards and Certifications

- CE 60947-5-1
- UL 508—File No. E131568
- cUL C22.2 No. 14—File No. E131568



### Ingress Protection

- Stacklight base and light units: IP65, NEMA 4, 4X and 13
- Alarm units: IP20, NEMA 1

### Electrical Shock Protection

- Stacklight base and light unit: IP2X
- Alarm units: IPOX

### Contents

<b>Description</b>	<b>Page</b>
E26 Series	
Product Identification . . . . .	<b>V7-T2-3</b>
Catalog Number Selection . . . . .	<b>V7-T2-4</b>
Product Selection . . . . .	<b>V7-T2-5</b>
Replacement Parts . . . . .	<b>V7-T2-10</b>
Technical Data and Specifications . . . . .	<b>V7-T2-11</b>
Ratings . . . . .	<b>V7-T2-12</b>
Mounting Instructions . . . . .	<b>V7-T2-13</b>
Dimensions . . . . .	<b>V7-T2-14</b>

## Product Identification



### Standard Stacklight Base

For use with incandescent or standard LEDs for steady, non-flashing illumination or with flashing LEDs for flashing illumination. Bases include terminal block for wiring, stacklight cover and gasket. See **Page V7-T2-8**.



### Flashing Stacklight Base

Allows configuration of each light in the stack for either steady or 60 times per minute flashing illumination. Flashing circuit for use with incandescent lamps only. (Maximum allowable number of light modules is 2 at 12V, 4 at 24V and 6 at 48V and above.) See **Page V7-T2-8**.

For flashing LEDs use standard base with flashing LED light module.



### Light Modules

Available in a variety of colors for both incandescent lamps and LED lamps. To maximize illumination and light dispersion, incandescent units include an opal white diffuser while LED diffusers are clear. See **Page V7-T2-6**.



### Xenon Strobe

Sets are similar to standard lens/diffuser units, except each set consists of two lens units. The lower unit includes the electronics and is permanently fused to the upper unit which contains the Xenon lamp. Xenon units may be placed in any position in a complete stacklight unit. They will flash 60 times per minute when used with a standard or flashing base. See **Page V7-T2-6**.



### Alarms

May be fitted to the top of a complete stacklight unit or directly to the stacklight bases, if desired. Available in three versions, each with adjustable sound levels. See **Page V7-T2-9**.

## Complete Stacklight Modules



- Stacklights accept a maximum of six incandescent or LED light modules or two Xenon Flasher modules and can be mounted in any position on the stack.
- Alarm units are mounted in the top most position only.

## Maximum Configurations

Incandescent or LED Modules	Xenon Modules	Alarm Modules	Max. Number of Modules
6	—	—	6
5	—	1	6
4	1	—	5
3	1	1	5
2	2	—	4
1	2	1	4

### Catalog Number Selection

#### Stacklight Catalog Numbering System

2

**E26X 9 KM L 39R W - V 4**

Mounting Base <sup>①</sup>		
Code	Description	Component Catalog No.
<b>W</b>	None (base mount)	—
<b>4</b>	3/4 in NPT hub, chrome	E26S104
<b>8</b>	Standard three-hole	E26S108
<b>9</b>	Standard four-hole	E26S109

Extension Tube <sup>⑤</sup>		
Code	Description	Component Catalog No.
<b>W</b>	None (base mount)	—
Gray Aluminum		
<b>HM</b>	20 mm 3/4 in NPT	E26BHM
<b>JM</b>	160 mm 3/4 in NPT	E26BJM
<b>KM</b>	360 mm 3/4 in NPT	E26BKM
<b>MM</b>	760 mm 3/4 in NPT	E26BMM
Black Aluminum		
<b>HU</b>	20 mm 3/4 in NPT	E26BHU
<b>JU</b>	160 mm 3/4 in NPT	E26BJU
<b>KU</b>	360 mm 3/4 in NPT	E26BKU
<b>MU</b>	760 mm 3/4 in NPT	E26BMU
<b>RU</b>	Right angle 3/4 in NPT	E26BRU

Stacklight Base		
Code	Description	Component Catalog No. <sup>②</sup>
<b>L</b>	Standard	E26BL
<b>F</b>	Flashing <sup>⑥</sup>	E26BF_

Alarm		
Code	Description	Component Catalog No. <sup>②</sup>
<b>W</b>	None	—
<b>Q</b>	Mono-tonal	E26BQ_
<b>N</b>	Bi-tonal	E26BN_
<b>P</b>	Intermittent	E26BP_

Voltage <sup>③</sup>	
Code	Description
<b>V1</b>	12V
<b>V2</b>	24V
<b>V3</b>	48V
<b>V4</b>	120V
<b>V5</b> <sup>④</sup>	240V

Light Module		
Code	Description	Component Catalog No. <sup>②</sup>
<b>0</b>	Clear incandescent	E26B0_
<b>2</b>	Red incandescent	E26B2_
<b>3</b>	Green incandescent	E26B3_
<b>4</b>	Yellow incandescent	E26B4_
<b>6</b>	Blue incandescent	E26B6_
<b>9</b>	Amber incandescent	E26B9_
<b>W</b>	White cluster LED with clear lens	E26BW_
<b>R</b>	Red cluster LED with red lens	E26BR_
<b>G</b>	Green cluster LED with green lens	E26BG_
<b>Y</b>	Yellow cluster LED with yellow lens	E26BY_
<b>B</b>	Blue cluster LED with blue lens	E26BB_
<b>A</b>	Amber cluster LED with amber lens	E26BA_
<b>W1</b>	White cylindrical LED with clear lens <sup>④</sup>	E26BW1_
<b>R1</b>	Red cylindrical LED with red lens <sup>④</sup>	E26BR1_
<b>G1</b>	Green cylindrical LED with green lens <sup>④</sup>	E26BG1_
<b>Y1</b>	Yellow cylindrical LED with yellow lens <sup>④</sup>	E26BY1_
<b>B1</b>	Blue cylindrical LED with blue lens <sup>④</sup>	E26BB1_
<b>A1</b>	Amber cylindrical LED with amber lens <sup>④</sup>	E26BA1_
<b>M</b>	Flashing white cluster LED with clear lens	E26BM_
<b>E</b>	Flashing red cluster LED with red lens	E26BE_
<b>U</b>	Flashing green cluster LED with green lens	E26BU_
<b>V</b>	Flashing yellow cluster LED with yellow lens	E26BV_
<b>K</b>	Flashing blue cluster LED with blue lens	E26BK_
<b>Z</b>	Flashing amber cluster LED with amber lens	E26BZ_
<b>X0</b>	Xenon flasher with clear lens	E26BX0_
<b>X2</b>	Xenon flasher with red lens	E26BX2_
<b>X3</b>	Xenon flasher with green lens	E26BX3_
<b>X4</b>	Xenon flasher with yellow lens	E26BX4_
<b>X6</b>	Xenon flasher with blue lens	E26BX6_
<b>X9</b>	Xenon flasher with amber lens	E26BX9_

#### Voltage Codes

Voltage Code	Incandescent Lamp	Cluster LED	Cylindrical LED	Xenon Flasher	Flasher Base/Alarm
(Blank)	No lamp supplied	No LED supplied	No LED supplied	—	—
<b>V1</b>	12 Vac/Vdc	12 Vac/Vdc	12 Vac/Vdc	12 Vac/Vdc	12 Vac/Vdc
<b>V2</b>	24 Vac/Vdc	24 Vac/Vdc	24 Vac/Vdc	24 Vac/Vdc	24 Vac/Vdc
<b>V3</b>	48 Vac/Vdc	48 Vac/Vdc	48 Vac/Vdc	48 Vac/Vdc	48 Vac/Vdc
<b>V4</b>	120 Vac/Vdc	120 Vac	120 Vac	120 Vac	120 Vac/Vdc
<b>V5</b>	240 Vac/Vdc	240 Vac	—	240 Vac	240 Vac/Vdc

#### Notes

- ① Unless base mount is specified, an extension tube must be selected for a complete unit.
- ② Component catalog numbers for flashing bases, alarm units and light modules are incomplete and require the addition of a suffix code to specify the required voltage rating. See table above.
- ③ If no voltage is specified, assembled stacklight will be supplied without lamps or LEDs.
- ④ 240V not available for cylindrical LEDs.
- ⑤ For complete length (extension tube and base), see **Page V7-T2-9**.
- ⑥ Flashing base is for use with incandescent lamps.

## Product Selection

### Assembled Units

#### One-, Two- and Three-Light Assembled Stacklights

- Base mountable
- Incandescent or LED versions
- 24V and 120V versions

#### One-Light Unit Stacklight

Volts AC/DC	Alarm	First Level Color	Illumination Type	Catalog Number
24V	None	Red	Incandescent—steady	<b>E26XWWL2W-V2</b>
24V	None	Red	Cylindrical LED—steady	<b>E26XWWLR1W-V2</b>
24V	None	Green	Incandescent—steady	<b>E26XWWL3W-V2</b>
24V	None	Green	Cylindrical LED—steady	<b>E26XWWLG1W-V2</b>
24V	None	Amber	Incandescent—steady	<b>E26XWWL9W-V2</b>
24V	None	Amber	Cylindrical LED—steady	<b>E26XWWLA1W-V2</b>
120V	None	Red	Incandescent—steady	<b>E26XWWL2W-V4</b>
120V <sup>①</sup>	None	Red	Cylindrical LED—steady	<b>E26XWWLR1W-V4</b>
120V	None	Green	Incandescent—steady	<b>E26XWWL3W-V4</b>
120V <sup>①</sup>	None	Green	Cylindrical LED—steady	<b>E26XWWLG1W-V4</b>
120V	None	Amber	Incandescent—steady	<b>E26XWWL9W-V4</b>
120V <sup>①</sup>	None	Amber	Cylindrical LED—steady	<b>E26XWWLA1W-V4</b>

#### Two-Light Unit Stacklight

Volts AC/DC	Alarm	First Level Color	Illumination Type	Second Level Color	Illumination Type	Catalog Number
24V	None	Green	Incandescent—steady	Red	Incandescent—steady	<b>E26XWWL32W-V2</b>
24V	None	Green	Cylindrical LED—steady	Red	Cylindrical LED—steady	<b>E26XWWLG1A1R1W-V2</b>
120V	None	Green	Incandescent—steady	Red	Incandescent—steady	<b>E26XWWL32W-V4</b>
120V <sup>①</sup>	None	Green	Cylindrical LED—steady	Red	Cylindrical LED—steady	<b>E26XWWLG1A1R1W-V4</b>

#### Three-Light Unit Stacklight

Volts AC/DC	Alarm	First Level Color	Illumination Type	Second Level Color	Illumination Type	Third Level Color	Illumination Type	Catalog Number
24V	None	Green	Incandescent—steady	Amber	Incandescent—steady	Red	Incandescent—steady	<b>E26XWWL392W-V2</b>
24V	None	Green	Cylindrical LED—steady	Amber	Cylindrical LED—steady	Red	Cylindrical LED—steady	<b>E26XWWLG1A1R1W-V2</b>
120V	None	Green	Incandescent—steady	Amber	Incandescent—steady	Red	Incandescent—steady	<b>E26XWWL392W-V4</b>
120V <sup>①</sup>	None	Green	Cylindrical LED—steady	Amber	Cylindrical LED—steady	Red	Cylindrical LED—steady	<b>E26XWWLG1A1R1W-V4</b>

#### Note

- <sup>①</sup> LED modules have very low current draw and should not be used with triac output devices like PLC triac output modules. It is recommended that dry contact outputs be used to switch 120 Vac modules.

# 2.1

## Stacklights

### E26 Series

2

#### Light and Xenon Strobe Modules

- Light modules include lens diffusers which provide even illumination and eliminate hot spots.
- Xenon strobes emit a bright attention-getting white flashing light. Flash rate = 60/min.
- Xenon strobe modules occupy two positions in the stacklight assembly.

#### Light/LED Module



#### Xenon Strobe Module



#### Light and Xenon Strobe Modules <sup>①</sup>

LED/Lamp Voltage	Lens Color	Incandescent Steady or Flashing Catalog Number	Cylindrical LED Steady Only Catalog Number	Cluster LED Steady Catalog Number	Cluster LED Flashing Catalog Number	Xenon Flashing Catalog Number
Without bulb or LED	Red	E26B2	E26B	E26BR	E26BR	—
	Green	E26B3	E26BG	E26BG	E26BG	—
	Yellow	E26B4	E26BY	E26BY	E26BY	—
	Blue	E26B6	E26BB	E26BB	E26BB	—
	Amber	E26B9	E26BA	E26BA	E26BA	—
	Clear	E26B0	E26BW	E26BW	E26BW	—
12 Vac/Vdc	Red	E26B2V1	E26BR1V1	E26BRV1	E26BEV1	E26BX2V1
	Green	E26B3V1	E26BG1V1	E26BGV1	E26BUV1	E26BX3V1
	Yellow	E26B4V1	E26BY1V1	E26BYV1	E26BVV1	E26BX4V1
	Blue	E26B6V1	E26BB1V1	E26BBV1	E26BKV1	E26BX6V1
	Amber	E26B9V1	E26BA1V1	E26BAV1	E26BZV1	E26BX9V1
	Clear	E26B0V1	E26BW1V1	E26BWW1	E26BMV1	E26BX0V1
24 Vac/Vdc	Red	E26B2V2	E26BR1V2	E26BRV2	E26BEV2	E26BX2V2
	Green	E26B3V2	E26BG1V2	E26BGV2	E26BUV2	E26BX3V2
	Yellow	E26B4V2	E26BY1V2	E26BYV2	E26BVV2	E26BX4V2
	Blue	E26B6V2	E26BB1V2	E26BBV2	E26BKV2	E26BX6V2
	Amber	E26B9V2	E26BA1V2	E26BAV2	E26BZV2	E26BX9V2
	Clear	E26B0V2	E26BW1V2	E26BWW2	E26BMV2	E26BX0V2
48 Vac/Vdc	Red	E26B2V3	E26BR1V3	E26BRV3	E26BEV3	E26BX2V3
	Green	E26B3V3	E26BG1V3	E26BGV3	E26BUV3	E26BX3V3
	Yellow	E26B4V3	E26BY1V3	E26BYV3	E26BVV3	E26BX4V3
	Blue	E26B6V3	E26BB1V3	E26BBV3	E26BKV3	E26BX6V3
	Amber	E26B9V3	E26BA1V3	E26BAV3	E26BZV3	E26BX9V3
	Clear	E26B0V3	E26BW1V3	E26BWW3	E26BMV3	E26BX0V3
120 Vac <sup>②</sup>	Red	E26B2V4	E26BR1V4	E26BRV4	E26BEV4	E26BX2V4
	Green	E26B3V4	E26BG1V4	E26BGV4	E26BUV4	E26BX3V4
	Yellow	E26B4V4	E26BY1V4	E26BYV4	E26BVV4	E26BX4V4
	Blue	E26B6V4	E26BB1V4	E26BBV4	E26BKV4	E26BX6V4
	Amber	E26B9V4	E26BA1V4	E26BAV4	E26BZV4	E26BX9V4
	Clear	E26B0V4	E26BW1V4	E26BWW4	E26BMV4	E26BX0V4
240 Vac <sup>②</sup>	Red	E26B2V5	—	E26BRV5	E26BEV5	E26BX2V5
	Green	E26B3V5	—	E26BGV5	E26BUV5	E26BX3V5
	Yellow	E26B4V5	—	E26BYV5	E26BVV5	E26BX4V5
	Blue	E26B6V5	—	E26BBV5	E26BKV5	E26BX6V5
	Amber	E26B9V5	—	E26BAV5	E26BZV5	E26BX9V5
	Clear	E26B0V5	—	E26BWW5	E26BMV5	E26BX0V5

#### Notes

- ① Include lens, diffusers and lamps unless otherwise noted.
- ② Incandescent bulbs are AC/DC rated, LEDs are AC rated only.

## LEDs—Cylindrical or Cluster

Cylindrical  
Stacklight LED

## Cylindrical or Cluster LEDs

## Cluster LED



Voltage	Color	Cylindrical LED Steady Only Catalog Number	Cluster LED Steady Catalog Number	Cluster LED Flashing Catalog Number
12 Vac/Vdc	Red	E26S110	E26S15	E26S48
	Green	E26S114	E26S19	E26S53
	Yellow	E26S112	E26S23	E26S58
	Blue	E26S115	E26S27	E26S63
	White	E26S116	E26S71	E26S75
	Amber	E26S111	E26S79	E26S84
24 Vac/Vdc	Red	E26S117	E26S16	E26S49
	Green	E26S121	E26S20	E26S54
	Yellow	E26S119	E26S24	E26S59
	Blue	E26S122	E26S28	E26S64
	White	E26S123	E26S72	E26S76
	Amber	E26S118	E26S80	E26S85
48 Vac/Vdc	Red	E26S124	E26S17	E26S50
	Green	E26S128	E26S21	E26S55
	Yellow	E26S126	E26S25	E26S60
	Blue	E26S129	E26S29	E26S65
	White	E26S130	E26S73	E26S77
	Amber	E26S125	E26S81	E26S86
120 Vac/Vdc	Red	E26S138	E26S18	E26S51
	Green	E26S142	E26S22	E26S56
	Yellow	E26S140	E26S26	E26S61
	Blue	E26S143	E26S30	E26S66
	White	—	E26S74	E26S78
	Amber	E26S139	E26S82	E26S87
240 Vac/Vdc	Red	—	E26S44	E26S52
	Green	—	E26S45	E26S57
	Yellow	—	E26S46	E26S62
	Blue	—	E26S47	E26S67
	White	—	E26S101	E26S102
	Amber	—	E26S83	E26S88

# 2.1

## Stacklights

### E26 Series

2

#### Mounting Bases Components

##### Standard Base

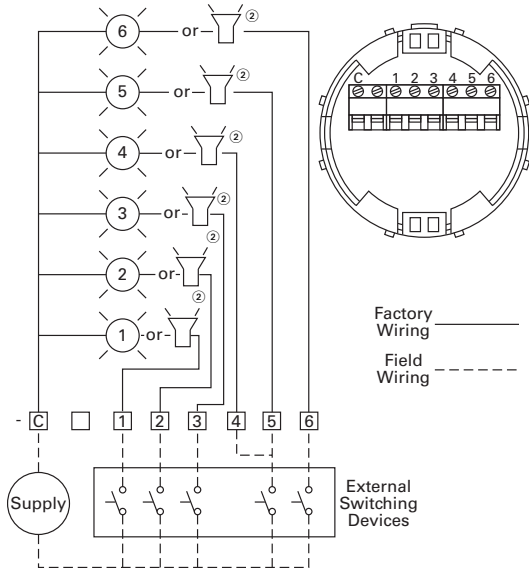

##### Flashing Base

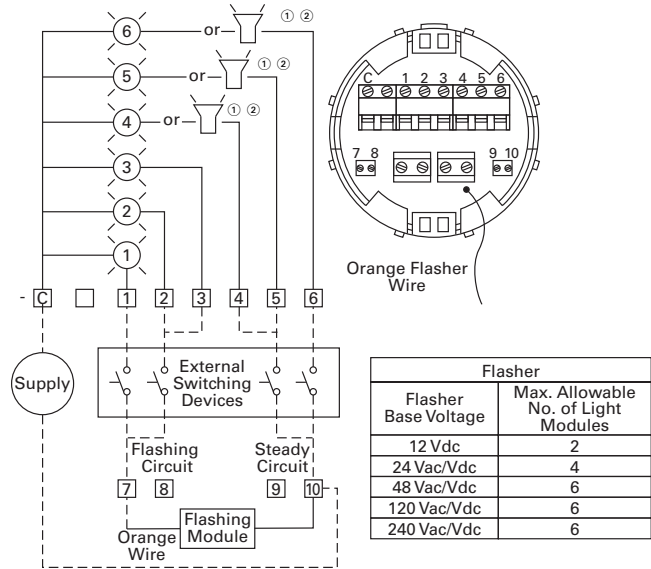

Description	Voltage	Catalog Number
<b>Standard Base</b>		
For use with steady incandescent or steady/flashing LED	12 Vac/Vdc to 240 Vac/Vdc	<b>E26BL</b>
<b>Flashing Base</b>		
Enables configuration of incandescent light modules for steady or flashing operation	12 Vdc	<b>E26BFV1</b>
	24 Vac/Vdc	<b>E26BFV2</b>
	48 Vac/Vdc	<b>E26BFV3</b>
	120 Vac/Vdc	<b>E26BFV4</b>
	240 Vac/Vdc	<b>E26BFV5</b>

#### Mounting Bases and Hubs

Description	Voltage	Catalog Number
<b>Standard Three-Hole Mounting Base</b>		
Standard three-hole mounting base	—	<b>E26S108</b>
<b>Standard Four-Hole Mounting Base</b>		
Standard four-hole mounting base	—	<b>E26S109</b>
<b>Myers Type Hub</b>		
3/4 in NPT threaded hub	—	<b>E26S104</b>

#### Notes

- ① Audible alarm units must be wired via the steady circuit on flashing base units.
- ② Audible alarm units can be wired in positions as shown but only one unit is permitted on each stack and unit must occupy the last or top mounting position.



## Alarm Units and Extension Tubes Components

E26B



## Audible Alarm Units-NEMA Type 1 (IP20) ①

Description	Voltage	Catalog Number
<b>Mono-Tonal</b>		
4.5 mA	12 Vac/Vdc	<b>E26BQV1</b>
12.6 mA	24 Vac/Vdc	<b>E26BQV2</b>
9.4 mA	48 Vac/Vdc	<b>E26BQV3</b>
11.5 mA	120 Vac/Vdc	<b>E26BQV4</b>
5.1 mA	240 Vac/Vdc	<b>E26BQV5</b>
<b>Bi-Tonal</b>		
4.5 mA	12 Vac/Vdc	<b>E26BNV1</b>
12.6 mA	24 Vac/Vdc	<b>E26BNV2</b>
9.4 mA	48 Vac/Vdc	<b>E26BNV3</b>
11.5 mA	120 Vac/Vdc	<b>E26BNV4</b>
5.1 mA	240 Vac/Vdc	<b>E26BNV5</b>
<b>Intermittent</b>		
4.5 mA	12 Vac/Vdc	<b>E26BPV1</b>
12.6 mA	24 Vac/Vdc	<b>E26BPV2</b>
9.4 mA	48 Vac/Vdc	<b>E26BPV3</b>
11.5 mA	120 Vac/Vdc	<b>E26BPV4</b>
5.1 mA	240 Vac/Vdc	<b>E26BPV5</b>

## Extension Tubes

Extension Tube

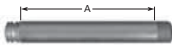

Description	Voltage	Catalog Number
<b>Extension "A" ②</b>		
0.79 in (20 mm) extension	—	<b>E26BHM</b>
6.30 in (160 mm) extension	—	<b>E26BJM</b>
14.17 in (360 mm) extension	—	<b>E26BKM</b>
29.92 in (760 mm) extension	—	<b>E26BMM</b>

Extension Tube

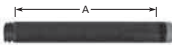

<b>Extension "A" ③</b>		
0.79 in (20 mm) extension	—	<b>E26BHU</b>
6.30 in (160 mm) extension	—	<b>E26BJU</b>
14.17 in (360 mm) extension	—	<b>E26BKU</b>
29.92 in (760 mm) extension	—	<b>E26BMU</b>

E26BRU



Right angle extension tube	—	<b>E26BRU</b>
----------------------------	---	---------------

## Notes

- ① Volume adjustment range: 64 dB to 90 dB typical current draw (mA).
- ② For use with standard mounting base or 3/4 in NPT threaded hub—gray aluminum.
- ③ For use with standard mounting base or 3/4 in NPT threaded hub—black aluminum.

### Replacement Parts

2

#### Stacklight Replacement Parts

Description	Notes	Number in Diagram	Catalog Number
Replacement cover	Normally included with stacklight base	1	E26S68
Replacement lens O-ring	Normally included with light modules	2	E26S106 ①
Replacement lenses	Clear	3	E26S38
	Red		E26S39
	Green		E26S40
	Yellow		E26S41
	Blue		E26S42
	Amber		E26S43
Replacement Xenon strobe dual high (does not include lenses)	12 Vac/Vdc	4	E26S33
	24 Vac/Vdc		E26S34
	48 Vac/Vdc		E26S35
	120 Vac		E26S36
	240 Vac		E26S37
Replacement diffusers	White — normally supplied with incandescent light modules	4	E26S31
	Clear — normally supplied with LED light modules		E26S32
Replacement lamps ②	12V	5	E26S8
	24V		E26S9
	48V		E26S10
	120V		E26S11
	240V		E26S12
Replacement extension tube O-rings	Normally included with extension tubes	6	E26S107 ③
Replacement mounting gasket ④	Normally included with stacklight base	7	E26S105
Lamp removal tool	For E26 and E22 incandescent lamps		E22BA3

#### Typical Stacklight Assemblies

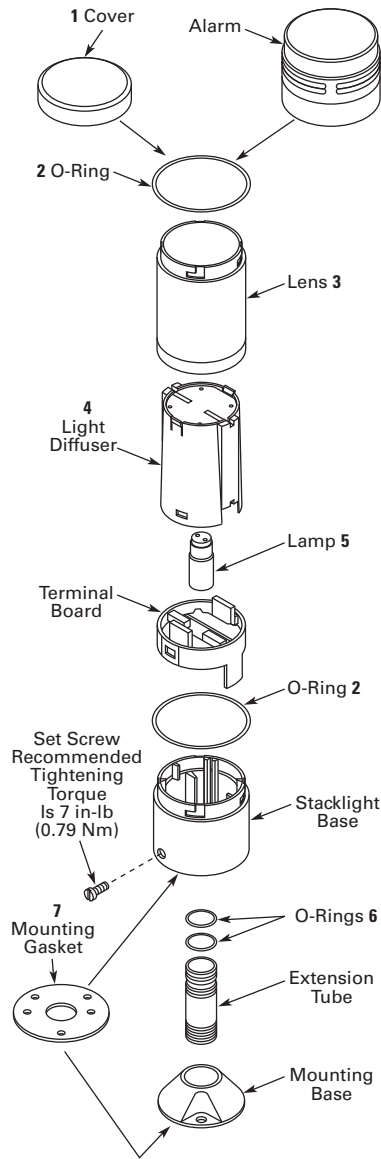

Typical Stacklight Assembly (Exploded View)

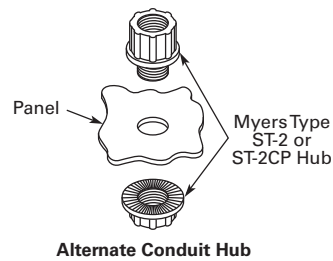

#### Notes

- ① Sold in packages of 5 pieces.
- ② For replacement LEDs, see table on **Page V7-T2-7**.
- ③ Sold in packages of 10 pieces.
- ④ Mounting gaskets have two sets of mounting holes—one set with center-to-center spacing of 1.75 in (44.5 mm) and another set with center-to-center spacing of 1.65 in (42 mm).

## Technical Data and Specifications

### General Specifications

Description	Specification
<b>Mechanical Ratings</b>	
Shock (IEC 68-2-27)	11 ms, 15g
Vibration (IEC 68-2-6)	10 sweeps 10–150 Hz, 2g
Bump (IEC 68-2-29)	1000 pulses, 6 ms, 15g
<b>Climate Conditions</b>	
Operating	Maximum 104°F (40°C) at 95% RH, Temperature –4° to 140°F (–20° to 60°C)
Storage	Temperature –40° to 176°F (–40° to 80°C)
<b>Materials</b>	
Cover	Polycarbonate
Lenses	Polycarbonate
Stacklight base	Nylon
Extension tubes	Aluminum
Mounting base	Zinc die cast
<b>Terminals</b>	
Single conductor	14–30 AWG (2.5–0.05 mm <sup>2</sup> )
Two conductors (same size)	18–26 AWG (0.75–0.14 mm <sup>2</sup> ) Do not mix solid and stranded wire in the same terminal
Recommended tightening torque	4.4–5.3 lb-in (0.5–0.6 Nm)
<b>Electrical Ratings</b>	
Insulation voltage (U <sub>i</sub> )	690V
Operational voltage (U <sub>o</sub> )	250V
Impulse withstand voltage (U <sub>imp</sub> )	1.5 kV
<b>Bulb Specifications</b>	
Incandescent lamp type	BA15d
Maximum lamp wattage	6W
Bulbs—average life	
Incandescent	7,000 to 12,000 hrs. (based on voltage)
Xenon flasher	20,000 hrs.
LED	60,000 to 100,000 hrs. (based on colors)
<b>LED/Incandescent Comparison</b>	
Incandescent lamps	Average operating life of 7,000 hours Each lamp can be used with any color lens Low cost results in short term savings
LED lamps	Average operating life of 60,000 to 100,000 hours Low power consumption Extended life results in long-term savings

## Ratings

Published theoretical lamp lives are based on ideal laboratory conditions and should be used for comparison only. Actual life may be shorter due to various application conditions.

2

### Stacklight Incandescent Application Data

Type of Light	Lamp Used	Approximate Current, mA per Light	Theoretical Lamp Life, Hours as Applied
12V	BA15d	417	7,000
24V	BA15d	208	7,000
48V	BA15d	104	7,000
110–140V	BA15d	36–50	7,000
220–260V	BA15d	23–27	12,000

### Xenon Flasher Application Data

Type of Light	Lamp Used	Approximate Current, mA per Light	Theoretical Lamp Life, Hours as Applied
12V	DC	460 mA	20,000
	AC	780 mA	20,000
24V	DC	190 mA	20,000
	AC	320 mA	20,000
48V	DC	100 mA	20,000
	AC	150 mA	20,000
120V	AC	60 mA <sup>①</sup>	20,000
240V	AC	30 mA <sup>①</sup>	20,000

### LED Application Data

Type of Light	Color	Cluster LED Approximate Current, mA at Rated Volts	Cylindrical LED Approximate Current, mA at Rated Volts	Theoretical Lamp Life, Hours as Applied
<b>Continuous/Flashing Stacklight LED</b>				
12 Vac/Vdc	Red	92	92	100,000
	Amber	92	92	100,000
	Yellow	92	92	100,000
	Green	60	60	80,000
	Blue	60	60	60,000
	White	60	60	60,000
24 Vac/Vdc	Red	47	47	100,000
	Amber	47	47	100,000
	Yellow	47	47	100,000
	Green	59	59	80,000
	Blue	59	59	60,000
	White	59	59	60,000
48 Vac/Vdc	Red	25	25	100,000
	Amber	25	25	100,000
	Yellow	25	25	100,000
	Green	18	18	80,000
	Blue	31	31	60,000
	White	31	31	60,000
60 Vac/Vdc	Red	25	25	100,000
	Amber	25	25	100,000
	Yellow	25	25	100,000
	Green	18	18	80,000
	Blue	17	17	60,000
	White	17	17	60,000
120 Vac/Vdc	Red	24	24	100,000
	Amber	24	24	100,000
	Yellow	24	24	100,000
	Green	17	17	80,000
	Blue	16	16	60,000
	White	16	16	60,000

#### Note

<sup>①</sup> Represents average current draw, 1.6A peak for 120V and 0.8A peak at 240V.

## Mounting Instructions

Stacklight bases may be mounted without the use of an extension tube or mounting base. If additional height is required, choose

0.8–30 in (20–760 mm) extension tubes that fit between the mounting base and stacklight base. The extension tubes are threaded

with 3/4 in NPT threads, allowing for direct connection to conduit fittings or threaded holes without the use of a mounting base.

### Base Mounting

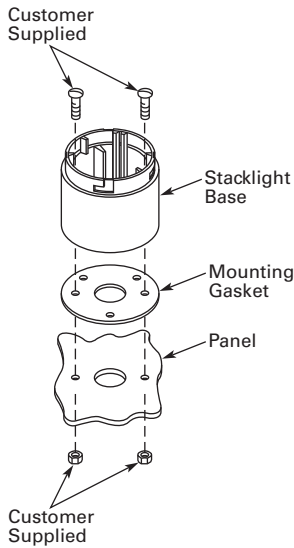

### Utilizing Extension Tube and Mounting Base

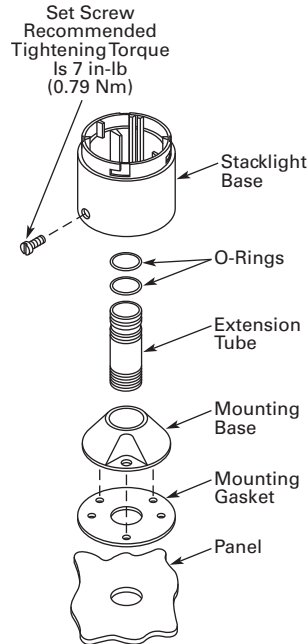

### Utilizing Extension Tube and 3/4 In (19.1 mm) Conduit Hub

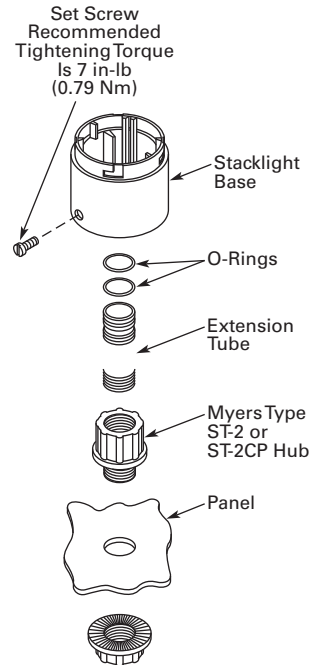

(Use Rubber-Jawed Pliers for Installation to Avoid Scratching the Black Anodized Coating)

## Mounting Dimensions

Approximate Dimensions in Inches (mm)

### Base Mounting

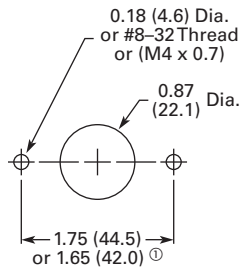

### Three-Hole Mounting for E26S108

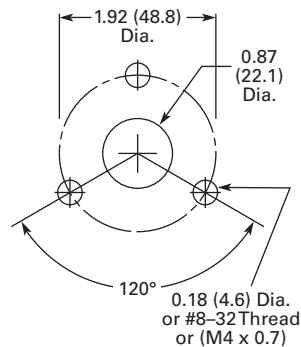

### Four-Hole Mounting for E26S109

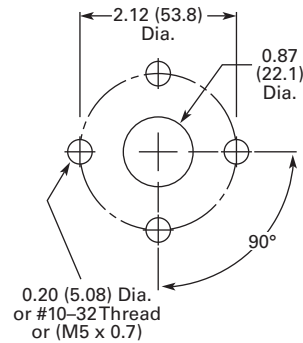

### Conduit Hub for E26S104—3/4 In (19.1 mm)

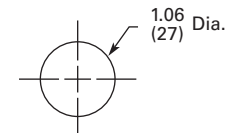

### Note

① Stacklight base and gasket are supplied as standard with two sets of base mount holes. One set with center-to-center spacing of 1.75 in (44.5 mm) and another set with center-to-center spacing of 1.65 in (42 mm).

# 2.1

## Stacklights

### E26 Series

#### Dimensions

Approximate Dimensions in Inches (mm)

2

#### Standard and Flashing Bases ①

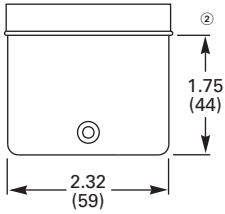

#### Alarm Units

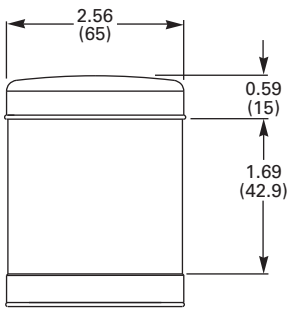

#### Assembled Extension Tubes

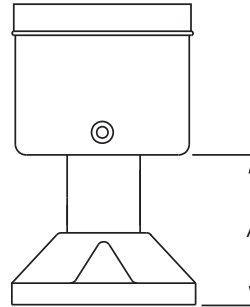

Tube Extension	Height A
0.79 (20)	1.77 (45)
6.30 (160)	7.28 (185)
14.17 (360)	15.16 (385)
29.92 (760)	30.91 (785)

#### Right Angle Extension Tubes

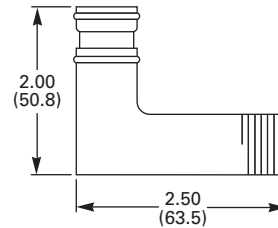

#### Notes

- ① Bases also suitable for mounting with extension tubes listed on **Page V7-T2-9**.
- ② Mounting gasket and cover are supplied as standard with stacklight bases.

Approximate Dimensions in Inches (mm)

**One-Light Unit Stacklight**

**Standard**

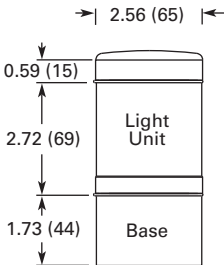

**With Alarm**

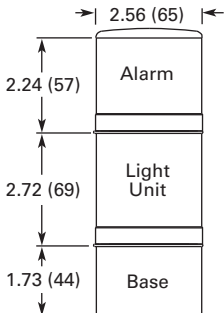

**With Xenon Flasher**

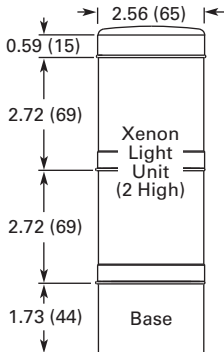

**Two-Light Unit Stacklight**

**Standard**

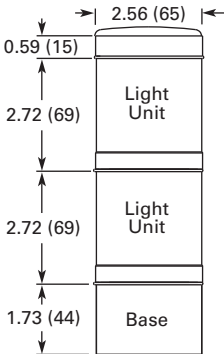

**With Alarm**

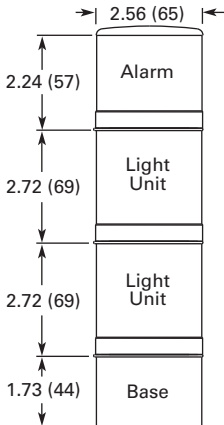

**With Xenon Flasher**

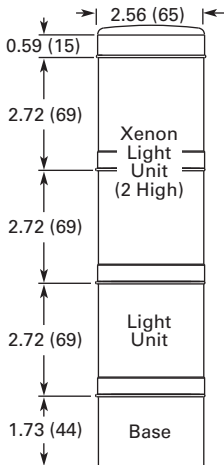

# 2.1

## Stacklights

### E26 Series

Approximate Dimensions in Inches (mm)

2

#### Three-Light Unit Stacklight

##### Standard

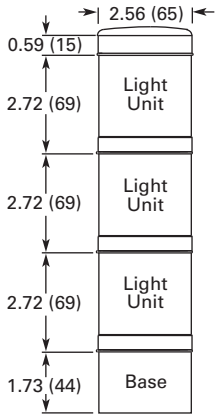

##### With Alarm

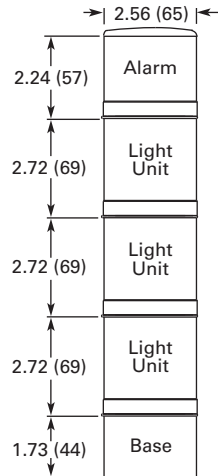

##### With Xenon Flasher

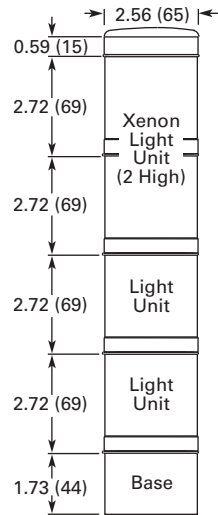

#### Light Modules

##### Standard

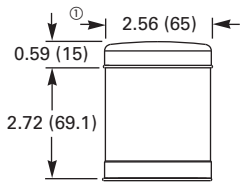

##### Xenon

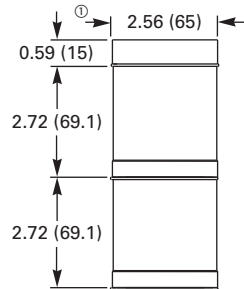

#### Note

① Cover included with stacklight base.