

HV Series

Hydraulic Cylinder



Up to 5000 PSI
Bore Sizes 1 1/2" through 8"
NFPA Interchangeable



Table Of Contents

Miller Hydraulic Cylinder Selection Guide.....	Page 1
Hydraulic Cylinder Features	2-3
Mounting Styles.....	4-5
1½" - 8" Bore Cylinder Reference Chart.....	6-7
Cylinder Mountings	8-43
Model 50 Series, Tie Rods Extended	8-9
Model 61, Rectangular Flange - Head End.....	10-11
Model 62, Rectangular Flange - Cap End.....	12-13
Model 65, Square Flange - Head End	14-15
Model 66, Square Flange - Cap End	16-17
Model 67 & 68, Rectangular Head or Cap	18-19
Model 72, Side Lugs	20-21
Model 73, Centerline Lugs.....	22-23
Model 74, Side Tapped.....	24-25
Model 77, End Lugs	26-27
Model 71, End Angles	28-29
Model 81, Trunnion - Head End.....	30-31
Model 82, Trunnion - Cap End.....	32-33
Model 83, Intermediate Trunnion	34-35
Model 84, Fixed Clevis.....	36-37
Model 86, Detachable Clevis	38-39
Model 90, Rear Eye	40-41
Model 94, Spherical Bearing	42-43
Double Rod End.....	44
Rod End Styles.....	45
Rod End Accessories.....	46-47
Rod End Couplers	48
Cyl. Stroke Adjustment & Other Modifications.....	49
Proximity Switches	50-53
Determining Port Size and Pressure Drop	54-55
Determining Stop Tube Requirements.....	57
Determining Column Strength of Piston Rod.....	58
Non-Sag Piston Rods.....	59
Keying and Pinning of Cylinders	60
Cyl. Installation and Maintenance Instructions.....	61
Cylinder Parts List and Seal Kits	62
Warranty	63
How To Order.....	64

Other Miller Air and Hydraulic Cylinders. Order Catalog by File No.

A Series Cylinders

Up to 250 PSI Permanently lubricated



Series A steel air cylinders are available in bore sizes from 1½" through 20" and up to 250 psi operating pressure. Standard NFPA dimensions and proven Miller design features. (File 7619)

AL Series Cylinders

Up to 250 PSI Permanently lubricated



Our new aluminum AL Series air cylinders are available in bore sizes from 1½" through 8". Operating pressures up to 250 PSI. Dimensions are NFPA Standard. (File 8564)

J Series Cylinders

500-2500 PSI



Our popularly-priced line of medium pressure hydraulic cylinders, with bore sizes from 1½" to 20". (File 7620)

H Series Cylinders

3000-5000 PSI



Miller's heavy-duty cylinder line for the most demanding hydraulic applications. Bore sizes from 1½" to 20". Heavy-duty construction. (File 7622)

Miller HV Series Hydraulic Cylinder Selection Guide

Rapid Delivery from Stock Components

The Miller HV Series of heavy duty hydraulic cylinders is available in 23 NFPA mounting styles and bore sizes from 1½" to 8". Miller produces components for the HV Series of cylinders at all five of the Miller manufacturing facilities in North America. This enables unmatched delivery of custom stroke length cylinders. Out normal delivery for a standard cylinder is 3 to 5 working days.

HV Series hydraulic cylinders are considered standard if they fall within the following criteria:

All bore sizes; Standard rod end; Standard or first oversize rod diameter; With or without optional cushions; All mounting styles except Models 73, 89, and 94; Standard seals, Standard bushing retention (see chart on page 6).

Large quantities, or special modifications will require additional delivery time. Please call Miller Fluid Power at 1-800-323-2520 with your specific delivery requirements.

Selecting a Miller Hydraulic Cylinder

Miller hydraulic cylinders are selected and sized primarily based on force requirements and available operating pressure. The HV Series is an economical heavy-duty design intended for normal industrial service at internal operating pressures up to 3,000 PSI (5,000 PSI non-shock). It is available in 21 mounting styles and bore sizes from 1½" to 8".

HV Series Pressure Rating

Moderate Service (non-shock) — 5,000 PSI

Severe Service (shock loaded) — 3,000 PSI

Proof Pressure — 6,000 PSI

Note: Certain mounting styles and over-sized rod combinations have pressure rating limitations due to their inherent design. See mounting style catalog page for details.

Other Miller Hydraulic Cylinder Models

When evaluating your application, please review our other hydraulic cylinder models to be sure that you are selecting the model most appropriate to your requirements.

Certified Dimensions

Miller Fluid Power guarantees that all cylinders ordered from this catalog will have the dimensions as specified in this catalog — no waiting for special drawings to be prepared and sent. When required however, special certified drawings are available at extra cost.

Steps in Selecting the Correct Cylinder

Detailed engineering information on bore size selection, oversize and non-sag rods, stop tubes, determining port and pipe size, and the like is located in this catalog. See Table of Contents on previous page.

Step 1 — Determine the correct cylinder bore size required based upon operating pressure and thrust required (See page 57).

Step 2 — Select the mounting style which is required for your application (see pages 4 & 5).

Step 3 — On the appropriate catalog page for the mounting style selected, review bore and rod sizes available and pressure rating limitations, if any.

Step 4 — Choose a rod end style (page 45) and, if desired, rod end accessories (pages 46-48), and optional cushions.

Step 5 — Consider the conditions listed below which may require further modifications to the cylinder you have selected. Application Engineering assistance is readily available by contacting any of the Miller facilities listed on the back cover of this catalog.

Step 6 — Refer to "How to Order" section on page 68 to develop the part number and place your order.

Application Condition	Check the following	Application Condition	Check the following
Rapid Starts or Stops	Use severe service pressure rating only. Confirm that sufficient thrust is available to accelerate or decelerate cylinder and load within prescribed distances. If optional cushions are selected and will be used to reduce shock during deceleration, check that peak pressures will be within acceptable limits.	Long Horizontal Stroke	Check to see if a non-sag piston rod is required to prevent excess sagging and resultant premature bushing and piston wear.
Long Stroke	Check whether stop tube may be required to prevent excess bearing loads and wear.	Operating Temperatures	The standard operating temperature range of the Urethane seals used in the HV Series is -20°F to +160°F. For temperatures in excess of that range, optional Viton® seals will be required.
High Column Loading-Long Push Stroke	Determine if standard size piston rod is strong enough to accommodate intended load without buckling.	Sufficient Speed	Confirm that standard port size permits sufficient flow to accommodate speed requirements. Fluid flow velocity should not exceed 15 feet per sec.
Loads	When high side loads and similar severe or unusual operating conditions are anticipated, please consult a Miller application engineer for recommendations concerning optional bushing material and design.	Fluid Compatibility	The standard HV Urethane seals are compatible with petroleum based fluids only. Viton seals are available for use with water glycol, water/oil emulsions and phosphate ester fluids up to 150°F. For cylinders using these fluids in excess of 150°F the Miller Series H cylinders with Teflon® seals are recommended.

Fluid power cylinders are designed to be linear actuators. They are intended to provide motion and force along the centerline of the rod. Since they have limited capacity to withstand eccentric or radial loads, they should not be employed as linear bearings. Good machine design practice requires that proper alignment be maintained to avoid excessive bearing loads. Any premature failure resulting from side loading is not considered a warranty failure. If your design involves the possibility of side loading, please contact the Miller Fluid Power application engineering department.

Miller HV Series Hydraulic Cylinders

Standard Design Features to Maximize Performance and Uptime

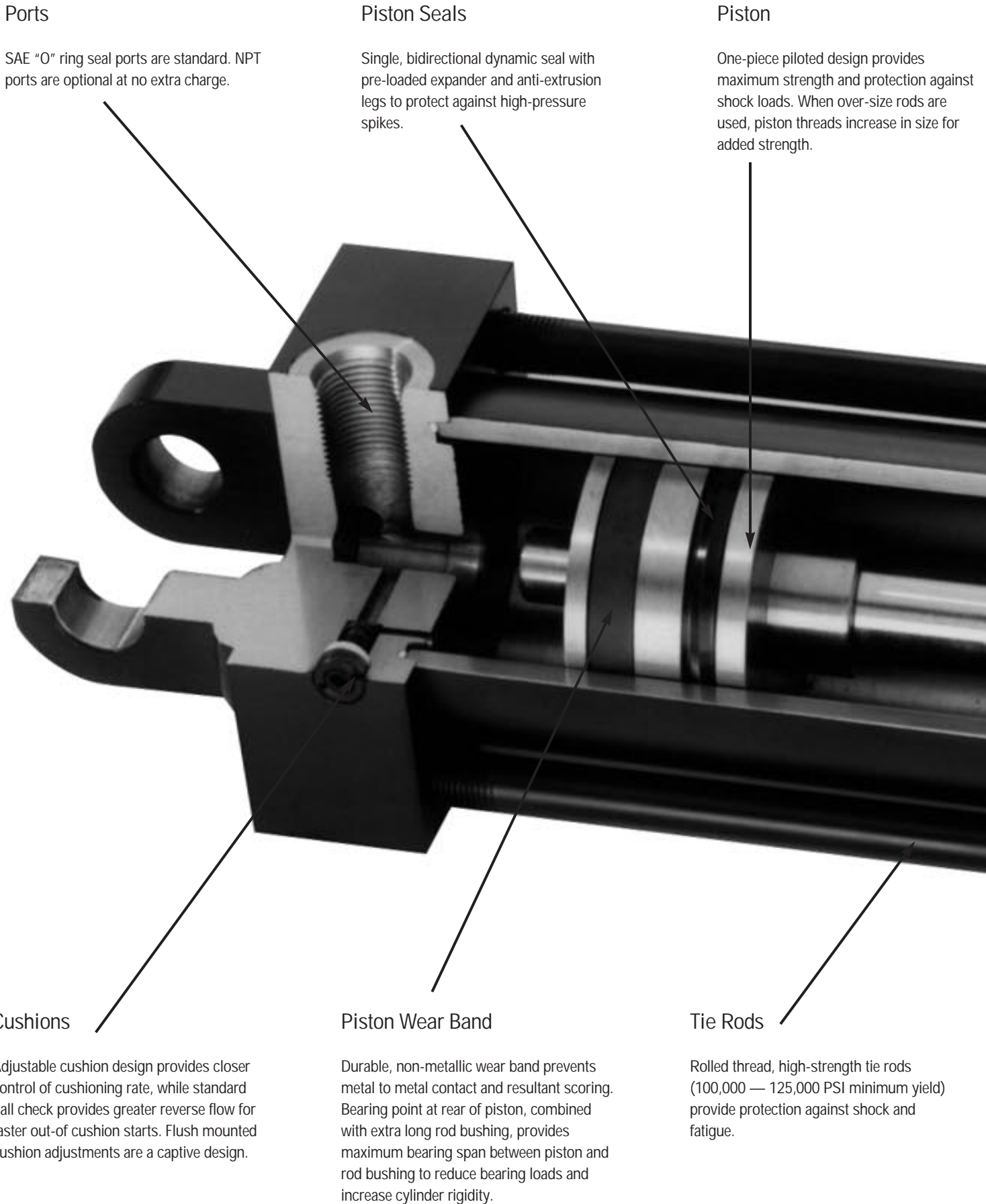

Miller HV Series Hydraulic Cylinders

Standard Design Features to Maximize Performance and Uptime

Tube End Seal

Patented SHEF Teflon® tube-end seal prevents leakage caused by seal shearing and extrusion from shock loads, is compatible with all commonly used fluids.

Rod Seal

Pre-load expander ring provides positive seal contact at high or low pressures for "zero" leakage.

Bushing

Piloted nodular iron bushing assures concentricity, protects against side loads and provides 400% longer bearing life than conventional bronze bushings. Easily removed, using a common Allen wrench, without disturbing cylinder tie rods.

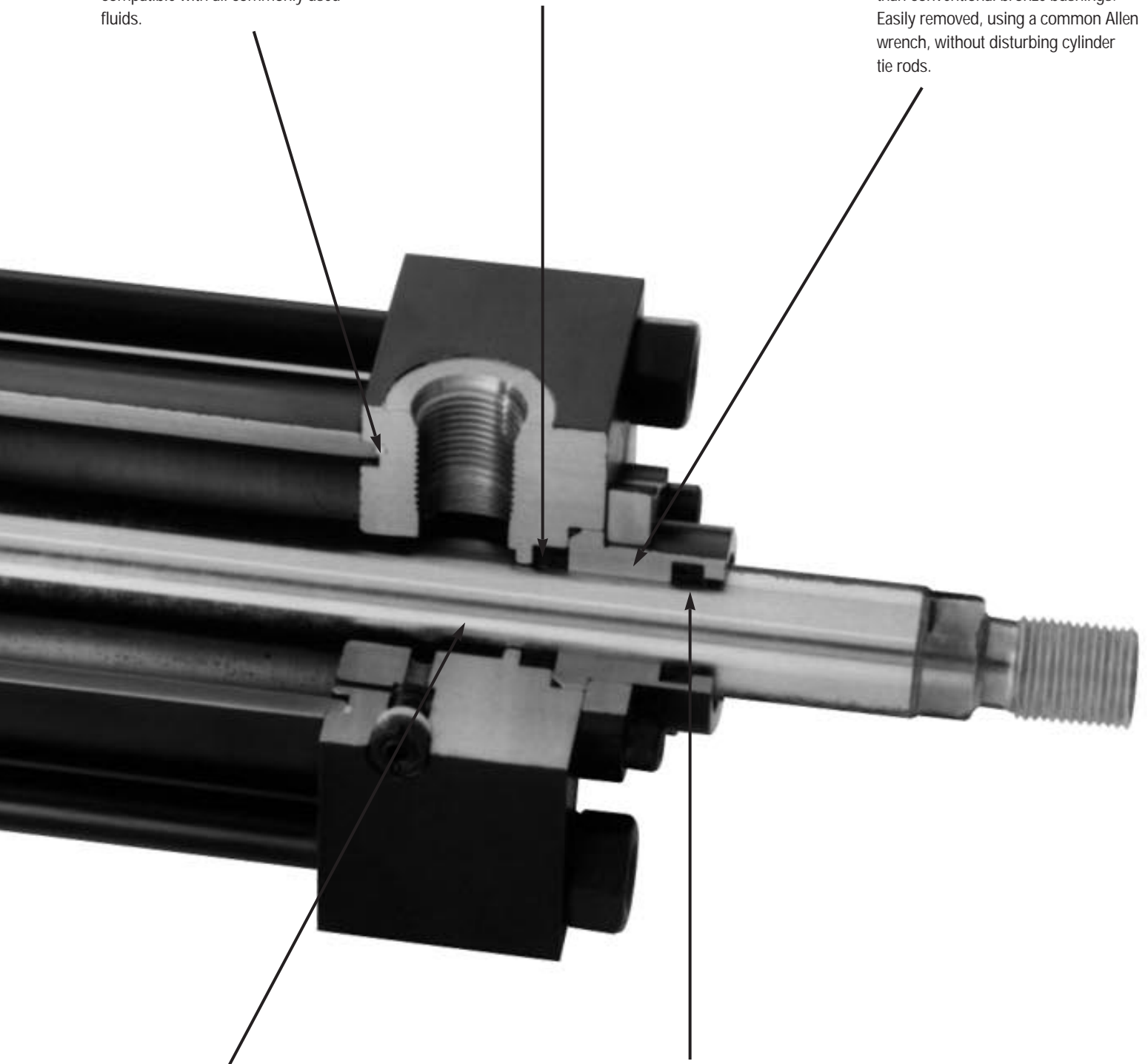

Piston Rod

Piston rods are case hardened and chrome plated to resist mechanical damage and scratching; ground and polished to extend bushing and seal life. External rod diameter reduced slightly at flats for easy rod seal replacement.

Double-Lip Wiper

Double-lip design rod wiper/seal protects piston rod and bushing from external contamination and provides a secondary back-up rod seal.

Centerline

The preferred cylinder installation method, centerline mounting places the mounting bolts in simple tension so that the mounting mechanism is protected from compound forces. Centerline mounting is a rigid mounting style and thus requires accurate cylinder alignment to prevent damage to cylinder working parts.

Miller Series HV mounting configurations that provide centerline support are tie-rod mounts, flange mounts with square or rectangular flanges fastened to the cylinder head or cap, rectangular head and cap cylinders, and centerline lug cylinders.

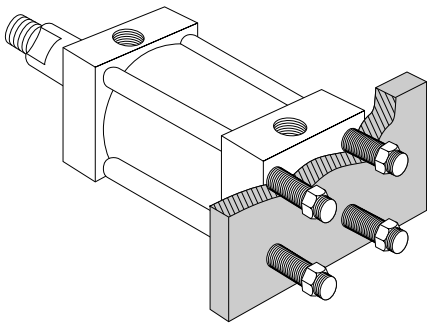

Centerline mounting is preferable since it prevents compound forces from acting on the mounting bolts (tie rod model shown).

Foot

Foot mounting secures the cylinder along its side. Since the mounting surface plane is thus not centered directly on the line of force, the mounting bolts are subjected to a significant amount of shear stress. The cylinder should be pinned or keyed to absorb the stress of shear loads and allow the mounting bolts to remain in simple tension. Because foot mounts are rigid, they require accurate cylinder alignment.

Lugs, either welded onto the sides of the head and cap or attached to the ends of the cylinder, are the usual form of foot mounts. Centerline lugs are available as Model HV 73. See page 24. As an alternative to the use of lugs, flush mounting incorporates tapped mounting holes on the sides of the cylinder head and cap.

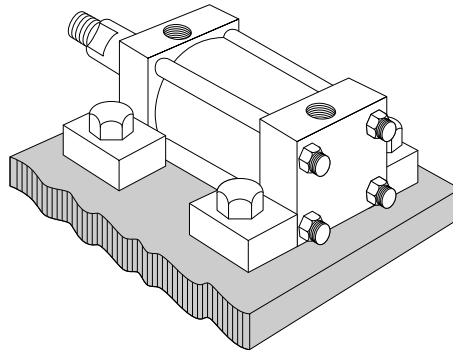

Foot mounting secures the cylinder on its side, but can subject the mounting bolts to compound stress (cylinder side lugs shown).

Pivot

Pivot mounting is used when the cylinder must pivot during piston motion. Clevis and trunnion mounts are the two methods used to allow this motion.

The clevis end design locates the pivot point at the cap end of the cylinder. Trunnion mounting uses trunnions on the head, cap or side of the cylinder to allow it to pivot at any of three locations. Both clevis and trunnion mounting configurations allow the cylinder to pivot in one plane only.

The rear eye cylinder is an additional pivot-mounted cylinder. Essentially a reversal of the fixed clevis assembly, the rear eye cylinder locates a clevis eye on the cylinder cap and mounts to a clevis bracket on the load surface.

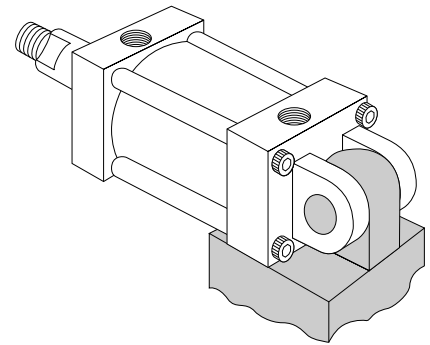

Pivot mounting allows the cylinder to pivot during piston motion (clevis method shown).

Centerline Mounts

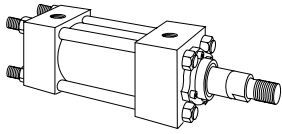

Tie Rod Models 50*, 51, (NFPA MX1), 52 (NFPA MX2) 53 (NFPA MX3), 54 (NFPA MX4)
See page 8

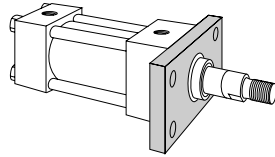

Rectangular Flange/Head End
Model 61 (NFPA MF1)
See page 10

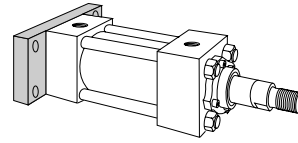

Rectangular Flange/Cap End
Model 62 (NFPA MF2)
See page 12

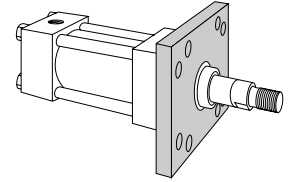

Square Flange/Head End
Model 65 (NFPA MF5)
See page 14

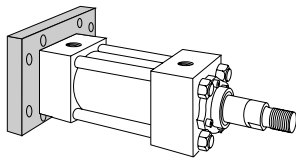

Square Flange/Cap End
Model 66 (NFPA MF6)
See page 16

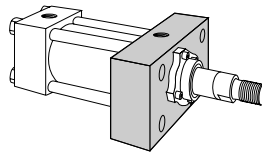

Rectangular Head
Model 67 (NFPA ME5)
See page 18

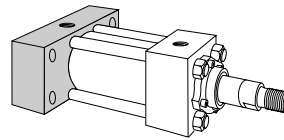

Rectangular Cap
Model 68 (NFPA ME6)
See page 18

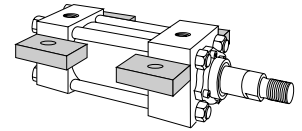

Centerline Lug
Model 73 (NFPA MS3)
See page 22

Foot Mounts

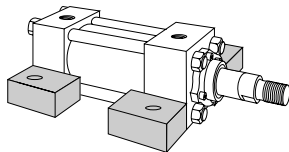

Side Lug
Model 72 (NFPA MS2)
See page 20

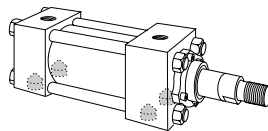

Side Tapped
Model 74 (NFPA MS4)
See page 24

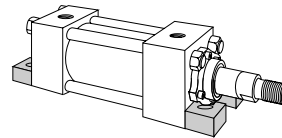

End Lug
Model 77 (NFPA MS7)
See page 26

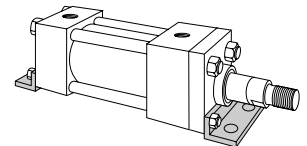

End Angle
Model 71 (NFPA MS1)
See page 28

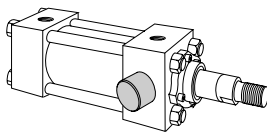

Trunnion/Head End
Model 81 (NFPA MT1)
See page 30

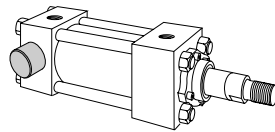

Trunnion/Cap End
Model 82 (NFPA MT2)
See page 32

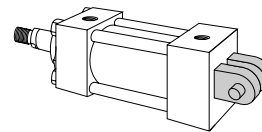

Fixed Clevis
Model 84 (NFPA MP1)
See page 36

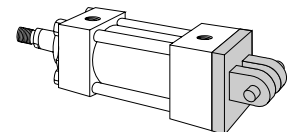

Detachable Clevis
Model 86 (NFPA MP2)
See page 38

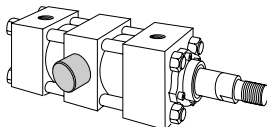

Intermediate Trunnion
Model 89 (NFPA MT4)
See page 34

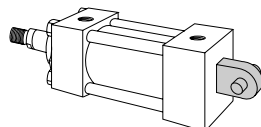

Rear Eye
Model 90 (NFPA MP3)
See page 40

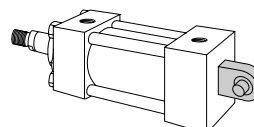

Spherical Eye
Model 94
See page 42

* Model 50 - No tie rod extension
Model 51 - Tie rods extended head and cap
Model 52 - Tie rods extended cap end only
Model 53 - Tie rods extended head end only
Model 54 - Tie rods (2) extended head and cap at position No. 3

Miller H Series Hydraulic Cylinders

1½" thru 20" Bore Cylinders

Bushing Retainer Style

While the standard Miller cylinder design utilizes a bolted bushing, on certain combinations of bore size, rod size and/or mounting style a bolted bushing would interfere with the tie rod nuts. In those cases, a square retainer-held bushing is used.

The selection chart below lists all the possible combinations, with a ● indicating bolted type bushing and a ■ indicating use of the full square retainer method.

Please note that dimensional information is provided on the appropriate catalog pages for the two different styles.

MOUNT CONFIGURE MODEL NO.	1½" BORE		2" BORE		2½" BORE		3¼" BORE		4" BORE		5" BORE			6" BORE		7" BORE		8" BORE								
	STD ROD	OS ROD	STD ROD	OS ROD	STD ROD	OS ROD	STD ROD	OS ROD	STD ROD	OS ROD	STD ROD	OS ROD		STD ROD	OS ROD	STD ROD	OS ROD	STD ROD	OS ROD							
	5/8 **	1 **	1 **	1 3/8 **	1 **	1 3/8 **	1 3/4	1 3/8 **	1 3/4	2	1 3/4	2	2 1/2	2	2 1/2	3	3 1/2	2 1/2	3, 3 1/2	4	3	3 1/2, 4 4 1/2	5	3 1/2	4	4 1/2, 5 5 1/2
50, 52	●	■	●	■	●	●	●	●	●	●	●	●	●	●	●	●	●	●	●	●	●	●	●	●	●	●
51	■	■	■	■	●	●	●	●	●	●	●	●	●	●	●	●	●	●	●	●	●	●	●	●	●	●
53	■	■	■	■	●	●	●	●	●	●	●	●	●	●	●	●	●	●	●	●	●	●	●	●	●	●
54	■	■	■	■	●	●	●	●	●	●	●	●	●	●	●	●	●	●	●	●	●	●	●	●	●	●
61	■	■	■	■	●	■	■	●	●	■	●	●	●	●	●	●	●	●	●	●	●	●	●	●	●	●
62	●	■	●	■	●	●	●	●	●	●	●	●	●	●	●	●	●	●	●	●	●	●	●	●	●	●
65	■	■	■	■	●	■	■	●	●	■	●	●	●	●	●	●	●	●	●	●	●	●	●	●	●	●
66	●	■	●	■	●	●	●	●	●	●	●	●	●	●	●	●	●	●	●	●	●	●	●	●	●	●
67	●	●	●	●	●	●	●	●	●	●	●	●	●	●	●	●	●	●	●	●	●	●	●	●	●	●
68	●	■	●	■	●	●	●	●	●	●	●	●	●	●	●	●	●	●	●	●	●	●	●	●	●	●
71	■	■	■	■	■	■	■	■	■	■	■	■	■	■	■	■	■	■	■	■	N/A	N/A	N/A	N/A	N/A	N/A
72	●	■	●	■	●	●	●	●	●	●	●	●	●	●	●	●	●	●	●	●	●	●	●	●	●	●
73	●	■	●	■	●	●	●	●	●	●	●	●	●	●	●	●	●	●	●	●	●	●	●	●	●	●
74	●	■	●	■	●	●	●	●	●	●	●	●	●	●	●	●	●	●	●	●	†	†	●	●	†	
77	●*	■+	●*	■+	●	●*	■+	●	●	■+	●	●	■	●	●	●	■	●	●	■	●	●	N/A	●	●	●
81	●	■	●	■	●	●	●	●	●	●	●	●	●	●	●	●	●	●	●	●	●	●	●	●	●	●
82	●	■	●	■	●	●	●	●	●	●	●	●	●	●	●	●	●	●	●	●	●	●	●	●	●	●
84	●	■	●	■	●	●	●	●	●	●	●	●	●	●	●	●	●	●	●	●	●	●	●	●	●	●
86	●	■	●	■	●	●	●	●	●	●	●	●	●	●	●	●	N/A	N/A	N/A	N/A	N/A	N/A	N/A	N/A	N/A	N/A
89	●	■	●	■	●	●	●	●	●	●	●	●	●	●	●	●	●	●	●	●	●	●	●	●	●	●
90	●	■	●	■	●	●	●	●	●	●	●	●	●	●	●	●	●	●	●	●	●	●	●	●	●	●
94	●	■	●	■	●	●	●	●	●	●	●	●	●	●	●	●	●	●	●	●	N/A	N/A	N/A	N/A	N/A	N/A

Mounting Configuration (Model No.)	BORE/ROD SIZE AVAILABILITY										
	10" Bore		12" Bore		14" Bore		16" Bore		18" Bore		20" Bore
	STD. ROD	OVERSIZED RODS	STD. ROD	OVERSIZED RODS	STD. ROD	OVERSIZED RODS	STD. ROD	OVERSIZED ROD	STD. ROD	OVERSIZED RODS	STD. ROD
	4½	5, 5½, 7	5½	7, 8	8, 9, 10	8	9, 10	8	9, 10	10	10
63, 64, 84, 90	●	●	●	●	●	●	●	●	●	●	●
81, 82, 72, 73	●	●	●	●	NA	NA	NA	NA	NA	NA	NA
89	●	●	●	●	NA	NA	NA	NA	NA	NA	NA

- Bolted type bushing construction
- Full Square retainer construction
- * Mounting lugs at head end must be removed before bushing
- ** Bolted Bushing Construction Rated at 3000psi
- N/A Not Available

- † If rod eye is used on Style 2 rod end, it will interfere with Model 77 mounting lugs.
- ‡ Reduced pressure ratings due to shallow tapped mounting holes. Consult Miller Application Engineering.

Miller HV Series Hydraulic Cylinders

1½" thru 8" Bore Cylinders Port Size Reference Chart

1½" thru 8" Bore Size Reference Chart
SAE Ports Standard — NPT Ports Optional

Cylinder Bore Diam. (inches)	Rod Diameter (inches)	Standard SAE Port			Optional NPT Port		4 Bolt SAE 5000psi
		NFPA Standard	Max Oversize		Standard	** Maximum Oversize	
			Head	Cap			
1½	5/8	(-8)	*(-10)	(-10)	½ - 14	¾ - 14	NA
	1	(-8)	◆	◆	½ - 14	¾ - 14	
2	1	(-8)	*(-10)	(-10)	½ - 14	¾ - 14	NA
	1 3/8	(-8)	◆	◆	½ - 14	¾ - 14	
2½	1	(-8)	*(-10)	(-10)	½ - 14	¾ - 14	½
	1 3/8	(-8)	*(-10)	(-10)	½ - 14	¾ - 14	
	1 3/4	(-8)	*(-10)	(-10)	½ - 14	¾ - 14	
3¼	1 3/8	(-12)	*(-14)	(-14)	¾ - 14	1 - 11½	¾
	1 3/4	(-12)	*(-14)	(-14)	¾ - 14	1 - 11½	
	2	(-12)	(-14)	(-14)	¾ - 14	1 - 11½	
4	1 3/4	(-12)	*(-14)	(-14)	¾ - 14	1 - 11½	¾
	2	(-12)	(-14)	(-14)	¾ - 14	1 - 11½	
	2 1/2	(-12)	(-14)	(-14)	¾ - 14	1 - 11½	
5	2	(-12)	**(-14)	**(-14)	¾ - 14	1 - 11½	¾
	2 1/2	(-12)	**(-14)	**(-14)	¾ - 14	1 - 11½	
	3	(-12)	**(-14)	**(-14)	¾ - 14	1 - 11½	
	3 1/2	(-12)	**(-14)	**(-14)	¾ - 14	1 - 11½	
6	2 1/2	(-16)	◆	◆	1 - 11½	1 1/4 - 11½	1
	3	(-16)	◆	◆	1 - 11½	1 1/4 - 11½	
	3 1/2	(-16)	◆	◆	1 - 11½	1 1/4 - 11½	
	4	(-16)	◆	◆	1 - 11½	1 1/4 - 11½	
7	3	(-20)	◆	◆	1 1/4 - 11½	1 1/2 - 11½	1 1/4
	3 1/2	(-20)	◆	◆	1 1/4 - 11½	1 1/2 - 11½	
	4	(-20)	◆	◆	1 1/4 - 11½	1 1/2 - 11½	
	4 1/2	(-20)	◆	◆	1 1/4 - 11½	1 1/2 - 11½	
	5	(-20)	◆	◆	1 1/4 - 11½	1 1/2 - 11½	
8	3 1/2	(-24)	◆	◆	1 1/2 - 11½	2 - 11½	1 1/2
	4	(-24)	◆	◆	1 1/2 - 11½	2 - 11½	
	4 1/2	(-24)	◆	◆	1 1/2 - 11½	2 - 11½	
	5	(-24)	◆	◆	1 1/2 - 11½	2 - 11½	
	5 1/2	(-24)	◆	◆	1 1/2 - 11½	2 - 11½	

1½" thru 8" Bore
Port Size Reference Chart

DASH Number	Tube O.D. (in.)	Thread Size (in.)
(8)	.50	.75 - 16
(10)	.62	.88 - 14
(12)	.75	1.06 - 12
(14)	.88	1.18 - 12
(16)	1	1.31 - 12
(20)	1.25	1.62 - 12
(24)	1.50	1.88 - 12

Miller SAE O-Ring ports conform to SAE standard J514 (straight thread O-Ring boss).

* "R" construction only ** Welded ◆ Consult Miller Application Engineering
Note: All Optional Maximum Oversize NPT Ports are Welded.

Miller HV Series Hydraulic Cylinders

Tie Rods Extended
1½" – 8" Bore Cylinders

Model 52-B (NFPA MX2) Bolted Bushing Tie Rods Extended Cap End

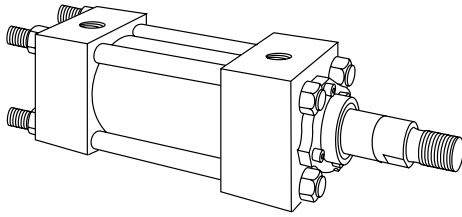

Mounting Dimensions (see tables on opposite page)

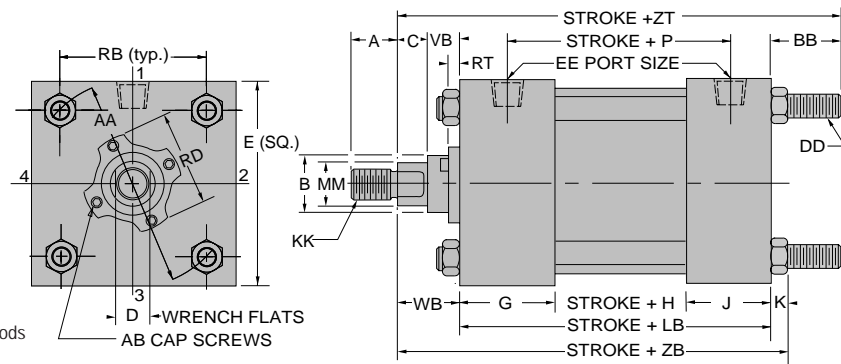

Also Available
Model 50-B No Tie Rods Extended, Model 51-B (NFPA MX1) Tie Rods
Extended both ends, Model 53-B (NFPA MX3)
Tie Rods Extended head end, Model 54-B (NFPA MX4)
two Tie Rods Extended both ends at position #3.
All of the above models can be dimensioned from Model 52-B shown.

Model 52-R (NFPA MX2) Square Retainer Held Bushing Tie Rods Extended Cap End

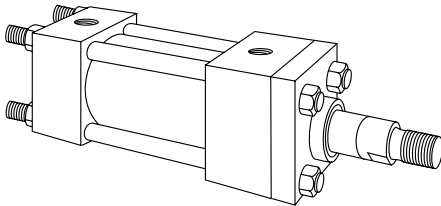

Mounting Dimensions (see tables on opposite page)

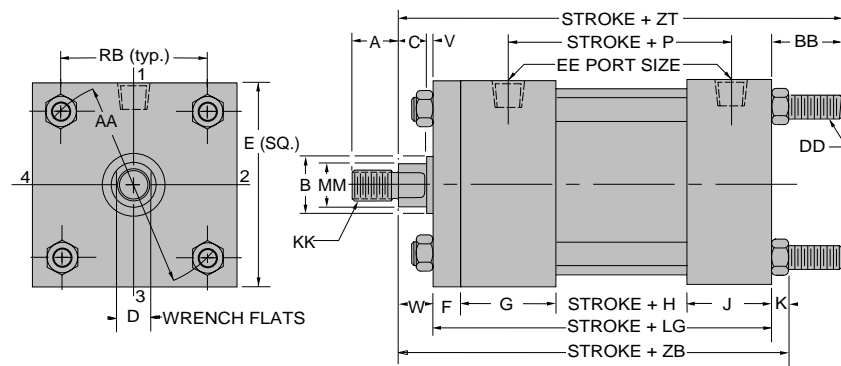

Also Available
Model 50-R No Tie Rods Extended, Model 51-R (NFPA
MX1) Tie Rods Extended both ends, Model 53-R (NFPA
MX3)
Tie Rods Extended head end, Model 54-R (NFPA MX4)
two Tie Rods Extended both ends at position #3. All of
the above models can be dimensioned from Model 52-R
shown.

Common Rod End Styles & Dimensions (See page 45 for complete listing of rod end styles)

Style No. 2-Standard
Threaded on Turndown Section

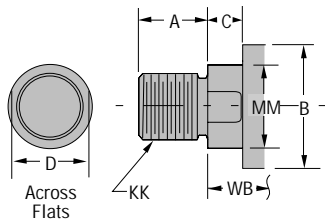

Style No. 4
Short Rod End-Internal Threads

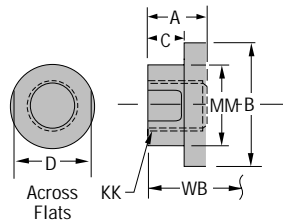

Style No. 5
Threaded Intermediate Male

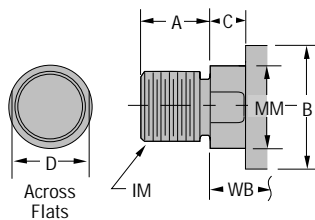

Style No. 6
Studded Rod End
(Available Thru 2" Rod Diameter)

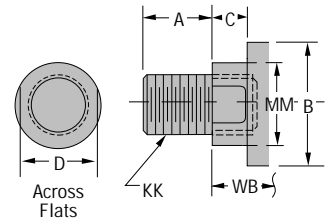

Miller HV Series Hydraulic Cylinders

Tie Rods Extended 1½" – 8" Bore Cylinders

Cylinder Body Dimensions

Bore Size	E	F	G	J	K	AA	BB	DD	*EE		RB
									SAE	NPT	
1½	2½	¾	1¾	1½	¾	2.3	1¾	¾-24	-8	½	1.63
2	3	⅝	1¾	1½	7/16	2.9	1 ¹³ / ₁₆	½-20	-8	½	2.05
2½	3½	⅝	1¾	1½	7/16	3.6	1 ¹³ / ₁₆	½-20	-8	½	2.55
3¼	4½	¾	2	1¾	9/16	4.6	2 ⁵ / ₁₆	⅝-18	-12	¾	3.25
4	5	7/8	2	1¾	9/16	5.4	2 ⁵ / ₁₆	⅝-18	-12	¾	3.82
5	6½	7/8	2	1¾	1 ³ / ₁₆	7.0	3 ³ / ₁₆	7/8-14	-12	¾	4.95
6	7½	1	2¼	2¼	1 ⁵ / ₁₆	8.1	3 ³ / ₈	1-14	-16	1	5.73
7	8½		2¾	2¾	1	9.3	4½	1½-12	-20	1¼	6.58
8	9½		3	3	1¼	10.6	4½	1¼-12	-24	1½	7.50

* SAE ports are standard, NPT ports are available at no extra charge.
† LD dimension is for double rod end models. See page 44.

Add Stroke

H	LB	†LD	LG	P
1¾	4 ⁵ / ₈	4 ⁷ / ₈	5	2 ⁷ / ₈
1¾	4 ⁵ / ₈	4 ⁷ / ₈	5¼	2 ⁷ / ₈
1½	4¾	5	5 ³ / ₈	3
1¾	5½	5¾	6¼	3½
2	5¾	6	6 ⁵ / ₈	3¾
2½	6¼	6½	7½	4¼
2¾	7 ³ / ₈	7 ³ / ₈	8 ³ / ₈	4 ⁷ / ₈
3	8½	8½		5 ³ / ₈
3½	9½	9½		6½

Rod End Dimensions

Bore Size	Rod Dia (MM)	A	B -.001 to -.003	C	D	V	W	AB	IM Style 5	KK Styles 2,4&6	RD (Max.)	RT	VB	WB
1½	5/8	¾	1.125	¾	½	¼	5/8	10-32	½-20	7/16-20	1.972	.316	5/8	1
	1	1⅛	1.500	½	7/8	½	1		7/8-14	¾-16				
2	1	1⅛	1.500	½	7/8	¼	¾	¼-28	7/8-14	¾-16	2.472	.328	7/8	1¾
	1¾	1⅝	2.000	⅝	1⅛	¾	1		1¼-12	1-14				
2½	1	1⅛	1.500	½	7/8	¼	¾	¼-28	7/8-14	¾-16	2.472	.328	7/8	1¾
	1¾	1⅝	2.000	⅝	1⅛	¾	1	¼-28	1¼-12	1-14	2.972	.328	1	1⅝
	1¾	2	2.375	¾	1½	½	1¼	¼-28	1½-12	1¼-12	3.470	.313	1⅛	1⅞
3¼	1¾	1⅝	2.000	⅝	1⅛	¼	7/8	¼-28	1¼-12	1-14	2.972	.328	1	1⅝
	1¾	2	2.375	¾	1½	¾	1⅛	¼-28	1½-12	1¼-12	3.470	.313	1⅛	1⅞
	2	2¼	2.625	7/8	1½	¾	1¼	¼-28	1¾-12	1½-12	3.720	.313	1⅛	2
4	1¾	2	2.375	¾	1½	¼	1	¼-28	1½-12	1¼-12	3.470	.313	1⅛	1⅞
	2	2¼	2.625	7/8	1½	¼	1⅛	¼-28	1¾-12	1½-12	3.720	.313	1⅛	2
	2½	3	3.125	1	2⅛	¾	1¾	¼-28	2¼-12	1⅞-12	4.252	.313	1¼	2¼
5	2	2¼	2.625	7/8	1½	¼	1⅛	¼-28	1¾-12	1½-12	3.720	.313	1⅛	2
	2½	3	3.125	1	2⅛	¾	1¾	¼-28	2¼-12	1⅞-12	4.252	.313	1¼	2¼
	3	3½	3.750	1	2⅝	¾	1¾	¼-28	2¾-12	2¼-12	4.752	.313	1¼	2¼
	3½	3½	4.250	1	3	¾	1¾	¼-28	3¼-12	2½-12	5.252	.313	1¼	2¼
6	2½	3	3.125	1	2⅛	¼	1¼	¼-28	2¼-12	1⅞-12	4.252	.313	1¼	2¼
	3	3½	3.750	1	2⅝	¼	1¼	¼-28	2¾-12	2¼-12	4.752	.313	1¼	2¼
	3½	3½	4.250	1	3	¼	1¼	¼-28	3¼-12	2½-12	5.252	.313	1¼	2¼
	4	4	4.750	1	3¾	¼	1¼	5/16-24	3¾-12	3-12	5.939	.610	1¼	2¼
7	3	3½	3.750	1	2⅝			¼-28	2¾-12	2¼-12	4.752	.313	1¼	2¼
	3½	3½	4.250	1	3			¼-28	3¼-12	2½-12	5.252	.313	1¼	2¼
	4	4	4.750	1	3¾			5/16-24	3¾-12	3-12	5.939	.610	1¼	2¼
	4½	4½	5.250	1	3⅞			5/16-24	4¼-12	3¼-12	6.439	.610	1¼	2¼
	5	5	5.750	1	4¼			5/16-24	4¾-12	3½-12	6.939	.610	1¼	2¼
8	3½	3½	4.250	1	3			¼-28	3¼-12	2½-12	5.252	.313	1¼	2¼
	4	4	4.750	1	3¾			5/16-24	3¾-12	3-12	5.939	.610	1¼	2¼
	4½	4½	5.250	1	3⅞			5/16-24	4¼-12	3¼-12	6.439	.610	1¼	2¼
	5	5	5.750	1	4¼			5/16-24	4¾-12	3½-12	6.939	.610	1¼	2¼
	5½	5½	6.250	1	4⅝			5/16-24	5¼-12	4-12	7.439	.610	1¼	2¼

Note: See page 6 for bore, rod, bolted/retainer bushing availability chart.

Add Stroke

ZB	ZT
6	7
6¾	7¾
6 ⁷ / ₁₆	7 ⁷ / ₈
6 ¹¹ / ₁₆	8½
6 ⁹ / ₁₆	7 ¹⁵ / ₁₆
6 ¹³ / ₁₆	8 ³ / ₁₆
7 ¹ / ₁₆	8 ⁷ / ₁₆
7 ¹¹ / ₁₆	9 ¹ / ₁₆
7 ¹⁵ / ₁₆	9 ¹¹ / ₁₆
8 ¹ / ₁₆	9 ¹³ / ₁₆
8 ³ / ₁₆	9 ¹⁵ / ₁₆
8 ⁵ / ₁₆	10 ¹ / ₁₆
8 ⁹ / ₁₆	10 ⁵ / ₁₆
9 ¹ / ₁₆	11 ¹ / ₁₆
9 ⁵ / ₁₆	11 ¹¹ / ₁₆
9 ⁹ / ₁₆	11 ¹⁵ / ₁₆
9 ¹³ / ₁₆	12¼
9 ¹⁵ / ₁₆	13¼
10 ¹ / ₁₆	13¼
10 ⁵ / ₁₆	13¼
10 ⁹ / ₁₆	13¼
11¾	14¾
11¾	14¾
11¾	14¾
11¾	14¾
13	16¼
13	16¼
13	16¼
13	16¼

Miller HV Series Hydraulic Cylinders

Rectangular Flange/Head End
1½" – 8" Bore Cylinders

Model 61-B (NFPA MF1) Bolted Bushing Rectangular Flange/Head End

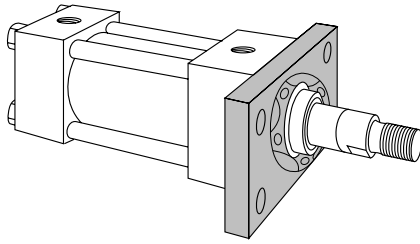

Note: High tensile mounting bolts should be used. Hardened flat washers should be used on 2½" through 8" bore cylinders.

Mounting Dimensions (see tables on opposite page)

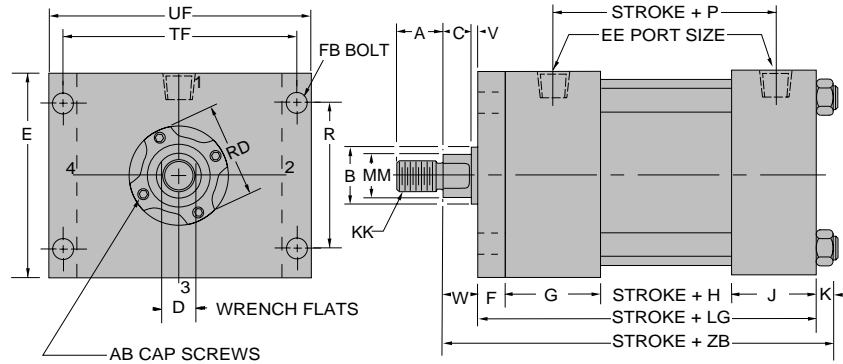

Model 61-R (NFPA MF1) Rectangular Retainer Rectangular Flange/Head End

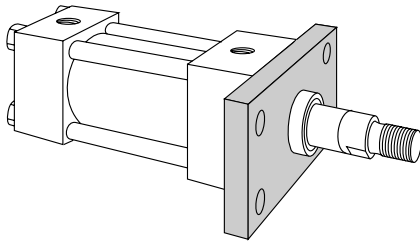

Note: High tensile mounting bolts should be used. Hardened flat washers should be used on 2½" through 8" bore cylinders.

Mounting Dimensions (see tables on opposite page)

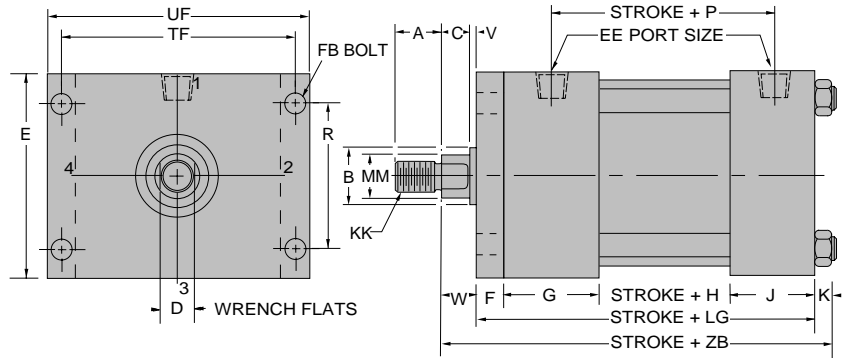

Note: To achieve higher pressure ratings in some size combinations retainer construction can be furnished in lieu of standard bolted bushing construction. -See pressure limitation chart for retainer held bushings on page 11.

Common Rod End Styles & Dimensions (See page 45 for complete listing of rod end styles)

Style No. 2-Standard Threaded on Turndown Section

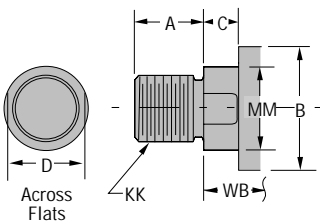

Style No. 4 Short Rod End-Internal Threads

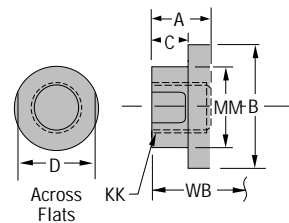

Style No. 5 Threaded Intermediate Male

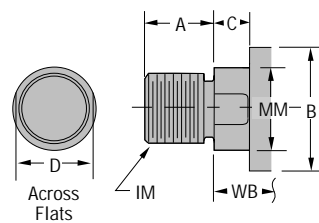

Style No. 6 Studded Rod End (Available Thru 2" Rod Diameter)

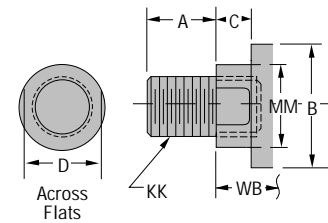

Pressure Limitations For Model 61-B

Rod Dia.	1"		1¾"		1¾"		2"		2½"		3"		3½"		4"		4½"		5"		5½"	
	Mod.	Sev.	Mod.	Sev.	Mod.	Sev.	Mod.	Sev.	Mod.	Sev.	Mod.	Sev.	Mod.	Sev.	Mod.	Sev.	Mod.	Sev.	Mod.	Sev.	Mod.	Sev.
2½	1560	940																				
3¼			1720	1030	1110	670																
4					1850	1110	1710	1030	1080	650												
5							1700	1020	1380	830	1100	660	810	490								
6									1580	950	1350	810	1130	680	820	490						
7											1240	740	1090	650	750	450	600	360	450	270		
8													1030	620	780	470	680	410	570	340	460	280

For higher rated Head End Mounted Cylinders, see Model HV-67 Mounting on page 18.

Miller HV Series Hydraulic Cylinders

Rectangular Flange/Head End 1 1/2" – 8" Bore Cylinders

Cylinder Body Dimensions

Bore Size	E	F	G	J	K	R	*EE		FB	TF	UF
							SAE	NPT			
1 1/2	2 1/2	3/8	1 3/4	1 1/2	3/8	1.63	-8	1/2	3/8	3 7/16	4 1/4
2	3	5/8	1 3/4	1 1/2	7/16	2.05	-8	1/2	1/2	4 1/8	5 1/8
2 1/2	3 1/2	5/8	1 3/4	1 1/2	7/16	2.55	-8	1/2	1/2	4 5/8	5 5/8
3 1/4	4 1/2	3/4	2	1 3/4	9/16	3.25	-12	3/4	5/8	5 7/8	7 1/8
4	5	7/8	2	1 3/4	9/16	3.82	-12	3/4	5/8	6 3/8	7 5/8
5	6 1/2	7/8	2	1 3/4	13/16	4.95	-12	3/4	7/8	8 3/16	9 3/4
6	7 1/2	1	2 1/4	2 1/4	15/16	5.73	-16	1	1	9 7/16	11 1/4
7	8 1/2	1	2 3/4	2 3/4	1	6.58	-20	1 1/4	1 1/8	10 5/8	12 5/8
8	9 1/2	1	3	3	1 1/4	7.50	-24	1 1/2	1 1/4	11 13/16	14

Add Stroke

H	LB	±LD	LG	P
1 3/8	4 5/8	4 7/8	5	2 7/8
1 3/8	4 5/8	4 7/8	5 1/4	2 7/8
1 1/2	4 3/4	5	5 3/8	3
1 3/4	5 1/2	5 3/4	6 1/4	3 1/2
2	5 3/4	6	6 5/8	3 3/4
2 1/2	6 1/4	6 1/2	7 1/8	4 1/4
2 7/8	7 3/8	7 3/8	8 3/8	4 7/8
3	8 1/2	8 1/2	9 1/2	5 3/8
3 1/2	9 1/2	9 1/2	10 1/2	6 1/8

*SAE ports are standard, NPT ports are available at no extra charge.
 †LD dimension is for double rod end models. See page 44.
 Note: Mounting holes are 1/16" larger than bolt sizes (FB) shown.

Rod End Dimensions

Bore Size	Rod Dia (MM)	A	B -.001 to -.003	C	D	V	W	AB	IM Style 5	KK Styles 2,4&6	RD (Max.)
1 1/2	5/8	3/4	1.125	3/8	1/2	1/4	5/8		1/2-20	7/16-20	
	1	1 1/8	1.500	1/2	7/8	1/2	1		7/8-14	3/4-16	
2	1	1 1/8	1.500	1/2	7/8	1/4	3/4		7/8-14	3/4-16	
	1 3/8	1 5/8	2.000	5/8	1 1/8	3/8	1		1 1/4-12	1-14	
2 1/2	1	1 1/8	1.500	1/2	7/8	1/4	3/4	1/4-28	7/8-14	3/4-16	2.472
	1 3/8	1 5/8	2.000	5/8	1 1/8	3/8	1		1 1/4-12	1-14	
	1 3/4	2	2.375	3/4	1 1/2	1/2	1 1/4		1 1/2-12	1 1/4-12	
3 1/4	1 3/8	1 5/8	2.000	5/8	1 1/8	1/4	7/8	1/4-28	1 1/4-12	1-14	2.972
	1 3/4	2	2.375	3/4	1 1/2	3/8	1 1/8	1/4-28	1 1/2-12	1 1/4-12	3.470
	2	2 1/4	2.625	7/8	1 11/16	3/8	1 1/4		1 3/4-12	1 1/2-12	
4	1 3/4	2	2.375	3/4	1 1/2	1/4	1	1/4-28	1 1/2-12	1 1/4-12	3.470
	2	2 1/4	2.625	7/8	1 11/16	1/4	1 1/8	1/4-28	1 3/4-12	1 1/2-12	3.720
	2 1/2	3	3.125	1	2 1/16	3/8	1 3/8	1/4-28	2 1/4-12	1 7/8-12	4.252
5	2	2 1/4	2.625	7/8	1 11/16	1/4	1 1/8	1/4-28	1 3/4-12	1 1/2-12	3.720
	2 1/2	3	3.125	1	2 1/16	3/8	1 3/8	1/4-28	2 1/4-12	1 7/8-12	4.252
	3	3 1/2	3.750	1	2 5/8	3/8	1 3/8	1/4-28	2 3/4-12	2 1/4-12	4.752
	3 1/2	3 1/2	4.250	1	3	3/8	1 3/8	1/4-28	3 1/4-12	2 1/2-12	5.252
6	2 1/2	3	3.125	1	2 1/16	1/4	1 1/4	1/4-28	2 1/4-12	1 7/8-12	4.252
	3	3 1/2	3.750	1	2 5/8	1/4	1 1/4	1/4-28	2 3/4-12	2 1/4-12	4.752
	3 1/2	3 1/2	4.250	1	3	1/4	1 1/4	1/4-28	3 1/4-12	2 1/2-12	5.252
	4	4	4.750	1	3 3/8	1/4	1 1/4	5/16-24	3 3/4-12	3-12	5.939
7	3	3 1/2	3.750	1	2 5/8	1/4	1 1/4	1/4-28	2 3/4-12	2 1/4-12	4.752
	3 1/2	3 1/2	4.250	1	3	1/4	1 1/4	1/4-28	3 1/4-12	2 1/2-12	5.252
	4	4	4.750	1	3 3/8	1/4	1 1/4	5/16-24	3 3/4-12	3-12	5.939
	4 1/2	4 1/2	5.250	1	3 7/8	1/4	1 1/4	5/16-24	4 1/4-12	3 1/4-12	6.439
	5	5	5.750	1	4 1/4	1/4	1 1/4	5/16-24	4 3/4-12	3 1/2-12	6.939
8	3 1/2	3 1/2	4.250	1	3	1/4	1 1/4	1/4-28	3 1/4-12	2 1/2-12	5.252
	4	4	4.750	1	3 3/8	1/4	1 1/4	5/16-24	3 3/4-12	3-12	5.939
	4 1/2	4 1/2	5.250	1	3 7/8	1/4	1 1/4	5/16-24	4 1/4-12	3 1/4-12	6.439
	5	5	5.750	1	4 1/4	1/4	1 1/4	5/16-24	4 3/4-12	3 1/2-12	6.939
	5 1/2	5 1/2	6.250	1	4 5/8	1/4	1 1/4	5/16-24	5 1/4-12	4-12	7.439

Add Stroke

ZB
6
6 3/8
6 1/16
6 1 1/16
6 9/16
6 13/16
7 1/16
7 1 1/16
7 5/16
8 1/16
8 3/16
8 5/16
8 9/16
9 1/16
9 5/16
9 9/16
10 9/16
10 9/16
10 9/16
11 3/4
11 3/4
11 3/4
11 3/4
13
13
13
13

Pressure Limitations For Model 61-R

Note: See page 6 for bore, rod, bolted/retainer bushing availability chart.

Rod Dia.	5/8"		1"		1 3/8"		1 3/4"		2"		2 1/2"		3"		3 1/2"		4"		4 1/2"		5"		5 1/2"	
	Mod.	Sev.	Mod.	Sev.	Mod.	Sev.	Mod.	Sev.	Mod.	Sev.	Mod.	Sev.	Mod.	Sev.	Mod.	Sev.	Mod.	Sev.	Mod.	Sev.	Mod.	Sev.	Mod.	Sev.
1 1/2	2480	1490	1740	1040																				
2			3610	2170	2220	1330																		
2 1/2			3560	2140	2670	1600	2000	1200																
3 1/4					3080	1850	2620	1570	2320	1390														
4							3240	1940	2960	1780	2400	1440												
5									2330	1400	2050	1230	1700	1020	1410	850								
6											2110	1270	1830	1100	1600	960	1380	830						
7													1240	740	1090	650	750	450	600	360	450	270		
8															1030	620	780	470	680	410	570	340	460	280

Miller HV Series Hydraulic Cylinders

Rectangular Flange/Cap End
1½" – 8" Bore Cylinders

Model 62-B (NFPA MF2)
Bolted Bushing
Rectangular Flange/Cap End

Mounting Dimensions
(see tables on opposite page)

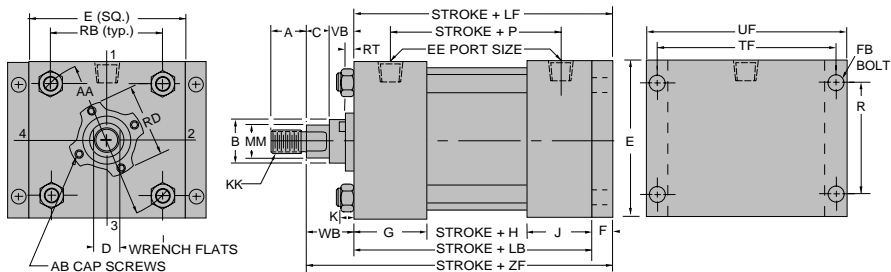
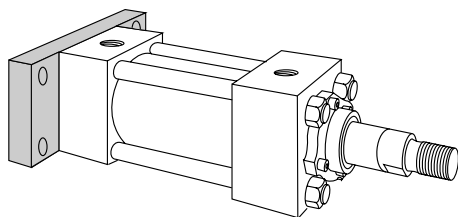

Note: High tensile mounting bolts should be used. Hardened flat washers should be used on 2½" through 8" bore cylinders.

Model 62-R (NFPA MF2)
Square Retainer
Rectangular Flange/Cap End

Mounting Dimensions
(see tables on opposite page)

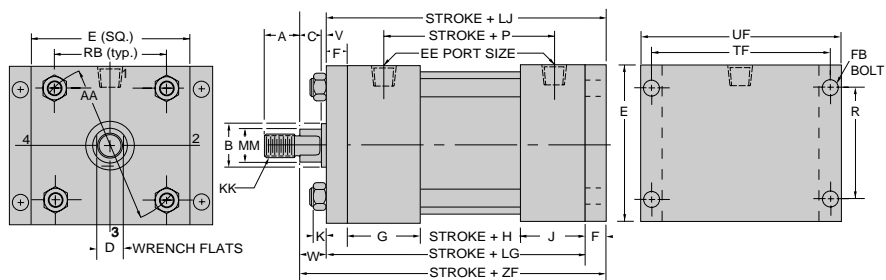
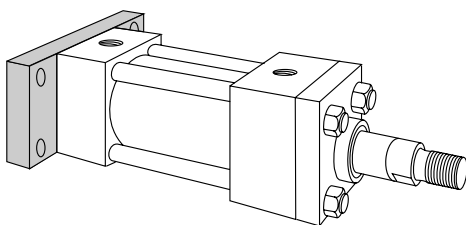

Note: High tensile mounting bolts should be used. Hardened flat washers should be used on 2½" through 8" bore cylinders.

Common Rod End Styles & Dimensions (See page 45 for complete listing of rod end styles)

Style No. 2-Standard
Threaded on Turndown Section

Style No. 4
Short Rod End-Internal Threads

Style No. 5
Threaded Intermediate Male

Style No. 6
Studded Rod End
(Available Thru 2" Rod Diameter)

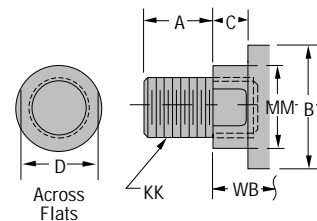
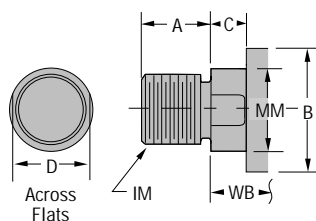
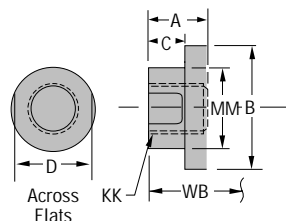
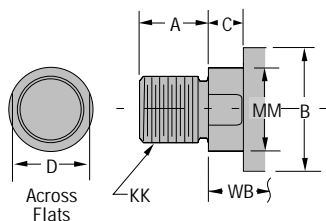

Pressure Limitations For Models 62-B and 62-R

Bore		1½	2	2½	3¼	4	5	6	7	8
Pressure	MOD.	2480	3610	3560	3080	3240	2330	2110	1240	1030
	SEVERE	1490	2170	2140	1850	1940	1400	1270	740	620

For higher rated cap end mounted cylinders, see Model HV-68 mounting on page 18.

Miller HV Series Hydraulic Cylinders

Rectangular Flange/Cap End
1 1/2" – 8" Bore Cylinders

Cylinder Body Dimensions

Bore Size	E	F	G	J	K	R	AA	*EE		FB	RB	TF	UF
								SAE	NPT				
1 1/2	2 1/2	3/8	1 3/4	1 1/2	3/8	1.63	2.3	-8	1/2	3/8	1.63	3 7/16	4 1/4
2	3	5/8	1 3/4	1 1/2	7/16	2.05	2.9	-8	1/2	1/2	2.05	4 1/8	5 1/8
2 1/2	3 1/2	5/8	1 3/4	1 1/2	7/16	2.55	3.6	-8	1/2	1/2	2.55	4 5/8	5 5/8
3 1/4	4 1/2	3/4	2	1 3/4	9/16	3.25	4.6	-12	3/4	5/8	3.25	5 7/8	7 1/8
4	5	7/8	2	1 3/4	9/16	3.82	5.4	-12	3/4	5/8	3.82	6 3/8	7 5/8
5	6 1/2	7/8	2	1 3/4	13/16	4.95	7.0	-12	3/4	7/8	4.95	8 3/16	9 3/4
6	7 1/2	1	2 1/4	2 1/4	15/16	5.73	8.1	-16	1	1	5.73	9 7/16	11 1/4
7	8 1/2	1	2 3/4	2 3/4	1	6.58	9.3	-20	1 1/4	1 1/8	6.58	10 5/8	12 5/8
8	9 1/2	1	3	3	1 1/4	7.50	10.6	-24	1 1/2	1 1/4	7.50	11 13/16	14

* SAE ports are standard, NPT ports are available at no extra charge.
Note: Mounting holes are 1/16" larger than bolt sizes (FB) shown.

Add Stroke

H	LB	±LD	LF	LG	LJ	P
1 3/8	4 5/8	4 7/8	5	5	5 3/8	2 7/8
1 3/8	4 5/8	4 7/8	5 1/4	5 1/4	5 7/8	2 7/8
1 1/2	4 3/4	5	5 3/8	5 3/8	6	3
1 3/4	5 1/2	5 3/4	6 1/4	6 1/4	7	3 1/2
2	5 3/4	6	6 5/8	6 5/8	7 1/2	3 3/4
2 1/2	6 1/4	6 1/2	7 1/8	7 1/8	8	4 1/4
2 7/8	7 3/8	7 3/8	8 3/8	8 3/8	9 3/8	4 7/8
3	8 1/2	8 1/2	9 1/2			5 3/8
3 1/2	9 1/2	9 1/2	10 1/2			6 1/8

Rod End Dimensions

Bore Size	Rod Dia (MM)	A	B -.001 to -.003	C	D	V	W	AB	IM Style 5	KK Styles 2,4&6	RD (Max.)	RT	VB	WB
1 1/2	5/8	3/4	1.125	3/8	1/2	1/4	5/8	10-32	1/2-20	7/16-20	1.972	.316	5/8	1
	1	1 1/8	1.500	1/2	7/8	1/2	1		7/8-14	3/4-16				
2	1	1 1/8	1.500	1/2	7/8	1/4	3/4	1/4-28	7/8-14	3/4-16	2.472	.328	7/8	1 3/8
	1 3/8	1 5/8	2.000	5/8	1 1/8	3/8	1		1 1/4-12	1-14				
2 1/2	1	1 1/8	1.500	1/2	7/8	1/4	3/4	1/4-28	7/8-14	3/4-16	2.472	.328	7/8	1 3/8
	1 3/8	1 5/8	2.000	5/8	1 1/8	3/8	1	1/4-28	1 1/4-12	1-14	2.972	.328	1	1 5/8
3 1/4	1 3/4	2	2.375	3/4	1 1/2	1/2	1 1/4	1/4-28	1 1/2-12	1 1/4-12	3.470	.313	1 1/8	1 7/8
	1 3/8	1 5/8	2.000	5/8	1 1/8	1/4	7/8	1/4-28	1 1/4-12	1-14	2.972	.328	1	1 5/8
4	1 3/4	2	2.375	3/4	1 1/2	1/4	1	1/4-28	1 1/2-12	1 1/4-12	3.470	.313	1 1/8	1 7/8
	2	2 1/4	2.625	7/8	1 11/16	3/8	1 1/4	1/4-28	1 3/4-12	1 1/2-12	3.720	.313	1 1/8	2
5	1 3/4	2	2.375	3/4	1 1/2	1/4	1	1/4-28	1 1/2-12	1 1/4-12	3.470	.313	1 1/8	1 7/8
	2 1/2	3	3.125	1	2 1/16	3/8	1 3/8	1/4-28	2 1/4-12	1 7/8-12	4.252	.313	1 1/4	2 1/4
6	2 1/2	3	3.125	1	2 1/16	3/8	1 3/8	1/4-28	2 1/4-12	1 7/8-12	4.252	.313	1 1/4	2 1/4
	3 1/2	3 1/2	4.250	1	3	3/8	1 3/8	1/4-28	3 1/4-12	2 1/2-12	5.252	.313	1 1/4	2 1/4
7	2 1/2	3	3.125	1	2 1/16	1/4	1 1/4	1/4-28	2 1/4-12	1 7/8-12	4.252	.313	1 1/4	2 1/4
	3	3 1/2	3.750	1	2 5/8	1/4	1 1/4	1/4-28	2 3/4-12	2 1/4-12	4.752	.313	1 1/4	2 1/4
8	3 1/2	3 1/2	4.250	1	3	1/4	1 1/4	1/4-28	3 1/4-12	2 1/2-12	5.252	.313	1 1/4	2 1/4
	4	4	4.750	1	3 3/8	1/4	1 1/4	5/16-24	3 3/4-12	3-12	5.939	.610	1 1/4	2 1/4
9	3	3 1/2	3.750	1	2 5/8			1/4-28	2 3/4-12	2 1/4-12	4.752	.313	1 1/4	2 1/4
	3 1/2	3 1/2	4.250	1	3			1/4-28	3 1/4-12	2 1/2-12	5.252	.313	1 1/4	2 1/4
10	4	4	4.750	1	3 3/8			5/16-24	3 3/4-12	3-12	5.939	.610	1 1/4	2 1/4
	4 1/2	4 1/2	5.250	1	3 7/8			5/16-24	4 1/4-12	3 1/2-12	6.439	.610	1 1/4	2 1/4
11	5	5	5.750	1	4 1/4			5/16-24	4 3/4-12	3 1/2-12	6.939	.610	1 1/4	2 1/4
	3 1/2	3 1/2	4.250	1	3			1/4-28	3 1/4-12	2 1/2-12	5.252	.313	1 1/4	2 1/4
12	4	4	4.750	1	3 3/8			5/16-24	3 3/4-12	3-12	5.939	.610	1 1/4	2 1/4
	4 1/2	4 1/2	5.250	1	3 7/8			5/16-24	4 1/4-12	3 1/2-12	6.439	.610	1 1/4	2 1/4
13	5	5	5.750	1	4 1/4			5/16-24	4 3/4-12	3 1/2-12	6.939	.610	1 1/4	2 1/4
	5 1/2	5 1/2	6.250	1	4 5/8			5/16-24	5 1/4-12	4-12	7.439	.610	1 1/4	2 1/4

Add Stroke

ZF
6
6 3/8
6 5/8
6 7/8
6 3/4
7
7 1/4
7 7/8
8 1/8
8 1/4
8 1/2
8 5/8
8 7/8
9 1/8
9 3/8
9 3/8
10 5/8
10 5/8
10 5/8
10 5/8
11 3/4
11 3/4
11 3/4
11 3/4
12 3/4
12 3/4
12 3/4
12 3/4

Note: See page 6 for bore, rod, bolted/retainer bushing availability chart.

Miller HV Series Hydraulic Cylinders

Square Flange/Head End
1½"–8" Bore Cylinders

Model 65-B (NFPA MF5)
Bolted Bushing
Square Flange/Head End

Mounting Dimensions
(See tables on opposite page)

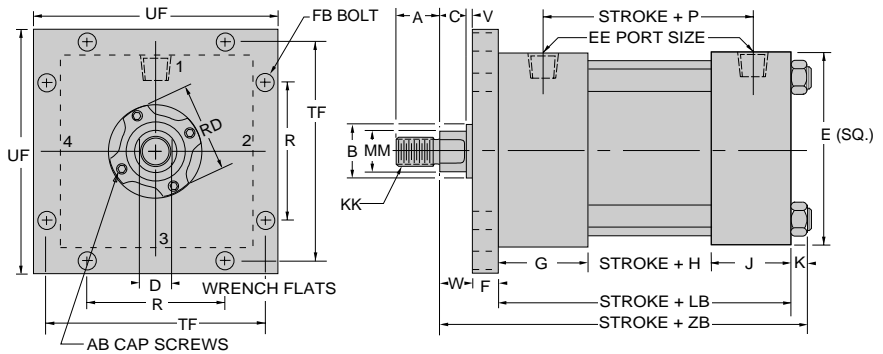
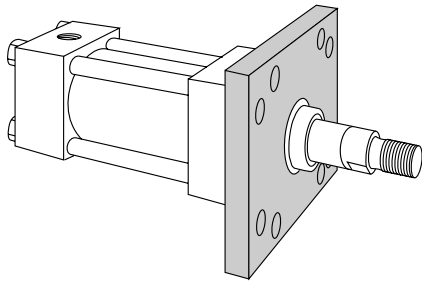

Note: High tensile mounting bolts should be used. Hardened flat washers should be used on 2½" through 8" bore cylinders.

Model 65-R (NFPA MF5)
Square Retainer Held Bushing
Square Flange/Head End

Mounting Dimensions
(See tables on opposite page)

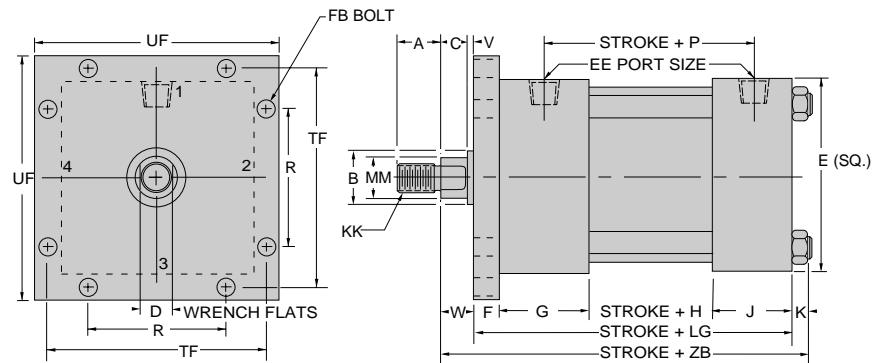
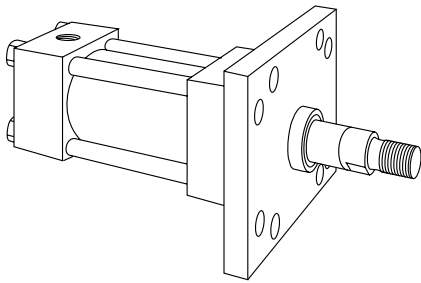

Note: High tensile mounting bolts should be used. Hardened flat washers should be used on 2½" through 8" bore cylinders.

Common Rod End Styles & Dimensions (See page 45 for complete listing of rod end styles)

Style No. 2-Standard
Threaded on Turndown Section

Style No. 4
Short Rod End-Internal Threads

Style No. 5
Threaded Intermediate Male

Style No. 6
Studded Rod End
(Available Thru 2" Rod Diameter)

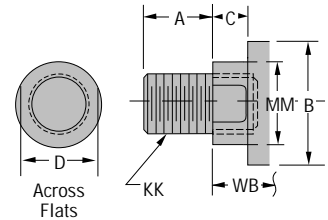
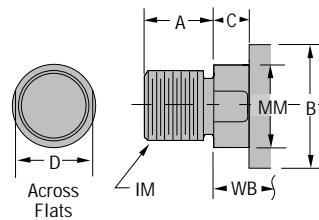
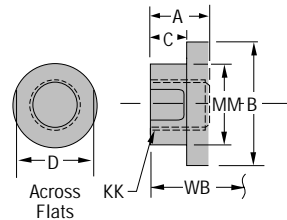
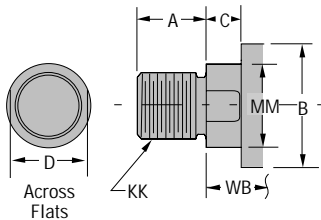

Pressure Limitations For Model 65-B and 65-R

Rod Dia.	1¾"		2"		2½"		3"		3½"		4"		4½"		5"		5½"		
Bore Sizes	Mod.	Sev.	Mod.	Sev.	Mod.	Sev.	Mod.	Sev.	Mod.	Sev.	Mod.	Sev.	Mod.	Sev.	Mod.	Sev.	Mod.	Sev.	
4	4000	2400	4000	2400	4000	2400													
5			4000	2400	4000	2400	3780	2270	3230	1940									
6					3000	1800	3000	1800	3000	1800	3000	1800							
7							3000	1800	3000	1800	2580	1550	2280	1370	1980	1190			
8									2890	1730	2400	1440	2180	1310	1970	1180	1750	1050	

Miller HV Series Hydraulic Cylinders

Square Flange/Head End 1 1/2" – 8" Bore Cylinders

Cylinder Body Dimensions

Bore Size	E	F	G	J	K	R	*EE		FB	TF	UF
							SAE	NPT			
1 1/2	2 1/2	3/8	1 3/4	1 1/2	3/8	1.63	-8	1/2	3/8	3 7/16	4 1/4
2	3	5/8	1 3/4	1 1/2	7/16	2.05	-8	1/2	1/2	4 1/8	5 1/8
2 1/2	3 1/2	5/8	1 3/4	1 1/2	7/16	2.55	-8	1/2	1/2	4 5/8	5 5/8
3 1/4	4 1/2	3/4	2	1 3/4	9/16	3.25	-12	3/4	5/8	5 7/8	7 1/8
4	5	7/8	2	1 3/4	9/16	3.82	-12	3/4	5/8	6 3/8	7 5/8
5	6 1/2	7/8	2	1 3/4	13/16	4.95	-12	3/4	7/8	8 3/16	9 3/4
6	7 1/2	1	2 1/4	2 1/4	15/16	5.73	-16	1	1	9 7/16	11 1/4
7	8 1/2	1	2 3/4	2 3/4	1	6.58	-20	1 1/4	1 1/8	10 5/8	12 5/8
8	9 1/2	1	3	3	1 1/4	7.50	-24	1 1/2	1 1/4	11 13/16	14

* SAE ports are standard, NPT ports are available at no extra charge.

† LD dimension is for double rod end models. See page 44.

Note: Mounting holes are 1/16" larger than bolt sizes (FB) shown.

Add Stroke

H	LB	±LD	LG	P
1 3/8	4 5/8	4 7/8	5	2 7/8
1 3/8	4 5/8	4 7/8	5 1/4	2 7/8
1 1/2	4 3/4	5	5 3/8	3
1 3/4	5 1/2	5 3/4	6 1/4	3 1/2
2	5 3/4	6	6 5/8	3 3/4
2 1/2	6 1/4	6 1/2	7 1/8	4 1/4
2 7/8	7 3/8	7 3/8	8 3/8	4 7/8
3	8 1/2	8 1/2	9 1/2	5 3/8
3 1/2	9 1/2	9 1/2	10 1/2	6 1/8

Rod End Dimensions

Bore Size	Rod Dia (MM)	A	B -.001 to -.003	C	D	V	W	AB	IM Style 5	KK Styles 2,4&6	RD (Max.)
1 1/2	5/8	3/4	1.125	3/8	1/2	1/4	5/8		1/2-20	7/16-20	
	1	1 1/8	1.500	1/2	7/8	1/2	1		7/8-14	3/4-16	
2	1	1 1/8	1.500	1/2	7/8	1/4	3/4		7/8-14	3/4-16	
	1 3/8	1 5/8	2.000	5/8	1 1/8	3/8	1		1 1/4-12	1-14	
2 1/2	1	1 1/8	1.500	1/2	7/8	1/4	3/4	1/4-28	7/8-14	3/4-16	2.472
	1 3/8	1 5/8	2.000	5/8	1 1/8	3/8	1		1 1/4-12	1-14	
	1 3/4	2	2.375	3/4	1 1/2	1/2	1 1/4		1 1/2-12	1 1/4-12	
3 1/4	1 3/8	1 5/8	2.000	5/8	1 1/8	1/4	7/8	1/4-28	1 1/4-12	1-14	2.972
	1 3/4	2	2.375	3/4	1 1/2	3/8	1 1/8	1/4-28	1 1/2-12	1 1/4-12	3.470
	2	2 1/4	2.625	7/8	1 11/16	3/8	1 1/4		1 3/4-12	1 1/2-12	
4	1 3/4	2	2.375	3/4	1 1/2	1/4	1	1/4-28	1 1/2-12	1 1/4-12	3.470
	2	2 1/4	2.625	7/8	1 11/16	1/4	1 1/8	1/4-28	1 3/4-12	1 1/2-12	3.720
	2 1/2	3	3.125	1	2 1/16	3/8	1 3/8	1/4-28	2 1/4-12	1 7/8-12	4.252
5	2	2 1/4	2.625	7/8	1 11/16	1/4	1 1/8	1/4-28	1 3/4-12	1 1/2-12	3.720
	2 1/2	3	3.125	1	2 1/16	3/8	1 3/8	1/4-28	2 1/4-12	1 7/8-12	4.252
	3	3 1/2	3.750	1	2 5/8	3/8	1 3/8	1/4-28	2 3/4-12	2 1/4-12	4.752
	3 1/2	3 1/2	4.250	1	3	3/8	1 3/8	1/4-28	3 1/4-12	2 1/2-12	5.252
6	2 1/2	3	3.125	1	2 1/16	1/4	1 1/4	1/4-28	2 1/4-12	1 7/8-12	4.252
	3	3 1/2	3.750	1	2 5/8	1/4	1 1/4	1/4-28	2 3/4-12	2 1/4-12	4.752
	3 1/2	3 1/2	4.250	1	3	1/4	1 1/4	1/4-28	3 1/4-12	2 1/2-12	5.252
	4	4	4.750	1	3 3/8	1/4	1 1/4	5/16-24	3 3/4-12	3-12	5.939
7	3	3 1/2	3.750	1	2 5/8	1/4	1 1/4	1/4-28	2 3/4-12	2 1/4-12	4.752
	3 1/2	3 1/2	4.250	1	3	1/4	1 1/4	1/4-28	3 1/4-12	2 1/2-12	5.252
	4	4	4.750	1	3 3/8	1/4	1 1/4	5/16-24	3 3/4-12	3-12	5.939
	4 1/2	4 1/2	5.250	1	3 7/8	1/4	1 1/4	5/16-24	4 1/4-12	3 1/4-12	6.439
	5	5	5.750	1	4 1/4	1/4	1 1/4	5/16-24	4 3/4-12	3 1/2-12	6.939
8	3 1/2	3 1/2	4.250	1	3	1/4	1 1/4	1/4-28	3 1/4-12	2 1/2-12	5.252
	4	4	4.750	1	3 3/8	1/4	1 1/4	5/16-24	3 3/4-12	3-12	5.939
	4 1/2	4 1/2	5.250	1	3 7/8	1/4	1 1/4	5/16-24	4 1/4-12	3 1/4-12	6.439
	5	5	5.750	1	4 1/4	1/4	1 1/4	5/16-24	4 3/4-12	3 1/2-12	6.939
	5 1/2	5 1/2	6.250	1	4 5/8	1/4	1 1/4	5/16-24	5 1/4-12	4-12	7.439

Add Stroke

ZB
6
6 3/8
6 7/16
6 11/16
6 9/16
6 13/16
7 1/16
7 11/16
7 15/16
8 1/16
8 3/16
8 5/16
8 9/16
9 1/16
9 5/16
9 9/16
10 9/16
10 13/16
10 17/16
10 21/16
11 3/4
11 7/8
11 11/8
11 15/8
12 1/8
12 5/8
12 9/8
12 13/8
12 17/8
13
13 1/4
13 1/2
13 3/4
13 1/2
14

Note: See page 6 for bore, rod, bolted/retainer bushing availability chart.

Miller HV Series Hydraulic Cylinders

Square Flange/Cap End
1½" – 8" Bore Cylinders

Model 66-B (NFPA MF6)
Bolted Bushing
Square Flange/Cap End

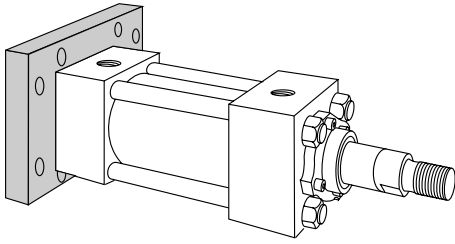

Mounting Dimensions
(See tables on opposite page)

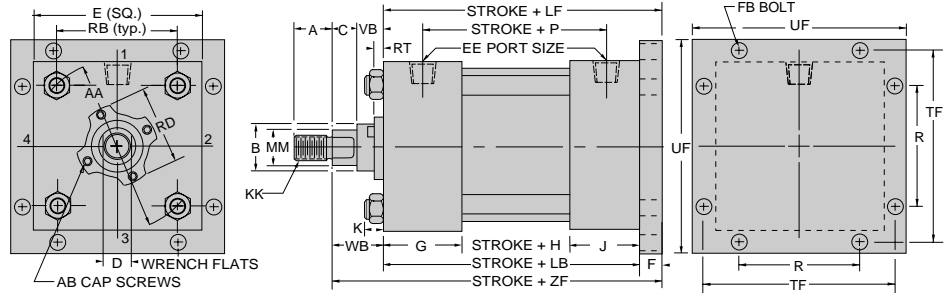

Note: High tensile mounting bolts should be used. Hardened flat washers should be used on 2½" through 8" bore cylinders.

Model 66-R (NFPA MF6)
Square Retainer Held Bushing
Square Flange/Cap End

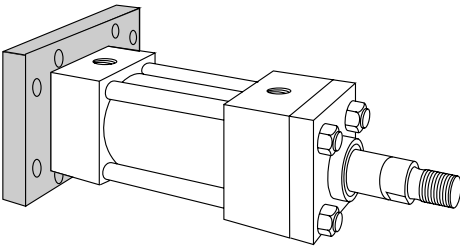

Mounting Dimensions
(See tables on opposite page)

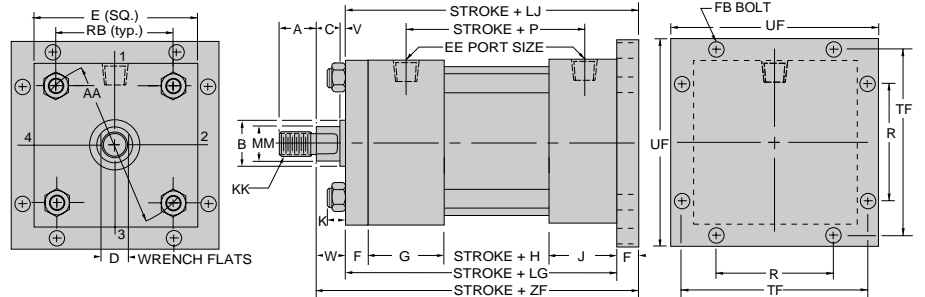

Note: High tensile mounting bolts should be used. Hardened flat washers should be used on 2½" through 8" bore cylinders.

Common Rod End Styles & Dimensions (See page 45 for complete listing of rod end styles)

Style No. 2-Standard
Threaded on Turndown Section

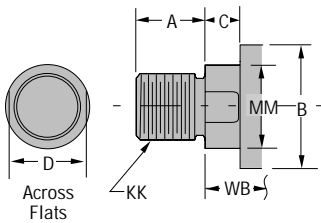

Style No. 4
Short Rod End-Internal Threads

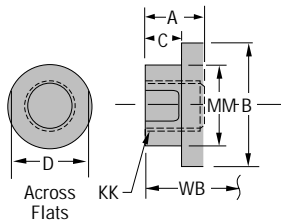

Style No. 5
Threaded Intermediate Male

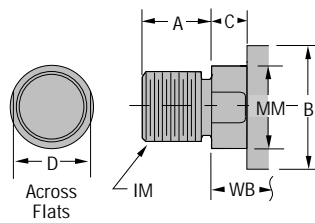

Style No. 6
Studded Rod End
(Available Thru 2" Rod Diameter)

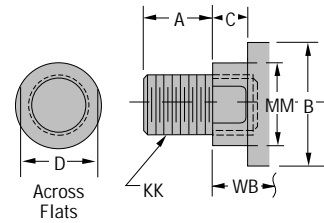

Pressure Limitations For Model 66-B and 66-R

Bore		4	5	6	7	8
Pressure	MOD.	4000	4000	3000	3000	2890
	SEVERE	2400	2400	1800	1800	1730

Miller HV Series Hydraulic Cylinders

Square Flange/Cap End
1½" – 8" Bore Cylinders

Cylinder Body Dimensions

Bore Size	E	F	G	J	K	R	AA	*EE		FB	RB	TF	UF
								SAE	NPT				
1½	2½	¾	1¾	1½	¾	1.63	2.3	-8	½	¾	1.63	37/16	4¼
2	3	5/8	1¾	1½	7/16	2.05	2.9	-8	½	½	2.05	4½	5½
2½	3½	5/8	1¾	1½	7/16	2.55	3.6	-8	½	½	2.55	45/8	55/8
3¼	4½	¾	2	1¾	9/16	3.25	4.6	-12	¾	5/8	3.25	57/8	71/8
4	5	7/8	2	1¾	9/16	3.82	5.4	-12	¾	5/8	3.82	63/8	75/8
5	6½	7/8	2	1¾	13/16	4.95	7.0	-12	¾	7/8	4.95	83/16	9¾
6	7½	1	2¼	2¼	15/16	5.73	8.1	-16	1	1	5.73	97/16	11¼
7	8½	1	2¾	2¾	1	6.58	9.3	-20	1¼	1½	6.58	105/8	125/8
8	9½	1	3	3	1¼	7.50	10.6	-24	1½	1¼	7.50	1113/16	14

* SAE ports are standard, NPT ports are available at no extra charge.
Note: Mounting holes are 1/16" larger than bolt sizes (FB) shown.

Add Stroke

H	LB	LF	LG	P	LJ
1¾	45/8	5	5	27/8	53/8
1¾	45/8	5¼	5¼	27/8	57/8
1½	4¾	53/8	53/8	3	6
1¾	5½	6¼	6¼	3½	7
2	5¾	65/8	65/8	3¾	7½
2½	6¼	7½	7½	4¼	8
27/8	73/8	83/8	83/8	47/8	93/8
3	8½	9½		53/8	
3½	9½	10½		6½	

Rod End Dimensions

Bore Size	Rod Dia (MM)	A	B -.001 to -.003	C	D	V	W	AB	IM Style 5	KK Styles 2,4&6	RD (Max.)	RT	VB	WB
1½	5/8	¾	1.125	¾	½	¼	5/8	10-32	½-20	7/16-20	1.972	.316	5/8	1
	1	17/8	1.500	½	7/8	½	1		7/8-14	¾-16				
2	1	17/8	1.500	½	7/8	¼	¾	¼-28	7/8-14	¾-16	2.472	.328	7/8	13/8
	13/8	15/8	2.000	5/8	11/8	¾	1		1¼-12	1-14				
2½	1	17/8	1.500	½	7/8	¼	¾	¼-28	7/8-14	¾-16	2.472	.328	7/8	13/8
	13/8	15/8	2.000	5/8	11/8	¾	1	¼-28	1¼-12	1-14	2.972	.328	1	15/8
	1¾	2	2.375	¾	1½	½	1¼	¼-28	1½-12	1¼-12	3.470	.313	1½	17/8
3¼	13/8	15/8	2.000	5/8	11/8	¼	7/8	¼-28	1¼-12	1-14	2.972	.328	1	15/8
	1¾	2	2.375	¾	1½	¾	11/8	¼-28	1½-12	1¼-12	3.470	.313	11/8	17/8
	2	2¼	2.625	7/8	111/16	¾	1¼	¼-28	1¾-12	1½-12	3.720	.313	11/8	2
4	1¾	2	2.375	¾	1½	¼	1	¼-28	1½-12	1¼-12	3.470	.313	11/8	17/8
	2	2¼	2.625	7/8	111/16	¼	11/8	¼-28	1¾-12	1½-12	3.720	.313	11/8	2
	2½	3	3.125	1	21/16	¾	13/8	¼-28	2¼-12	17/8-12	4.252	.313	1¼	2¼
5	2	2¼	2.625	7/8	111/16	¼	11/8	¼-28	1¾-12	1½-12	3.720	.313	11/8	2
	2½	3	3.125	1	21/16	¾	13/8	¼-28	2¼-12	17/8-12	4.252	.313	1¼	2¼
	3	3½	3.750	1	25/8	¾	13/8	¼-28	2¾-12	2¼-12	4.752	.313	1¼	2¼
	3½	3½	4.250	1	3	¾	13/8	¼-28	3¼-12	2½-12	5.252	.313	1¼	2¼
6	2½	3	3.125	1	21/16	¼	1¼	¼-28	2¼-12	17/8-12	4.252	.313	1¼	2¼
	3	3½	3.750	1	25/8	¼	1¼	¼-28	2¾-12	2¼-12	4.752	.313	1¼	2¼
	3½	3½	4.250	1	3	¼	1¼	¼-28	3¼-12	2½-12	5.252	.313	1¼	2¼
	4	4	4.750	1	33/8	¼	1¼	5/16-24	3¾-12	3-12	5.939	.610	1¼	2¼
7	3	3½	3.750	1	25/8			¼-28	2¾-12	2¼-12	4.752	.313	1¼	2¼
	3½	3½	4.250	1	3			¼-28	3¼-12	2½-12	5.252	.313	1¼	2¼
	4	4	4.750	1	33/8			5/16-24	3¾-12	3-12	5.939	.610	1¼	2¼
	4½	4½	5.250	1	37/8			5/16-24	4¼-12	3¼-12	6.439	.610	1¼	2¼
	5	5	5.750	1	4¼			5/16-24	4¾-12	3½-12	6.939	.610	1¼	2¼
8	3½	3½	4.250	1	3			¼-28	3¼-12	2½-12	5.252	.313	1¼	2¼
	4	4	4.750	1	33/8			5/16-24	3¾-12	3-12	5.939	.610	1¼	2¼
	4½	4½	5.250	1	37/8			5/16-24	4¼-12	3¼-12	6.439	.610	1¼	2¼
	5	5	5.750	1	4¼			5/16-24	4¾-12	3½-12	6.939	.610	1¼	2¼
	5½	5½	6.250	1	45/8			5/16-24	5¼-12	4-12	7.439	.610	1¼	2¼

Note: See page 6 for bore, rod, bolted/retainer bushing availability chart.

Add Stroke

ZF
6
63/8
65/8
67/8
6¾
7
7¼
77/8
81/8
8¼
8½
85/8
87/8
91/8
93/8
93/8
93/8
105/8
105/8
105/8
105/8
113/4
113/4
113/4
113/4
113/4
123/4
123/4
123/4
123/4
123/4

Miller HV Series Hydraulic Cylinders

Rectangular Head/Cap
1½" – 8" Bore Cylinders

Model 67-B (NFPA ME5)
Bolted Bushing
Rectangular Head

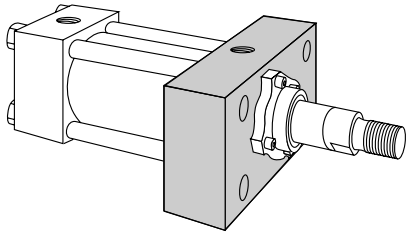

Mounting Dimensions
(See tables on opposite page)

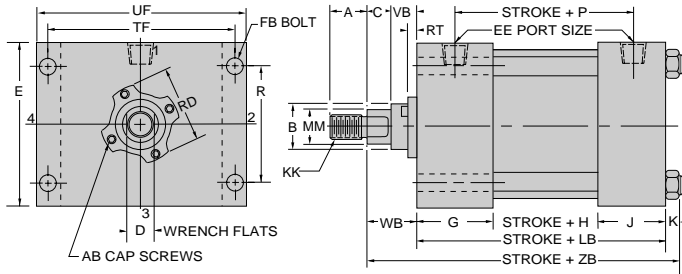

Note: High tensile mounting bolts should be used. Hardened flat washers should be used on 2½" through 8" bore cylinders. Not available in Retainer Held Bushing construction.

Model 68-B (NFPA ME6)
Bolted Bushing
Rectangular Cap

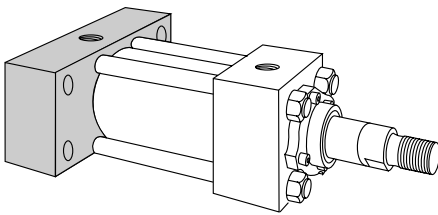

Mounting Dimensions
(See tables on opposite page)

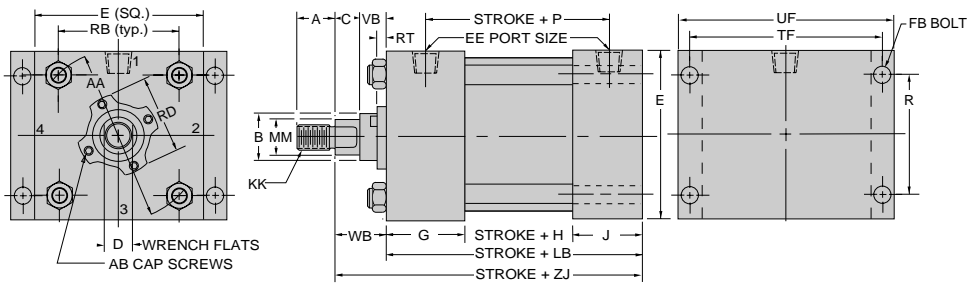

Note: High tensile mounting bolts should be used. Hardened flat washers should be used on 2½" through 8" bore cylinders.

Model 68-R (NFPA ME6)
Square Retainer Held Bushing
Rectangular Cap End

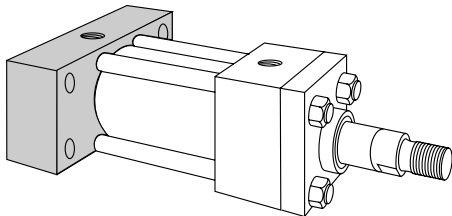

Mounting Dimensions
(See tables on opposite page)

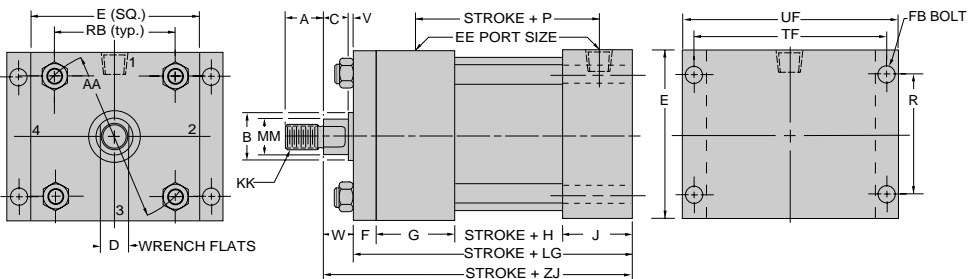

See Page 45 for Rod End Styles.

Note: High tensile mounting bolts should be used. Hardened flat washers should be used on 2½" through 8" bore cylinders.

Common Rod End Styles & Dimensions (See page 45 for complete listing of rod end styles)

Style No. 2-Standard
Threaded on Turndown Section

Style No. 4
Short Rod End-Internal Threads

Style No. 5
Threaded Intermediate Male

Style No. 6
Studded Rod End
(Available Thru 2" Rod Diameter)

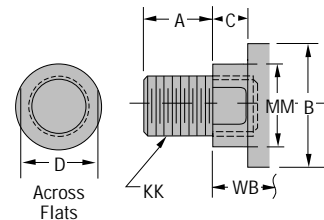
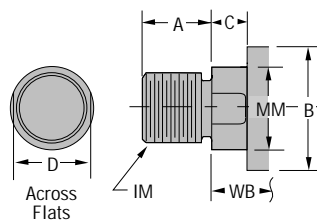
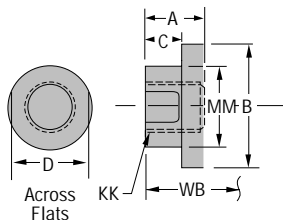
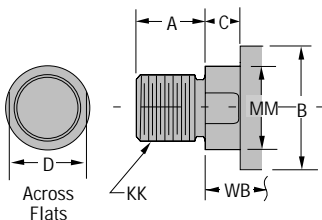

Miller HV Series Hydraulic Cylinders

Rectangular Head/Cap 1 1/2" - 8" Bore Cylinders

Cylinder Body Dimensions

Bore Size	E	F	G	J	K	R	AA	*EE		FB	RB	TF	UF
								SAE	NPT				
1 1/2	2 1/2	3/8	1 3/4	1 1/2	3/8	1.63	2.3	-8	1/2	3/8	1.63	3 7/16	4 1/4
2	3	5/8	1 3/4	1 1/2	7/16	2.05	2.9	-8	1/2	1/2	2.05	4 1/8	5 1/8
2 1/2	3 1/2	5/8	1 3/4	1 1/2	7/16	2.55	3.6	-8	1/2	1/2	2.55	4 5/8	5 5/8
3 1/4	4 1/2	3/4	2	1 3/4	9/16	3.25	4.6	-12	3/4	5/8	3.25	5 7/8	7 1/8
4	5	7/8	2	1 3/4	9/16	3.82	5.4	-12	3/4	5/8	3.82	6 3/8	7 5/8
5	6 1/2	7/8	2	1 3/4	13/16	4.95	7.0	-12	3/4	7/8	4.95	8 3/16	9 3/4
6	7 1/2	1	2 1/4	2 1/4	15/16	5.73	8.1	-16	1	1	5.73	9 7/16	11 1/4
7	8 1/2		2 3/4	2 3/4	1	6.58	9.3	-20	1 1/4	1 1/8	6.58	10 5/8	12 5/8
8	9 1/2		3	3	1 1/4	7.50	10.6	-24	1 1/2	1 1/4	7.50	11 13/16	14

Add Stroke

H	LB	‡LD	LG	P
1 3/8	4 5/8	4 7/8	5	2 7/8
1 3/8	4 5/8	4 7/8	5 1/4	2 7/8
1 1/2	4 3/4	5	5 3/8	3
1 3/4	5 1/2	5 3/4	6 1/4	3 1/2
2	5 3/4	6	6 5/8	3 3/4
2 1/2	6 1/4	6 1/2	7 1/8	4 1/4
2 7/8	7 3/8	7 3/8	8 3/8	4 7/8
3	8 1/2	8 1/2		5 3/8
3 1/2	9 1/2	9 1/2		6 1/8

* SAE ports are standard, NPT ports are available at no extra charge. ‡LD dimension is for double rod end models. See page 44.
Note: Mounting holes are 1/16" larger than bolt sizes (FB) shown.

Rod End Dimensions

Bore Size	Rod Dia (MM)	A	B -.001 to -.003	C	D	V	W	AB	IM Style 5	KK Styles 2,4&6	RD (Max.)	RT	VB	WB
	1	1 1/8	1.500	1/2	7/8	1/2	1	1/4-28	7/8-14	3/4-16	2.472	.328	7/8	1 3/8
2	1	1 1/8	1.500	1/2	7/8	1/4	3/4	1/4-28	7/8-14	3/4-16	2.472	.328	7/8	1 3/8
	1 3/8	1 5/8	2.000	5/8	1 1/8	3/8	1	1/4-28	1 1/4-12	1-14	2.972	.328	1	1 5/8
2 1/2	1	1 1/8	1.500	1/2	7/8	1/4	3/4	1/4-28	7/8-14	3/4-16	2.472	.328	7/8	1 3/8
	1 3/8	1 5/8	2.000	5/8	1 1/8	3/8	1	1/4-28	1 1/4-12	1-14	2.972	.328	1	1 5/8
	1 3/4	2	2.375	3/4	1 1/2	1/2	1 1/4	1/4-28	1 1/2-12	1 1/4-12	3.470	.313	1 1/8	1 7/8
3 1/4	1 3/8	1 5/8	2.000	5/8	1 1/8	1/4	7/8	1/4-28	1 1/4-12	1-14	2.972	.328	1	1 5/8
	1 3/4	2	2.375	3/4	1 1/2	3/8	1 1/8	1/4-28	1 1/2-12	1 1/4-12	3.470	.313	1 1/8	1 7/8
	2	2 1/4	2.625	7/8	1 11/16	3/8	1 1/4	1/4-28	1 3/4-12	1 1/2-12	3.720	.313	1 1/8	2
4	1 3/4	2	2.375	3/4	1 1/2	1/4	1	1/4-28	1 1/2-12	1 1/4-12	3.470	.313	1 1/8	1 7/8
	2	2 1/4	2.625	7/8	1 11/16	1/4	1 1/8	1/4-28	1 3/4-12	1 1/2-12	3.720	.313	1 1/8	2
	2 1/2	3	3.125	1	2 1/16	3/8	1 3/8	1/4-28	2 1/4-12	1 7/8-12	4.252	.313	1 1/4	2 1/4
5	2	2 1/4	2.625	7/8	1 11/16	1/4	1 1/8	1/4-28	1 3/4-12	1 1/2-12	3.720	.313	1 1/8	2
	2 1/2	3	3.125	1	2 1/16	3/8	1 3/8	1/4-28	2 1/4-12	1 7/8-12	4.252	.313	1 1/4	2 1/4
	3	3 1/2	3.750	1	2 5/8	3/8	1 3/8	1/4-28	2 3/4-12	2 1/4-12	4.752	.313	1 1/4	2 1/4
	3 1/2	3 1/2	4.250	1	3	3/8	1 3/8	1/4-28	3 1/4-12	2 1/2-12	5.252	.313	1 1/4	2 1/4
6	2 1/2	3	3.125	1	2 1/16	1/4	1 1/4	1/4-28	2 1/4-12	1 7/8-12	4.252	.313	1 1/4	2 1/4
	3	3 1/2	3.750	1	2 5/8	1/4	1 1/4	1/4-28	2 3/4-12	2 1/4-12	4.752	.313	1 1/4	2 1/4
	3 1/2	3 1/2	4.250	1	3	1/4	1 1/4	1/4-28	3 1/4-12	2 1/2-12	5.252	.313	1 1/4	2 1/4
	4	4	4.750	1	3 3/8	1/4	1 1/4	5/16-24	3 3/4-12	3-12	5.939	.610	1 1/4	2 1/4
7	3	3 1/2	3.750	1	2 5/8			1/4-28	2 3/4-12	2 1/4-12	4.752	.313	1 1/4	2 1/4
	3 1/2	3 1/2	4.250	1	3			1/4-28	3 1/4-12	2 1/2-12	5.252	.313	1 1/4	2 1/4
	4	4	4.750	1	3 3/8			5/16-24	3 3/4-12	3-12	5.939	.610	1 1/4	2 1/4
	4 1/2	4 1/2	5.250	1	3 7/8			5/16-24	4 1/4-12	3 1/4-12	6.439	.610	1 1/4	2 1/4
	5	5	5.750	1	4 1/4			5/16-24	4 3/4-12	3 1/2-12	6.939	.610	1 1/4	2 1/4
8	3 1/2	3 1/2	4.250	1	3			1/4-28	3 1/4-12	2 1/2-12	5.252	.313	1 1/4	2 1/4
	4	4	4.750	1	3 3/8			5/16-24	3 3/4-12	3-12	5.939	.610	1 1/4	2 1/4
	4 1/2	4 1/2	5.250	1	3 7/8			5/16-24	4 1/4-12	3 1/4-12	6.439	.610	1 1/4	2 1/4
	5	5	5.750	1	4 1/4			5/16-24	4 3/4-12	3 1/2-12	6.939	.610	1 1/4	2 1/4
	5 1/2	5 1/2	6.250	1	4 5/8			5/16-24	5 1/4-12	4-12	7.439	.610	1 1/4	2 1/4

Note: See page 6 for bore, rod, bolted/retainer bushing availability chart.

** 1 1/2" bore with 1" rod dia. and 2" bore with 1 3/8" rod dia. not available with bolted bushing on Model 68.

Add Stroke

ZB	ZJ
6	5 5/8
6 3/8	6
6 7/16	6
6 11/16	6 1/4
6 9/16	6 1/8
6 13/16	6 3/8
7 1/16	6 5/8
7 11/16	7 1/8
7 15/16	7 3/8
8 1/16	7 1/2
8 3/16	7 5/8
8 5/16	7 3/4
8 9/16	8
9 1/16	8 1/4
9 5/16	8 1/2
9 9/16	8 1/2
9 13/16	8 3/4
10 1/16	9 1/8
10 5/16	9 1/8
10 9/16	9 1/8
10 13/16	9 5/8
11 1/4	10 3/4
11 1/8	10 3/4
11 3/8	10 3/4
11 5/8	10 3/4
11 7/8	10 3/4
12	11 3/4
12 1/8	11 3/4
12 3/8	11 3/4
12 5/8	11 3/4
12 7/8	11 3/4
13	11 3/4
13 1/8	11 3/4
13 1/4	11 3/4
13 1/2	11 3/4
13 3/4	11 3/4

Miller HV Series Hydraulic Cylinders

Side Lug
1½"–8" Bore Cylinders

Model 72-B (NFPA MS2)
Bolted Bushing
Side Lug

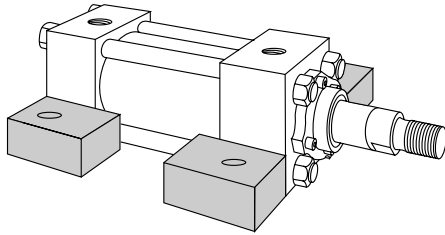

Mounting Dimensions
(See tables on opposite page)

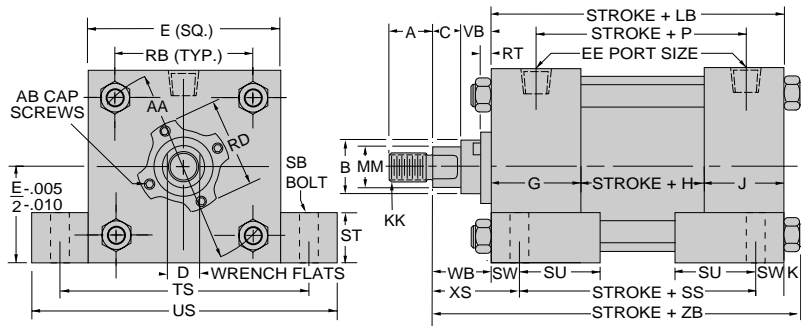

Note: Lugs should be blocked, or a "K" retainer should be mounted on the appropriate end to absorb hydraulic or mechanical shock. Bolts should not carry shear load. See Page 64

Model 72-R (NFPA MS2)
Square Retainer Held Bushing
Side Lug

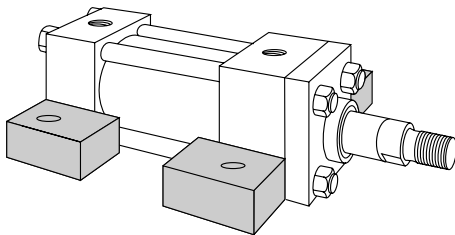

Mounting Dimensions
(See tables on opposite page)

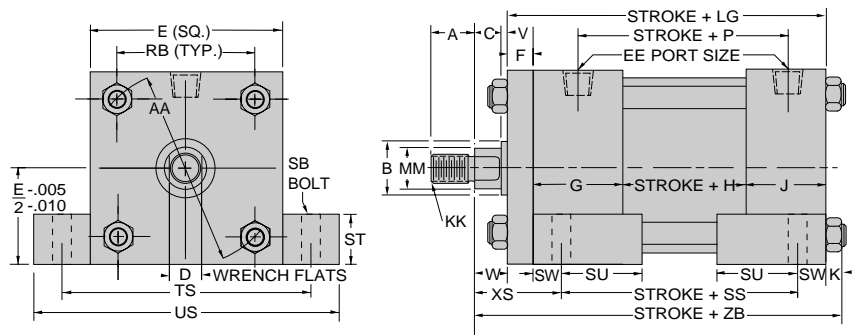

Note: Lugs should be blocked, or a "K" retainer should be mounted on the appropriate end to absorb hydraulic or mechanical shock. Bolts should not carry shear load. See Page 64

Common Rod End Styles & Dimensions (See page 45 for complete listing of rod end styles)

Style No. 2-Standard
Threaded on Turndown Section

Style No. 4
Short Rod End-Internal Threads

Style No. 5
Threaded Intermediate Male

Style No. 6
Studded Rod End
(Available Thru 2" Rod Diameter)

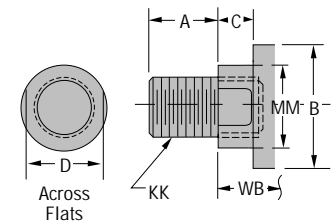
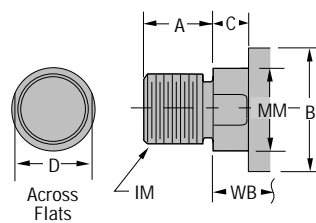
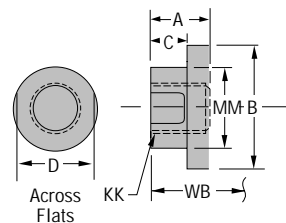
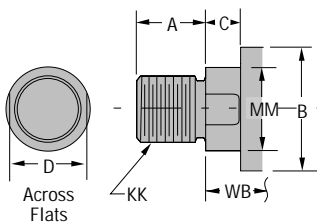

Pressure Limitations For Models 72-B & 72-R

Bore		1½	2	2½	3¼	4	5	6	7	8
Pressure	MOD.	5000	5000	4400	3800	2520	2400	2340	2470	2370
	SEVERE	3000	3000	2640	2280	1510	1440	1400	1480	1420

Miller HV Series Hydraulic Cylinders

Centerline Lug
1½"–8" Bore Cylinders

Model 73-B (NFPA MS3)
Bolted Bushing
Centerline Lug

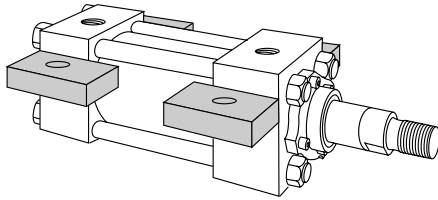

Mounting Dimensions
(See tables on opposite page)

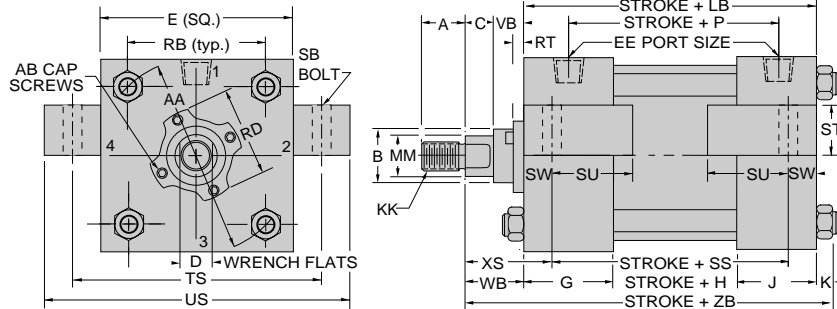

Note: Lugs should be blocked, or pinned on the appropriate end to absorb hydraulic or mechanical shock. Bolts should not carry shear load. See Page 64

Model 73-R (NFPA MS3)
Square Retainer Held Bushing
Centerline Lug

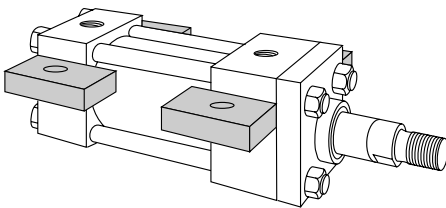

Mounting Dimensions
(See tables on opposite page)

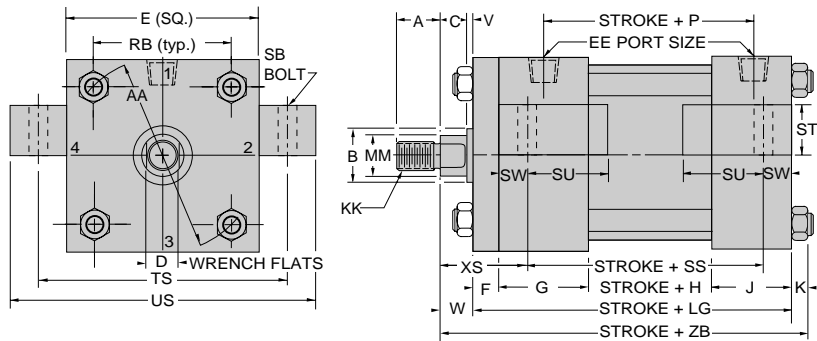

Note: Lugs should be blocked, or pinned on the appropriate end to absorb hydraulic or mechanical shock. Bolts should not carry shear load. See Page 64

Common Rod End Styles & Dimensions (See page 45 for complete listing of rod end styles)

Style No. 2-Standard
Threaded on Turndown Section

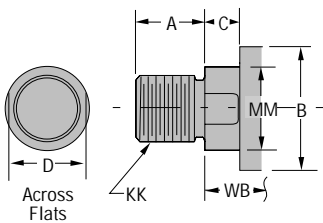

Style No. 4
Short Rod End-Internal Threads

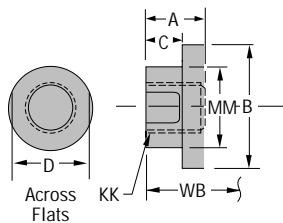

Style No. 5
Threaded Intermediate Male

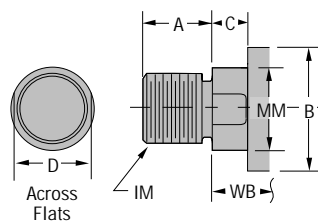

Style No. 6
Studded Rod End
(Available Thru 2" Rod Diameter)

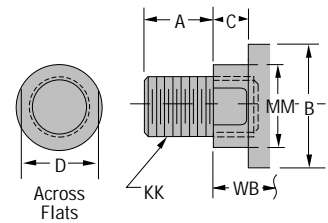

Miller HV Series Hydraulic Cylinders

Centerline Lug 1½" - 8" Bore Cylinders

Cylinder Body Dimensions

Bore Size	E	F	G	J	K	AA	*EE		RB	SB	ST	SU	SW	TS	US
							SAE	NPT							
1½	2½	¾	1¾	1½	¾	2.3	-8	½	1.63	¾	½	1 ⁵ / ₁₆	¾	3¼	4
2	3	5/8	1¾	1½	7/16	2.9	-8	½	2.05	½	¾	1¼	½	4	5
2½	3½	5/8	1¾	1½	7/16	3.6	-8	½	2.55	¾	1	1 ⁹ / ₁₆	1 ¹ / ₁₆	4 ⁷ / ₈	6¼
3¼	4½	¾	2	1¾	9/16	4.6	-12	¾	3.25	¾	1	1 ⁹ / ₁₆	1 ¹ / ₁₆	5 ⁷ / ₈	7¼
4	5	7/8	2	1¾	9/16	5.4	-12	¾	3.82	1	1¼	2	7/8	6¾	8½
5	6½	7/8	2	1¾	1 ³ / ₁₆	7.0	-12	¾	4.95	1	1¼	2	7/8	8¼	10
6	7½	1	2¼	2¼	1 ⁵ / ₁₆	8.1	-16	1	5.73	1¼	1½	2½	1 ¹ / ₈	9¾	12
7	8½		2¾	2¾	1	9.3	-20	1¼	6.58	1½	1¾	2 ⁷ / ₈	1 ³ / ₈	11¼	14
8	9½		3	3	1¼	10.6	-24	1½	7.50	1½	1¾	2 ⁷ / ₈	1 ³ / ₈	12¼	15

Add Stroke

H	LB	LD	LG	P	SS
1¾	4 ⁵ / ₈	4 ⁷ / ₈	5	2 ⁷ / ₈	3 ⁷ / ₈
1¾	4 ⁵ / ₈	4 ⁷ / ₈	5¼	2 ⁷ / ₈	3 ⁵ / ₈
1½	4¾	5	5 ³ / ₈	3	3 ³ / ₈
1¾	5½	5¾	6¼	3½	4½
2	5¾	6	6 ⁵ / ₈	3¾	4
2½	6¼	6½	7½	4¼	4½
2 ⁷ / ₈	7 ³ / ₈	7 ³ / ₈	8 ³ / ₈	4 ⁷ / ₈	5 ¹ / ₈
3	8½	8½		5 ³ / ₈	5¾
3½	9½	9½		6½	6¾

* SAE ports are standard, NPT ports are available at no extra charge.

† LD dimension is for double rod end models. See page 44. For end to end bolt centerlines on double rod-end cylinders, use common dimension "Stroke plus LD" instead of "Stroke Plus SS" and subtract dimension "SW" from each end.

Note: Mounting holes are 1/16" larger than bolt sizes (SB) shown.

Rod End Dimensions

Bore Size	Rod Dia (MM)	A	B -.001 to -.003	C	D	V	W	AB	IM Style 5	KK Styles 2,4&6	RD (Max.)	RT	VB	WB	XS
1½	5/8	¾	1.125	¾	½	¼	5/8	10-32	½-20	7/16-20	1.972	.316	5/8	1	1¾
	1	1 ¹ / ₈	1.500	½	7/8	½	1		7/8-14	¾-16					1¾
2	1	1 ¹ / ₈	1.500	½	7/8	¼	¾	¼-28	7/8-14	¾-16	2.472	.328	7/8	1¾	1 ⁷ / ₈
	1 ³ / ₈	1 ⁵ / ₈	2.000	5/8	1 ¹ / ₈	¾	1		1¼-12	1-14					2 ¹ / ₈
2½	1	1 ¹ / ₈	1.500	½	7/8	¼	¾	¼-28	7/8-14	¾-16	2.472	.328	7/8	1¾	2 ¹ / ₁₆
	1 ³ / ₈	1 ⁵ / ₈	2.000	5/8	1 ¹ / ₈	¾	1	¼-28	1¼-12	1-14	2.972	.328	1	1 ⁵ / ₈	2 ⁵ / ₁₆
	1¾	2	2.375	¾	1½	½	1¼	¼-28	1½-12	1¼-12	3.470	.313	1 ¹ / ₈	1 ⁷ / ₈	2 ⁹ / ₁₆
3¼	1 ³ / ₈	1 ⁵ / ₈	2.000	5/8	1 ¹ / ₈	¼	7/8	¼-28	1¼-12	1-14	2.972	.328	1	1 ⁵ / ₈	2 ⁵ / ₁₆
	1¾	2	2.375	¾	1½	¾	1 ¹ / ₈	¼-28	1½-12	1¼-12	3.470	.313	1 ¹ / ₈	1 ⁷ / ₈	2 ⁹ / ₁₆
4	2	2¼	2.625	7/8	1 ¹¹ / ₁₆	¾	1¼	¼-28	1¾-12	1½-12	3.720	.313	1 ¹ / ₈	2	2 ¹¹ / ₁₆
	1¾	2	2.375	¾	1½	¼	1	¼-28	1½-12	1¼-12	3.470	.313	1 ¹ / ₈	1 ⁷ / ₈	2¾
5	2	2¼	2.625	7/8	1 ¹¹ / ₁₆	¼	1 ¹ / ₈	¼-28	1¾-12	1½-12	3.720	.313	1 ¹ / ₈	2	2 ⁷ / ₈
	2½	3	3.125	1	2 ¹ / ₁₆	¾	1 ³ / ₈	¼-28	2¼-12	1 ⁷ / ₈ -12	4.252	.313	1¼	2¼	3 ¹ / ₈
	3	3½	3.750	1	2 ⁵ / ₈	¾	1 ³ / ₈	¼-28	2¾-12	2¼-12	4.752	.313	1¼	2¼	3 ¹ / ₈
6	3½	3½	4.250	1	3	¾	1 ³ / ₈	¼-28	3¼-12	2½-12	5.252	.313	1¼	2¼	3 ¹ / ₈
	4	4	4.750	1	3 ³ / ₈	¼	1¼	¼-28	3¾-12	3-12	5.939	.610	1¼	2¼	3 ³ / ₈
7	3	3½	3.750	1	2 ⁵ / ₈			¼-28	2¾-12	2¼-12	4.752	.313	1¼	2¼	3 ⁵ / ₈
	3½	3½	4.250	1	3			¼-28	3¼-12	2½-12	5.252	.313	1¼	2¼	3 ⁵ / ₈
	4	4	4.750	1	3 ³ / ₈			5/16-24	3¾-12	3-12	5.939	.610	1¼	2¼	3 ⁵ / ₈
	4½	4½	5.250	1	3 ⁷ / ₈			5/16-24	4¼-12	3¼-12	6.439	.610	1¼	2¼	3 ⁵ / ₈
	5	5	5.750	1	4¼			5/16-24	4¾-12	3½-12	6.939	.610	1¼	2¼	3 ⁵ / ₈
8	3½	3½	4.250	1	3			¼-28	3¼-12	2½-12	5.252	.313	1¼	2¼	3 ⁵ / ₈
	4	4	4.750	1	3 ³ / ₈			5/16-24	3¾-12	3-12	5.939	.610	1¼	2¼	3 ⁵ / ₈
	4½	4½	5.250	1	3 ⁷ / ₈			5/16-24	4¼-12	3¼-12	6.439	.610	1¼	2¼	3 ⁵ / ₈
	5	5	5.750	1	4¼			5/16-24	4¾-12	3½-12	6.939	.610	1¼	2¼	3 ⁵ / ₈
	5½	5½	6.250	1	4 ⁵ / ₈			5/16-24	5¼-12	4-12	7.439	.610	1¼	2¼	3 ⁵ / ₈

Add Stroke

ZB
6
6 ³ / ₈
6 ⁷ / ₁₆
6 ¹¹ / ₁₆
6 ⁹ / ₁₆
6 ¹³ / ₁₆
7 ¹ / ₁₆
7 ¹ / ₁₆
7 ¹⁵ / ₁₆
8 ¹ / ₁₆
8 ³ / ₁₆
8 ⁵ / ₁₆
8 ⁹ / ₁₆
9 ¹ / ₁₆
9 ⁵ / ₁₆
9 ⁹ / ₁₆
9 ⁵ / ₁₆
10 ⁹ / ₁₆
10 ⁹ / ₁₆
10 ⁹ / ₁₆
10 ⁹ / ₁₆
11¾
11¾
11¾
11¾
13
13
13
13

Note: See page 6 for bore, rod, bolted/retainer bushing availability chart.

Miller HV Series Hydraulic Cylinders

Side Tapped
1½" - 8" Bore Cylinders

Model 74-B (NFPA MS4)
Bolted Bushing
Side Tapped

Mounting Dimensions
(See tables on opposite page)

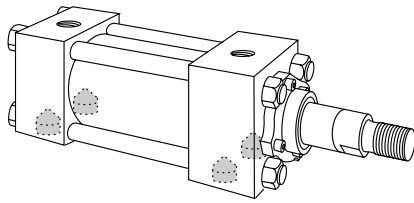

Note: A "K" retainer should be mounted on the appropriate end to absorb hydraulic or mechanical shock. Bolts should not carry shear load. See Page 64

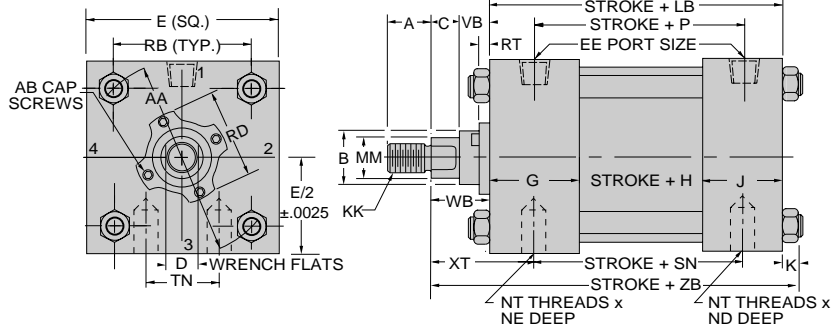

Model 74-R (NFPA MS4)
Square Retainer Held Bushing
Side Tapped

Mounting Dimensions
(See tables on opposite page)

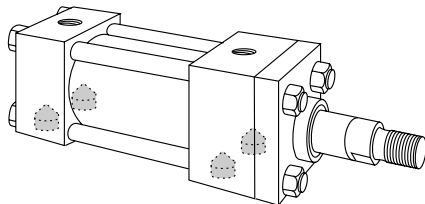

Note: A "K" retainer should be mounted on the appropriate end to absorb hydraulic or mechanical shock. Bolts should not carry shear load. See Page 64

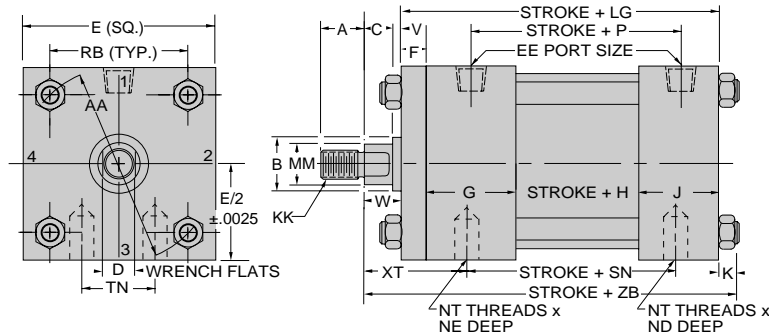

Common Rod End Styles & Dimensions (See page 45 for complete listing of rod end styles)

Style No. 2-Standard
Threaded on Turndown Section

Style No. 4
Short Rod End-Internal Threads

Style No. 5
Threaded Intermediate Male

Style No. 6
Studded Rod End
(Available Thru 2" Rod Diameter)

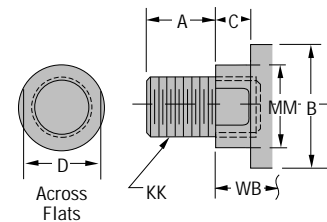
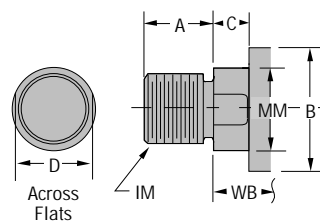
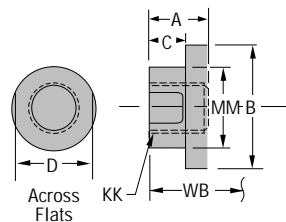
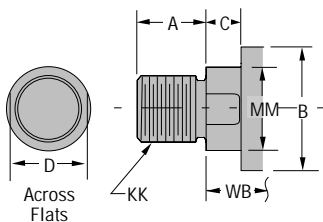

Pressure Limitations For Model 74-B and 74-R

Rod Dia.	5/8"		1"		1 3/8"		1 3/4"		2"		2 1/2"		3"		3 1/2"		4"		4 1/2"		5"		5 1/2"		
	Mod.	Sev.	Mod.	Sev.	Mod.	Sev.	Mod.	Sev.	Mod.	Sev.	Mod.	Sev.	Mod.	Sev.	Mod.	Sev.	Mod.	Sev.	Mod.	Sev.	Mod.	Sev.	Mod.	Sev.	
1 1/2	4700	2820	3600	2160																					
2			4600	2750	3300	1980																			
2 1/2			4300	2580	3700	2220	3100	1860																	
3 1/4					4300	2580	4700	2820	4100	2460															
4							4000	2400	4000	2400	3800	2280													
5									4000	2400	4000	2400	4150	2490	3750	2250									
6											3000	1800	3000	1800	4400	2640	3750	2250							
7													3000	1800	3000	1800	3000	1800	3000	1800	3000	1800	3000	1800	
8															3000	1800	3000	1800	3000	1800	3000	1800	3000	1800	

Note: Reduced pressure ratings on some oversize rod models due to shallow tapped mounting holes in the rod end head. See NE dimension for tap depth.

Miller HV Series Hydraulic Cylinders

Side Tapped
1½" – 8" Bore Cylinders

Cylinder Body Dimensions

Bore Size	E	F	G	J	K	AA	*EE		ND	NT	RB	TN
							SAE	NPT				
1½	2½	¾	1¾	1½	¾	2.3	-8	½	½	¾-16	1.63	¾
2	3	⅝	1¾	1½	⅞	2.9	-8	½	⅞	½-13	2.05	1⅝
2½	3½	⅝	1¾	1½	⅞	3.6	-8	½	⅞	⅝-11	2.55	1⅝
3¼	4½	¾	2	1¾	⅞	4.6	-12	¾	1⅞	¾-10	3.25	1½
4	5	⅞	2	1¾	⅞	5.4	-12	¾	1⅞	1-8	3.82	2⅞
5	6½	⅞	2	1¾	1⅝	7.0	-12	¾	1½	1-8	4.95	2⅝
6	7½	1	2¼	2¼	1⅝	8.1	-16	1	1¾	1¼-7	5.73	3⅞
7	8½		2¾	2¾	1	9.3	-20	1¼	2	1½-6	6.58	3¾
8	9½		3	3	1¼	10.6	-24	1½	2	1½-6	7.50	4¼

Add Stroke

H	LB	‡LD	LG	P	SN‡
1⅜	4⅝	4⅞	5	2⅞	2⅞
1⅜	4⅝	4⅞	5¼	2⅞	2⅞
1½	4¾	5	5⅜	3	3
1¾	5¼	5¾	6¼	3½	3½
2	5¾	6	6⅝	3¾	3¾
2½	6¼	6½	7⅞	4¼	4¼
2⅞	7⅞	7⅞	8⅜	4⅞	5⅞
3	8½	8½		5⅜	5⅞
3½	9½	9½		6⅞	6⅞

* SAE ports are standard, NPT ports are available at no extra charge.

‡ LD dimension is for double rod end models. See page 44.

SN dimension on double rod end (Model DHV-74): For 6" bore is 4⅞", 7" bore SN=5⅜", and 8" bore SN=6⅞".

1½"-5" bores the SN dimension is the same for both single and double rod end cylinders.

Rod End Dimensions

Bore Size	Rod Dia (MM)	A	B -.001 to -.003	C	D	V	W	AB	IM Style 5	KK Styles 2,4&6	NE	RD (Max.)	RT	VB	WB	XT	ZB
1½	⅝	¾	1.125	¾	½	¼	⅝	10-32	½-20	1/16-20	½	1.972	.316	⅝	1	2	6
	1	1⅞	1.500	½	⅞	½	1		⅞-14	¾-16	25/64					2⅜	6⅜
2	1	1⅞	1.500	½	⅞	¼	¾	¼-28	⅞-14	¾-16	⅞	2.472	.328	⅞	1⅞	2⅜	6⅞
	1⅜	1⅞	2.000	⅝	1⅞	¾	1		1¼-12	1-14	⅞					2⅝	6⅞
2½	1	1⅞	1.500	½	⅞	¼	¾	¼-28	⅞-14	¾-16	⅞	2.472	.328	⅞	1⅞	2⅜	6⅞
	1⅜	1⅞	2.000	⅝	1⅞	¾	1	¼-28	1¼-12	1-14	23/32	2.972	.328	1	1⅞	2⅝	6⅞
3¼	1¾	2	2.375	¾	1½	½	1¼	¼-28	1½-12	1¼-12	½	3.470	.313	1⅞	1⅞	2⅞	7⅞
	1⅞	1⅞	2.000	⅝	1⅞	¼	⅞	¼-28	1¼-12	1-14	1⅞	2.972	.328	1	1⅞	2¾	7⅞
4	1¾	2	2.375	¾	1½	¼	⅞	¼-28	1½-12	1¼-12	⅞	3.470	.313	1⅞	1⅞	3	7⅞
	2	2¼	2.625	⅞	1⅞	¾	1¼	¼-28	1¾-12	1½-12	⅞	3.720	.313	1⅞	2	3⅞	8⅞
5	1¾	2	2.375	¾	1½	¼	1	¼-28	1½-12	1¼-12	1⅞	3.470	.313	1⅞	1⅞	3	8⅞
	2	2¼	2.625	⅞	1⅞	¼	1⅞	¼-28	1¾-12	1½-12	1	3.720	.313	1⅞	2	3⅞	8⅞
6	2½	3	3.125	1	2⅞	¾	1⅞	¼-28	2¼-12	1⅞-12	¾	4.252	.313	1¼	2¼	3⅞	8⅞
	2	2¼	2.625	⅞	1⅞	¼	1⅞	¼-28	1¾-12	1½-12	1½	3.720	.313	1⅞	2	3⅞	9⅞
7	2½	3	3.125	1	2⅞	¾	1⅞	¼-28	2¼-12	1⅞-12	1½	4.252	.313	1¼	2¼	3⅞	9⅞
	3	3½	3.750	1	2⅞	¾	1⅞	¼-28	2¾-12	2¼-12	1¼	4.752	.313	1¼	2¼	3⅞	9⅞
8	3½	3½	4.250	1	3	¾	1⅞	¼-28	3¼-12	2½-12	1⅞	5.252	.313	1¼	2¼	3⅞	9⅞
	2½	3	3.125	1	2⅞	¼	1¼	¼-28	2¼-12	1⅞-12	1¾	4.252	.313	1¼	2¼	3½	10⅞
9	3	3½	3.750	1	2⅞			¼-28	2¾-12	2¼-12	2	4.752	.313	1¼	2¼	3⅞	10⅞
	3½	3½	4.250	1	3			¼-28	3¼-12	2½-12	2¼	5.252	.313	1¼	2¼	3⅞	10⅞
10	4	4	4.750	1	3⅞			5/16-24	3¾-12	3-12	1⅝	5.939	.610	1¼	2¼	3⅞	10⅞
	4½	4½	5.250	1	3⅞			5/16-24	4¼-12	3¼-12	1⅞	6.439	.610	1¼	2¼	3⅞	10⅞
11	5	5	5.750	1	4¼			5/16-24	4¾-12	3½-12	1⅞	6.939	.610	1¼	2¼	3⅞	10⅞
	3½	3½	4.250	1	3			¼-28	3¼-12	2½-12	2	5.252	.313	1¼	2¼	3⅞	13
12	4	4	4.750	1	3⅞			5/16-24	3¾-12	3-12	2	5.939	.610	1¼	2¼	3⅞	13
	4½	4½	5.250	1	3⅞			5/16-24	4¼-12	3¼-12	2¼	6.439	.610	1¼	2¼	3⅞	13
13	5	5	5.750	1	4¼			5/16-24	4¾-12	3½-12	1⅞	6.939	.610	1¼	2¼	3⅞	13
	5½	5½	6.250	1	4⅝			5/16-24	5¼-12	4-12	1⅞	7.439	.610	1¼	2¼	3⅞	13

Add Stroke

Note: See page 6 for bore, rod, bolted/retainer bushing availability chart.

Miller HV Series Hydraulic Cylinders

End Lug
1½"–8" Bore Cylinders

Model 77-B (NFPA MS7)
Bolted Bushing
End Lug

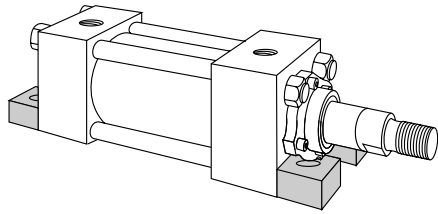

Note: Mounting bolts should not carry shear load. Lugs should be blocked or a "K" retainer should be mounted on the appropriate end to absorb hydraulic or mechanical shock. See Page 64

Mounting Dimensions
(See tables on opposite page)

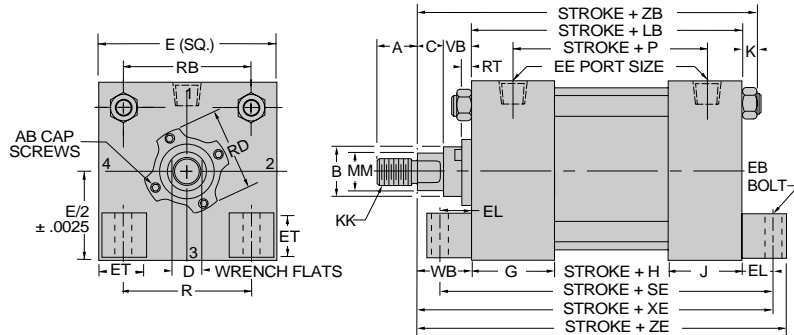

Model 77-R (NFPA MS7)
Square Retainer Held Bushing
End Lug

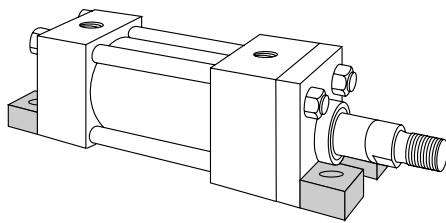

Note: Mounting bolts should not carry shear load. Lugs should be blocked or a "K" retainer should be mounted on the appropriate end to absorb hydraulic or mechanical shock. See Page 64

Mounting Dimensions
(See tables on opposite page)

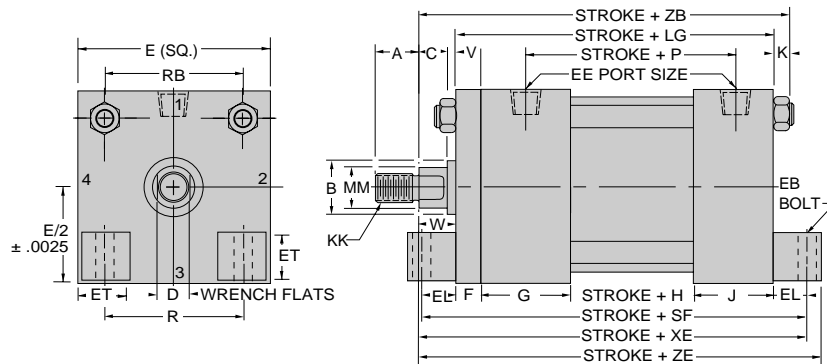

Common Rod End Styles & Dimensions (See page 45 for complete listing of rod end styles)

Style No. 2-Standard
Threaded on Turndown Section

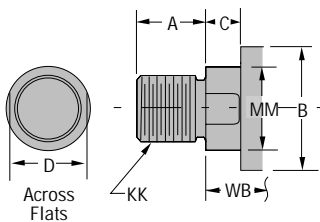

Style No. 4
Short Rod End-Internal Threads

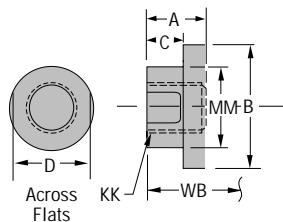

Style No. 5
Threaded Intermediate Male

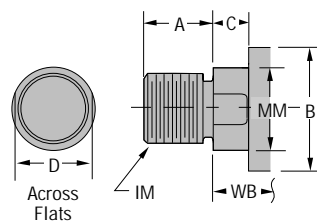

Style No. 6
Studded Rod End
(Available Thru 2" Rod Diameter)

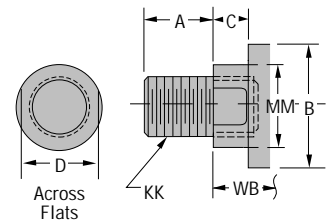

Pressure Limitations For Models 77-B & 77-R

Bore		1½	2	2½	3¼	4	5	6	7	8
Pressure	MOD.	4700	4600	4300	4200	4000	4000	3000	3000	3000
	SEVERE	2820	2760	2580	2520	2400	2400	1800	1800	1800

Miller HV Series Hydraulic Cylinders

End Lug
1½" – 8" Bore Cylinders

Cylinder Body Dimensions

Bore Size	E	F	G	J	K	R	EB	*EE		EL	ET	RB
								SAE	NPT			
1½	2½	¾	1¾	1½	¾	1.63	¾	-8	½	7/8	13/16	1.63
2	3	5/8	1¾	1½	7/16	2.05	½	-8	½	15/16	7/8	2.05
2½	3½	5/8	1¾	1½	7/16	2.55	½	-8	½	15/16	7/8	2.55
3¼	4½	¾	2	1¾	9/16	3.25	5/8	-12	¾	1½	13/16	3.25
4	5	7/8	2	1¾	9/16	3.82	5/8	-12	¾	1½	13/16	3.82
5	6½	7/8	2	1¾	13/16	4.95	7/8	-12	¾	1½	15/32	4.95
6	7½	1	2¼	2¼	15/16	5.73	1	-16	1	11/16	11/16	5.73
7	8½		2¾	2¾	1	6.58	1½	-20	1¼	113/16	127/32	6.58
8	9½		3	3	1¼	7.50	1¼	-24	1½	2	15/16	7.50

* SAE ports are standard, NPT ports are available at no extra charge.
 † LD dimension is for double rod end models. See page 44. For overall length on double rod-end cylinder, use common dimension "Stroke plus LD" instead of figures "ZE", "XE", "SF" and "SE", and add end lug dimensions.
 Note: Mounting holes are 1/16" larger than bolt sizes (FB) shown.

Add Stroke

H	LB	†LD	LG	P	†SE	†SF
1¾	45/8	47/8	5	27/8	63/8	63/4
1¾	45/8	47/8	5¼	27/8	6½	71/8
1½	4¾	5	53/8	3	65/8	7¼
1¾	5½	5¾	6¼	3½	7¾	8½
2	5¾	6	65/8	3¾	8	87/8
2½	6¼	6½	71/8	4¼	9¼	101/8
27/8	73/8	73/8	83/8	47/8	10¾	11¾
3	8½	8½		53/8	121/8	131/8
3½	9½	9½		61/8	13½	14½

Rod End Dimensions

Bore Size	Rod Dia (MM)	A	B -.001 to -.003	C	D	V	W	AB	IM Style 5	KK Styles 2,4&6	RD (Max.)	RT	VB	WB
1½	5/8	¾	1.125	¾	½	¼	5/8	10-32	1/2-20	7/16-20	1.972	.316	5/8	1
	1	11/8	1.500	½	7/8	½	1		7/8-14	¾-16				
2	1	11/8	1.500	½	7/8	¼	¾	¼-28	7/8-14	¾-16	2.472	.328	7/8	13/8
	13/8	15/8	2.000	5/8	11/8	¾	1		1¼-12	1-14				
2½	1	11/8	1.500	½	7/8	¼	¾	¼-28	7/8-14	¾-16	2.472	.328	7/8	13/8
	13/8	15/8	2.000	5/8	11/8	¾	1	¼-28	1¼-12	1-14	2.972	.328	1	15/8
	1¾	2	2.375	¾	1½	½	1¼		1½-12	1¼-12				
3¼	13/8	15/8	2.000	5/8	11/8	¼	7/8	¼-28	1¼-12	1-14	2.972	.328	1	15/8
	1¾	2	2.375	¾	1½	¾	11/8	¼-28	1½-12	1¼-12	3.470	.313	11/8	17/8
	2	2¼	2.625	7/8	111/16	¾	1¼		1¾-12	1½-12				
4	1¾	2	2.375	¾	1½	¼	1	¼-28	1½-12	1¼-12	3.470	.313	11/8	17/8
	2	2¼	2.625	7/8	111/16	¼	11/8	¼-28	1¾-12	1½-12	3.720	.313	11/8	2
	2½	3	3.125	1	21/16	¾	13/8		2¼-12	17/8-12				
5	2	2¼	2.625	7/8	111/16	¼	11/8	¼-28	1¾-12	1½-12	3.720	.313	11/8	2
	2½	3	3.125	1	21/16	¾	13/8	¼-28	2¼-12	17/8-12	4.252	.313	1¼	2¼
	3	3½	3.750	1	25/8	¾	13/8	¼-28	2¾-12	2¼-12	4.752	.313	1¼	2¼
	3½	3½	4.250	1	3	¾	13/8		3¼-12	2½-12				
6	2½	3	3.125	1	21/16	¼	1¼	¼-28	2¼-12	17/8-12	4.252	.313	1¼	2¼
	3	3½	3.750	1	25/8	¼	1¼	¼-28	2¾-12	2¼-12	4.752	.313	1¼	2¼
	3½	3½	4.250	1	3	¼	1¼	¼-28	3¼-12	2½-12	5.252	.313	1¼	2¼
	4	4	4.750	1	33/8	¼	1¼		3¾-12	3-12				
7	3	3½	3.750	1	25/8			¼-28	2¾-12	2¼-12	4.752	.313	1¼	2¼
	3½	3½	4.250	1	3			¼-28	3¼-12	2½-12	5.252	.313	1¼	2¼
	4	4	4.750	1	33/8			5/16-24	3¾-12	3-12	5.939	.610	1¼	2¼
	4½	4½	5.250	1	37/8			5/16-24	4¼-12	3¼-12	6.439	.610	1¼	2¼
8	3½	3½	4.250	1	3			¼-28	3¼-12	2½-12	5.252	.313	1¼	2¼
	4	4	4.750	1	33/8			5/16-24	3¾-12	3-12	5.939	.610	1¼	2¼
	4½	4½	5.250	1	37/8			5/16-24	4¼-12	3¼-12	6.439	.610	1¼	2¼
	5	5	5.750	1	4¼			5/16-24	4¾-12	3½-12	6.939	.610	1¼	2¼
	5½	5½	6.250	1	45/8			5/16-24	5¼-12	4-12	7.439	.610	1¼	2¼

Note: See page 6 for bore, rod, bolted/retainer bushing availability chart and rod eye limitations with certain bore and rod diameter combinations.

Add Stroke

†XE	ZB	†ZE
6½	6	67/8
67/8	63/8	7¼
615/16	67/16	71/16
73/16	611/16	711/16
71/16	69/16	79/16
75/16	613/16	713/16
79/16	71/16	81/16
8¼	711/16	87/8
8½	715/16	91/8
85/8	81/16	9¼
8¾	83/16	93/8
87/8	85/16	9½
91/8	89/16	9¾
9¾	91/16	10½
10	95/16	10¾
10	95/16	10¾
10	95/16	10¾
115/16	109/16	123/16
115/16	109/16	123/16
115/16	109/16	123/16
115/16	109/16	123/16
129/16	11¾	139/16
129/16	11¾	139/16
129/16	11¾	139/16
129/16	11¾	139/16
13¾	13	147/8
13¾	13	147/8
13¾	13	147/8
13¾	13	147/8

Miller HV Series Hydraulic Cylinders

End Angle
1½" - 6" Bore Cylinders

Model 71-R (NFPA MS1)
Square Retainer Held Bushing
End Angle

Mounting Dimensions
(See tables on opposite page)

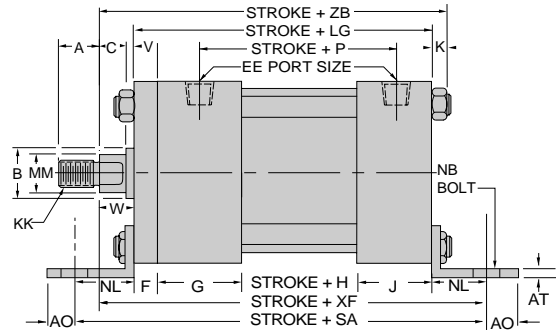
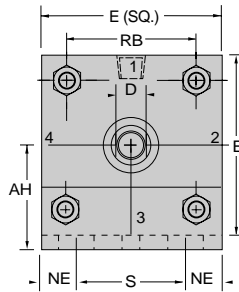
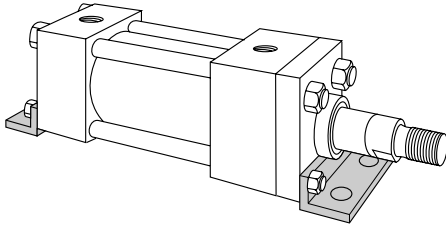

Note: Mounting bolts should not carry shear load. Lugs should be blocked or a "K" retainer should be mounted on the appropriate end to absorb hydraulic or mechanical shock. See Page 64

Common Rod End Styles & Dimensions (See page 45 for complete listing of rod end styles)

Style No. 2-Standard
Threaded on Turndown Section

Style No. 4
Short Rod End-Internal Threads

Style No. 5
Threaded Intermediate Male

Style No. 6
Studded Rod End
(Available Thru 2" Rod Diameter)

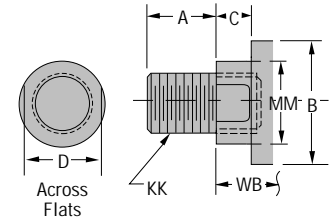
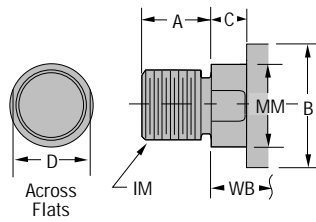
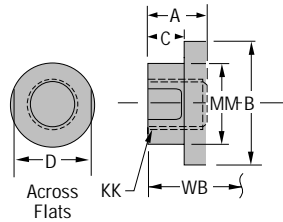
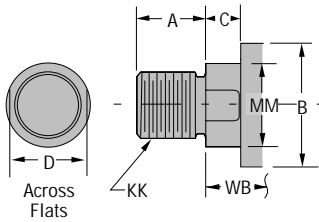

Note: Pressure rating for Model HV-71 cylinders will vary based on cylinder stroke and loads. Use Model HV-77 in place of the end angle mount wherever possible or check with Miller Application Engineering Dept. for specific HV-71 cylinder pressure rating.

Miller HV Series Hydraulic Cylinders

End Angle
1½" – 8" Bore Cylinders

Cylinder Body Dimensions

Bore Size	E	F	G	J	K	S	AH	AO	AT	*EE		NB	NE	NL	RB
										SAE	NPT				
1½	2½	¾	1¾	1½	¾	1¾	1¾	¾	1/8	-8	½	¾	¾	1	1.63
2	3	5/8	1¾	1½	7/16	2	1 ¹¹ / ₁₆	½	1/8	-8	½	½	½	1¼	2.05
2½	3½	5/8	1¾	1½	7/16	2¾	1 ¹⁵ / ₁₆	9/16	1/8	-8	½	5/8	9/16	1 ³ / ₁₆	2.55
3¼	4½	¾	2	1¾	9/16	3¼	2 ⁹ / ₁₆	1 ¹ / ₁₆	¼	-12	¾	¾	1 ¹ / ₁₆	1 ³ / ₁₆	3.25
4	5	7/8	2	1¾	9/16	3¼	2 ¹³ / ₁₆	7/8	¼	-12	¾	1	7/8	2 ¹ / ₈	3.82
5	6½	7/8	2	1¾	1 ³ / ₁₆	4¾	3 ¹ / ₁₆	7/8	5/16	-12	¾	1	7/8	2 ¹ / ₈	4.95
6	7½	1	2¼	2¼	1 ⁵ / ₁₆	5¾	4¼	1 ¹ / ₁₆	¾	-16	1	1¼	1 ¹ / ₁₆	2 ⁷ / ₁₆	5.73

* SAE ports are standard, NPT ports are available at no extra charge.
 † LD dimension is for double rod end models. See page 44. For overall length on double rod-end cylinder, use common dimension "Stroke plus LD" instead of figures "XF", and "SA", and add end angle dimensions.
 Note: Mounting holes are 1/16" larger than bolt sizes (NB) shown.

Add Stroke

H	‡LD	LG	P	‡SA
1¾	4¾	5	2 ⁷ / ₈	7
1¾	4¾	5¼	2 ⁷ / ₈	7¾
1½	5	5¾	3	7¾
1¾	5¾	6¼	3½	9 ⁷ / ₈
2	6	6 ⁵ / ₈	3¾	10 ⁷ / ₈
2½	6½	7 ¹ / ₈	4¼	11 ³ / ₈
2½	7¾	8¾	4 ⁷ / ₈	13¼

Rod End Dimensions

Bore Size	Rod Dia (MM)	A	B -.001 to -.003	C	D	V	W	IM Style 5	KK Styles 2,4,6
1½	5/8	¾	1.125	¾	½	¼	5/8	½-20	7/16-20
	1	1½	1.500	½	7/8	½	1	7/8-14	¾-16
2	1	1½	1.500	½	7/8	¼	¾	7/8-14	¾-16
	1¾	1¾	2.000	5/8	1½	¾	1	1¼-12	1-14
2½	1	1½	1.500	½	7/8	¼	¾	7/8-14	¾-16
	1¾	1¾	2.000	5/8	1½	¾	1	1¼-12	1-14
	1¾	2	2.375	¾	1½	½	1¼	1½-12	1¼-12
3¼	1¾	1¾	2.000	5/8	1½	¼	7/8	1¼-12	1-14
	1¾	2	2.375	¾	1½	¾	1½	1½-12	1¼-12
	2	2¼	2.625	7/8	1 ¹ / ₁₆	¾	1¼	1¾-12	1½-12
4	1¾	2	2.375	¾	1½	¼	1	1½-12	1¼-12
	2	2¼	2.625	7/8	1 ¹ / ₁₆	¼	1½	1¾-12	1½-12
	2½	3	3.125	1	2 ¹ / ₁₆	¾	1¾	2¼-12	1¾-12
5	2	2¼	2.625	7/8	1 ¹ / ₁₆	¼	1½	1¾-12	1½-12
	2½	3	3.125	1	2 ¹ / ₁₆	¾	1¾	2¼-12	1¾-12
	3	3½	3.750	1	2 ⁵ / ₈	¾	1¾	2¾-12	2¼-12
	3½	3½	4.250	1	3	¾	1¾	3¼-12	2½-12
6	2½	3	3.125	1	2 ¹ / ₁₆	¼	1¼	2¼-12	1¾-12
	3	3½	3.750	1	2 ⁵ / ₈	¼	1¼	2¾-12	2¼-12
	3½	3½	4.250	1	3	¼	1¼	3¼-12	2½-12
	4	4	4.750	1	3¾	¼	1¼	3¾-12	3-12

Note: See page 6 for bore, rod, bolted/retainer bushing availability chart.

Add Stroke

‡XF	ZB
6 ⁵ / ₈	6
7	6 ³ / ₈
7¼	6 ¹ / ₁₆
7½	6 ¹¹ / ₁₆
7 ⁵ / ₁₆	6 ⁹ / ₁₆
7 ⁹ / ₁₆	6 ¹³ / ₁₆
7 ¹³ / ₁₆	7 ¹ / ₁₆
8 ¹⁵ / ₁₆	7 ¹ / ₁₆
9 ³ / ₁₆	7 ¹⁵ / ₁₆
9 ⁵ / ₁₆	8 ¹ / ₁₆
9 ³ / ₄	8 ³ / ₁₆
9 ⁷ / ₈	8 ⁵ / ₁₆
10 ¹ / ₈	8 ⁹ / ₁₆
10 ³ / ₈	9 ¹ / ₁₆
10 ⁵ / ₈	9 ⁵ / ₁₆
10 ⁵ / ₈	9 ⁵ / ₁₆
12 ¹ / ₁₆	10 ⁹ / ₁₆
12 ¹ / ₁₆	10 ⁹ / ₁₆
12 ¹ / ₁₆	10 ⁹ / ₁₆
12 ¹ / ₁₆	10 ⁹ / ₁₆

Miller HV Series Hydraulic Cylinders

Trunnion/Head End
1½" – 8" Bore Cylinders

Model 81-B (NFPA MT1)
Bolted Bushing
Trunnion Head End

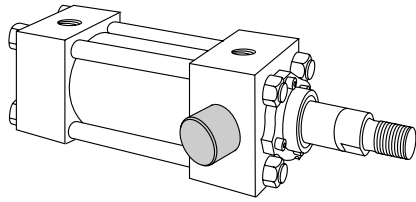

Note: Pins designed for shear, (not bending) loads.

Mounting Dimensions
(See tables on opposite page)

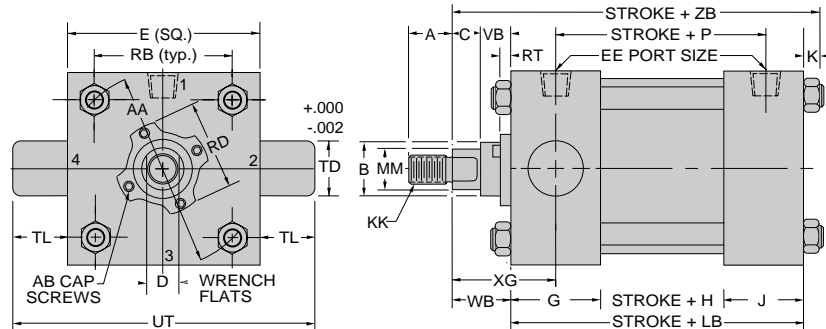

Model 81-R (NFPA MT1)
Rectangular Retainer
Trunnion Head End

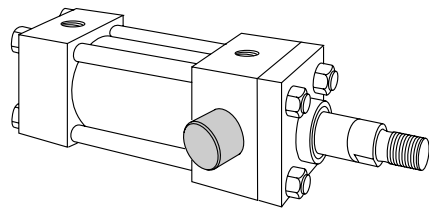

Note: Pins designed for shear, (not bending) loads.

Mounting Dimensions
(See tables on opposite page)

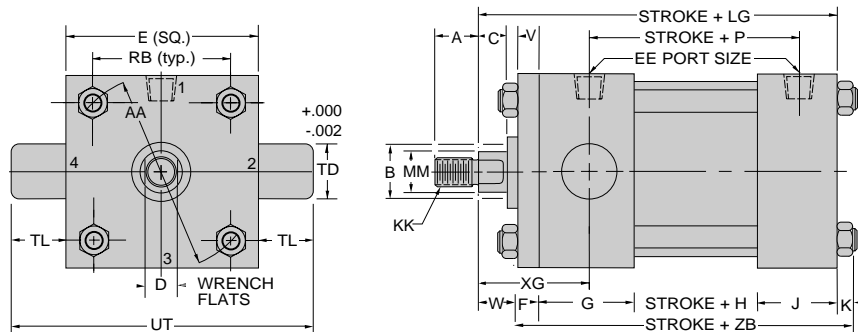

Common Rod End Styles & Dimensions (See page 45 for complete listing of rod end styles)

Style No. 2-Standard
Threaded on Turndown Section

Style No. 4
Short Rod End-Internal Threads

Style No. 5
Threaded Intermediate Male

Style No. 6
Studded Rod End
(Available Thru 2" Rod Diameter)

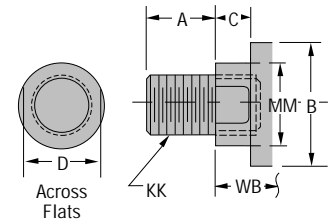
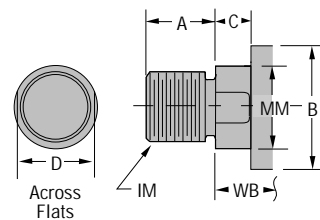
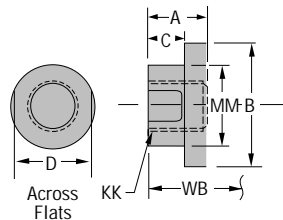
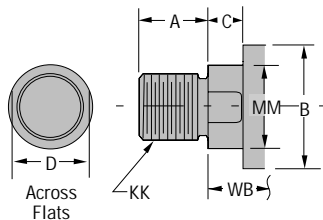

Pressure Limitations For Models 81-B & 81-R

Bore		4	5	6	7	8
Pressure	MOD.	3760	2410	2190	2510	2770
	SEVERE	2250	1440	1310	1500	1660

Miller HV Series Hydraulic Cylinders

Trunnion/Head End
1 1/2"–8" Bore Cylinders

Cylinder Body Dimensions

Bore Size	E	F	G	J	K	AA	*EE		RB	TD	TL	UT
							SAE	NAE				
1 1/2	2 1/2	3/8	1 3/4	1 1/2	3/8	2.3	-8	1/2	1.63	1	1	4 1/2
2	3	5/8	1 3/4	1 1/2	7/16	2.9	-8	1/2	2.05	1 3/8	1 3/8	5 3/4
2 1/2	3 1/2	5/8	1 3/4	1 1/2	7/16	3.6	-8	1/2	2.55	1 3/8	1 3/8	6 1/4
3 1/4	4 1/2	3/4	2	1 3/4	9/16	4.3	-12	3/4	3.25	1 3/4	1 3/4	8
4	5	7/8	2	1 3/4	9/16	5.4	-12	3/4	3.82	1 3/4	1 3/4	8 1/2
5	6 1/2	7/8	2	1 3/4	13/16	7.0	-12	3/4	4.95	1 3/4	1 3/4	10
6	7 1/2	1	2 1/4	2 1/4	15/16	8.1	-16	1	5.73	2	2	11 1/2
7	8 1/2		2 3/4	2 3/4	1	9.3	-20	1 1/4	6.58	2 1/2	2 1/2	13 1/2
8	9 1/2		3	3	1 1/4	10.6	-24	1 1/2	7.50	3	3	15 1/2

* SAE ports are standard, NPT ports are available at no extra charge.
† LD dimension is for double rod end models. See page 44.

Add Stroke

H	LB	†LD	LG	P
1 3/8	4 5/8	4 7/8	5	2 7/8
1 3/8	4 5/8	4 7/8	5 1/4	2 7/8
1 1/2	4 3/4	5	5 3/8	3
1 3/4	5 1/2	5 3/4	6 1/4	3 1/2
2	5 3/4	6	6 5/8	3 3/4
2 1/2	6 1/4	6 1/2	7 1/8	4 1/4
2 7/8	7 3/8	7 3/8	8 3/8	4 7/8
3	8 1/2	8 1/2		5 3/8
3 1/2	9 1/2	9 1/2		6 1/8

Rod End Dimensions

Bore Size	Rod Dia (MM)	A	B -.001 to -.003	C	D	V	W	AB	IM Style 5	KK Styles 2,4&6	RD (Max.)	RT	VB	WB	XG	ZB
1 1/2	5/8	3/4	1.125	3/8	1/2	1/4	5/8	10-32	1/2-20	7/16-20	1.972	.316	5/8	1	1 7/8	6
	1	1 1/8	1.500	1/2	7/8	1/2	1		7/8-14	3/4-16					2 1/4	6 3/8
2	1	1 1/8	1.500	1/2	7/8	1/4	3/4	1/4-28	7/8-14	3/4-16	2.472	.328	7/8	1 3/8	2 1/4	6 7/16
	1 3/8	1 5/8	2.000	5/8	1 1/8	3/8	1		1 1/4-12	1-14					2 1/2	6 11/16
2 1/2	1	1 1/8	1.500	1/2	7/8	1/4	3/4	1/4-28	7/8-14	3/4-16	2.472	.328	7/8	1 3/8	2 1/4	6 9/16
	1 3/8	1 5/8	2.000	5/8	1 1/8	3/8	1	1/4-28	1 1/4-12	1-14	2.972	.328	1	1 5/8	2 1/2	6 13/16
	1 3/4	2	2.375	3/4	1 1/2	1/2	1 1/4	1/4-28	1 1/2-12	1 1/4-12	3.470	.313	1 1/8	1 7/8	2 3/4	7 1/16
3 1/4	1 3/8	1 5/8	2.000	5/8	1 1/8	1/4	7/8	1/4-28	1 1/4-12	1-14	2.972	.328	1	1 5/8	2 5/8	7 11/16
	1 3/4	2	2.375	3/4	1 1/2	3/8	1 1/8	1/4-28	1 1/2-12	1 1/4-12	3.470	.313	1 1/8	1 7/8	2 7/8	7 15/16
	2	2 1/4	2.625	7/8	1 11/16	3/8	1 1/4	1/4-28	1 3/4-12	1 1/2-12	3.720	.313	1 1/8	2	3	8 1/16
4	1 3/4	2	2.375	3/4	1 1/2	1/4	1	1/4-28	1 1/2-12	1 1/4-12	3.470	.313	1 1/8	1 7/8	2 7/8	8 3/16
	2	2 1/4	2.625	7/8	1 11/16	1/4	1 1/8	1/4-28	1 3/4-12	1 1/2-12	3.720	.313	1 1/8	2	3	8 5/16
	2 1/2	3	3.125	1	2 1/16	3/8	1 3/8	1/4-28	2 1/4-12	1 7/8-12	4.252	.313	1 1/4	2 1/4	3 1/4	8 9/16
5	2	2 1/4	2.625	7/8	1 11/16	1/4	1 1/8	1/4-28	1 3/4-12	1 1/2-12	3.720	.313	1 1/8	2	3	9 1/16
	2 1/2	3	3.125	1	2 1/16	3/8	1 3/8	1/4-28	2 1/4-12	1 7/8-12	4.252	.313	1 1/4	2 1/4	3 1/4	9 5/16
	3	3 1/2	3.750	1	2 5/8	3/8	1 3/8	1/4-28	2 3/4-12	2 1/4-12	4.752	.313	1 1/4	2 1/4	3 1/4	9 9/16
	3 1/2	3 1/2	4.250	1	3	3/8	1 3/8	1/4-28	3 1/4-12	2 1/2-12	5.252	.313	1 1/4	2 1/4	3 1/4	9 5/16
6	2 1/2	3	3.125	1	2 1/16	1/4	1 1/4	1/4-28	2 1/4-12	1 7/8-12	4.252	.313	1 1/4	2 1/4	3 3/8	10 9/16
	3	3 1/2	3.750	1	2 5/8	1/4	1 1/4	1/4-28	2 3/4-12	2 1/4-12	4.752	.313	1 1/4	2 1/4	3 3/8	10 9/16
	3 1/2	3 1/2	4.250	1	3	1/4	1 1/4	1/4-28	3 1/4-12	2 1/2-12	5.252	.313	1 1/4	2 1/4	3 3/8	10 9/16
	4	4	4.750	1	3 3/8	1/4	1 1/4	5/16-24	3 1/4-12	3-12	5.939	.610	1 1/4	2 1/4	3 3/8	10 9/16
7	3	3 1/2	3.750	1	2 5/8			1/4-28	2 3/4-12	2 1/4-12	4.752	.313	1 1/4	2 1/4	3 5/8	11 3/4
	3 1/2	3 1/2	4.250	1	3			1/4-28	3 1/4-12	2 1/2-12	5.252	.313	1 1/4	2 1/4	3 5/8	11 3/4
	4	4	4.750	1	3 3/8			5/16-24	3 1/4-12	3-12	5.939	.610	1 1/4	2 1/4	3 5/8	11 3/4
	4 1/2	4 1/2	5.250	1	3 7/8			5/16-24	4 1/4-12	3 1/4-12	6.439	.610	1 1/4	2 1/4	3 5/8	11 3/4
	5	5	5.750	1	4 1/4			5/16-24	4 3/4-12	3 1/2-12	6.939	.610	1 1/4	2 1/4	3 5/8	11 3/4
8	3 1/2	3 1/2	4.250	1	3			1/4-28	3 1/4-12	2 1/2-12	5.252	.313	1 1/4	2 1/4	3 3/4	13
	4	4	4.750	1	3 3/8			5/16-24	3 3/4-12	3-12	5.939	.610	1 1/4	2 1/4	3 3/4	13
	4 1/2	4 1/2	5.250	1	3 7/8			5/16-24	4 1/4-12	3 1/4-12	6.439	.610	1 1/4	2 1/4	3 3/4	13
	5	5	5.750	1	4 1/4			5/16-24	4 3/4-12	3 1/2-12	6.939	.610	1 1/4	2 1/4	3 3/4	13
	5 1/2	5 1/2	6.250	1	4 5/8			5/16-24	5 1/4-12	4-12	7.439	.610	1 1/4	2 1/4	3 3/4	13

Note: See page 6 for bore, rod, bolted/retainer bushing availability chart.

Miller HV Series Hydraulic Cylinders

Trunnion/Cap End
1½" – 8" Bore Cylinders

Model 82-B (NFPA MT2)
Bolted Bushing
Trunnion Cap End

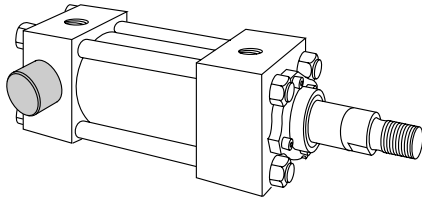

Note: Pins designed for shear (not bending) loads.

Mounting Dimensions
(See tables on opposite page)

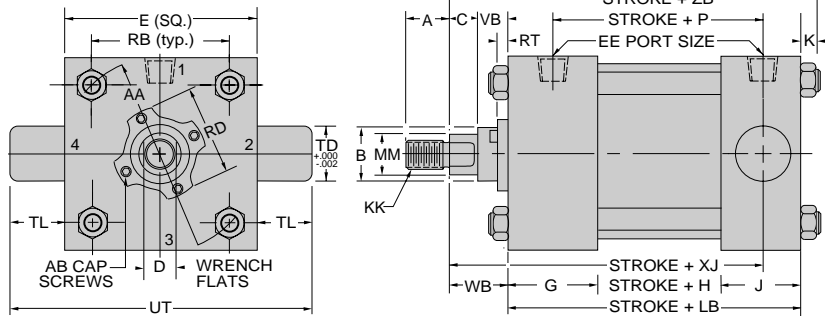

Model 82-R (NFPA MT2)
Square Retainer Held Bushing
Trunnion Cap End

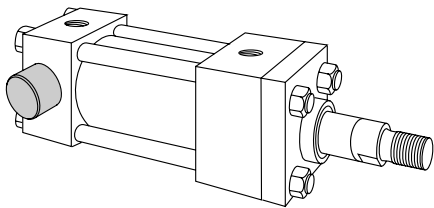

Note: Pins designed for shear (not bending) loads.

Mounting Dimensions
(See tables on opposite page)

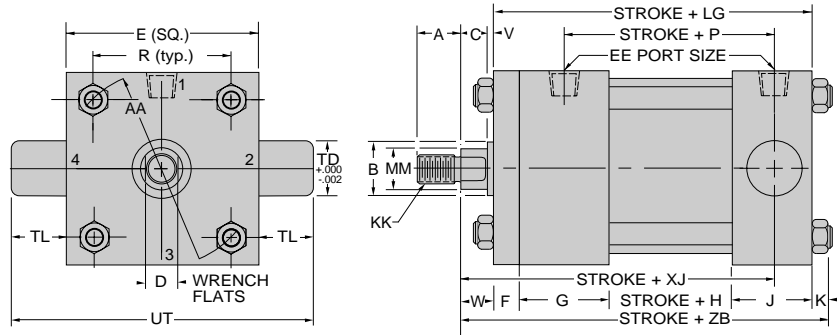

Common Rod End Styles & Dimensions (See page 45 for complete listing of rod end styles)

Style No. 2-Standard
Threaded on Turndown Section

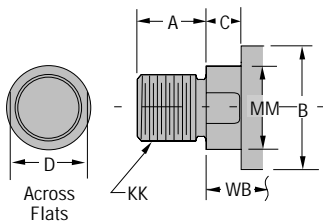

Style No. 4
Short Rod End-Internal Threads

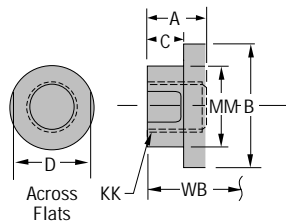

Style No. 5
Threaded Intermediate Male

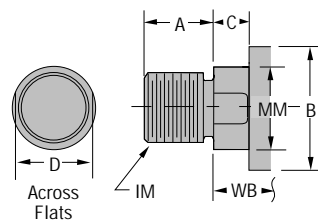

Style No. 6
Studded Rod End
(Available Thru 2" Rod Diameter)

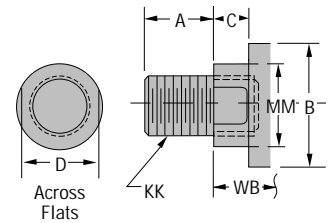

Pressure Limitations For Models 82-B & 82-R

Bore		4	5	6	7	8
Pressure	MOD.	3760	2410	2190	2510	2770
	SEVERE	2250	1440	1310	1500	1660

Miller HV Series Hydraulic Cylinders

Trunnion/Cap End
1 1/2"–8" Bore Cylinders

Cylinder Body Dimensions

Bore Size	E	F	G	J	K	AA	*EE		RB	TD	TL	UT
							SAE	NAE				
1 1/2	2 1/2	3/8	1 3/4	1 1/2	3/8	2.3	-8	1/2	1.63	1	1	4 1/2
2	3	5/8	1 3/4	1 1/2	7/16	2.9	-8	1/2	2.05	1 3/8	1 3/8	5 3/4
2 1/2	3 1/2	5/8	1 3/4	1 1/2	7/16	3.6	-8	1/2	2.55	1 3/8	1 3/8	6 1/4
3 1/4	4 1/2	3/4	2	1 3/4	9/16	4.3	-12	3/4	3.25	1 3/4	1 3/4	8
4	5	7/8	2	1 3/4	9/16	5.4	-12	3/4	3.82	1 3/4	1 3/4	8 1/2
5	6 1/2	7/8	2	1 3/4	13/16	7.0	-12	3/4	4.95	1 3/4	1 3/4	10
6	7 1/2	1	2 1/4	2 1/4	15/16	8.1	-16	1	5.73	2	2	11 1/2
7	8 1/2		2 3/4	2 3/4	1	9.3	-20	1 1/4	6.58	2 1/2	2 1/2	13 1/2
8	9 1/2		3	3	1 1/4	10.6	-24	1 1/2	7.50	3	3	15 1/2

Add Stroke

H	LB	LG	P
1 3/8	4 5/8	5	2 7/8
1 3/8	4 5/8	5 1/4	2 7/8
1 1/2	4 3/4	5 3/8	3
1 3/4	5 1/2	6 1/4	3 1/2
2	5 3/4	6 5/8	3 3/4
2 1/2	6 1/4	7 1/8	4 1/4
2 7/8	7 3/8	8 3/8	4 7/8
3	8 1/2		5 3/8
3 1/2	9 1/2		6 1/8

* SAE ports are standard, NPT ports are available at no extra charge.

Rod End Dimensions

Bore Size	Rod Dia (MM)	A	B -.001 to -.003	C	D	V	W	AB	IM Style 5	KK Styles 2,4&6	RD (Max.)	RT	VB	WB
1 1/2	5/8	3/4	1.125	3/8	1/2	1/4	5/8	10-32	1/2-20	7/16-20	1.972	.316	5/8	1
	1	1 1/8	1.500	1/2	7/8	1/2	1		7/8-14	3/4-16				
2	1	1 1/8	1.500	1/2	7/8	1/4	3/4	1 1/4-28	7/8-14	3/4-16	2.472	.328	7/8	1 3/8
	1 3/8	1 5/8	2.000	5/8	1 1/8	3/8	1		1 1/4-12	1-14				
2 1/2	1	1 1/8	1.500	1/2	7/8	1/4	3/4	1 1/4-28	7/8-14	3/4-16	2.472	.328	7/8	1 3/8
	1 3/8	1 5/8	2.000	5/8	1 1/8	3/8	1	1 1/4-28	1 1/4-12	1-14	2.972	.328	1	1 5/8
3 1/4	1 3/4	2	2.375	3/4	1 1/2	1/2	1 1/4	1 1/4-28	1 1/2-12	1 1/4-12	3.470	.313	1 1/8	1 7/8
	1 3/8	1 5/8	2.000	5/8	1 1/8	1/4	7/8	1 1/4-28	1 1/4-12	1-14	2.972	.328	1	1 5/8
4	1 3/4	2	2.375	3/4	1 1/2	3/8	1 1/8	1 1/4-28	1 1/2-12	1 1/4-12	3.470	.313	1 1/8	1 7/8
	2	2 1/4	2.625	7/8	1 11/16	3/8	1 1/4	1 1/4-28	1 3/4-12	1 1/2-12	3.720	.313	1 1/8	2
5	1 3/4	2	2.375	3/4	1 1/2	1/4	1	1 1/4-28	1 1/2-12	1 1/4-12	3.470	.313	1 1/8	1 7/8
	2	2 1/4	2.625	7/8	1 11/16	1/4	1 1/8	1 1/4-28	1 3/4-12	1 1/2-12	3.720	.313	1 1/8	2
6	2 1/2	3	3.125	1	2 1/16	3/8	1 3/8	1 1/4-28	2 1/4-12	1 7/8-12	4.252	.313	1 1/4	2 1/4
	2 1/2	3	3.125	1	2 1/16	1/4	1 1/4	1 1/4-28	2 3/4-12	2 1/4-12	4.752	.313	1 1/4	2 1/4
7	3 1/2	3 1/2	4.250	1	3	3/8	1 3/8	1 1/4-28	3 1/4-12	2 1/2-12	5.252	.313	1 1/4	2 1/4
	2 1/2	3	3.125	1	2 1/16	1/4	1 1/4	1 1/4-28	2 1/4-12	1 7/8-12	4.252	.313	1 1/4	2 1/4
8	3 1/2	3 1/2	4.250	1	3			1 1/4-28	2 3/4-12	2 1/4-12	4.752	.313	1 1/4	2 1/4
	3 1/2	3 1/2	4.250	1	3			1 1/4-28	2 3/4-12	2 1/4-12	4.752	.313	1 1/4	2 1/4
9	4	4	4.750	1	3 3/8			5/16-24	3 1/4-12	3-12	5.939	.610	1 1/4	2 1/4
	4 1/2	4 1/2	5.250	1	3 7/8			5/16-24	4 1/4-12	3 1/4-12	6.439	.610	1 1/4	2 1/4
10	5	5	5.750	1	4 1/4			5/16-24	4 3/4-12	3 1/2-12	6.939	.610	1 1/4	2 1/4
	3 1/2	3 1/2	4.250	1	3			1 1/4-28	3 1/4-12	2 1/2-12	5.252	.313	1 1/4	2 1/4
11	4	4	4.750	1	3 3/8			5/16-24	3 3/4-12	3-12	5.939	.610	1 1/4	2 1/4
	4 1/2	4 1/2	5.250	1	3 7/8			5/16-24	4 1/4-12	3 1/4-12	6.439	.610	1 1/4	2 1/4
12	5	5	5.750	1	4 1/4			5/16-24	4 3/4-12	3 1/2-12	6.939	.610	1 1/4	2 1/4
	5 1/2	5 1/2	6.250	1	4 5/8			5/16-24	5 1/4-12	4-12	7.439	.610	1 1/4	2 1/4

Note: See page 6 for bore, rod, bolted/retainer bushing availability chart.

Miller HV Series Hydraulic Cylinders

Intermediate Trunnion
1½" – 8" Bore Cylinders

Model 89-B (NFPA MT4) Bolted Bushing Intermediate Trunnion

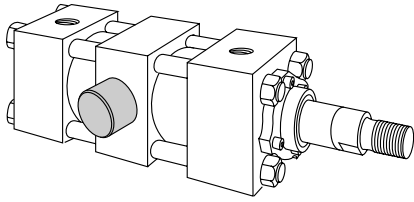

Note: Pins designed for shear (not bending) loads.
Specify dimension "XI" when ordering.

Mounting Dimensions (See tables on opposite page)

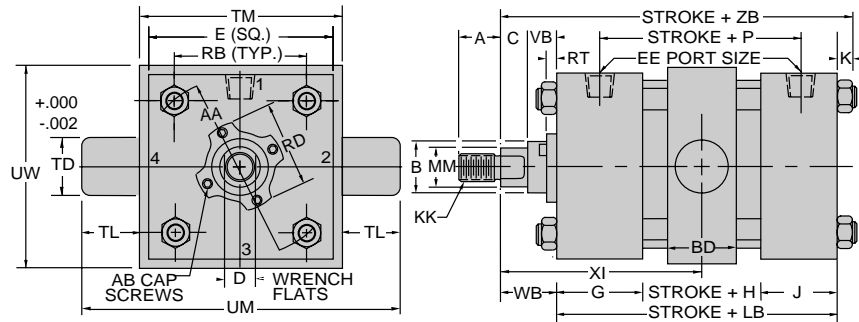

Model 89-R (NFPA MT4) Square Retainer Held Bushing Intermediate Trunnion

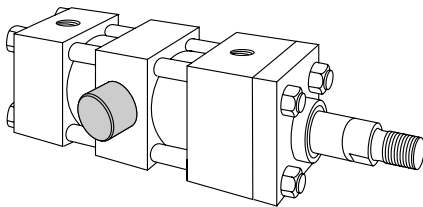

Note:
Pins designed for shear (not bending) loads.
Specify dimension "XI" when ordering.

Mounting Dimensions (See tables on opposite page)

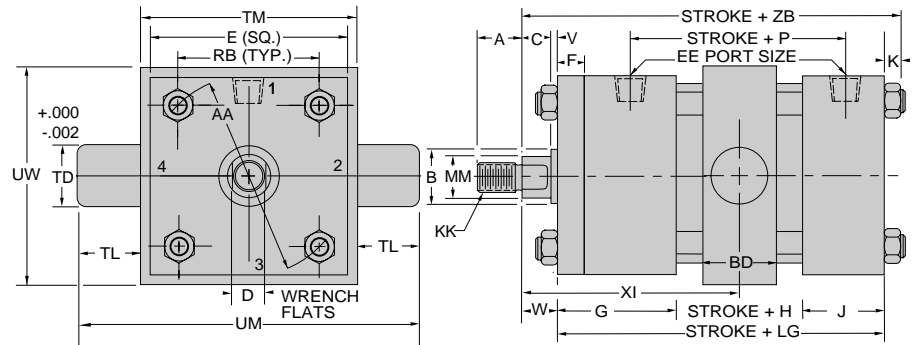

Common Rod End Styles & Dimensions (See page 45 for complete listing of rod end styles)

Style No. 2-Standard
Threaded on Turndown Section

Style No. 4
Short Rod End-Internal Threads

Style No. 5
Threaded Intermediate Male

Style No. 6
Studded Rod End
(Available Thru 2" Rod Diameter)

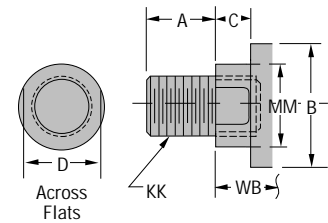
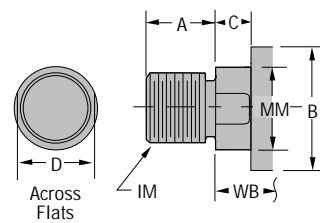
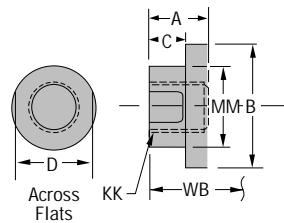
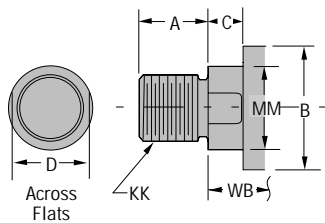

Pressure Limitations For Models 89-B & 89-R

Bore		3¼	4	5	6	7	8
Pressure	MOD.	4220	2780	1780	1830	2510	1380
	SEVERE	2530	1660	1060	1090	1500	820

Miller HV Series Hydraulic Cylinders

Intermediate Trunnion
1½" – 8" Bore Cylinders

Cylinder Body Dimensions

Bore Size	E	F	G	J	K	AA	BD	*EE		RB	TD	TL	TM	UM	UW
								SAE	NPT						
1½	2½	¾	1¾	1½	¾	2.3	1¼	-8	½	1.63	1	1	3	5	3¼
2	3	⅝	1¾	1½	⅞	2.9	1½	-8	½	2.05	1¾	1¾	3½	6¼	4
2½	3½	⅝	1¾	1½	⅞	3.6	1¾	-8	½	2.55	1¾	1¾	4	6¾	4½
3¼	4½	¾	2	1¾	⅞	4.6	2¼	-12	¾	3.25	1¾	1¾	5	8½	5¾
4	5	⅞	2	1¾	⅞	5.4	2½	-12	¾	3.82	1¾	1¾	5½	9	6
5	6½	⅞	2	1¾	⅞	7.0	2½	-12	¾	4.95	1¾	1¾	7	10½	8
6	7½	1	2¼	2¼	⅞	8.1	3	-16	1	5.73	2	2	8½	12½	9½
7	8½		2¾	2¾	1	9.3	3½	-20	1¼	6.58	2½	2½	9¾	14¾	11¾
8	9½		3	3	1¼	10.6	4	-24	1½	7.50	3	3	11	17	12

* SAE ports are standard, NPT ports are available at no extra charge.
† LD dimension is for double rod end models. See page 44.

Add Stroke

H	LB	†LD	LG	P
1¾	4⅝	4⅞	5	2⅞
1¾	4⅝	4⅞	5¼	2⅞
1½	4¾	5	5⅝	3
1¾	5½	5¾	6¼	3½
2	5¾	6	6⅝	3¾
2½	6¼	6½	7⅞	4¼
2⅞	7¾	7⅞	8⅞	4⅞
3	8½	8½		5⅞
3½	9½	9½		6⅞

Rod End Dimensions

Bore Size	Rod Dia (MM)	A	B -.001 to -.003	C	D	V	W	AB	IM Style 5	KK Styles 2,4&6	RD (Max.)	RT	VB	WB	ZB
	1	1⅞	1.500	½	⅞	½	1		⅞-14	¾-16					6⅝
2	1	1⅞	1.500	½	⅞	¼	¾	¼-28	⅞-14	¾-16	2.472	.328	⅞	1⅜	6⅞
	1¾	1⅝	2.000	⅝	1⅞	¾	1		1¼-12	1-14					6⅞
2½	1	1⅞	1.500	½	⅞	¼	¾	¼-28	⅞-14	¾-16	2.472	.328	⅞	1⅜	6⅞
	1¾	1⅝	2.000	⅝	1⅞	¾	1	¼-28	1¼-12	1-14	2.972	.328	1	1⅝	6⅞
	1¾	2	2.375	¾	1½	½	1¼	¼-28	1½-12	1¼-12	3.470	.313	1⅞	1⅞	7⅞
3¼	1¾	1⅝	2.000	⅝	1⅞	¼	⅞	¼-28	1¼-12	1-14	2.972	.328	1	1⅝	7⅞
	1¾	2	2.375	¾	1½	¾	1⅞	¼-28	1½-12	1¼-12	3.470	.313	1⅞	1⅞	7⅞
	2	2½	2.625	⅞	1⅞	¾	1¼	¼-28	1¾-12	1½-12	3.720	.313	1⅞	2	8⅞
4	1¾	2	2.375	¾	1½	¼	1	¼-28	1½-12	1¼-12	3.470	.313	1⅞	1⅞	8⅞
	2	2¼	2.625	⅞	1⅞	¼	1⅞	¼-28	1¾-12	1½-12	3.720	.313	1⅞	2	8⅞
	2½	3	3.125	1	2⅞	¾	1¾	¼-28	2¼-12	1⅞-12	4.252	.313	1¼	2¼	8⅞
5	2	2¼	2.625	⅞	1⅞	¼	1⅞	¼-28	1¾-12	1½-12	3.720	.313	1⅞	2	9⅞
	2½	3	3.125	1	2⅞	¾	1¾	¼-28	2¼-12	1⅞-12	4.252	.313	1¼	2¼	9⅞
	3	3½	3.750	1	2⅞	¾	1¾	¼-28	2¾-12	2¼-12	4.752	.313	1¼	2¼	9⅞
	3½	3½	4.250	1	3	¾	1¾	¼-28	3¼-12	2½-12	5.252	.313	1¼	2¼	9⅞
6	2½	3	3.125	1	2⅞	¼	1¼	¼-28	2¼-12	1⅞-12	4.252	.313	1¼	2¼	10⅞
	3	3½	3.750	1	2⅞	¼	1¼	¼-28	2¾-12	2¼-12	4.752	.313	1¼	2¼	10⅞
	3½	3½	4.250	1	3	¼	1¼	¼-28	3¼-12	2½-12	5.252	.313	1¼	2¼	10⅞
	4	4	4.750	1	3⅞	¼	1¼	⅝-24	3¾-12	3-12	5.939	.610	1¼	2¼	10⅞
7	3	3½	3.750	1	2⅞			¼-28	2¾-12	2¼-12	4.752	.313	1¼	2¼	11¾
	3½	3½	4.250	1	3			¼-28	3¼-12	2½-12	5.252	.313	1¼	2¼	11¾
	4	4	4.750	1	3⅞			⅝-24	3¾-12	3-12	5.939	.610	1¼	2¼	11¾
	4½	4½	5.250	1	3⅞			⅝-24	4¼-12	3¼-12	6.439	.610	1¼	2¼	11¾
	5	5	5.750	1	4¼			⅝-24	4¾-12	3½-12	6.939	.610	1¼	2¼	11¾
8	3½	3½	4.250	1	3			¼-28	3¼-12	2½-12	5.252	.313	1¼	2¼	13
	4	4	4.750	1	3⅞			⅝-24	3¾-12	3-12	5.939	.610	1¼	2¼	13
	4½	4½	5.250	1	3⅞			⅝-24	4¼-12	3¼-12	6.439	.610	1¼	2¼	13
	5	5	5.750	1	4¼			⅝-24	4¾-12	3½-12	6.939	.610	1¼	2¼	13
	5½	5½	6.250	1	4⅝			⅝-24	5¼-12	4-12	7.439	.610	1¼	2¼	13

Note: See page 6 for bore, rod, bolted/retainer bushing availability chart.

Miller HV Series Hydraulic Cylinders

Fixed Clevis
1½" – 8" Bore Cylinders

Model 84-B (NFPA MP1)
Bolted Bushing
Fixed Clevis
(Pivot Pin Included)

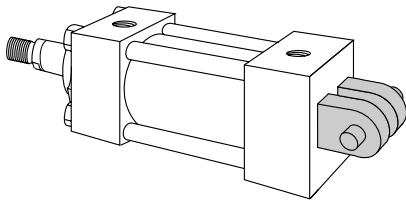

Mounting Dimensions
(See tables on opposite page)

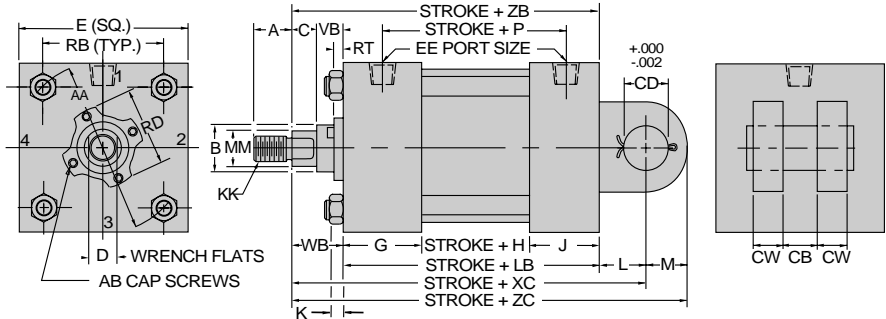

Model 84-R (NFPA MP1)
Square Retainer Held Bushing
Fixed Clevis
(Pivot Pin Included)

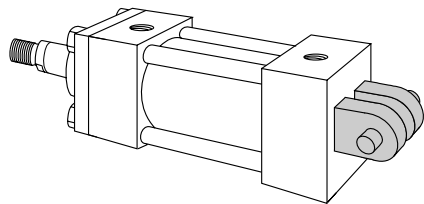

Mounting Dimensions
(See tables on opposite page)

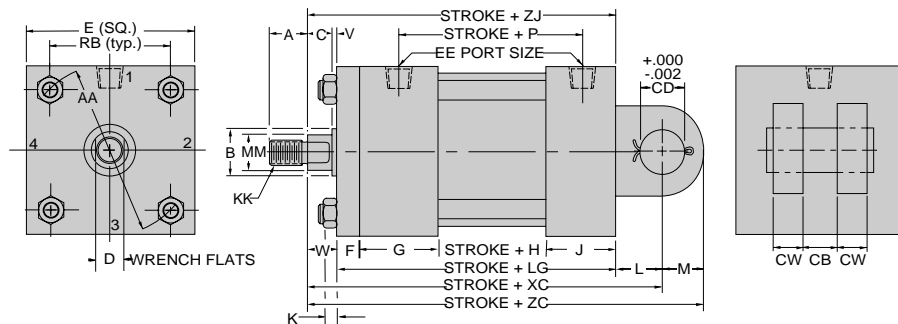

Common Rod End Styles & Dimensions (See page 45 for complete listing of rod end styles)

Style No. 2-Standard
Threaded on Turndown Section

Style No. 4
Short Rod End-Internal Threads

Style No. 5
Threaded Intermediate Male

Style No. 6
Studded Rod End
(Available Thru 2" Rod Diameter)

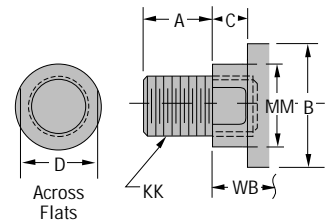
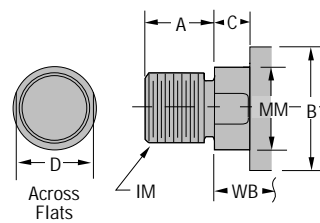
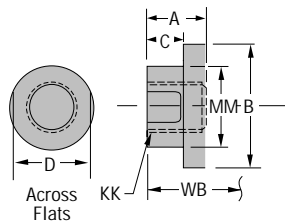
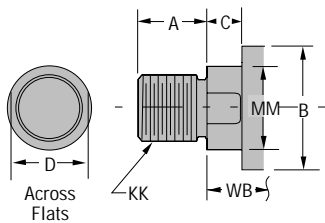

Miller HV Series Hydraulic Cylinders

Fixed Clevis
1 1/2"-8" Bore Cylinders

Cylinder Body Dimensions

Bore Size	E	F	G	J	K	L	M	AA	CB	CD	CW	*EE		RB
												SAE	NPT	
1 1/2	2 1/2	3/8	1 3/4	1 1/2	3/8	3/4	1/2	2.3	3/4	1/2	1/2	-8	1/2	1.63
2	3	5/8	1 3/4	1 1/2	1/16	1 1/4	3/4	2.9	1 1/4	3/4	5/8	-8	1/2	2.05
2 1/2	3 1/2	5/8	1 3/4	1 1/2	1/16	1 1/4	3/4	3.6	1 1/4	3/4	5/8	-8	1/2	2.55
3 1/4	4 1/2	3/4	2	1 3/4	9/16	1 1/2	1	4.6	1 1/2	1	3/4	-12	3/4	3.25
4	5	7/8	2	1 3/4	9/16	2 1/8	1 3/8	5.4	2	1 3/8	1	-12	3/4	3.82
5	6 1/2	7/8	2	1 3/4	13/16	2 1/4	1 3/4	7.0	2 1/2	1 3/4	1 1/4	-12	3/4	4.95
6	7 1/2	1	2 1/4	2 1/4	15/16	2 1/2	2	8.1	2 1/2	2	1 1/4	-16	1	5.73
7	8 1/2		2 3/4	2 3/4	1	3	2 1/2	9.3	3	2 1/2	1 1/2	-20	1 1/4	6.58
8	9 1/2		3	3	1 1/4	3 1/4	2 3/4	10.6	3	3	1 1/2	-24	1 1/2	7.50

* SAE ports are standard, NPT ports are available at no extra charge.

Add Stroke

H	LG	LB	P
1 3/8	4 5/8	5	2 7/8
1 3/8	4 5/8	5 1/4	2 7/8
1 1/2	4 3/4	5 3/8	3
1 3/4	5 1/2	6 1/4	3 1/2
2	5 3/4	6 5/8	3 3/4
2 1/2	6 1/4	7 1/8	4 1/4
2 7/8	7 3/8	8 3/8	4 7/8
3	8 1/2		5 3/8
3 1/2	9 1/2		6 1/8

Rod End Dimensions

Bore Size	Rod Dia (MM)	A	B -.001 to -.003	C	D	V	W	AB	IM Style 5	KK Styles 2,4&6	RD (Max.)	RT	VB	WB
1 1/2	5/8	3/4	1.125	3/8	1/2	1/4	5/8	10-32	1/2-20	7/16-20	1.972	.316	5/8	1
	1	1 1/8	1.500	1/2	7/8	1/2	1		7/8-14	3/4-16				
2	1	1 1/8	1.500	1/2	7/8	1/4	3/4	1 1/4-28	7/8-14	3/4-16	2.472	.328	7/8	1 3/8
	1 3/8	1 5/8	2.000	5/8	1 1/8	3/8	1		1 1/4-12	1-14				
2 1/2	1	1 1/8	1.500	1/2	7/8	1/4	3/4	1 1/4-28	7/8-14	3/4-16	2.472	.328	7/8	1 3/8
	1 3/8	1 5/8	2.000	5/8	1 1/8	3/8	1	1 1/4-28	1 1/4-12	1-14	2.972	.328	1	1 5/8
	1 3/4	2	2.375	3/4	1 1/2	1/2	1 1/4	1 1/4-28	1 1/2-12	1 1/4-12	3.470	.313	1 1/8	1 7/8
3 1/4	1 3/8	1 5/8	2.000	5/8	1 1/8	1/4	7/8	1 1/4-28	1 1/4-12	1-14	2.972	.328	1	1 5/8
	1 3/4	2	2.375	3/4	1 1/2	3/8	1 1/8	1 1/4-28	1 1/2-12	1 1/4-12	3.470	.313	1 1/8	1 7/8
	2	2 1/4	2.625	7/8	1 11/16	3/8	1 1/4	1 1/4-28	1 3/4-12	1 1/2-12	3.720	.313	1 1/8	2
4	1 3/4	2	2.375	3/4	1 1/2	1/4	1	1 1/4-28	1 1/2-12	1 1/4-12	3.470	.313	1 1/8	1 7/8
	2	2 1/4	2.625	7/8	1 11/16	1/4	1 1/8	1 1/4-28	1 3/4-12	1 1/2-12	3.720	.313	1 1/8	2
	2 1/2	3	3.125	1	2 1/16	3/8	1 3/8	1 1/4-28	2 1/4-12	1 7/8-12	4.252	.313	1 1/4	2 1/4
5	2	2 1/4	2.625	7/8	1 11/16	1/4	1 1/8	1 1/4-28	1 3/4-12	1 1/2-12	3.720	.313	1 1/8	2
	2 1/2	3	3.125	1	2 1/16	3/8	1 3/8	1 1/4-28	2 1/4-12	1 7/8-12	4.252	.313	1 1/4	2 1/4
	3	3 1/2	3.750	1	2 5/8	3/8	1 3/8	1 1/4-28	2 3/4-12	2 1/4-12	4.752	.313	1 1/4	2 1/4
	3 1/2	3 1/2	4.250	1	3	3/8	1 3/8	1 1/4-28	3 1/4-12	2 1/2-12	5.252	.313	1 1/4	2 1/4
6	2 1/2	3	3.125	1	2 1/16	1/4	1 1/4	1 1/4-28	2 1/4-12	1 7/8-12	4.252	.313	1 1/4	2 1/4
	3	3 1/2	3.750	1	2 5/8	1/4	1 1/4	1 1/4-28	2 3/4-12	2 1/4-12	4.752	.313	1 1/4	2 1/4
	3 1/2	3 1/2	4.250	1	3	1/4	1 1/4	1 1/4-28	3 1/4-12	2 1/2-12	5.252	.313	1 1/4	2 1/4
	4	4	4.750	1	3 3/8	1/4	1 1/4	5/16-24	3 1/4-12	3-12	5.939	.610	1 1/4	2 1/4
7	3	3 1/2	3.750	1	2 5/8			1 1/4-28	2 3/4-12	2 1/4-12	4.752	.313	1 1/4	2 1/4
	3 1/2	3 1/2	4.250	1	3			1 1/4-28	3 1/4-12	2 1/2-12	5.252	.313	1 1/4	2 1/4
	4	4	4.750	1	3 3/8			5/16-24	3 1/4-12	3-12	5.939	.610	1 1/4	2 1/4
	4 1/2	4 1/2	5.250	1	3 7/8			5/16-24	4 1/4-12	3 1/4-12	6.439	.610	1 1/4	2 1/4
	5	5	5.750	1	4 1/4			5/16-24	4 3/4-12	3 1/2-12	6.939	.610	1 1/4	2 1/4
8	3 1/2	3 1/2	4.250	1	3			1 1/4-28	3 1/4-12	2 1/2-12	5.252	.313	1 1/4	2 1/4
	4	4	4.750	1	3 3/8			5/16-24	3 3/4-12	3-12	5.939	.610	1 1/4	2 1/4
	4 1/2	4 1/2	5.250	1	3 7/8			5/16-24	4 1/4-12	3 1/4-12	6.439	.610	1 1/4	2 1/4
	5	5	5.750	1	4 1/4			5/16-24	4 3/4-12	3 1/2-12	6.939	.610	1 1/4	2 1/4
	5 1/2	5 1/2	6.250	1	4 5/8			5/16-24	5 1/4-12	4-12	7.439	.610	1 1/4	2 1/4

Note: See page 6 for bore, rod, bolted/retainer bushing availability chart. See page 46 for Rod End Accessories.

Add Stroke

XC	ZB	ZC
6 3/8	6	6 7/8
6 3/4	6 3/8	7 1/4
7 1/4	6 1/16	8
7 1/2	6 11/16	8 1/4
7 3/8	6 9/16	8 1/8
7 5/8	6 13/16	8 3/8
7 7/8	7 1/16	8 5/8
8 5/8	7 11/16	9 5/8
8 7/8	7 15/16	9 7/8
9	8 1/16	10
9 3/4	8 3/16	11 1/8
9 7/8	8 5/16	11 1/4
10 1/8	8 9/16	11 1/2
10 1/2	9 1/16	12 1/4
10 3/4	9 5/16	12 1/2
10 3/4	9 5/16	12 1/2
10 3/4	9 5/16	12 1/2
12 1/8	10 9/16	14 1/8
12 1/8	10 9/16	14 1/8
12 1/8	10 9/16	14 1/8
12 1/8	10 9/16	14 1/8
13 3/4	11 3/4	16 1/4
13 3/4	11 3/4	16 1/4
13 3/4	11 3/4	16 1/4
13 3/4	11 3/4	16 1/4
15	13	17 3/4
15	13	17 3/4
15	13	17 3/4
15	13	17 3/4

Miller HV Series Hydraulic Cylinders

Detachable Clevis
1 1/2" - 5" Bore Cylinders

Model 86-B (NFPA MP2)
Bolted Bushing
Detachable Clevis
(Pivot Pin Included)

Mounting Dimensions
(See tables on opposite page)

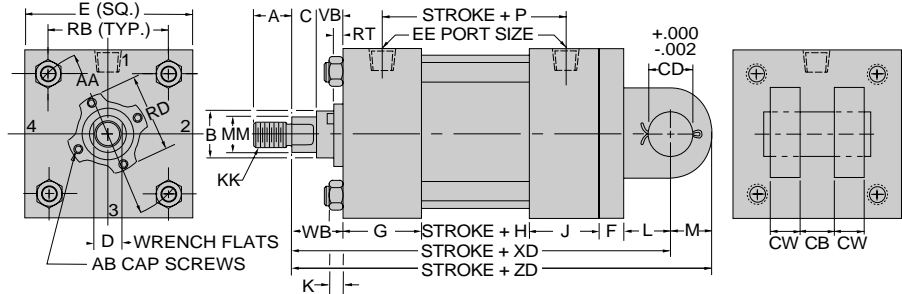
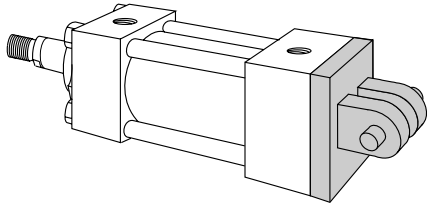

Model 86-R (NFPA MP2)
Square Retainer Held Bushing
Detachable Clevis
(Pivot Pin Included)

Mounting Dimensions
(See tables on opposite page)

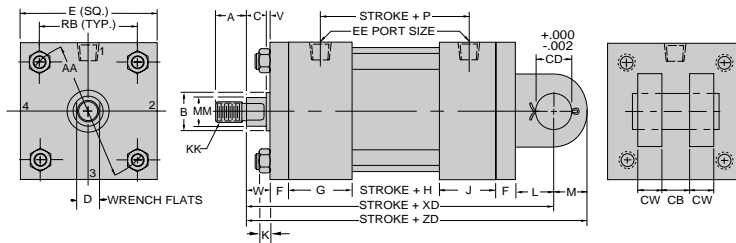
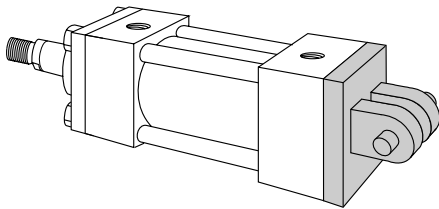

Common Rod End Styles & Dimensions (See page 45 for complete listing of rod end styles)

Style No. 2-Standard
Threaded on Turndown Section

Style No. 4
Short Rod End-Internal Threads

Style No. 5
Threaded Intermediate Male

Style No. 6
Studded Rod End
(Available Thru 2" Rod Diameter)

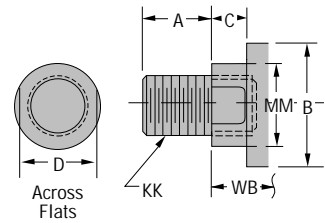
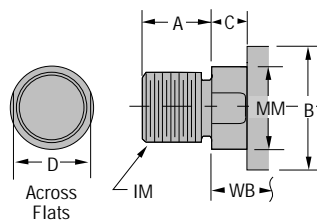
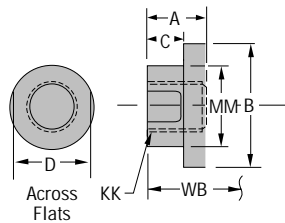
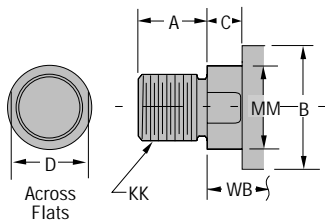

Miller HV Series Hydraulic Cylinders

Detachable Clevis
1 1/2" – 5" Bore Cylinders

Cylinder Body Dimensions

Bore Size	E	F	G	J	K	L	M	AA	CB	CD	CW	*EE		RB
												SAE	NPT	
1 1/2	2 1/2	3/8	1 3/4	1 1/2	3/8	3/4	1/2	2.3	3/4	1/2	1/2	-8	1/2	1.63
2	3	5/8	1 3/4	1 1/2	7/16	1 1/4	3/4	2.9	1 1/4	3/4	5/8	-8	1/2	2.05
2 1/2	3 1/2	5/8	1 3/4	1 1/2	7/16	1 1/4	3/4	3.6	1 1/4	3/4	5/8	-8	1/2	2.55
3 1/4	4 1/2	3/4	2	1 3/4	9/16	1 1/2	1	4.6	1 1/2	1	3/4	-12	3/4	3.25
4	5	7/8	2	1 3/4	9/16	2 1/8	1 3/8	5.4	2	1 3/8	1	-12	3/4	3.82
5	6 1/2	7/8	2	1 3/4	13/16	2 1/4	1 3/4	7.0	2 1/2	1 3/4	1 1/4	-12	3/4	4.95

Add Stroke

H	P
1 3/8	2 7/8
1 3/8	2 7/8
1 1/2	3
1 3/4	3 1/2
2	3 3/4
2 1/2	4 1/4

* SAE ports are standard, NPT ports are available at no extra charge.

Rod End Dimensions

Bore Size	Rod Dia (MM)	A	B -.001 to -.003	C	D	V	W	AB	IM Style 5	KK Styles 2,4&6	RD (Max.)	RT	VB	WB
1 1/2	5/8	3/4	1.125	3/8	1/2	1/4	5/8	10-32	1/2-20	7/16-20	1.972	.316	5/8	1
	1	1 1/8	1.500	7/2	7/8	1/2	1		7/8-14	3/4-16				
2	1	1 1/8	1.500	1/2	7/8	1/4	3/4	1/4-28	7/8-14	3/4-16	2.472	.328	7/8	1 3/8
	1 3/8	1 5/8	2.000	5/8	1 1/8	3/8	1		1 1/4-12	1-14				
2 1/2	1	1 1/8	1.500	1/2	7/8	1/4	3/4	1/4-28	7/8-14	3/4-16	2.472	.328	7/8	1 3/8
	1 3/8	1 5/8	2.000	5/8	1 1/8	3/8	1	1/4-28	1 1/4-12	1-14	2.972	.328	1	1 5/8
	1 3/4	2	2.375	3/4	1 1/2	1/2	1 1/4	1/4-28	1 1/2-12	1 1/4-12	3.470	.313	1 1/8	1 7/8
3 1/4	1 3/8	1 5/8	2.000	5/8	1 1/8	1/4	7/8	1/4-28	1 1/4-12	1-14	2.972	.328	1	1 5/8
	1 3/4	2	2.375	3/4	1 1/2	3/8	1 1/8	1/4-28	1 1/2-12	1 1/4-12	3.470	.313	1 1/8	1 7/8
	2	2 1/4	2.625	7/8	1 11/16	3/8	1 1/4	1/4-28	1 3/4-12	1 1/2-12	3.720	.313	1 1/8	2
4	1 3/4	2	2.375	3/4	1 1/2	1/4	1	1/4-28	1 1/2-12	1 1/4-12	3.470	.313	1 1/8	1 7/8
	2	2 1/4	2.625	7/8	1 11/16	1/4	1 1/8	1/4-28	1 3/4-12	1 1/2-12	3.720	.313	1 1/8	2
	2 1/2	3	3.125	1	2 1/16	3/8	1 3/8	1/4-28	2 1/4-12	1 7/8-12	4.252	.313	1 1/4	2 1/4
5	2	2 1/4	2.625	7/8	1 11/16	1/4	1 1/8	1/4-28	1 3/4-12	1 1/2-12	3.720	.313	1 1/8	2
	2 1/2	3	3.125	1	2 1/16	3/8	1 3/8	1/4-28	2 1/4-12	1 7/8-12	4.252	.313	1 1/4	2 1/4
	3	3 1/2	3.750	1	2 5/8	3/8	1 3/8	1/4-28	2 3/4-12	2 1/4-12	4.752	.313	1 1/4	2 1/4
	3 1/2	3 1/2	4.250	1	3	3/8	1 3/8	1/4-28	3 1/4-12	2 1/2-12	5.252	.313	1 1/4	2 1/4

Add Stroke

XD	ZD
6 3/4	7 1/4
7 1/8	7 5/8
7 7/8	8 5/8
8 1/8	8 7/8
8	8 3/4
8 1/4	9
8 1/2	9 1/4
9 3/8	10 3/8
9 5/8	10 5/8
9 3/4	10 3/4
10 5/8	12
10 3/4	12 1/8
11	12 3/8
11 3/8	13 1/8
11 5/8	13 1/8
11 5/8	13 1/8
11 5/8	13 1/8

Note: See page 6 for bore, rod, bolted/retainer bushing availability chart. See page 46 for Rod End Accessories.

Miller HV Series Hydraulic Cylinders

Rear Eye
1½" – 8" Bore Cylinders

Model 90-B (NFPA MP3)
Bolted Bushing
Rear Eye
(Pivot Pin Included)

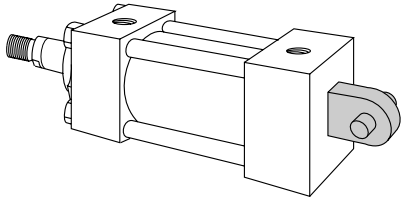

Note: See page 46 for pivot pin dimensions.

Mounting Dimensions
(See tables on opposite page)

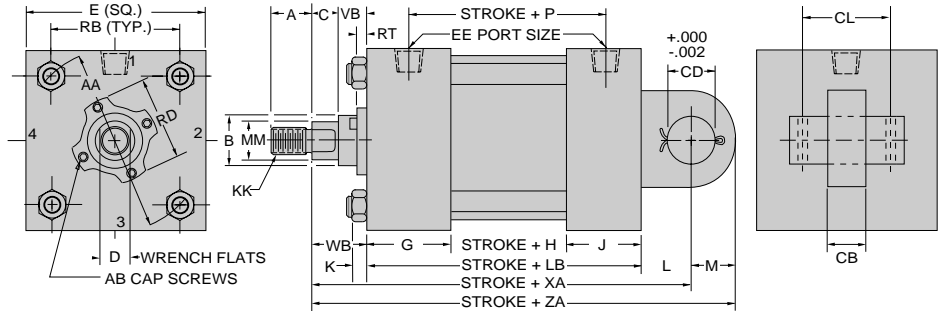

Model 90-R (NFPA MP3)
Square Retainer Held Bushing
Rear Eye
(Pivot Pin Included)

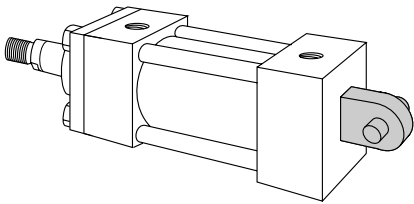

Note: See page 46 for pivot pin dimensions.

Mounting Dimensions
(See tables on opposite page)

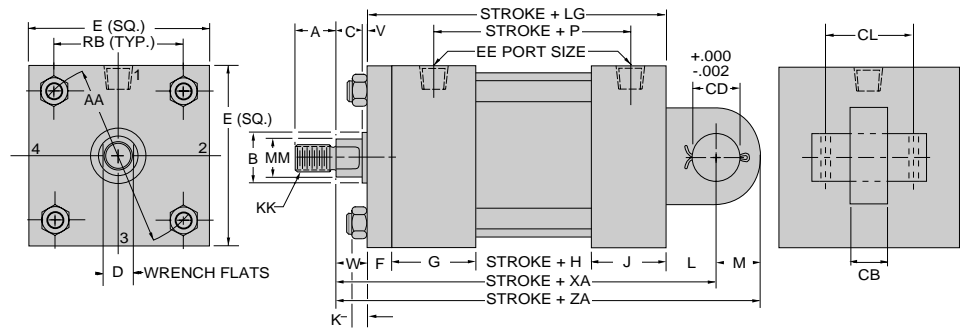

Common Rod End Styles & Dimensions (See page 45 for complete listing of rod end styles)

Style No. 2-Standard
Threaded on Turndown Section

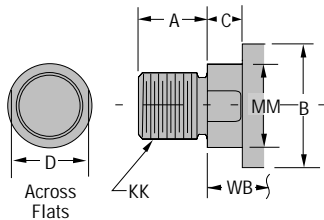

Style No. 4
Short Rod End-Internal Threads

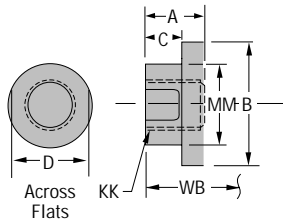

Style No. 5
Threaded Intermediate Male

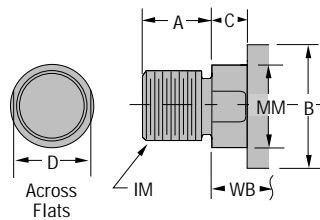

Style No. 6
Studded Rod End
(Available Thru 2" Rod Diameter)

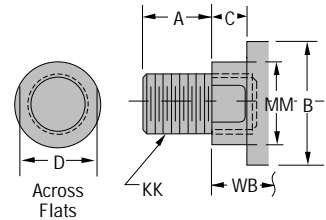

Miller HV Series Hydraulic Cylinders

Rear Eye
1 1/2" – 8" Bore Cylinders

Cylinder Body Dimensions

Bore Size	E	F	G	J	K	L	M	AA	CB	CD	CL	*EE		RB
												SAE	NPT	
1 1/2	2 1/2	3/8	1 3/4	1 1/2	3/8	3/4	1/2	2.3	3/4	1/2	1.83	-8	1/2	1.63
2	3	5/8	1 3/4	1 1/2	7/16	1 1/4	3/4	2.9	1 1/4	3/4	2.58	-8	1/2	2.05
2 1/2	3 1/2	5/8	1 3/4	1 1/2	7/16	1 1/4	3/4	3.6	1 1/4	3/4	2.58	-8	1/2	2.55
3 1/4	4 1/2	3/4	2	1 3/4	9/16	1 1/2	1	4.6	1 1/2	1	3.08	-12	3/4	3.25
4	5	7/8	2	1 3/4	9/16	2 1/8	1 3/8	5.4	2	1 3/8	4.08	-12	3/4	3.82
5	6 1/2	7/8	2	1 3/4	13/16	2 1/4	1 3/4	7.0	2 1/2	1 3/4	5.08	-12	3/4	4.95
6	7 1/2	1	2 1/4	2 1/4	15/16	2 1/2	2	8.1	2 1/2	2	5.08	-16	1	5.73
7	8 1/2		2 3/4	2 3/4	1	3	2 1/2	9.3	3	2 1/2	6.09	-20	1 1/4	6.58
8	9 1/2		3	3	1 1/4	3 1/4	2 3/4	10.6	3	3	6.09	-24	1 1/2	7.50

* SAE ports are standard, NPT ports are available at no extra charge.

Add Stroke

H	LB	LG	P
1 3/8	4 5/8	5	2 7/8
1 3/8	4 5/8	5 1/4	2 7/8
1 1/2	4 3/4	5 3/8	3
1 3/4	5 1/2	6 1/4	3 1/2
2	5 3/4	6 5/8	3 3/4
2 1/2	6 1/4	7 1/8	4 1/4
2 7/8	7 3/8	8 3/8	4 7/8
3	8 1/2		5 3/8
3 1/2	9 1/2		6 1/8

Rod End Dimensions

Bore Size	Rod Dia (MM)	A	B -.001 to -.003	C	D	V	W	AB	IM Style 5	KK Styles 2,4&6	RD (Max.)	RT	VB	WB
	1	1 1/8	1.500	1/2	7/8	1/2	1		7/8-14	3/4-16				
2	1	1 1/8	1.500	1/2	7/8	1/4	3/4	1 1/4-28	7/8-14	3/4-16	2.472	.328	7/8	1 3/8
	1 3/8	1 5/8	2.000	5/8	1 1/8	3/8	1		1 1/4-12	1-14				
2 1/2	1	1 1/8	1.500	1/2	7/8	1/4	3/4	1 1/4-28	7/8-14	3/4-16	2.472	.328	7/8	1 3/8
	1 3/8	1 5/8	2.000	5/8	1 1/8	3/8	1	1 1/4-28	1 1/4-12	1-14	2.972	.328	1	1 5/8
	1 3/4	2	2.375	3/4	1 1/2	1/2	1 1/4	1 1/4-28	1 1/2-12	1 1/4-12	3.470	.313	1 1/8	1 7/8
3 1/4	1 3/8	1 5/8	2.000	5/8	1 1/8	1/4	7/8	1 1/4-28	1 1/4-12	1-14	2.972	.328	1	1 5/8
	1 3/4	2	2.375	3/4	1 1/2	3/8	1 1/8	1 1/4-28	1 1/2-12	1 1/4-12	3.470	.313	1 1/8	1 7/8
	2	2 1/4	2.625	7/8	1 11/16	3/8	1 1/4	1 1/4-28	1 3/4-12	1 1/2-12	3.720	.313	1 1/8	2
4	1 3/4	2	2.375	3/4	1 1/2	1/4	1	1 1/4-28	1 1/2-12	1 1/4-12	3.470	.313	1 1/8	1 7/8
	2	2 1/4	2.625	7/8	1 11/16	1/4	1 1/8	1 1/4-28	1 3/4-12	1 1/2-12	3.720	.313	1 1/8	2
	2 1/2	3	3.125	1	2 1/16	3/8	1 3/8	1 1/4-28	2 1/4-12	1 7/8-12	4.252	.313	1 1/4	2 1/4
5	2	2 1/4	2.625	7/8	1 11/16	1/4	1 1/8	1 1/4-28	1 3/4-12	1 1/2-12	3.720	.313	1 1/8	2
	2 1/2	3	3.125	1	2 1/16	3/8	1 3/8	1 1/4-28	2 1/4-12	1 7/8-12	4.252	.313	1 1/4	2 1/4
	3	3 1/2	3.750	1	2 5/8	3/8	1 3/8	1 1/4-28	2 3/4-12	2 1/4-12	4.752	.313	1 1/4	2 1/4
	3 1/2	3 1/2	4.250	1	3	3/8	1 3/8	1 1/4-28	3 1/4-12	2 1/2-12	5.252	.313	1 1/4	2 1/4
6	2 1/2	3	3.125	1	2 1/16	1/4	1 1/4	1 1/4-28	2 1/4-12	1 7/8-12	4.252	.313	1 1/4	2 1/4
	3	3 1/2	3.750	1	2 5/8	1/4	1 1/4	1 1/4-28	2 3/4-12	2 1/4-12	4.752	.313	1 1/4	2 1/4
	3 1/2	3 1/2	4.250	1	3	1/4	1 1/4	1 1/4-28	3 1/4-12	2 1/2-12	5.252	.313	1 1/4	2 1/4
	4	4	4.750	1	3 3/8	1/4	1 1/4	5/16-24	3 1/4-12	3-12	5.939	.610	1 1/4	2 1/4
7	3	3 1/2	3.750	1	2 5/8			1 1/4-28	2 3/4-12	2 1/4-12	4.752	.313	1 1/4	2 1/4
	3 1/2	3 1/2	4.250	1	3			1 1/4-28	3 1/4-12	2 1/2-12	5.252	.313	1 1/4	2 1/4
	4	4	4.750	1	3 3/8			5/16-24	3 1/4-12	3-12	5.939	.610	1 1/4	2 1/4
	4 1/2	4 1/2	5.250	1	3 7/8			5/16-24	4 1/4-12	3 1/4-12	6.439	.610	1 1/4	2 1/4
	5	5	5.750	1	4 1/4			5/16-24	4 3/4-12	3 1/2-12	6.939	.610	1 1/4	2 1/4
8	3 1/2	3 1/2	4.250	1	3			1 1/4-28	3 1/4-12	2 1/2-12	5.252	.313	1 1/4	2 1/4
	4	4	4.750	1	3 3/8			5/16-24	3 3/4-12	3-12	5.939	.610	1 1/4	2 1/4
	4 1/2	4 1/2	5.250	1	3 7/8			5/16-24	4 1/4-12	3 1/4-12	6.439	.610	1 1/4	2 1/4
	5	5	5.750	1	4 1/4			5/16-24	4 3/4-12	3 1/2-12	6.939	.610	1 1/4	2 1/4
	5 1/2	5 1/2	6.250	1	4 5/8			5/16-24	5 1/4-12	4-12	7.439	.610	1 1/4	2 1/4

Note: See page 6 for bore, rod, bolted/retainer bushing compatibility chart.

See page 46 for Rod End Accessories.

Add Stroke

XA	ZA
6 3/8	6 7/8
6 3/4	7 1/4
7 1/4	8
7 1/2	8 1/4
7 3/8	8 1/8
7 5/8	8 3/8
7 7/8	8 5/8
8 5/8	9 5/8
8 7/8	9 7/8
9	10
9 3/4	11 1/8
9 7/8	11 1/4
10 1/8	11 1/2
10 1/2	12 1/4
10 3/4	12 1/2
10 3/4	12 1/2
10 3/4	12 1/2
12 1/8	14 1/8
12 1/8	14 1/8
12 1/8	14 1/8
13 3/4	16 1/4
13 3/4	16 1/4
13 3/4	16 1/4
13 3/4	16 1/4
15	17 3/4
15	17 3/4
15	17 3/4
15	17 3/4

Miller HV Series Hydraulic Cylinders

Rear Eye Spherical Bearing 1 1/2" – 6" Bore Cylinders

Model 94-B
Bolted Bushing
Rear Eye Spherical Bearing
(Pivot Pin Included)

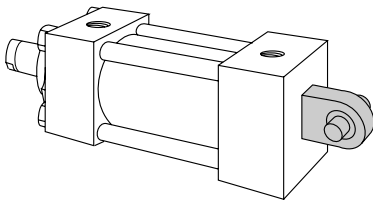

Mounting Dimensions
(See tables on opposite page)

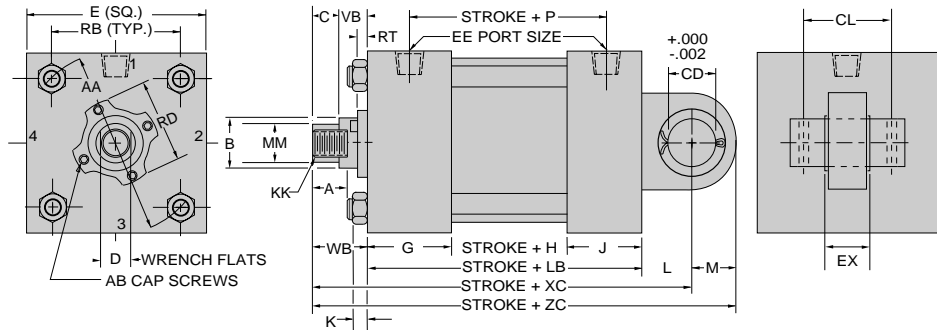

Note: See page 46 for pivot pin dimensions.
Model 94 should use Spherical Rod Eye on Rod End. See below.
See Maximum Pressure Rating below.

Model 94-R
Square Retainer Held Bushing
Rear Eye Spherical Bearing
(Pivot Pin Included)

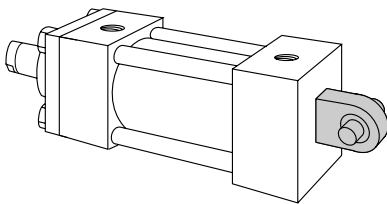

Mounting Dimensions
(See tables on opposite page)

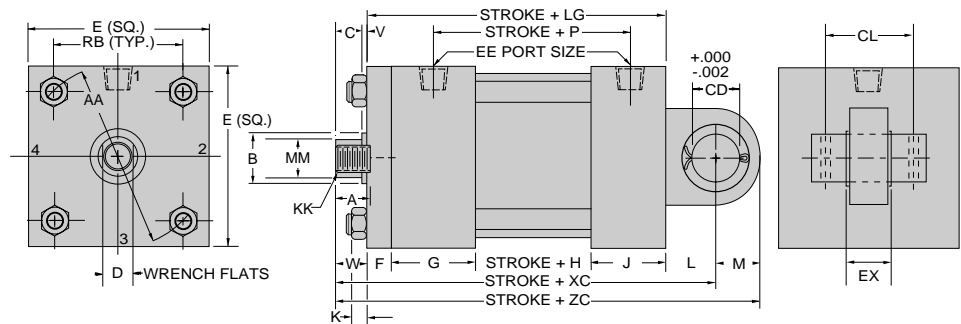

Note: See page 46 for pivot pin dimensions.
Model 94 should use Spherical Rod Eye on Rod End. See below.
See Maximum Pressure Rating below.

Maximum Pressure Rating

Bore	Max Press (psi)
1 1/2	1520
2	1930
2 1/2	1230
3 1/4	1300
4	1600
5	1680
6	1520

Rod End Style

Style No. 4
Short Rod End-Internal Threads

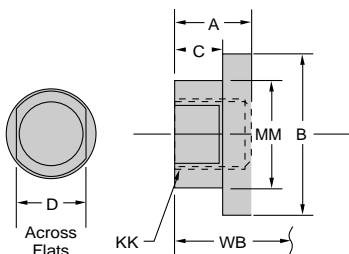

Spherical Rod Eye

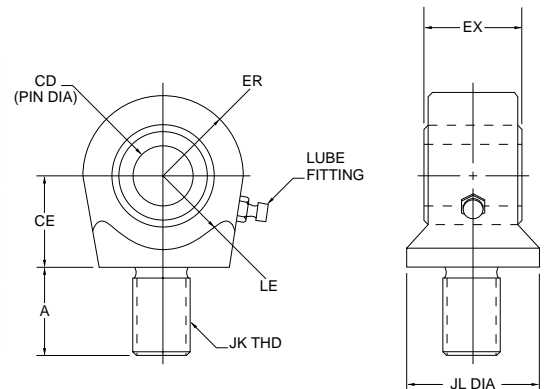

Part No.	CD ± .0000 / .0005	A	CE	EX	ER	LE	JK	JL	MAX. LOAD CAPACITY (lbs)
057-SRE02-00063	.5000	.688	.875	.438	.875	.750	7/16-20	.875	2,600
057-SRE02-00100	.7500	1.000	1.250	.656	1.250	1.063	3/4-16	1.313	8,650
057-SRE02-00138	1.0000	1.500	1.875	.875	1.375	1.438	1-14	1.500	15,000
057-SRE02-00175	1.3750	2.000	2.125	1.188	1.813	1.875	1 1/4-12	2.000	27,000
057-SRE02-00200	1.7500	2.125	2.500	1.531	2.188	2.125	1 1/2-12	2.250	33,000
057-SRE02-00250	2.0000	2.875	2.750	1.750	2.625	2.500	1 7/8-12	2.750	54,000

Miller HV Series Hydraulic Cylinders

Spherical Bearing 1 1/2" - 6" Bore Cylinders

Cylinder Body Dimensions

Bore	E Size	F	G	J	K	L	M	AA	EX	CD	CL	*EE		RB
												SAE	NPT	
1 1/2	2 1/2	3/8	1 3/4	1 1/2	3/8	3/4	3/4	2.3	7/16	1/2	1.83	-8	1/2	1.63
2	3	5/8	1 3/4	1 1/2	7/16	1 1/4	1	2.9	21/32	3/4	2.58	-8	1/2	2.05
2 1/2	3 1/2	5/8	1 3/4	1 1/2	7/16	1 1/4	1	3.6	21/32	3/4	2.58	-8	1/2	2.55
3 1/4	4 1/2	3/4	2	1 3/4	9/16	1 1/2	1 1/4	4.6	7/8	1	3.08	-12	3/4	3.25
4	5	7/8	2	1 3/4	9/16	2 1/8	1 7/8	5.4	1 3/16	1 3/8	4.08	-12	3/4	3.82
5	6 1/2	7/8	2	1 3/4	1 3/16	2 1/4	2 1/2	7.0	1 17/32	1 3/4	5.08	-12	3/4	4.95
6	7 1/2	1	2 1/4	2 1/4	1 5/16	2 1/2	2 1/2	8.1	1 3/4	2	5.08	-16	1	5.73

* SAE ports are standard, NPT ports are available at no extra charge.

Add Stroke

H	LB	LG	P
1 3/8	4 5/8	5	2 7/8
1 3/8	4 5/8	5 1/4	2 7/8
1 1/2	4 3/4	5 3/8	3
1 3/4	5 1/2	6 1/4	3 1/2
2	5 3/4	6 5/8	3 3/4
2 1/2	6 1/4	7 1/8	4 1/4
2 7/8	7 3/8	8 3/8	4 7/8

Rod End Dimensions

Bore Size	Rod Dia (MM)	A	B -.001 to -.003	C	D	V	W	AB	KK Styles 4	RD (Max.)	RT	VB	WB
1 1/2	5/8	3/4	1.125	3/8	1/2	1/4	5/8	10-32	7/16-20	1.972	.316	5/8	1
	1	1 1/8	1.500	1/2	7/8	1/2	1		3/4-16				
2	1	1 1/8	1.500	1/2	7/8	1/4	3/4	1/4-28	3/4-16	2.472	.328	7/8	1 3/8
	1 3/8	1 5/8	2.000	5/8	1 1/8	3/8	1		1-14				
2 1/2	1	1 1/8	1.500	1/2	7/8	1/4	3/4	1/4-28	3/4-16	2.472	.328	7/8	1 3/8
	1 3/8	1 5/8	2.000	5/8	1 1/8	3/8	1	1/4-28	1-14	2.972	.328	1	1 5/8
	1 3/4	2	2.375	3/4	1 1/2	1/2	1 1/4	1/4-28	1 1/4-12	3.470	.313	1 1/8	1 7/8
3 1/4	1 3/8	1 5/8	2.000	5/8	1 1/8	1/4	7/8	1/4-28	1-14	2.972	.328	1	1 5/8
	1 3/4	2	2.375	3/4	1 1/2	3/8	1 1/8	1/4-28	1 1/4-12	3.470	.313	1 1/8	1 7/8
	2	2 1/4	2.625	7/8	1 11/16	3/8	1 1/4	1/4-28	1 1/2-12	3.720	.313	1 1/8	2
4	1 3/4	2	2.375	3/4	1 1/2	1/4	1	1/4-28	1 1/4-12	3.470	.313	1 1/8	1 7/8
	2	2 1/4	2.625	7/8	1 11/16	1/4	1 1/8	1/4-28	1 1/2-12	3.720	.313	1 1/8	2
	2 1/2	3	3.125	1	2 1/16	3/8	1 3/8	1/4-28	1 7/8-12	4.252	.313	1 1/4	2 1/4
5	2	2 1/4	2.625	7/8	1 11/16	1/4	1 1/8	1/4-28	1 1/2-12	3.720	.313	1 1/8	2
	2 1/2	3	3.125	1	2 1/16	3/8	1 3/8	1/4-28	1 7/8-12	4.252	.313	1 1/4	2 1/4
	3	3 1/2	3.750	1	2 5/8	3/8	1 3/8	1/4-28	2 1/4-12	4.752	.313	1 1/4	2 1/4
	3 1/2	3 1/2	4.250	1	3	3/8	1 3/8	1/4-28	2 1/2-12	5.252	.313	1 1/4	2 1/4
6	2 1/2	3	3.125	1	2 1/16	1/4	1 1/4	1/4-28	1 7/8-12	4.252	.313	1 1/4	2 1/4
	3	3 1/2	3.750	1	2 5/8	1/4	1 1/4	1/4-28	2 1/4-12	4.752	.313	1 1/4	2 1/4
	3 1/2	3 1/2	4.250	1	3	1/4	1 1/4	1/4-28	2 1/2-12	5.252	.313	1 1/4	2 1/4
	4	4	4.750	1	3 3/8	1/4	1 1/4	5/16-24	3-12	5.939	.610	1 1/4	2 1/4

Note: See page 6 for bore, rod, bolted/retainer bushing compatibility chart.

Add Stroke

XC	ZC
6 3/8	7 1/8
6 3/4	7 1/2
7 1/4	8 1/4
7 1/2	8 1/2
7 3/8	8 3/8
7 5/8	8 5/8
7 7/8	8 7/8
8 5/8	9 7/8
8 7/8	10 1/8
9	10 1/4
9 3/4	11 5/8
9 7/8	11 3/4
10 1/8	12
10 1/2	13
10 3/4	13 1/4
10 3/4	13 1/4
10 3/4	13 1/4
12 1/8	14 5/8
12 1/8	14 5/8
12 1/8	14 5/8

Clevis Bracket for Spherical Rod Eye

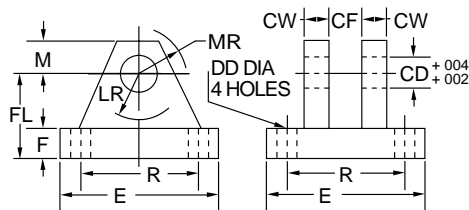

Pivot Pin for Spherical Eye

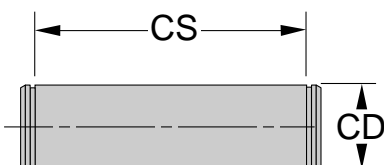

Note: Maximum Cylinder Pressure Ratings for Model 94 Cylinders are shown on page 42. Load capacities of accessories or Model 94 cylinders at Maximum Pressure Ratings should not be exceeded.

Part No.	057-SMB01 50	057-SMB01 75	057-SMB01 100	057-SMB01 138	057-SMB01 175	057-SMB01 200
CD	1/2	3/4	1	1 3/8	1 3/4	2
CF	7/16	21/32	7/8	1 3/16	1 17/32	1 3/4
CW	1/2	5/8	3/4	1	1 1/4	1 1/2
DD	1 3/32	1 7/32	1 11/32	2 1/32	2 9/32	2 29/32
E	3	3 3/4	5 1/2	6 1/2	8 1/2	10 5/8
F	1/2	5/8	3/4	7/8	1 1/4	1 1/2
FL	1 1/2	2	2 1/2	3 1/2	4 1/2	5
LR	1 5/16	1 3/8	1 11/16	2 7/16	2 7/8	3 5/16
M	1/2	7/8	1	1 3/8	1 3/4	2
MR	5/8	1	1 3/16	1 3/4	2 1/16	2 3/8
R	2.05	2.76	4.10	4.95	6.58	7.92
Load Capacity	2,600	8,650	15,000	27,000	33,000	54,000

Part No.	057-PP005 -050	057-PP005 -075	057-PP005 -100	057-PP005 -138	057-PP005 -175	057-PP005 -200
CD	1/2	3/4	1	1 3/8	1 3/4	2
CS	1 9/16	2 1/32	2 1/2	3 5/16	4 7/32	4 15/16
Load (lb) Capacity	4,900	11,000	19,600	37,000	60,000	78,500

Miller HV Series Hydraulic Cylinders

Bolted Bushing Double Rod End

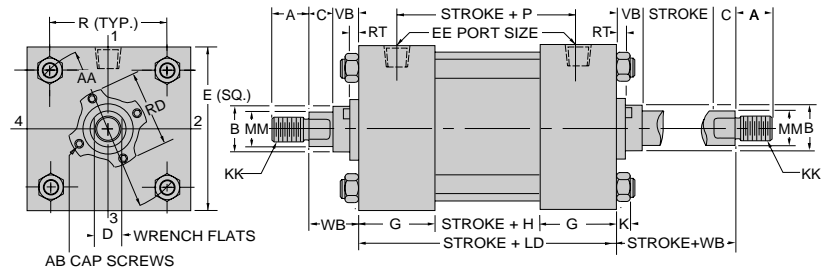
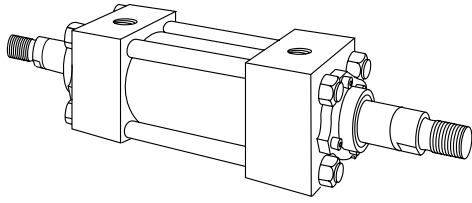

Note: To determine the dimensions for your Double Rod End cylinder:

- Refer to the Single Rod mounting style you are selecting on the preceding pages.
- Select the necessary dimensions which pertain to your mounting style.
- Return to this page and use these dimensions to finish sizing your cylinder.

Note: Double Rod End cylinders have head (G dimensions) at both ends and LD replaces the LB dimension. On Double Rod End cylinders where the rod end styles differ, be sure to clearly state which rod end is which (port position 1 is standard).

Square Retainer Held Bushing Double Rod End

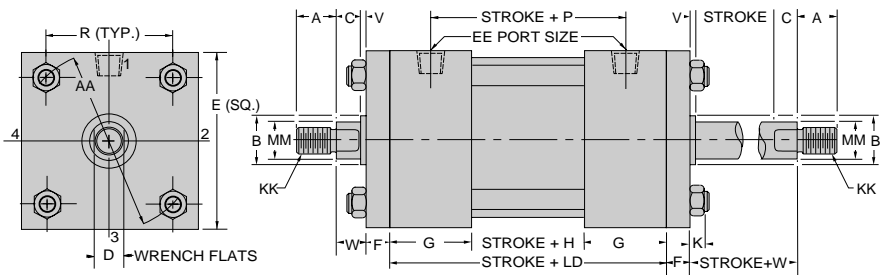
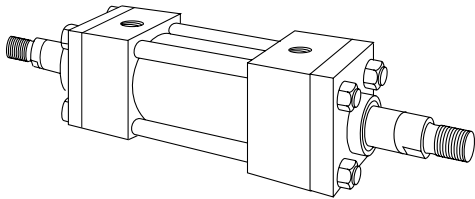

Note: To determine the dimensions for your Double Rod End cylinder:

- Refer to the Single Rod mounting style you are selecting on the preceding pages.
- Select the necessary dimensions which pertain to your mounting style.
- Return to this page and use these dimensions to finish sizing your cylinder.

Note: Double Rod End cylinders have head (G dimensions) at both ends and LD replaces the LB dimension. On Double Rod End cylinders where the rod end styles differ, be sure to clearly state which rod end is on which cylinder end. (port position 1 is standard).

Common Rod End Styles & Dimensions (See page 45 for complete listing of rod end styles)

Style No. 2-Standard
Threaded on Turndown Section

Style No. 4
Short Rod End-Internal Threads

Style No. 5
Threaded Intermediate Male

Style No. 6
Studded Rod End
(Available Thru 2" Rod Diameter)

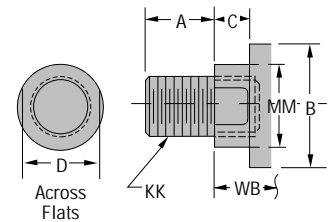
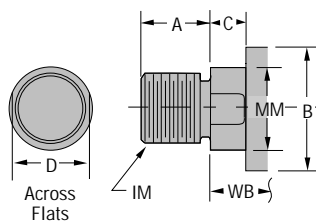
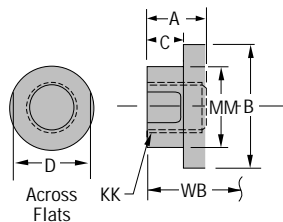
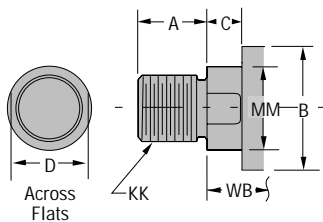

Miller HV Series Hydraulic Cylinders

Rod End Styles and Dimensions

Rod End Styles

Rod End Style 2 is the standard rod end on Miller Fluid Power cylinders and will be furnished unless otherwise specified.

The rod end styles shown on this page represent most of the more commonly used rod end connections. If a rod end is required other than any of those shown, it would be machined from the Style "O" Rod end and identified as a Style "O" modified.

Rod end modifications to your specifications can be readily made and could include a radius, a spherical radius, special thread size or length or both, keyway, special drilled holes and many other variations too numerous to mention.

Rod Dia. mm.	A	AC	AD	AE	AF	C	D	IM	KK	CC	LG
5/8	3/4	1 1/8	5/8	1/4	3/8	3/8	1/2	1/2-20	7/16-20	5/8-18	1/2
1	1 1/8	1 1/2	15/16	3/8	11/16	1/2	7/8	7/8-14	3/4-16	1-14	13/16
1 3/8	1 5/8	1 3/4	1 1/16	3/8	7/8	5/8	1 1/8	1 1/4-12	1-14	1 3/8-12	1 1/4
1 3/4	2	2	1 5/16	1/2	1 1/8	3/4	1 1/2	1 1/2-12	1 1/4-12	1 3/4-12	1 5/8
2	2 1/4	2 5/8	1 11/16	5/8	1 3/8	7/8	1 11/16	1 3/4-12	1 1/2-12	2-12	1 7/8
2 1/2	3	3 1/4	1 15/16	3/4	1 3/4	1	2 1/16	2 1/4-12	1 7/8-12	2 1/2-12	2 5/8
3	3 1/2	3 3/4	2 7/16	7/8	2 1/4	1	2 5/8	2 3/4-12	2 1/4-12	3-12	3 1/8
3 1/2	3 1/2	4 3/8	2 11/16	1	2 1/2	1	3	3 1/4-12	2 1/2-12	3 1/2-12	3 1/8
4	4	4 1/2	2 11/16	1	3	1	3 3/8	3 3/4-12	3-12	4-12	3 5/8
4 1/2	4 1/2	5 1/4	3 3/16	1 1/2	3 1/2	1	3 7/8	4 1/4-12	3 3/4-12	4 1/2-12	4 1/8
5	5	5 3/8	3 3/16	1 1/2	3 7/8	1	4 1/4	4 3/4-12	3 1/2-12	5-12	4 5/8
5 1/2	5 1/2	6 1/4	3 15/16	1 7/8	4 3/8	1	4 5/8	5 1/4-12	4-12	5 1/2-12	5 1/8

*For Style #1 Rod End "D" Dimension: 5/8" Rod D = 7/16"
1" Rod D = 13/16"

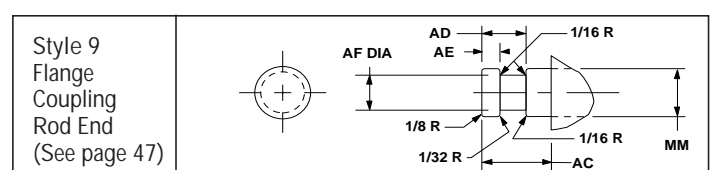
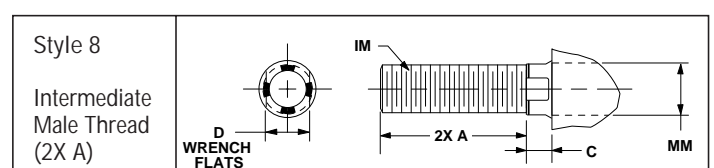
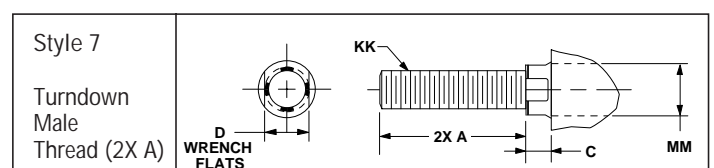
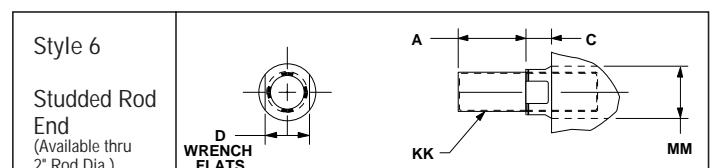
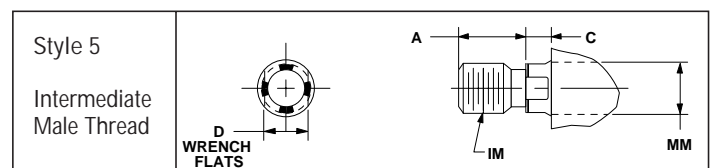
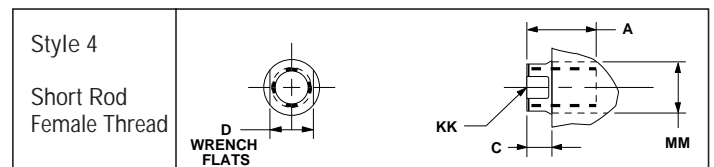
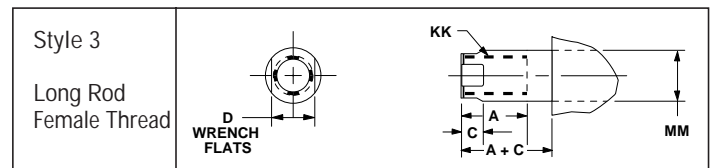
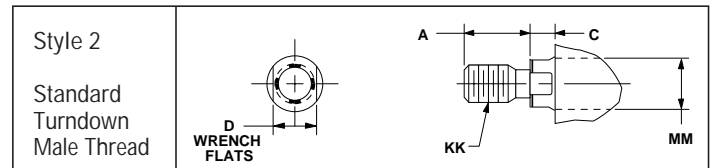
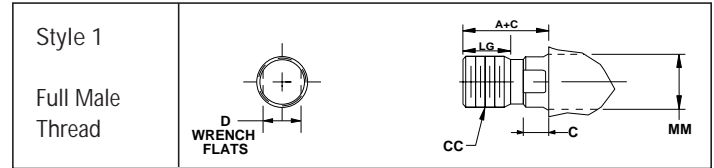
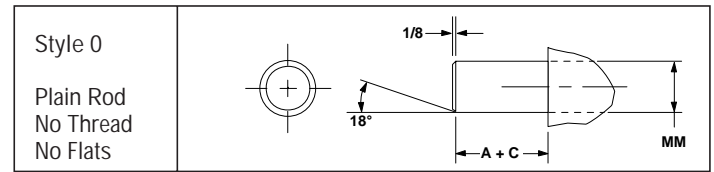

Miller HV Series Hydraulic Cylinders

Selecting Rod End Accessories

Pivot Pin

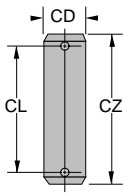

Eye Bracket

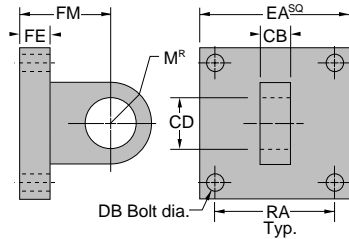

Clevis Bracket

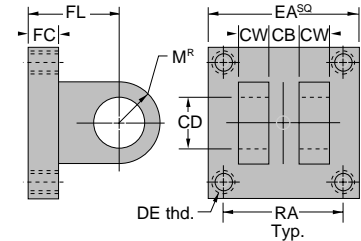

Pivot Pin Part No. Shear Load Capacity (lbs)	Eye Bracket Part No. Tensile Load Capacity (lbs)	Clevis Bracket Part No. Tensile Load Capacity (lbs)	Pin Dia	M	CB	CD	CL	CW	CZ	DB	DE	EA	FC	FE	FL	FM	RA
057-PP001-50 4,900	057-EB001-50 3,600	170-MB86A-150-50 5,000	1/2	1/2	3/4	1/2	1.83	1/2	2.28	3/8	3/8-24	2 1/2	3/8	3/8	1 1/8	1 1/8	1.63
057-PP001-75 11,000	—	170-MB86A-200-75 11,000	3/4	3/4	1 1/4	3/4	2.58	5/8	3.09	—	1/2-20	3	5/8	—	1 7/8	—	2.05
—	† 057-EB001-75 11,000	—	3/4	3/4	1 1/4	3/4	2.58	—	3.09	1/2	—	3 1/2	—	5/8	—	1 7/8	2.55
057-PP001-75 11,000	—	170-MB86A-250-75 11,000	3/4	3/4	1 1/4	3/4	2.58	5/8	3.09	1/2	1/2-20	3 1/2	5/8	5/8	1 7/8	1 7/8	2.55
057-PP001-100 19,600	057-EB001-100 17,000	170-MB86A-325-100 17,000	1	1	1 1/2	1	3.08	3/4	3.59	5/8	5/8-18	4 1/2	3/4	3/4	2 1/4	2 1/4	3.25
057-PP001-138 37,000	057-EB001-138 21,000	170-MB86A-400-138 30,000	1 3/8	1 3/8	2	1 3/8	4.08	1	4.66	5/8	5/8-18	5	7/8	7/8	3	3	3.82
057-PP001-175 60,000	057-EB002-175 51,000	170-MB86A-500-175 53,000	1 3/4	1 3/4	2 1/2	1 3/4	5.08	1 1/4	5.66	7/8	7/8-14	6 1/2	7/8	1	3 3/8	3 1/4	4.95
057-PP002-200 78,500	057-EB002-200 76,500	170-MB86A-600-200 75,000	2	2	2 1/2	2	5.08	1 1/4	5.72	1	1-14	7 1/2	1	1 1/2	3 1/2	4	5.73
057-PP002-250 122,700	057-EB002-250 94,500	170-MB86A-700-250 76,000	2 1/2	2 1/2	3	2 1/2	6.09	1 1/2	6.78	1 1/8	1 1/8-12	8 1/2	1	1 1/2	4	4 1/2	6.58
057-PP002-300 176,700	057-EB002-300 124,000	170-MB86A-800-300 114,000	3	2 3/4	3	3	6.09	1 1/2	6.84	1 1/4	1 1/4-12	9 1/2	1	2	4 1/4	5 1/4	7.50

† Dimensions apply to eye bracket only.

Note: Do not order clevis bracket to convert cylinders to 86 mounting. Contact factory.

Rod Eye

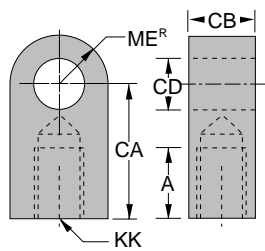

Rod Clevis

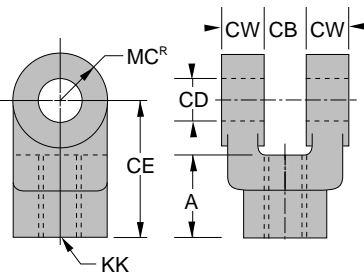

Rod Eye Part No. + Load Capacity (lbs)	Rod Clevis Part No. + Load Capacity (lbs)	Thd Size KK	A	MC	ME	CA	CB	CE	CD	CW
057-RE001-44-20 5,000	057-RC001-44-20 4,250	7/16-20	3/4	1/2	1/2	1 1/2	3/4	1 1/2	1/2	1/2
057-RE001-75-16 12,100	057-RC001-75-16 11,200	3/4-16	1 1/8	3/4	3/4	2 1/16	1 1/4	2 3/8	3/4	5/8
057-RE001-100-14 21,700	057-RC001-100-14 19,500	1-14	1 5/8	1	1	2 13/16	1 1/2	3 3/8	1	3/4
057-RE001-125-12 33,500	057-RC001-125-12 33,500	1 1/4-12	2	1 3/8	1 3/8	3 7/16	2	4 1/8	1 3/8	1
057-RE001-150-12 45,000	057-RC001-150-12 45,600	1 1/2-12	2 1/4	1 3/4	1 3/4	4	2 1/2	4 1/2	1 3/4	1 1/4
057-RE001-188-12 75,000	057-RC001-188-12 65,600	1 7/8-12	3	2	2	5	2 1/2	5 1/2	2	1 1/4
057-RE001-225-12 98,700	057-RC001-225-12 98,200	2 1/4-12	3 1/2	2 1/2	2 1/2	5 13/16	3	6 1/2	2 1/2	1 1/2
057-RE001-250-12 110,000	057-RC001-250-12 98,200	2 1/2-12	3 1/2	2 3/4	3	6 1/8	3	6 3/4	3	1 1/2
057-RE001-325-12 161,300	057-RC001-325-12 156,700	3 1/4-12	4 1/2	3 1/2	3 1/2	7 5/8	4	8 1/2	3 1/2	2
057-RE001-400-12 273,800	057-RC001-400-12 221,200	4-12	5 1/2	4	4	9 1/8	4 1/2	10	4	2 1/4

Miller HV Series Hydraulic Cylinders

Cylinder Rod End Accessories

Cylinder Rod End Accessories are used to affix the piston rod to the load—most commonly when the cylinder pivots during operation.

Piston Rod Attachments

In attaching machinery components or rod clevises, rod eyes, etc. to Miller Styles 2, 6 & 7 (Threaded on Turndown Section) or Styles 3 & 4 (Internally Threaded Piston Rods), the attachments should be tightened to the torques given in the Table at right. This torque or pre-stress triples the fatigue strength of the rod's threaded section and makes a stronger assembly than attaching the machinery component to a maximum diameter threaded rod (Style 5) and torquing it against a lock nut. Miller recommends the Style 2 (Threaded on Turndown Section) Rod for most applications. It's square shoulder design helps proper alignment of cylinder to mechanism, eliminates need for a jam nut, provides fixed point for more accurate cylinder positioning, and simplifies piloting of full rod diameter into mating part.

Rod Dia	Thread Size	Torque ft lbs*
5/8	7/16-20	36
1	3/4-16	125
1 3/8	1-14	250
1 3/4	1 1/4-12	460
2	1 1/2-12	663
2 1/2	1 7/8-12	944
3	2 1/4-12	1315
3 1/2	2 1/2-12	5050
4	3-12	7070
4 1/2	3 1/4-12	7940
5	3 1/2-12	12760
5 1/2	4-12	12560

*Recommended Torques (ft. lbs.) with MoS2 Lubricant or Equivalent.

Flange Coupling (For Use with Style #9 Rod End)

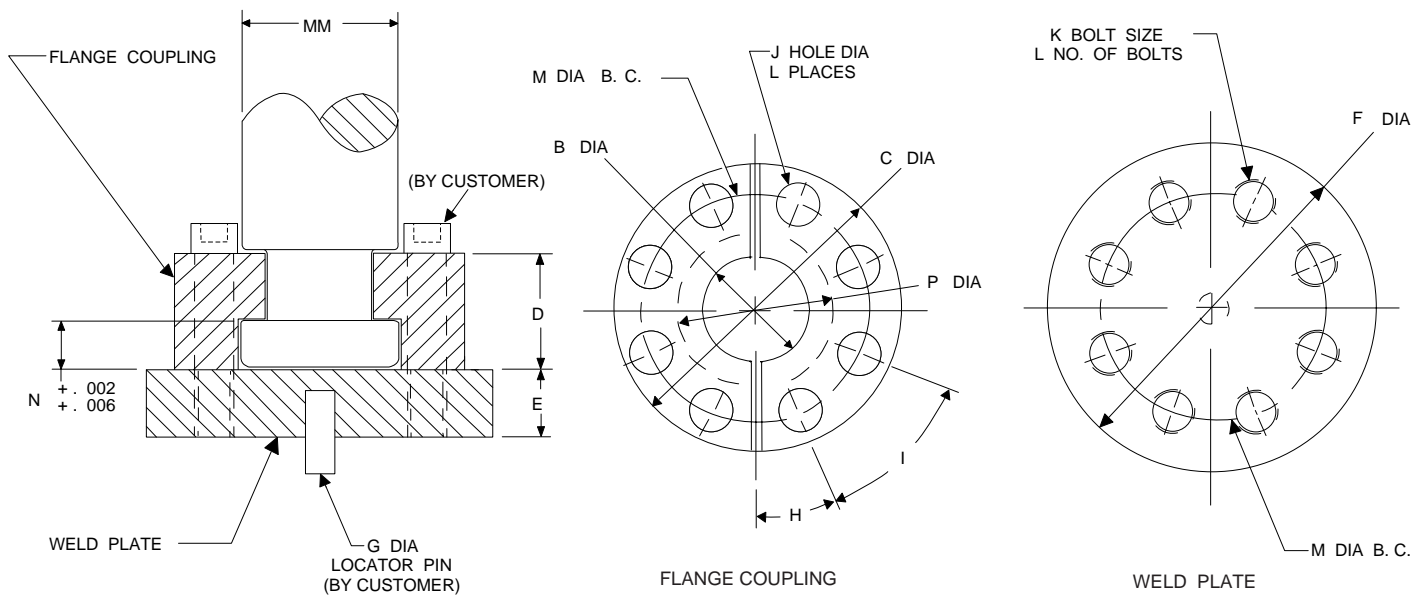

Flange Coupler Part No.	Weld Plate Part No.	MM	B	C	D	E	F	G	H	I	J	K	L	M	N	P
057-FC002-063	057-BA003-063	.625	.406	1.500	.562	.500	2.000	.250	45°	90°	.218	10-24	4	1.125	.250	.656
057-FC002-100	057-BA003-100	1.000	.750	2.000	.875	.500	2.500	.250	30°	60°	.281	1/4-20	6	1.500	.375	1.063
057-FC002-138	057-BA003-138	1.375	.938	2.500	1.000	.625	3.000	.250	30°	60°	.343	5/16-18	6	2.000	.375	1.438
057-FC002-175	057-BA003-175	1.750	1.187	3.000	1.250	.625	4.000	.250	22.5°	45°	.343	5/16-18	8	2.375	.500	1.813
057-FC002-200	057-BA003-200	2.000	1.438	3.500	1.625	.750	4.000	.375	15°	30°	.406	3/8-16	12	2.688	.625	2.063
057-FC002-250	057-BA003-250	2.500	1.875	4.250	1.875	.750	5.000	.375	15°	30°	.531	1/2-13	12	3.438	.750	2.625
057-FC002-300	057-BA003-300	3.000	2.375	5.000	2.375	1.000	5.500	.375	15°	30°	.531	1/2-13	12	4.000	.875	3.125
057-FC002-350	057-BA003-350	3.500	2.625	5.875	2.625	1.000	7.000	.375	15°	30°	.656	5/8-11	12	4.688	1.000	3.625
057-FC002-400	057-BA003-400	4.000	3.125	6.375	2.625	1.000	7.000	.375	15°	30°	.656	5/8-11	12	5.188	1.000	4.125
057-FC002-450	057-BA003-450	4.500	3.625	6.875	3.125	1.000	8.000	.375	15°	30°	.656	5/8-11	12	5.688	1.500	4.625
057-FC002-500	057-BA003-500	5.000	4.000	7.375	3.125	1.000	8.000	.375	15°	30°	.656	5/8-11	12	6.188	1.500	5.125
057-FC002-550	057-BA003-550	5.500	4.500	8.250	3.875	1.250	9.000	.375	15°	30°	.781	3/4-10	12	6.875	1.875	5.625

Miller HV Series Hydraulic Cylinders

Rod End Couplers

Dimensions



Good machine design practice requires that proper alignment be maintained to avoid excessive bearing loads. The Miller linear alignment rod end coupler can reduce minor cylinder misalignment problems, within design limitations. These couplers can be used for both push and pull applications.

Note: Use jam nut to lock coupler to rod when used with full diameter threads.

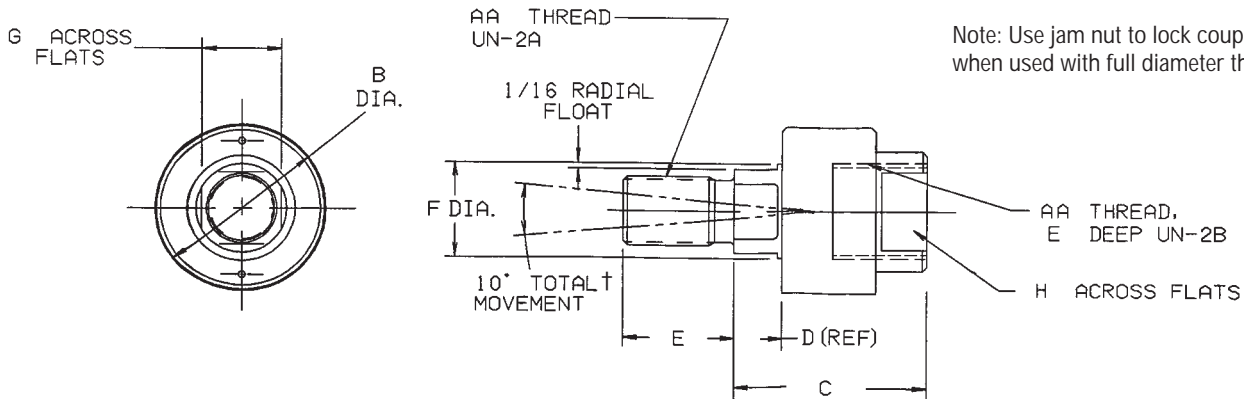

Part Numbers and Sizes

Part Number	AA	B	C	D	E	F	G	H	Max. Pull (LBS)
057-RCU01-44-20	7/16-20	1 1/4	2	1/2	3/4	5/8	9/16	1 1/8	2500
057-RCU01-50-20	1/2-20	1 1/4	2	1/2	3/4	5/8	9/16	1 1/8	3500
057-RCU01-63-18	5/8-18	1 1/4	2	1/2	3/4	5/8	1/2	1 1/8	3500
057-RCU01-75-16	3/4-16	1 3/4	2 5/16	5/16	1 1/8	31/32	7/8	1 1/2	8500
057-RCU01-88-14	7/8-14	1 3/4	2 5/16	5/16	1 1/8	31/32	7/8	1 1/2	8500
057-RCU01-100-14	1-14	2 1/2	2 15/16	1/2	1 5/8	1 3/8	1 1/4	2 1/4	16000
057-RCU01-125-12	1 1/4-12	2 1/2	2 15/16	1/2	1 5/8**	1 3/8	1 1/4	2 1/4	16000
057-RCU01-150-12	1 1/2-12	3 1/4	4 3/8	13/16	2 1/4	1 3/4	1 1/2	3	33500
057-RCU01-175-12	1 3/4-12	3 1/4	4 3/8	13/16	2 1/4	1 3/4	1 1/2	3	33500
057-RCU01-188-12	1 7/8-12	3 3/4	5 7/16	1 1/16	3	2 1/4	1 7/8	3 1/2	60000
057-RCU01-200-12	2-12	3 3/4	5 7/16	1 1/16	3	2 1/4	1 7/8	3 1/2	60000
057-RCU02-225-12	2 1/4-12	6 3/4	6 3/8	1	3 1/2	2 3/4	2 3/8	2 7/8	99250
057-RCU02-250-12	2 1/2-12	7	6 1/2	1	3 1/2	3 1/4	2 7/8	3 3/8	123750
057-RCU02-275-12	2 3/4-12	7	6 1/2	1	3 1/2	3 1/4	2 7/8	3 3/8	150950
057-RCU02-300-12	3-12	7	6 1/2	1	3 1/2**	3 1/4	2 7/8	3 3/8	180850
057-RCU02-325-12	3 1/4-12	9 1/4	8 1/2	1	4 1/2	4	3 3/8	4 1/2	213450
057-RCU02-425-12	4 1/4-12	12 7/8	11 1/4	1	4 1/2	5 1/2	4 7/8	7	370850

** 'E' thread is not deep enough to accept rod end style #2 standard 'A' thread length. Piston Rod style #2 thread for these sizes must be this 'E' dimension or shorter to permit torquing of Rod End Coupler to piston rod shoulder.

* Load in pounds. 4.1 safety factor.

† 10° Total Movement on 2 1/4" -12 thread and larger.

2° Total Movement on 7/16"-20 through 2"-12 thread.

On Long Stroke Horizontally Mounted Cylinder, see pages 56 and 57 for Stop Tube Requirements.

Adjustable on Retract Stroke

Available at additional cost. Stroke adjusting screw is furnished in cap end of cylinder. Turning it in or out limits the retract stroke to the precise length desired. Note: Stroke adjustments should be made at Zero fluid pressure only. Teflon Tru-Seal fitting provides positive seal against leakage, as well as providing adjustment lock. Cap end cushion not available with this option.

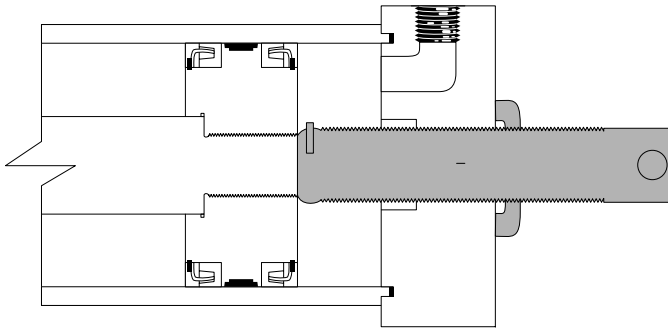

Adjustable on Extend Stroke

Available at additional cost. Using a double rod end cylinder, the extend stroke can be adjusted by repositioning the lock nuts on the threaded rod extension on the adjustment end.

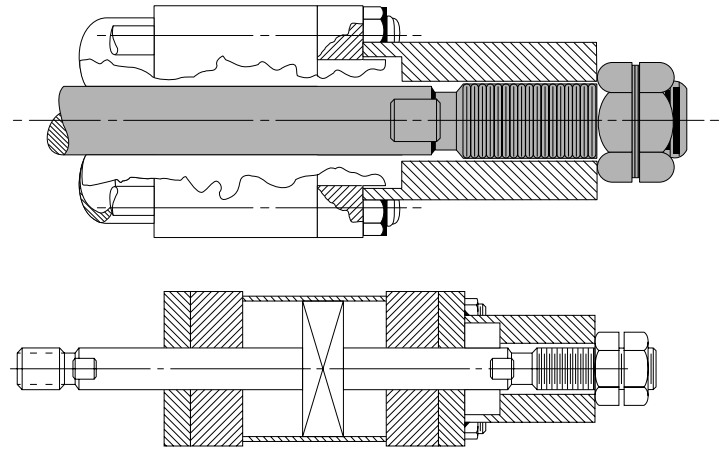

Other Available Cylinder Modifications

Rod End Modifications

Miller can produce a wide variety of custom rod end styles such as special threads and non-standard size turndowns. For unusual modifications, involving more than just a change in dimensions, submit a sketch or drawing to Miller for a determination as to cost and feasibility.

Special Ports

Standard HV cylinder ports are SAE. However, equivalent NPT or oversize SAE or NPT ports are available as options.

Air Bleeds

Miller cylinders can be ordered with optional self or manual air bleeds.

Heavy Chromed Tubes and Piston Rods

Miller can provide an optional 0.002 to 0.003 inch heavy chrome plating on cylinder tube I.D. and piston rods.

Stainless Steel Piston Rods

Miller can supply cylinders with 17-4 or other types of stainless steel piston rods. Contact Miller Fluid Power application engineering department regarding any special piston rod material.

More Options

Viton Seal Materials

Designs to meet specialized requirements: Nuclear, ASME, ABS, AWWA, SUB SEA, and Various Automotive Industry and Military Specifications.

Special Coatings and Painting

Grease Fitted Rod Bushing

External Drainback

End of Stroke Magnetic Principle Type Proximity Switch

Specify on Order:
Magnetic Principle Proximity Switch

Reliable: Proximity type sensor never contacts cylinder moving parts; eliminating wear and adjustments.

Positive Action: Multiple magnet design provides "snap action". Eliminates creep and false signals.

Versatile: Sealed stainless steel switch body can be used with any operating fluid and is impervious to most environmental conditions.



OPERATING PRINCIPLE

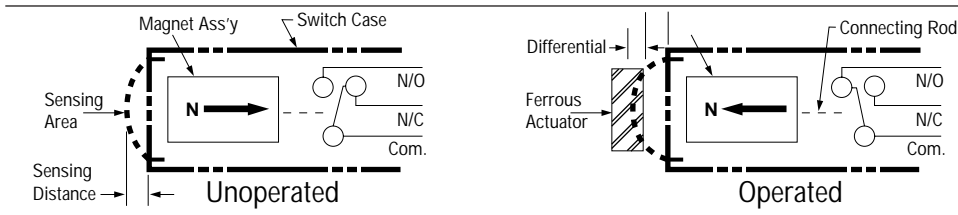

Switch Options
Pressure ratings to 5000 PSI.
Quick disconnect.
Explosion proof.
Sub sea, to 2000 feet depths.
Extra-long leads.

As shown in the sketches above, these switches are magnetically operated. Dual magnets provide a dependable "snap action" for positive position sensing.

In the "unoperated" position, the magnet assembly is attracted in the direction of the arrow, causing a finely ground stainless steel connecting rod to hold the contacts open.

In the "operated" position a ferrous part (cushion or piston) enters the sensing area and attracts the magnet assembly which causes the rod to draw the contacts closed.

Specifications

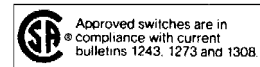

Switch Type:
Magnetic Principle
Contacts:
Single Pole-Double Throw (SPDT)
Contact Rating*:
2 Amp at 110-240 VAC (UL & CSA) 100 MA at 12 VDC 50 MA at 24 VDC (CSA)
Note: Check current draw of solenoid valves.
Connection: 18" long, 3 wire, potted in cable.
Can be wired Normally Open or Normally Closed. Leads are tagged (Com, N/O, N/C)
Pressure Rating: 3000 PSI Non Shock

Temperature Range:
- 20°F. to + 200°F (UL 104°F. Max.)
Sensing Gap:
.030 to .060 inch
Trip Point: Factory Set with Piston Bottomed out
Release Point: Approximately 1/4" Piston Travel Min. Cyl. stroke 1/2" on 1 1/2" & 2" bore, 3/4" stroke on 2 1/2" and up.
*UL and CSA approved for industrial control, general purpose use. If Class I, Division 1 or 2 is required, please specify.

Miller HV Series Hydraulic Cylinders

Switch Extension for Standard Side Position or Optional End Cap Position

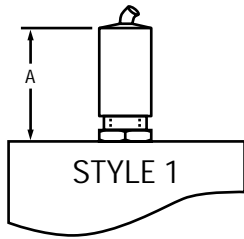

Standard location for switch mounting is any available side position. Please specify side location (1, 2, 3 or 4) desired. Cylinders are standardized as cushioned. Models 67/68 in positions #2 & #4 require special machining.

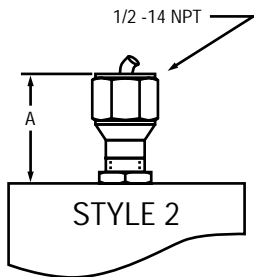

		SWITCH EXTENSION IN INCHES							
		EXCEPT MODEL 67/68 POS 2 OR 4				MODEL 67/68 POS 2 OR 4			
		HEAD		CAP		HEAD		CAP	
BORE	ROD	A	STYLE	A	STYLE	A	STYLE	A	STYLE
1½	.625	2.64	1	2.39	1	2.69	2	2.44	2
	1.000	2.76	1	2.39	1	2.82	2	2.44	2
2	1.000	2.57	1	2.26	1	2.44	2	2.13	2
	1.375	2.70	1	2.26	1	2.57	2	2.13	2
2½	1.000	3.25	2	2.94	2	2.19	2	1.88	2
	1.375	3.44	2	2.94	2	2.38	2	1.88	2
	1.750	3.57	2	2.94	2	2.50	2	1.88	2
3¼	1.375	2.94	2	2.57	2	3.13	2	2.75	2
	1.750	3.18	2	2.57	2	3.36	2	2.75	2
	2.000	3.32	2	2.57	2	2.00	2	2.75	2
4	1.750	2.93	2	2.32	2	3.11	2	2.50	2
	2.000	3.07	2	2.32	2	3.25	2	2.50	2
	2.500	3.38	2	2.32	2	2.07	2	2.50	2
5	2.000	2.32	2	1.75	2	2.19	2	1.63	2
	2.500	2.63	2	1.75	2	2.50	2	1.63	2
	3.000	2.94	2	1.75	2	2.82	2	1.63	2
	3.500	3.07	2	1.75	2	2.94	2	1.63	2
6	2.500	2.13	2	2.75	2				
	3.000	2.44	2	2.75	2				
	3.500	2.57	2	2.75	2	N/A		N/A	
	4.000	2.75	2	2.75	2				
7	3.000	1.94	2	2.44	2				
	3.500	2.13	2	2.44	2				
	4.000	2.38	2	2.44	2	N/A		N/A	
	4.500	2.63	2	2.44	2				
8	5.000	2.88	2	2.44	2				
	3.500	1.63	2	2.13	2				
	4.000	1.88	2	2.13	2				
	4.500	2.13	2	2.13	2	N/A		N/A	
	5.000	2.38	2	2.13	2				
	5.500	2.63	2	2.13	2				

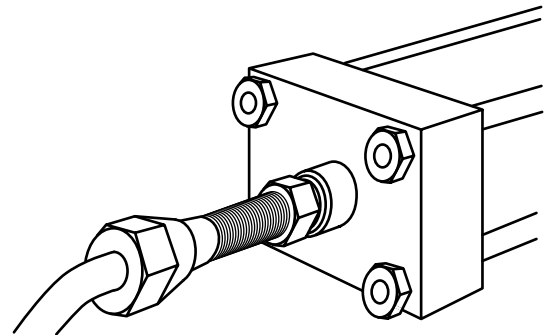

Optional mounting in rear face of cap does not require cushion.

TABLE SHOWING EXTENSION OF SWITCH FROM ENDCAP *

* NOTE: THE DEPTH TO WHICH A SWITCH IS INSTALLED MAY VARY AND STILL BE IN SENSING RANGE. THEREFORE, THE CALCULATED EXTENSION OF THE SWITCH IS APPROXIMATE.

End of Stroke Inductive Type Proximity Switch

Specify on Order:

Inductive Type Proximity Switch

Proximity Sensor is weld field immune. Switch body may be rotated in 90° increments to position the quick disconnect. Housings meet NEMA 1, 4, & 13 requirements.

This solid state switch emits a small directional radio frequency field. When the cushion plunger enters the field, eddy current losses occur. When these losses exceed a set level, the switch output is energized.

The 2 wire circuit will operate on AC or DC. It operates reliably as a programmable controller input or with relay load. Off state current is factory set at 1.7 mA. The 1.7 mA type will generally allow direct connection to most P.C.'s without adding shunt resistors.

SHORT CIRCUIT PROTECTION is a standard feature on AC models. Unique Short Circuit Protection (SCP) protects the switch from shorts in the load or line. Upon sensing a short condition (5 Amp or greater current) the switch assumes a non-conducting mode. The fault condition must be removed and power turned off to reset, preventing automatic restarts. An SCP indicator LED illuminates to indicate a short condition. A second LED illuminates with power on and the switch non-conducting (no target present on N.O. outputs).

Specifications

EE230

Pressure
3000 PSI
Sensing Range
.040 ± 10%
Operating Temp. Range
-20° to 70°C (-4 to 158°F)
Repeatability
.001"
Switching Differential
10%
2-Wire AC
Supply Voltage (50/60 Hz)
20 - 220 VAC/DC

"On-State" Voltage Drop
10V @ 5 - 500 mA
Load Current
Max. 0.5 Amp
Min. 5 mA
Inrush Current (rms 1 cycle)
3 Amp
"Off-State" Current
1.7 mA
Short circuit protection:
standard (SCP)
Indicating LED's: standard
1) Power on/non-conducting
2) SCP mode

End of Stroke Inductive Type Proximity Switch

Specify on Order:
Inductive Type Proximity Switch

Proximity Sensor is weld field immune. Switch body may be rotated in 90° increments to position the quick disconnect. Housings meet NEMA 1, 4, & 13 requirements.

This solid state switch emits a small directional radio frequency field. When the cushion plunger enters the field, eddy current losses occur. When these losses exceed a set level, the switch output is energized.

The 2 wire circuit will operate on AC or DC. It operates reliably as a programmable controller input or with relay load. Off state current is factory set at 1.7 mA. The 1.7 mA type will generally allow direct connection to most P.C.'s without adding shunt resistors.

SHORT CIRCUIT PROTECTION is a standard feature on AC models. Unique Short Circuit Protection (SCP) protects the switch from shorts in the load or line. Upon sensing a short condition (5 Amp or greater current) the switch assumes a non-conducting mode. The fault condition must be removed and power turned off to reset, preventing automatic restarts. An SCP indicator LED illuminates to indicate a short condition. A second LED illuminates with power on and the switch non-conducting (no target present on N.O. outputs).

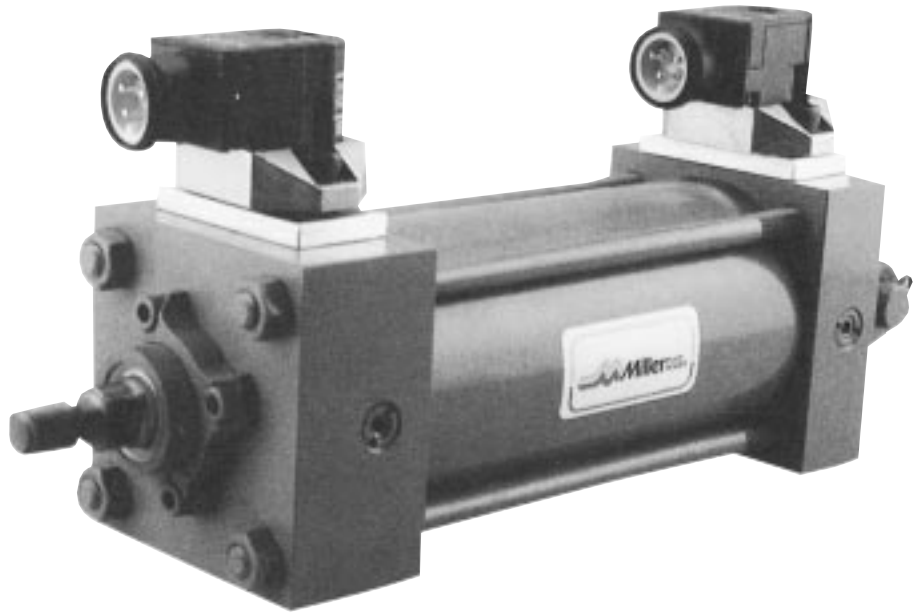

Specifications

EE230

Pressure
3000 PSI
Sensing Range
.040 ± 10%
Operating Temp. Range
-20° to 70°C (-4 to 158°F)
Repeatability
.001"
Switching Differential
10%
2-Wire AC
Supply Voltage (50/60 Hz)
20 - 220 VAC/DC

"On-State" Voltage Drop
10V @ 5 - 500 mA
Load Current
Max. 0.5 Amp
Min. 5 mA
Inrush Current (rms 1 cycle)
3 Amp
"Off-State" Current
1.7 mA
Short circuit protection:
standard (SCP)
Indicating LED's: standard
1) Power on/non-conducting
2) SCP mode

Miller HV Series Hydraulic Cylinders

Wiring Diagrams

COLOR CODE

- 1. GREEN
- 2. BLACK (RED)
- 3. WHITE (RED)

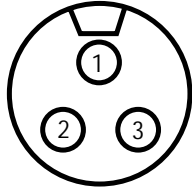

(3) PIN RECEPTACLE (AC)

3 wire DC only with NPN or PNP output is available. DC versions are 10-30 VDC Sink or Source and are reverse polarity and short circuit protected.

2-WIRE AC/DC

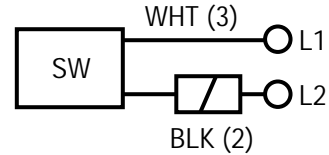

INTERNALLY SHORT CIRCUIT PROTECTED

PIN #1 NOT USED.

The 2-wire AC versions are designed to work within one inch of AC resistance welder tips carrying 20,000 Amperes.

Switch and Spacer Heights

Standard location for switch mounting is any available side location. Please specify side location (1, 2, 3, or 4) desired.

LOW PROFILE ROTATABLE SWITCH

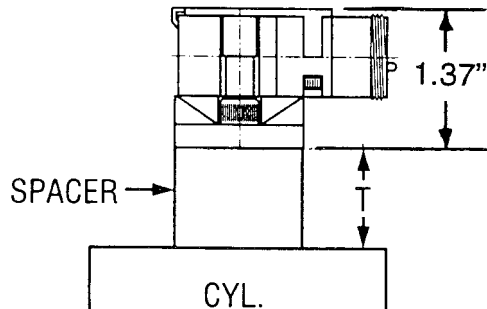

BORE	All Models Except 67/68 In Position 2 & 4		Model 67/68 In Position 2 & 4	
	ROD	T	ROD	T
1½	.625	1.274	.625	1.212
	1.000	1.425	1.000	1.360
	CAP	1.024	CAP	0.962
2	1.000	0.175	1.000	0.154
	1.375	0.314	1.375	0.300
	CAP	0.900	CAP	0.649
2½	1.000	0.154	1.000	0.712
	1.375	0.112	1.375	0.900
	CAP	0.649	CAP	0.400
¾	1.375	0.649	1.375	0.154
	1.750	0.884	1.750	0.381
	CAP	0.275	CAP	0.674
4	1.750	0.630	1.750	0.134
	2.000	0.774	2.000	0.275
	CAP	0.836	CAP	0.425
5	2.000	0.836	2.000	0.112
	2.500	0.336	2.500	0.425
	CAP	0.275	CAP	0.336
6	2.500	0.649	2.500	0.462
	3.000	0.154	3.000	0.774
	CAP	0.674	CAP	**
7	3.000	0.462	3.000	**
	3.500	0.649	3.500	0.275
	CAP	0.363	CAP	**
8	3.500	0.154	3.500	**
	4.000	0.400	4.000	**
	CAP	0.836	CAP	**

** Check with Miller Application Engineering.

Having chosen your bore size, you are now ready to verify whether the standard port size will provide the cylinder speed you require. Follow these simple steps to find out:

1. Divide your cylinder stroke length (in inches) by the length of time (in seconds) permitted for the stroke to take place. Multiply the result by 60 to obtain the stroke speed in inches per minute.

Example: 20-inch stroke, 2 seconds
 $20 \div 2 = 10$ inches/second
 $10 \times 60 = 600$ inches/minute

2. In the Bore Size Estimation Table on Page 57, right hand column of chart, find the oil consumption per inch of stroke for the cylinder bore you have chosen. Multiply the stroke speed calculated in Step 1 by the oil consumption per inch of stroke. This will give you the oil consumption per minute.

Example: $3\frac{1}{4}$ -inch bore, push stroke cylinder
 $600 \times 0.0359 = 21.54$ gallons/minute

3. Find the standard port size for the cylinder you have chosen by returning to the appropriate series section and locating dimension "EE" for your bore size in the table of common dimensions.

Example: $3\frac{1}{4}$ -inch bore Cylinder
 Dimensional Table shows -12 SAE Port or $\frac{3}{4}$ -14 NPT, which means the standard port size is $\frac{3}{4}$ inch (and has 14 NPT threads per inch of length).

4. In the Pipe and Port Size Table on Page 59 find the value for oil flow (in gallons per minute) which is in the "15 feet per second" column and the row corresponding to your standard port size.

Example: $\frac{3}{4}$ inch port
 Table row " $\frac{3}{4}$ S", column "15 ft. per sec."
 shows 25.17 gallons per minute

5. If the flow rate found in Step 4 is greater than or equal to that calculated in Step 2, then the standard size port is adequate, and you should proceed to the next step. If the Step 4 rate is less than the Step 2 rate, then return to the Pipe and Port Size Table and find the flow rate value in the "15 ft. per sec." column which is equal to (or larger than but closest to) the Step 2 flow rate. In the same row, move across the table to the first column and find the proper oversize port dimension.

Example: 25.17 is the number shown in the "15 ft. per second column" which is larger than but closest to 21.54. Looking across to the first column $\frac{3}{4}$ S, which means $\frac{3}{4}$ inch NPT or -12 SAE standard port would be adequate.

Calculating System Pressure Drop

To insure that your hydraulic pump will maintain the desired operating pressure, calculate the pressure drop of the system by following these steps:

1. Write down each of the following for your system:

- Length of straight pipe from pump to cylinder
- Number of elbow fittings
- Number of tee fittings
- Number of 2- and 3-way valves
- Number of 4-way valves

2. Refer to the right hand columns in the Pipe and Port Size Table on Page 59, and in the row which corresponds to your pipe (port) size, find and note the equivalent per foot pipe length for your fittings and valves ("b" through "e" above). Multiply the equivalent lengths by the number of each type of valve or fitting you have.

Example: $\frac{3}{4}$ -inch ports and pipe
 3 elbows $3 \times 2.2 = 6.6$
 1 tee $1 \times 4.6 = 4.6$
 1 2-way valve $1 \times 30^* = 30.0$
 * 30 is midway between 10 and 50

3. Add up the equivalents in Step 4 and the length of straight pipe in the system.

Example: 18 feet of straight pipe
 $6.6 + 4.6 + 30.0 + 18.0 = 59.2$ ft.

4. Return to the Pipe and Port Size Table on Page 59 and in the "15 ft. per sec. column" and row which corresponds to your pipe (port) size, find the per foot pressure drop. Multiply this value by the system length calculated in Step 3.

Example: $\frac{3}{4}$ -inch pipe
 1.17×59.2
 $= 69.3$ PSI of pressure drop

5. Subtract the pressure drop arrived at in Step 4 from the rated pressure for your hydraulic pump to determine the actual available pressure. If the available pressure is equal to or greater than the operating pressure you had been planning to use, then there is no problem and you may proceed to the next page. But if it is less, you should consider reducing the pressure drop by going to oversize ports and pipe, if you have not already done so.

Miller HV Series Hydraulic Cylinders

Pipe and Port Size Table

Butt Welded Steel Clean Pipe				Oil Flow (Gallons per Minute) and Friction Pressure Drop (Pounds per Square inch) Per Foot Length Pipe												Equivalent Length of Straight Pipe in Feet for Various Fittings				
				Velocity = 5 ft. per sec.		Velocity = 10 ft. per sec.		Velocity = 15 ft. per sec.		Velocity = 20 ft. per sec.		Velocity = 25 ft. per sec.		Velocity = 30 ft. per sec.						
* Pipe Size	Burst Press PSI	In-ternal Dia. Inches	In-ternal Area Sq. in.	Gals. per Min.	Pres-sure Drop in PSI	Gals. per Min.	Pres-sure Drop in PSI	Gals. per Min.	Pres-sure Drop in PSI	Gals. per Min.	Pres-sure Drop in PSI	Gals. per Min.	Pres-sure Drop in PSI	Gals. per Min.	Pres-sure Drop in PSI	Pipe Size	Elbow	Tee	Cyl. and 2&3 Way Valves	4 Way Valve
3/8 S	10,754	.493	.191	2.99	.58	5.98	1.19	8.97	2.35	11.96	3.71	14.95	5.44	17.94	7.31	3/8	1.3	3.0	5 to 25	10 to 50
1/2 S	10,784	.622	.304	4.74	.39	9.48	.82	14.31	1.65	18.96	2.75	23.70	4.00	28.44	5.36	1/2	1.5	3.3	6 to 30	12 to 60
3/4 X	11,728	.742	.433	6.76	.27	13.52	.69	20.28	1.38	27.04	2.15	33.80	3.12	40.56	4.15					
3/4 S	8,608	.824	.533	8.39	.22	16.78	.59	25.17	1.17	33.56	1.80	41.95	2.60	50.34	3.44	3/4	2.2	4.6	10 to 50	20 to 100
1 1/4 XX	18,408	.896	.630	9.83	.18	19.66	.54	29.49	1.07	39.32	1.64	49.15	2.37	58.98	3.13					
1 X	10,888	.957	.719	11.21	.16	22.42	.49	33.63	.97	44.84	1.54	56.05	2.22	67.26	2.93					
1 S	8,088	1.049	.864	13.59	.14	27.18	.43	40.77	.85	54.36	1.40	67.95	1.94	81.54	2.67	1	2.8	5.7	13 to 65	25 to 125
1 1/2 XX	16,840	1.100	.950	14.81	.13	29.62	.41	44.43	.81	59.24	1.34	74.05	1.86	88.86	2.44					
1 1/4 X	9,200	1.278	1.283	20.15	.11	40.30	.33	60.45	.65	80.60	1.07	100.75	1.53	120.90	2.00					
1 1/4 S	6,744	1.380	1.495	23.48	.10	46.96	.31	70.44	.60	93.92	.91	117.40	1.29	140.88	1.76	1 1/4	3.7	7.8	15 to 75	30 to 150
1 1/2 X	8,416	1.500	1.767	27.49	.09	54.98	.28	82.47	.53	109.96	.84	137.45	1.19	164.94	1.62					
2 XX	15,360	1.503	1.774	27.59	.09	55.18	.28	82.77	.53	110.36	.84	137.95	1.19	165.54	1.62					
1 1/2 S	6,104	1.610	2.036	31.68	.08	63.36	.25	95.04	.48	126.72	.71	158.40	1.05	190.08	1.43	1 1/2	4.4	9.2	20 to 100	40 to 200
2 1/2 XX	14,680	1.771	2.464	38.32	.07	76.64	.22	114.96	.40	153.28	.64	191.60	.94	229.92	1.30					
2 X	7,336	1.939	2.953	45.98	.06	91.96	.19	137.94	.36	183.82	.59	229.90	.87	275.88	1.11					
2 S	5,184	2.067	3.355	52.36	.05	104.72	.17	157.08	.32	209.44	.53	261.80	.77	314.16	1.05	2	5.5	12.0	25 to 125	50 to 250

S = Standard weight pipe X = Extra strong XX = Double extra strong

The pressure drop shown in the above table is for butt welded clean steel pipe. Pressure drop is the same regardless of operating pressure. Avoid large pressure drops in LOW PRESSURE SYSTEMS. Note that oil flows at high velocity (up to 30 ft. per sec.) with small pressure drop loss through large pipes but results in prohibitive loss in small pipes at this speed. Pipe line velocities in excess of 15ft./sec. might result in excessive shock loading. Hydraulic oil shown is approximately 225 S.S.U. at 100° F.— .88 specific gravity at 60° F, relative to water at 60° F. Approximate specific gravity at 100° F — .865. For water, the above figures are conservative (write to Miller for detailed calculations).

In order to accommodate large pump volumes without severe pressure drops, Miller hydraulic cylinders are available in most models with oversize ports with welded half pipe couplings or flange fittings.

*For tubing use I.D. in table closest to your tubing I.D.

Welded Oversize Ports

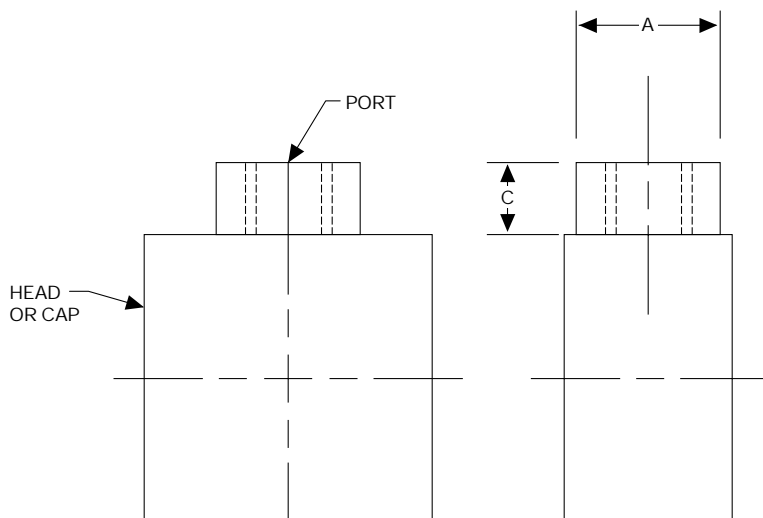

NPT PORT	A	C	SAE Port Dash #	Thread	A	C
3/4-14	1 3/8	1	(-6)	9/16-18	.875	.700
1-11 1/2	1 3/4	1 3/16	(-8)	3/4-16	1.125	.850
1 1/4-11 1/2	2 1/4	1 5/16	(-10)	7/8-14	1.375	.950
1 1/2-11 1/2	2 1/2	1 9/16	(-12)	1 1/16-12	1.375	.950
2-11 1/2	3	1 11/16	(-14)	1 3/16-12	1.625	1.100
			(-16)	1 5/16-12	1.625	1.100
			(-20)	1 5/8-12	2.125	1.100
			(-24)	1 7/8-12	2.500	1.100
			(-32)	2 1/2-12	3.000	1.200

The use of a stop tube is a generally accepted and preferred method for reducing piston and bearing loads on long push stroke cylinders and, additionally, for preventing jack-knifing or buckling of horizontally mounted, long stroke cylinders on push stroke. Stop tubes are more effective, less costly, and lighter in weight than oversize piston rods.

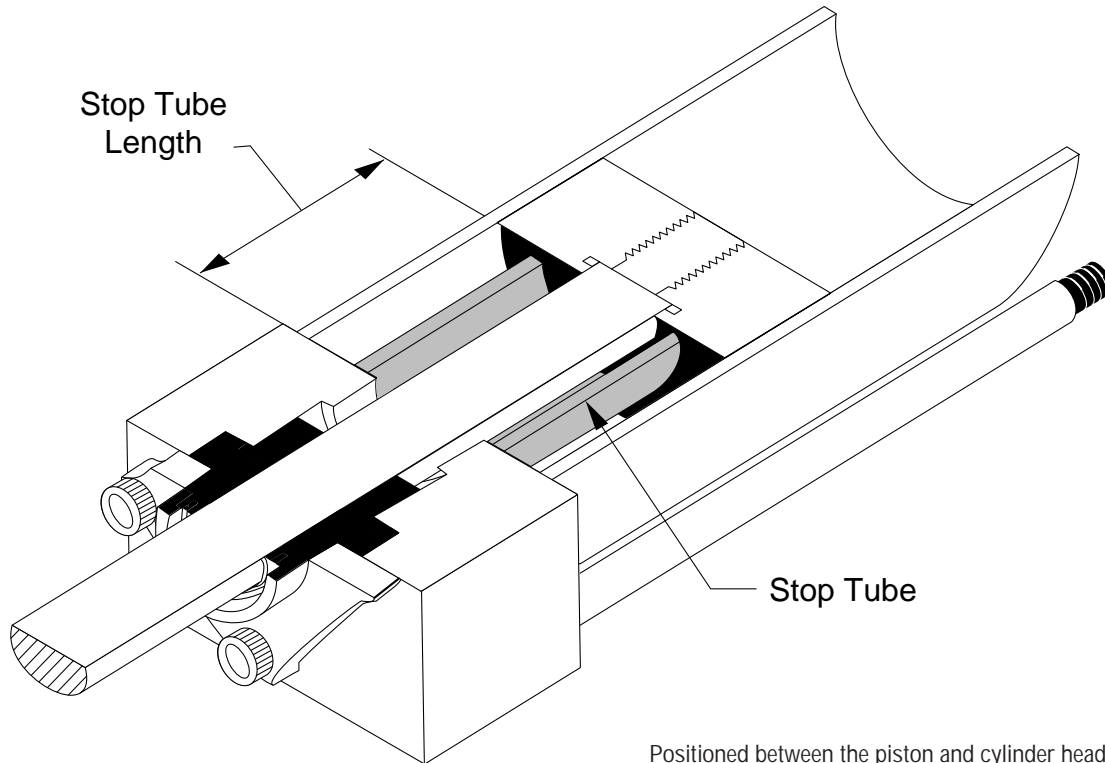

Positioned between the piston and cylinder head, a stop tube restricts the extended position of the rod so that the added distance between the piston and bushing results in less strain, wear, and bearing load.

Determining the Length and Need For Stop Tube

Follow these simple steps to determine whether your cylinder requires a stop tube, and, if so, how long it should be.

1. Examine the groups of cylinders illustrated on Page 61 and determine which, if any, of the mounting configurations corresponds to your cylinder application and model number.
2. If your cylinder mounting style corresponds to any of those in Group A, then no stop tube is required. But, if cylinder operates on push stroke, an oversize rod may be required and you should check the following page. If your cylinder is like one of those in Group B, then a stop tube is

recommended and you should proceed to Step 3. If your cylinder is similar to one of the Group C illustrations, then you should calculate the turning moments and loads between piston and rod bushing to insure that they are not excessive. Weight of fluid must be included on large dia. or long stroke cylinders. For assistance on this, contact Miller Fluid Power Application Engineering Dept. Next, continue on to Step 3 to determine the length of stop tube needed.

Miller HV Series Hydraulic Cylinders

3. Referring to the illustration which corresponds to your cylinder application, determine the value of "L". Be certain to include the thickness of the cylinder head, cap and piston assembly plus twice the length of the cylinder stroke. Then go down the first column of the Stop Tube Table and find the range which encompasses that value of "L". The number shown to the right in the second column is the length of stop tube your cylinder requires.

4. Add the stop tube length to your "L" dimension to obtain an "Adjusted L Dimension". This dimension will be used in the procedures on the following page to determine whether your cylinder requires an oversize piston rod in addition to the stop tube except models 53, 61, 63, 65, 67, 81, 83 & 89.

Stop Tube Table

"L" (inches)	Stop Tube Length (inches)	"L" (inches)	Stop Tube Length (inches)
0-40	0	171-180	14
41-50	1	181-190	15
51-60	2	191-200	16
61-70	3	201-210	17
71-80	4	211-220	18
81-90	5	221-230	19
91-100	6	231-240	20
101-110	7	241-250	21
111-120	8	251-260	22
121-130	9	261-270	23
131-140	10	271-280	24
141-150	11	281-290	25
151-160	12	291-300	26
161-170	13	301-310	27

Note: 'L' or 'D' are calculated from mounting point with rod extended.

Group A

With piston rod extended. To be checked for rod diameter only. Stop tube not required.

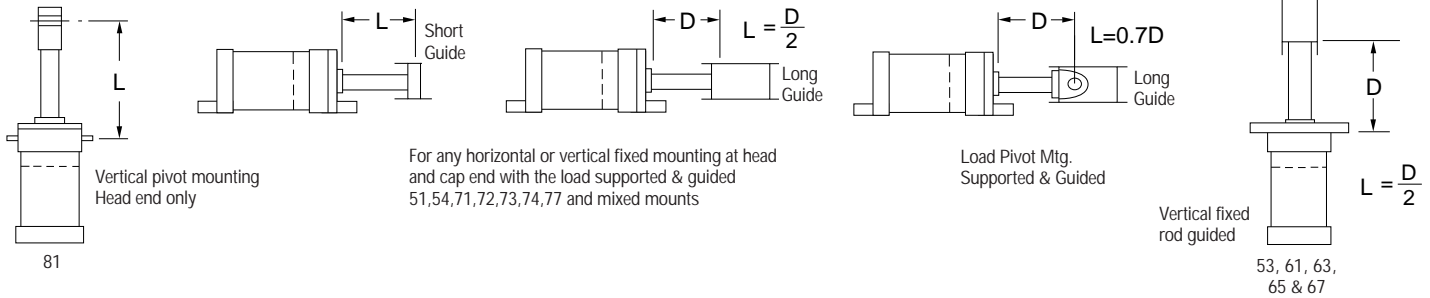

Group B

To avoid rod buckling or cylinder jackknifing, check for stop tube and rod diameter requirements with piston rod extended. Use cylinder dimensional charts. No stop tube required if cylinder operates on pull stroke only.

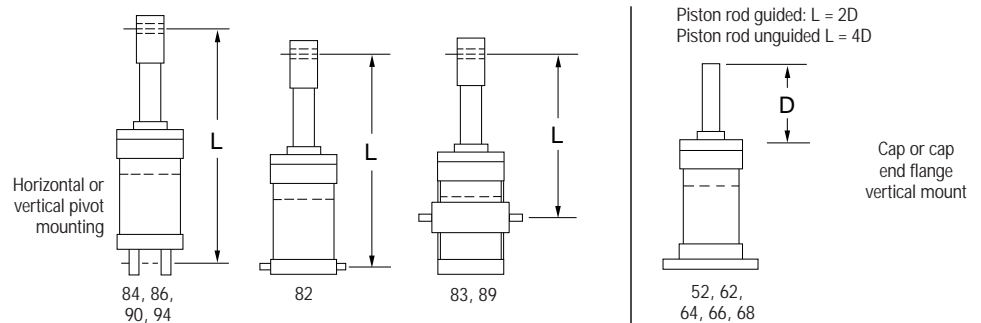

Group C

To be checked for Stop tube length and piston rod diameter to eliminate buckling or jackknifing with piston rod extended.

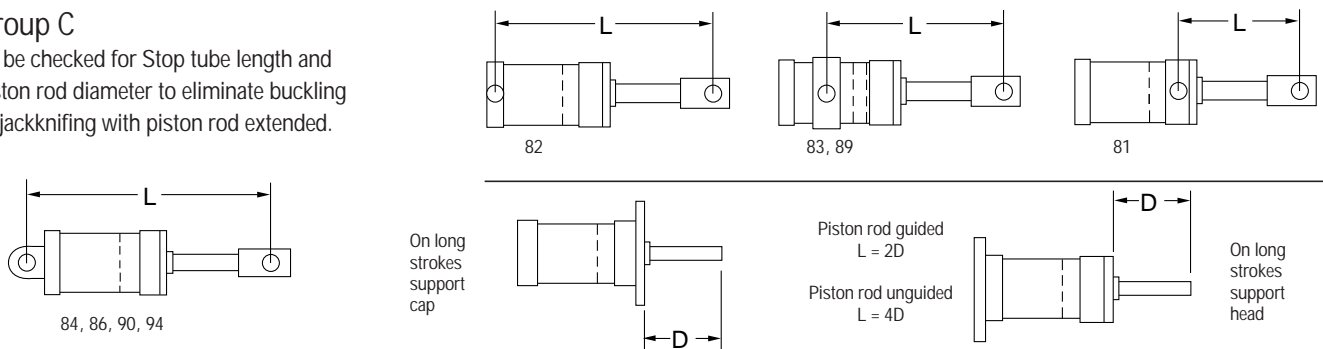

Long cylinder push strokes may need oversize piston rods due to column strength considerations.

Miller Fluid Power cautions against depending upon the higher rigidity of oversize rods to absorb or reduce side loading. Actually, the greater flexibility of a smaller standard diameter rod transmits less side loading back to the piston rod bushing. It is important to use the correct rod diameter based on the various factors involved in your application. Oversize rods, when not needed, merely add to the cylinder price and require longer delivery.

Standard rod diameters are recommended for all pull stroke cylinders. To determine the correct rod diameter for a push stroke application, follow these simple steps.

1. Referring to the Group A through C illustrations on the previous page, determine the value of "L" for your cylinder, or use the "Adjusted L Dimension" calculated in Step 4 on that page.
2. In the Oversize Piston Rod Table, find in the first column your cylinder thrust value which was previously determined.
3. Move across the table to the right end and in the same row locate your "L" or "Adjusted L Dimension". If the exact value is not shown, continue to the next larger number.
4. Go to the top of the column and you will find the correct rod diameter for your cylinder application.

Oversize Piston Rod Table

Thrust in lbs.	PISTON ROD DIAMETER												
	5/8"	1"	1 3/8"	1 3/4"	2"	2 1/2"	3"	3 1/2"	4"	4 1/2"	5"	5 1/2"	
250	43	94	146										
400	37	83	134	186									
700	30	68	118	168	202	275							
1,000	27	60	105	155	190	257	330						
1,400	24	53	92	142	174	244	308	385					
1,800	23	48	82	127	160	230	296	366	440				
2,400	19	45	75	114	145	213	281	347	415	488			
3,200	16	41	67	103	130	194	261	329	400	461			
4,000	13	38	63	94	119	175	240	310	378	446			
5,000	9	34	60	87	110	163	225	289	360	426	494		
6,000	5	30	56	82	102	152	208	274	342	410	476		
8,000	5	26	50	76	93	137	188	245	310	375	447		
10,000	4	21	45	70	89	125	172	222	279	349	412	482	
12,000	3	17	41	65	84	118	155	210	269	326	388	454	
16,000		9	34	57	75	110	142	188	235	292	350	420	
20,000		8	28	52	68	103	136	172	218	270	326	385	
30,000		6	12	39	55	87	120	156	189	230	285	330	
40,000			11	22	43	74	108	142	177	210	248	294	
50,000			9	15	30	66	96	130	165	200	234	269	
60,000				14	18	57	88	119	154	190	225	256	
80,000				12	16	36	71	104	137	170	204	240	
100,000					14	22	57	90	120	154	189	222	
120,000					12	21	45	77	108	140	175	207	
140,000						19	27	64	98	128	160	194	
160,000						17	26	47	86	118	148	182	
200,000						14	23	31	67	98	131	161	
250,000							19	28	36	72	109	141	
300,000								25	34	42	86	120	

Values of (L) for slenderness ratios (slenderness ratio = length ÷ radius of gyration = 4 x length ÷ piston rod diameter) greater than 50 have a safety factor of 5 to 1. Values of (L) for slenderness ratios less than 50 are based on compressive strength only (S = thrust ÷ rod area) and have safety factors between 2.4-1 and 5-1.

Miller HV Series Hydraulic Cylinders

Non-Sag Piston Rods for Long Stroke, Horizontally Mounted Cylinders

Miller patented non-sag piston rods reduce bushing wear on long stroke, horizontally mounted cylinders. Keyed in your machinery to prevent rotation, non-sag piston rods, in their prestressed position, remain straight

without the deflections or sag of ordinary rods. Using non-sag piston rods on long stroke cylinders prevents overloading of rod bushing and piston and the resulting costly damage.

Determining If Your Cylinder Requires A Non-Sag Rod

Miller cylinders have a commercial straightness of 0.002 inches per foot of length. The gravity-induced rod sag for horizontally mounted cylinders is given in the Rod Deflection Table. To determine if this sag is excessive, follow these simple directions.

1. After having checked the rod for column strength on the previous page, find your rod diameter in the first column of the table.
2. Read across the table to the column headed by the length of the rod between supports when rod is fully extended, and find the sag in inches which can be expected with a standard rod.
3. If this figure lies within the shaded area of the table, you should specify a non-sag rod.

Rod Deflection Table

This table shows the deflections in inches of ordinary piston rods at center of span. Length of piston rod between supports is in feet. Rod diameter and sag are in inches.

Dia. Piston Rod	Weight In Lbs. Per Ft.	LENGTH OF PISTON RODS (IN FEET) BETWEEN SUPPORTS WITH RODS EITHER EXTENDED OR RETRACTED																										
		5	6	7	8	9	10	11	12	13	14	15	16	17	18	19	20	21	22	23	24							
5/8	1.043	.065	.134	.255	.425	.675	1.020	1.500	5/8" rod not available in non-sag																			
1	2.670	.030	.053	.099	.166	.265	.385	.580	.850	1.160	1.570																	
1 1/8	5.049	.013	.028	.053	.088	.136	.212	.310	.450	.617	.830	1.100	1.418															
1 3/4	8.178	.008	.017	.033	.054	.086	.130	.192	.278	.380	.515	.680	.870	1.115	1.400													
2	10.680	.006	.013	.025	.042	.066	.101	.148	.212	.290	.390	.525	.670	.850	1.072	1.330												
2 1/2	16.690	.004	.0085	.016	.027	.042	.064	.094	.136	.186	.240	.335	.430	.545	.685	.856	1.040	1.286	1.520									
3	24.030		.006	.011	.018	.029	.045	.065	.094	.129	.175	.231	.296	.380	.475	.590	.722	.884	1.060	1.270	1.500							
3 1/2	32.710		.0043	.008	.014	.022	.033	.048	.069	.095	.128	.170	.218	.278	.350	.435	.530	.650	.780	.930	1.100							
4	42.730			.006	.010	.016	.025	.037	.053	.073	.098	.130	.166	.213	.267	.333	.405	.500	.595	.715	.844							
4 1/2	54.070			.005	.0082	.013	.020	.029	.043	.057	.078	.103	.132	.168	.212	.262	.320	.395	.470	.565	.670							
5	66.760				.0066	.0106	.016	.023	.034	.046	.063	.083	.107	.136	.171	.213	.260	.320	.380	.460	.545							
5 1/2	80.780				.0055	.0087	.013	.019	.028	.038	.052	.068	.088	.112	.142	.176	.215	.263	.315	.390	.450							

Standard Cylinder

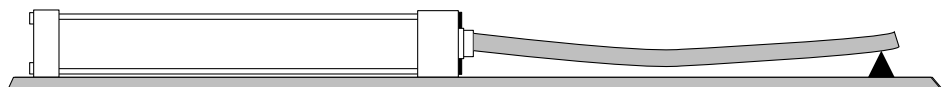

Non-Sag Rod Miller Cylinder

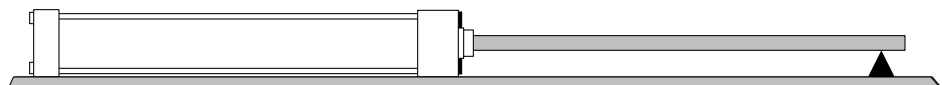

Miller HV Series Hydraulic Cylinders

Keying and Pinning Foot Mounting Cylinders

Foot mount cylinders should be keyed or pinned on the appropriate end to eliminate shearing loads on mounting bolts.

Cylinders with integral key mounts may be used where keyways can be cut in a machine member. This type of mounting accommodates shear loads, provides accurate alignment of the cylinder, and simplifies installation and servicing.

Only one end of a cylinder should be keyed to the machine. If both ends are keyed, there will be no cylinder elasticity to assist in absorbing shocks.

Locating pins may be used instead of shear keys to help take shear loads and to assure proper cylinder alignment. As with keys, cylinders

should be pinned at either end (but not both ends). Contrary to common die design practices, cylinders should never be pinned across corners. To do so can result in severe warping under operating pressures and temperatures.

Pivoted mounts should have the same type of pivots at both the cylinder body and rod end. If a simple pivot pin mount is used, the pivot pin axes at each end should be parallel. Trunnion mounts are generally designed to resist only shear loads. Therefore, self-aligning mounts should not be used to support the trunnions, otherwise bending forces can also be set up.

Keying a Cylinder

RIGHT

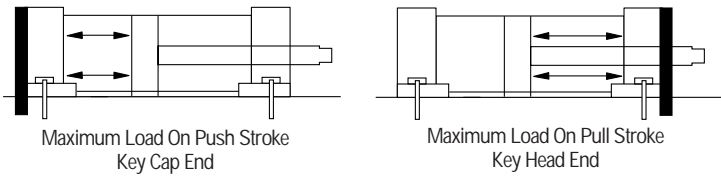

WRONG

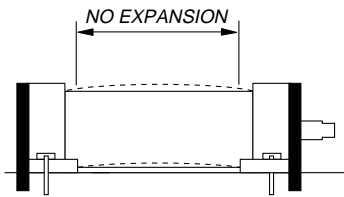

Pinning a Cylinder

RIGHT

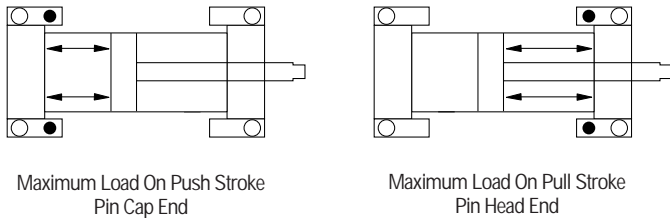

WRONG

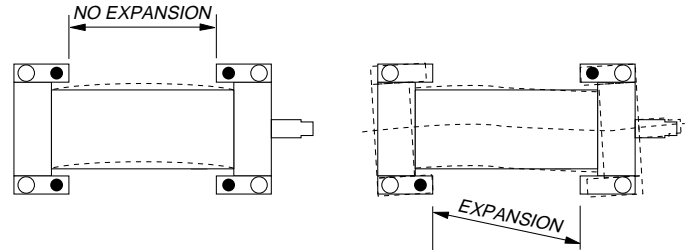

"K" Retainer-Key Extension

Provides Models 71,72,74, and 77 with Max. Mounting Rigidity Without Pins or Welded Keys

For a rugged mounting that cannot shift under maximum loads, the "K" retainer-key extension extends the rod retainer plate so that it slips into a slot milled in

machine's mounting surface. "K" retainer thickness is dimension $F^* = \begin{matrix} -0.0140 \\ -0.0145 \end{matrix}$. Extension = $\frac{E}{2}$. Available as option at additional cost.

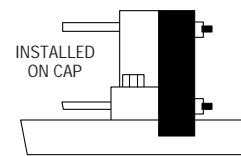
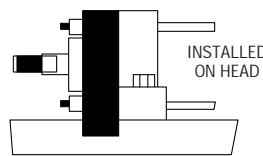
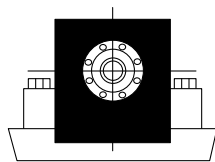

*See respective mounting pages for dimensions — Square Retainer Section

Miller HV Series Hydraulic Cylinders

Cylinder Installation Instructions

Installation:

For long, trouble free, safe operation of your cylinders, extra care should be taken in the following areas:

1. Fasteners:

Be sure to select fasteners suitable for the forces involved. The use of Grade 8 or better nuts & bolts is recommended. Due to the wide variety available, contact your bearing supplier for bearing recommendations.

2. Piston Rod Attachment & Rod Accessories:

In attaching machinery components or rod clevises, rod eyes, etc. to Miller Style 2 (Threaded or Turndown Section) or Style 4 (Internally Threaded Piston Rods), the attachments should be tightened to the torques given in chart 1. This torque or prestress triples the fatigue strength of the rod's threaded section and makes a stronger assembly than attaching the machinery component to a full diameter threaded rod (Style 1) and torquing it against a lock nut. Miller recommends the Style 2 (Threaded on Turndown Section) Rod for most applications. Its square shoulder design helps assure proper alignment of cylinder to mechanism, eliminates need for a jam nut, provides fixed point for more accurate cylinder positioning, simplifies piloting to full rod diameter into mating part.

3. Cylinder Mounting:

Fluid Power Cylinders are designed to be linear actuators. They are intended to provide motion and force along the centerline of the rod. Since they have limited capacity to withstand eccentric or radial loads, they should not be employed as linear bearings. The ideal method of mounting a cylinder to the machine is to have the point of mounting on the equipment machined to the exact dimensions with proper alignment, so that bolting the cylinder in place ensures perfect alignment. In many cases this is not practical from a cost and design standpoint. Therefore, alignment must be secured at the time of installation. Whenever the piston rod is fastened to the machine which confines the cylinder in one position, it is best to bolt the cylinder down as a last operation of assembly. Alignment can be secured in other ways, but the following sequence of installation steps is quite effective:

- A. Assemble the piston rod to the machinery. The piston rod must be fastened and held squarely so its centerline is parallel to the guides of the attached machinery (or parallel to the line of movement of the attached machinery in cases of fixed mounted cylinders.) Torque piston rod to attachment per chart 1.
- B. Insert mounting bolts but do not tighten them.
- C. In the case of horizontally mounted cylinders, it is necessary to support the weight of the cylinder body so as to eliminate strain on the piston rod.
- D. Use feeler gauges under the mounting and shim at these points equal to the space indicated by the feeler gauges.
- E. Finally, tighten the mounting bolts.
- F. If possible, the machine operation should be tested with low pressure air to insure that cylinder and attached parts are operating freely. This should be done with the machine operating under a no load condition.
- G. Insure that all pipes and fittings are clean before connecting them to the cylinder.
- H. Hydraulic filtration should be in accordance with the hydraulic power unit manufacturer's recommendation.

Cylinder Component Torque Values

Chart 1

Piston Rod Torque (ft./lbs.)		
Bores	Thread Size	Torque ft./lbs. *
1 1/2	7/16-20	36
2, 2 1/2	3/4-16	125
3 1/4	1-14	250
4	1 1/4-12	460
5	1 1/2-12	663
6	1 7/8-12	944
7	2 1/4-12	1315
8	2 1/2-12	5050

Chart 2

Tie Rod Torque (ft./lbs.)				
Bore	Except Models 61, 62, 65, 66		Models 61, 62, 65, 66	
	Dry	Moly*	Dry	Moly*
1 1/2	16		13	
2		32		27
2 1/2		50		42
3 1/4		90		75
4		145		97
5		270		180
6		375		188
7		590		295
8		900		450

Chart 3

Bolted Bushing Mounting Screw Torque		
Piston Rod Diameter	Cap Screw Size	** Torque
5/8	10-32 x 3/8	76 in./lbs.
1 thru 3 1/2	1/4-28 x 5/8	180 in./lbs.
4 thru 5 1/2	5/16-24 x 1	360 in./lbs.

** Reduce torque by 25% if bushing is cadmium plated.

* Recommended Torques (ft. lbs) with MoS2 lubricant or equivalent.

Miller HV Series Hydraulic Cylinders

Parts List and Seal Kits

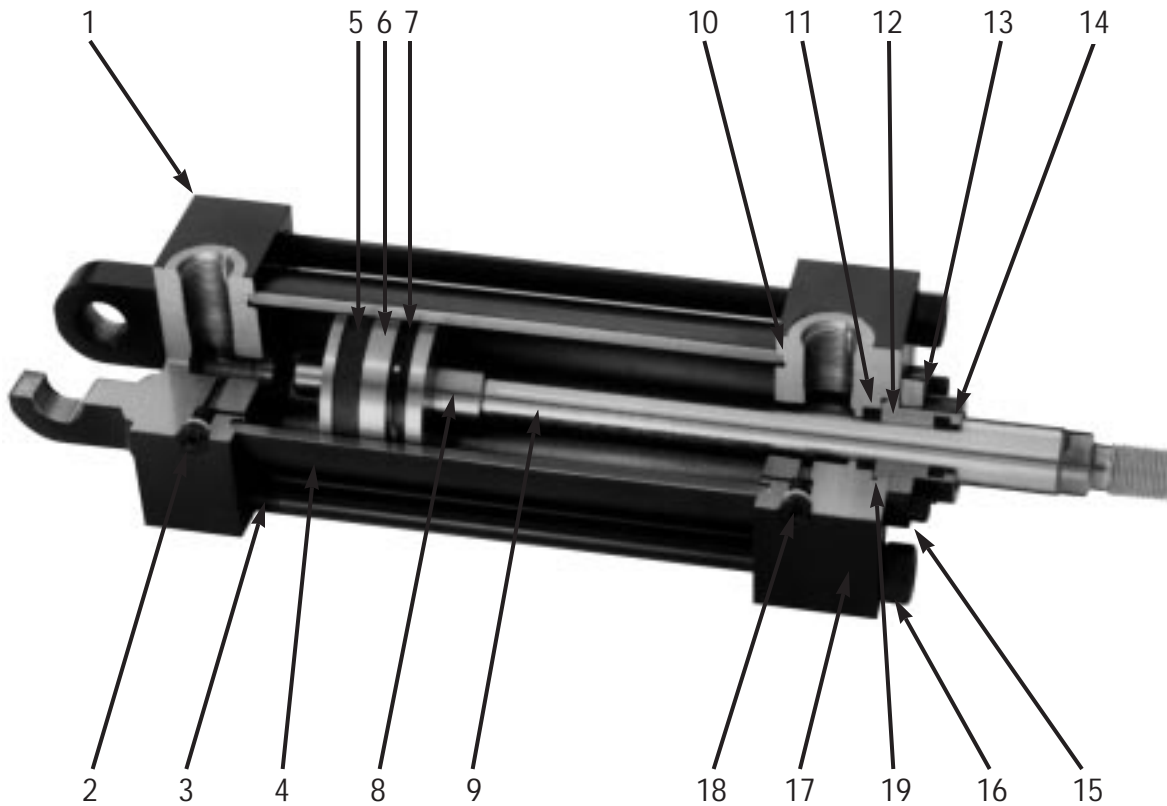

Rod Diameter	Bolted Bushing Rod Seal Kit Part # 11, 12, 13, 14, 19	Retainer Bushing Rod Seal Kit Part # 11, 12, 14, 19
5/8	051-KR065-63	051-KR064-63
1	051-KR065-100	051-KR064-100
1 3/8	051-KR065-138	051-KR064-138
1 3/4	051-KR065-175	051-KR064-175
2	051-KR065-200	051-KR064-200
2 1/2	051-KR065-250	051-KR064-250
3	051-KR065-300	051-KR064-300
3 1/2	051-KR065-350	051-KR064-350
4	051-KR065-400	051-KR064-400
4 1/2	051-KR065-450	051-KR064-450
5	051-KR065-500	051-KR064-500
5 1/2	051-KR065-550	051-KR064-550

Bore	Bore Kit Part # 5, 7, 10
1 1/2	181-KB001-150
2	181-KB001-200
2 1/2	181-KB001-250
3 1/4	181-KB001-325
4	181-KB001-400
5	181-KB001-500
6	181-KB001-600
7	181-KB001-700
8	181-KB001-800

IMPORTANT: When ordering parts, specify serial number and part name as shown. Serial number can be found on the cylinder name tag or stamped on the head and cap near the ports.

1. Cap
2. Cushion Adjustment Assembly
3. Tie Rod (4)
4. Tube
5. Wear Ring
6. Piston
7. Piston Seal
8. Rod End Cushion Plunger
9. Piston Rod
10. Tube End Seal (2)
11. Rod Seal
12. Bushing
13. Bushing Retainer
14. Rod Wiper
15. Socket Head Cap Screws
16. Tie Rod Nuts
17. Head
18. Cushion Adjustment Assembly
19. Bushing O-Ring

Miller Warranty

Subject to the conditions below, Miller Fluid Power Corporation ("Miller") warrants to the first end user (the "Buyer") that Miller's products are free from defects in material and workmanship.

Miller will either repair or replace a defective product, including lowest transportation costs but not including installation or any other similar charges, provided that (1) the buyer notifies Miller in writing of the claimed defect within one year from shipment from Miller's factory (2) provides a complete explanation of the defect, the application of the product, and such other information concerning use of the product as Miller may request, and (3) returns the product to Miller in accordance with Miller's specific written instructions and authorization obtained from Miller prior to return of the product, and Miller's inspection confirms that the product was defective.

This warranty applies only if the product was used and applied correctly under normal operating conditions and good engineering practice; was installed, operated and maintained in accordance with all instructions issued or published by Miller; was used within stated pressure, media and operating limitations published by Miller and in effect on the date of shipment; and was not subject to abuse, misuse or unauthorized modification.

THIS WARRANTY IS IN LIEU OF ALL OTHER WARRANTIES, EXPRESSED OR IMPLIED, INCLUDING ANY IMPLIED WARRANTY OF MERCHANTABILITY OR FITNESS FOR A PARTICULAR PURPOSE, not withstanding any disclosure to Miller of the use to which the product is to be put. The Buyer's SOLE AND EXCLUSIVE REMEDY on any claim of any kind for any loss or damage arising out of the manufacturer, sale, delivery or use of Miller's products shall be for the repair or replacement of any defective products as provided herein.

IN NO EVENT SHALL MILLER BE LIABLE FOR ANY SPECIAL, INCIDENTAL OR CONSEQUENTIAL DAMAGES. There are no warranties, express or implied, made by Miller other than the warranty against defects in material and workmanship set forth above, and Miller neither assumes nor authorizes any other person or firm to assume for it any other obligations or liability.

Miller HV Series Hydraulic Cylinders

How To Order

How To Order

Example: HV72B2N 004.00- 008.00 - 1.75 S 1 1 - 9

Series	Mounting Style	Bushing	Rod End Style	Cushions	Bore Dia.	Stroke	Rod Dia.	Port Type	Port Location		Modified
HV DHV (D= Dbl. Rod End)		B= Bolted Bushing R= Retainer Held Bushing	#0 (Std) #2 #3 #4 #5 #6 #7 #8 #9	** R= Rod End Cushioned C= Cap End Cushioned B= Both Ends Cushioned N= Non-Cushioned				S= SAE N= NPT	Head End 1 (Std.) 2 3 4	Cap End 1 2 3 4	0= Standard 9= Modified (See * Below)

Note: The Standard (#1) port location is at the top of the cylinder in relation to the mountings as shown on the mounting dimensional pages in this catalog. These numbered locations are shown within the end views of the cylinders for each of the mountings indicated.

** The standard cushion adjustment screw location is position #2. Ball check is position #4.

* The number 9 refers to any modifications from standard design. Non-Standard Modifications and options not identified in the part number identification above must be included on all orders.

Examples of Other Modifications and Options Include:

- Tie Rod Extensions
- Air Bleeds
- Rod End Modifications
- Special or Oversize Ports
- Keyways
- Key Retainers
- Stainless Steel Piston Rods
- Extra Heavy Chrome Plated Piston Rods
- Chrome Plated Tube I.D.
- Stop Tube
- External Drainback Rod Bushing
- Grease Fitted Rod Bushing
- Bronze Bushings
- Position Sensing Cylinder
- Special Materials
- Viton Seals
- Non-Sag Piston Rods
- Adjustable Retract Stroke
- Adjustable Advance Stroke
- Metallic Rod Scrapers
- Drilling and Tapping Modifications
- Flush Tie Rod Nuts
- Heavy Duty Rod Bushing
- Epoxy or Special Paint
- Mixed Mounting Styles
- Piston Ring Construction
- Proximity Switches
- Modifications for Special Environments
- Close Stroke Tolerances
- Port in Rear Face of Cap

For other Non-Standard Modifications, contact Miller Fluid Power Application Engineering Dept.

Miller HV Series Hydraulic Cylinders

Determining the Proper Bore Size

To find the proper bore size for your cylinder, follow these simple steps:

1. In the table below, locate the column headed by the pressure at which you plan to operate the system.
2. Move down that column and find the force or thrust value which is the same as (or next higher value) that which the cylinder will be required to deliver.
3. On the same line, move across the table to the first column. The number shown there is most likely the bore size best suited to delivering the push stroke forces you require. Later checks can confirm whether this bore size is, in fact, the one which best serves your particular application needs.

Bore Size Estimation Table

Cylinder Bores in Inches	Piston Area Square Inches	THEORETICAL PUSH STROKE FORCES IN POUNDS										Oil Consumption Per Inch of Stroke in One Direction		
		PRESSURES OF OPERATING MEDIUM										(GPI) Gals. Displaced		
		100 PSI	200 PSI	250 PSI	500 PSI	750 PSI	1000 PSI	1500 PSI	2000 PSI	3000 PSI	4000 PSI			
1½	1.767	177	353	442	884	1,325	1,767	2,651	3,534	5,301	7,068	8,835	.00765	
2	3.142	314	628	786	1,571	2,357	3,142	4,713	6,283	9,426	12,566	15,710	.01360	
2½	4.909	491	982	1,227	2,455	3,682	4,909	7,364	9,818	14,727	19,636	25,545	.0213	
3¼	8.296	830	1,659	2,074	4,148	6,222	8,296	12,444	16,592	24,888	33,184	41,480	.0359	
4	12.566	1,257	2,513	3,141	6,283	9,425	12,566	18,849	25,132	37,698	50,264	62,830	.0544	
5	19.635	1,964	3,927	4,909	9,818	14,726	19,635	29,453	39,270	58,905	78,540	98,175	.0850	
6	28.274	2,827	5,657	7,071	14,137	21,205	28,274	42,411	56,548	84,822	113,096	141,370	.1224	
7	38.485	3,849	7,697	9,621	19,242	28,864	38,485	57,728	76,970	115,455	153,940	192,425	.1666	
8	50.265	5,027	10,053	12,566	25,133	37,699	50,265	75,398	100,530	150,795	201,060	251,325	.2176	

Theoretical thrusts for operating pressures not shown in the table may be calculated by multiplying the operating pressures by the piston areas.

To determine the Gallons Per Minute required to move the piston at a required speed, use the last column on the right in the following formula:

Gallons Per Minute (GPM) = Gallons Per Inch (GPI) x Inches Per Minute Piston Speed (IPM).

Pull Stroke Cylinder Bores and Forces

To find the force on the pull stroke, you need to adjust for: "the area on the rod end of the cylinder being less than the cylinder bore by the area of the rod."

To find the force on the pull stroke, you need to know the area of the rod. Example: For a five inch bore cylinder, the standard rod diameter is two inches. Find two inches in the left most column in the chart below, move along to the right until you find the column headed by the pressure you will be working at. The number shown, is the value you deduct from the push stroke thrust, in the chart above. The resultant is the force available for the pull stroke.

Should your pressure be different from those shown in the table, then use the following formula to calculate the pull force. Pull force = (Bore Area - Rod Area) x Working Pressure.

Piston Rod Diameters in Inches	Piston Rod Area Square Inches	THEORETICAL PUSH STROKE FORCES IN POUNDS										Oil Consumption Per Inch of Stroke in One Direction		
		Deduct the following thrusts or consumptions corresponding to rod size from push stroke pressures or consumptions to determine pull stroke pressure or consumptions										(GPI) Gals. Displaced		
		PRESSURES OF OPERATING MEDIUM												
		100 PSI	200 PSI	250 PSI	500 PSI	750 PSI	1000 PSI	1500 PSI	2000 PSI	3000 PSI	4000 PSI	5000 PSI		
5/8	.307	31	61	77	154	230	307	461	614	921	1,228	1,535	.00133	
1	.785	79	157	196	393	589	785	1,176	1,570	2,355	3,140	3,925	.0034	
1¾	1.485	149	297	371	743	1,114	1,485	2,228	2,970	4,455	5,940	7,425	.00673	
1¾	2.405	241	481	601	1,203	1,804	2,405	3,608	4,810	7,215	9,620	12,025	.01041	
2	3.142	314	628	786	1,571	2,357	3,142	4,713	6,284	9,426	12,568	15,710	.01360	
2½	4.900	491	980	1,225	2,450	3,675	4,900	7,350	9,800	14,700	19,600	24,500	.0213	
3	7.069	707	1,414	1,767	3,535	5,302	7,069	10,604	14,138	21,207	28,276	35,345	.0306	
3½	9.621	962	1,924	2,405	4,811	7,216	9,621	14,432	19,242	28,863	38,484	48,105	.0417	
4	12.566	1,257	2,513	3,142	6,283	9,425	12,566	18,849	25,132	37,698	50,264	62,830	.0544	
4½	15.904	1,590	3,181	3,976	7,952	11,928	15,904	23,856	31,808	47,712	63,616	79,520	.0688	
5	19.635	1,964	3,927	4,909	9,818	14,726	19,635	29,452	39,270	58,905	78,540	98,175	.0850	
5½	23.758	2,376	4,752	5,940	11,879	17,819	23,758	35,657	47,516	71,274	95,032	118,790	.1028	

Miller Fluid Power
Main Plant
800 North York Road
Bensenville, IL 60106
(630) 766-3400—Local
(800) 323-2520—Elsewhere
(630) 350-0294—FAX

Miller Fluid Power
33067 Industrial Road
Livonia, MI 48150
(800) 323-2520

Miller Fluid Power
2050 Del Rio
Ontario, CA 91761
(800) 323-2520

Miller Fluid Power Canada Ltd.
1214 Kamato
Mississauga, Ontario, Canada L4W1Y1
(800) 268-0205—Ontario & Quebec
(905) 625-2780—Elsewhere
(905) 625-8724—FAX

Miller Potencia Fluida, S.A. de C.V.
Israel No. 301 Esq. Damasco
Col. Ricardo B. Anaya 2A. SECC
Apartado Postal F-1241
78090 San Luis Potosi, S.L.P. Mexico
(48) 21-19-21, 22, 37
(48) 21-21-60—FAX

Miller Potencia Fluida, S.A. de C.V.
Nogal No. 45—Despacho 202
Col. Sant Maria La Ribera
Delegacion: Cuauhtemoc
Mexico, D.F. 06400
(5) 547-2474
(5) 541-1123—FAX

Miller Fluid Power (UK) Ltd.
Unit 3, Bailey Drive
Norwood Industrial Estate
Killamarsh, Sheffield
South Yorkshire, England S31 8HB
441-462 438303
441-462-420901—FAX

All specifications and information subject to
change without notice or prior obligation.

File 8641 059906

