

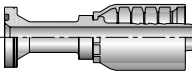
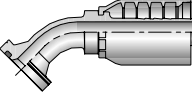
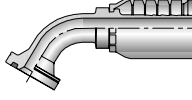
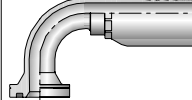

 <p>Code 62 Flange</p>	<p>16A79 B-122</p>  <p><i>Flange</i></p>	<p>16F79 B-122</p>  <p><i>45° Elbow</i></p>	<p>16G79 B-122</p>  <p><i>60° Elbow</i></p>	<p>16N79 B-123</p>  <p><i>90° Elbow</i></p>	 <p>Seal-Lok® (O-Ring Face Seal)</p>
<p>1JS79 B-123</p>  <p><i>Female - Swivel Long</i></p>	<p>1J779 B-123</p>  <p><i>Female - Swivel 45° Elbow</i></p>	<p>1J979 B-124</p>  <p><i>Female - Swivel 90° Elbow - Short</i></p>	 <p>Flange Head</p>	<p>1XA79 B-124</p>  <p><i>Flange Head</i></p>	<p>1XF79 B-124</p>  <p><i>45° Elbow</i></p>
<p>1XN79 B-124</p>  <p><i>90° Elbow</i></p>					

A

B

C

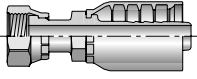
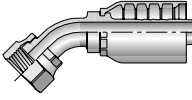
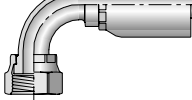
D

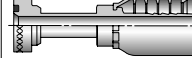
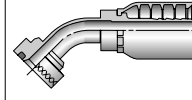
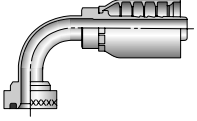
E

A

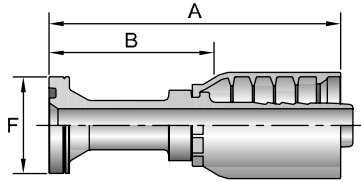

16A79

SAE Code 62 Flange Head

ISO 12151-3 - S - S

# Part Number	Flange inch	Hose I.D. inch	A		F		B	
			inch	mm	inch	inch	inch	mm
16A79-12-12	3/4	3/4	4.90	124	1-5/8	2.84	72	
16A79-16-12	1	3/4	3.88	99	1-7/8	1.82	46	
16A79-16-16	1	1	5.48	139	1-7/8	3.31	84	
16A79-20-16	1-1/4	1	4.28	109	2-1/8	2.11	54	
16A79-20-20	1-1/4	1-1/4	6.09	155	2-1/8	3.41	87	
16A79-24-24	1-1/2	1-1/2	7.11	181	1-1/2	4.07	103	

B

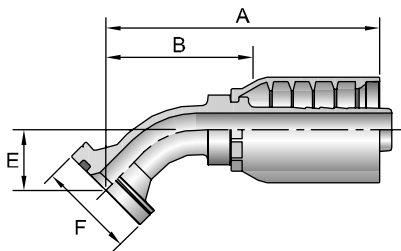

16F79

SAE Code 62 Flange Head - 45° Elbow

ISO 12151-3 - E45S - S (1 Piece: ISO 12151-3 - E45M - S)

# Part Number	Flange inch	Hose I.D. inch	A		E		F		B	
			inch	mm	inch	mm	inch	inch	inch	mm
16F79-12-12	3/4	3/4	4.61	117	1.02	26	1-5/8	2.55	65	
16F79-16-16	1	1	5.33	135	1.26	32	1-7/8	3.16	80	
16F79-16-20	1	1-1/4	6.25	159	1.50	38	1-7/8	3.57	91	
16F79-20-16	1-1/4	1	5.33	135	1.26	32	2-1/8	3.16	80	
16F79-20-20	1-1/4	1-1/4	6.77	172	1.50	38	2-1/8	4.09	104	
16F79-24-24	1-1/2	1-1/2	7.96	202	1.73	44	2-1/2	4.07	103	

C

D

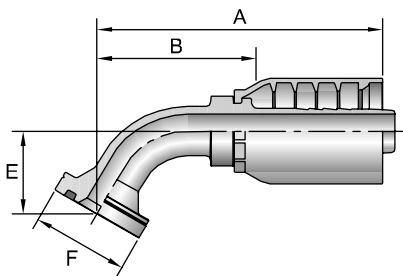

16G79

SAE Code 62 Flange Head - 60° Elbow

ISO 12151-3 - E60S - S (1 Piece: ISO 12151-3 - E60M - S)

# Part Number	Flange inch	Hose I.D. inch	A		E		F		B	
			inch	mm	inch	mm	inch	inch	inch	mm
16G79-16-16	1	1	6.18	157	1.73	44	1-7/8	4.01	102	

E

See Accessories Section for O-Rings and Flange Kits.

16N79

SAE Code 62 Flange Head - 90° Elbow

ISO 12151-3 - E90S - S (1 Piece: ISO 12151-3 - E90M - S)

# Part Number	Flange inch	Hose I.D. inch	A		E		F		B	
			inch	mm	inch	mm	inch	mm	inch	mm
16N79-12-12	3/4	3/4	4.27	108	2.28	58	1-5/8	2.21	56	
16N79-16-12	1	3/4	4.27	108	2.28	58	1-7/8	2.21	56	
16N79-16-16	1	1	4.95	126	2.76	70	1-7/8	2.78	71	
16N79-20-16	1-1/4	1	4.95	126	2.76	70	2-1/8	2.78	71	
16N79-20-20	1-1/4	1-1/4	6.31	160	3.54	90	2-1/8	3.63	92	
16N79-24-24	1-1/2	1-1/2	7.50	190	4.09	104	2-1/2	4.46	113	

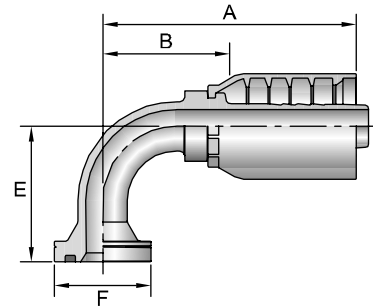

1JS79

Female Seal-Lok® - Swivel - Long

ISO 12151-1 - SWSB

# Part Number	Thread inch	Hose I.D. inch	A		H inch	W inch	B		
			inch	mm			inch	mm	
1JS79-12-12	3/4	1-3/16x12	3/4	3.99	101	1-1/8	1-3/8	1.93	49
1JS79-16-12	1	1-7/16x12	3/4	4.26	108	1-3/8	1-5/8	2.20	56
1JS79-16-16	1	1-7/16x12	1	4.45	113	1-3/8	1-5/8	2.28	58
1JS79-20-16	1-1/4	1-11/16x12	1	4.32	110	1-3/4	1-7/8	2.15	55
1JS79-20-20	1-1/4	1-11/16x12	1-1/4	5.00	127	1-3/4	1-7/8	2.32	59
1JS79-24-24	1-1/2	2x12	1-1/2	5.28	134	2	2-1/4	2.24	57

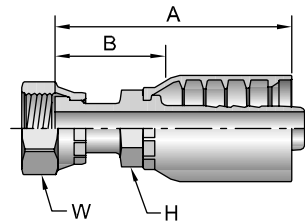

⚠ Refer to Pressure Rating of Hose End Connections chart on page E-43.

1J779

Female Seal-Lok® - Swivel - 45° Elbow

ISO 12151-1 - SWE45

# Part Number	Thread inch	Hose I.D. inch	A		E		W inch	B		
			inch	mm	inch	mm		inch	mm	
1J779-12-12	3/4	1-3/16x12	3/4	4.40	112	0.83	21	1-3/8	2.34	59
1J779-16-16	1	1-7/16x12	1	5.01	127	0.94	24	1-5/8	2.84	72
1J779-20-20	1-1/4	1-11/16x12	1-1/4	6.15	156	1.00	25	1-7/8	3.49	89

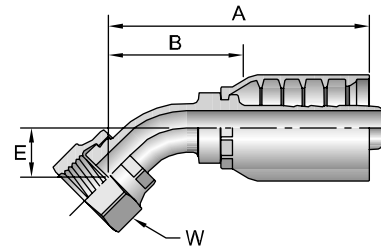

⚠ Refer to Pressure Rating of Hose End Connections chart on page E-43.

See Accessories Section for O-Rings and Flange Kits.

A

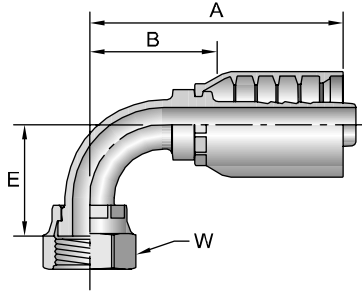

1J979

Female Seal-Lok® - Swivel - 90° Elbow - Short Drop
ISO - 12151-1 - SWES90

# Part Number	Thread		Hose I.D. inch	A		E		W		B	
	inch	inch		inch	mm	inch	mm	inch	mm	inch	mm
1J979-12-12	3/4	1-3/16x12	3/4	4.27	108	1.88	48	1-3/8	2.21	56	
1J979-16-16	1	1-7/16x12	1	4.95	126	2.21	56	1-5/8	2.78	71	
1J979-20-20	1-1/4	1-11/16x12	1-1/4	6.20	157	2.52	64	1-7/8	3.52	89	

⚠ Refer to Pressure Rating of Hose End Connections chart on page E-43

B

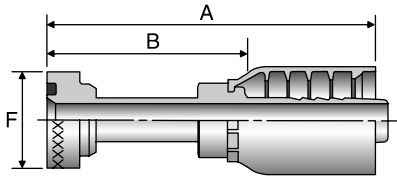

1XA79

Caterpillar® Flange Head

# Part Number	Flange inch	Hose I.D. inch	A		F		B	
			inch	mm	inch	mm	inch	mm
1XA79-12-12	3/4	3/4	4.89	124	1-5/8	2.83	72	
1XA79-16-16	1	1	5.75	146	1-7/8	3.59	91	
1XA79-20-16	1-1/4	1	4.32	110	2-1/8	2.15	55	
1XA79-20-20	1-1/4	1-1/4	6.25	159	2-1/8	3.57	91	
1XA79-24-24	1-1/2	1-1/2	7.17	182	2-1/2	4.13	105	

C

1XF79

Caterpillar® Flange Head - 45° Elbow

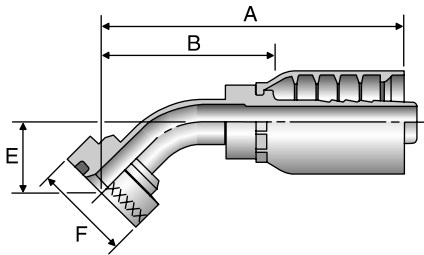

# Part Number	Flange inch	Hose I.D. inch	A		E		F		B	
			inch	mm	inch	mm	inch	mm	inch	mm
1XF79-12-12	3/4	3/4	4.80	122	1.22	31	1-5/8	2.74	70	
1XF79-16-16	1	1	5.49	139	1.42	36	1-7/8	3.32	84	
1XF79-20-16	1-1/4	1	5.49	139	1.42	36	2-1/8	3.32	84	
1XF79-20-20	1-1/4	1-1/4	6.72	171	1.44	37	2-1/8	4.04	103	

D

E

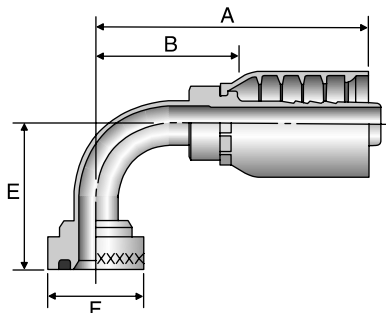

1XN79

Caterpillar® Flange Head - 90° Elbow

# Part Number	Flange inch	Hose I.D. inch	A		E		F		B	
			inch	mm	inch	mm	inch	mm	inch	mm
1XN79-12-12	3/4	3/4	4.27	108	2.48	63	1-5/8	2.21	56	
1XN79-16-16	1	1	4.94	125	2.91	74	1-7/8	2.78	71	
1XN79-20-16	1-1/4	1	4.94	125	2.91	74	2-1/8	2.78	71	
1XN79-20-20	1-1/4	1-1/4	6.31	160	3.70	94	2-1/8	3.63	92	
1XN79-24-24	1-1/2	1-1/2	7.50	191	4.16	106	2-1/2	4.46	113	

See Accessories Section for O-Rings and Flange Kits.

A

B

C

D

E