

514C DC Controller

Product Manual

HA463296 Issue 6

© Copyright 2007 Parker SSD Drives, a division of Parker Hannifin Ltd.

All rights strictly reserved. No part of this document may be stored in a retrieval system, or transmitted in any form or by any means to persons not employed by a Parker SSD Drives company without written permission from Parker SSD Drives, a division of Parker Hannifin Ltd. Although every effort has been taken to ensure the accuracy of this document it may be necessary, without notice, to make amendments or correct omissions. Parker SSD Drives cannot accept responsibility for damage, injury, or expenses resulting therefrom.

WARRANTY

Parker SSD Drives warrants the goods against defects in design, materials and workmanship for the period of 12 months from the date of delivery on the terms detailed in Parker SSD Drives Standard Conditions of Sale IA058393C.

Parker SSD Drives reserves the right to change the content and product specification without notice.

Safety Information



Requirements

IMPORTANT: Please read this information BEFORE installing the equipment.

Intended Users

This manual is to be made available to all persons who are required to install, configure or service equipment described herein, or any other associated operation.

The information given is intended to highlight safety issues, EMC considerations, and to enable the user to obtain maximum benefit from the equipment.

Complete the following table for future reference detailing how the unit is to be installed and used.

INSTALLATION DETAILS	
Serial Number <i>(see product label)</i>	
Where installed <i>(for your own information)</i>	
Unit used as a: <i>(refer to Certification for the Inverter)</i>	<input type="checkbox"/> Component <input type="checkbox"/> Relevant Apparatus
Unit fitted:	<input type="checkbox"/> Wall-mounted <input type="checkbox"/> Enclosure



Application Area

The equipment described is intended for industrial motor speed control utilising AC induction or AC synchronous machines.

Personnel

Installation, operation and maintenance of the equipment should be carried out by qualified personnel. A qualified person is someone who is technically competent and familiar with all safety information and established safety practices; with the installation process, operation and maintenance of this equipment; and with all the hazards involved.

Product Warnings

	<p>Caution Risk of electric shock</p>		<p>Caution Refer to documentation</p>		<p>Earth/Ground Protective Conductor Terminal</p>
---	--	---	--	---	--

Safety Information



Hazards

DANGER! - Ignoring the following may result in injury

1. This equipment can endanger life by exposure to rotating machinery and high voltages.
2. The equipment must be permanently earthed due to the high earth leakage current, and the drive motor must be connected to an appropriate safety earth.
3. Ensure all incoming supplies are isolated before working on the equipment. Be aware that there may be more than one supply connection to the drive.
4. There may still be dangerous voltages present at power terminals (motor output, supply input phases, DC bus and the brake, where fitted) when the motor is at standstill or is stopped.
5. For measurements use only a meter to IEC 61010 (CAT III or higher). Always begin using the highest range. CAT I and CAT II meters must not be used on this product.
6. Allow at least 5 minutes for the drive's capacitors to discharge to safe voltage levels (<50V). Use the specified meter capable of measuring up to 1000V dc & ac rms to confirm that less than 50V is present between all power terminals and earth.
7. Unless otherwise stated, this product must NOT be dismantled. In the event of a fault the drive must be returned. Refer to "Routine Maintenance and Repair".

WARNING! - Ignoring the following may result in injury or damage to equipment

SAFETY

Where there is conflict between EMC and Safety requirements, personnel safety shall always take precedence.

- Never perform high voltage resistance checks on the wiring without first disconnecting the drive from the circuit being tested.
- Whilst ensuring ventilation is sufficient, provide guarding and /or additional safety systems to prevent injury or damage to equipment.
- When replacing a drive in an application and before returning to use, it is essential that all user defined parameters for the product's operation are correctly installed.
- All control and signal terminals are SELV, i.e. protected by double insulation. Ensure all external wiring is rated for the highest system voltage.
- Thermal sensors contained within the motor must have at least basic insulation.
- All exposed metalwork in the Inverter is protected by basic insulation and bonded to a safety earth.
- RCDs are not recommended for use with this product but, where their use is mandatory, only Type B RCDs should be used.

EMC

- In a domestic environment this product may cause radio interference in which case supplementary mitigation measures may be required.
- This equipment contains electrostatic discharge (ESD) sensitive parts. Observe static control precautions when handling, installing and servicing this product.
- This is a product of the restricted sales distribution class according to IEC 61800-3. It is designated as "professional equipment" as defined in EN61000-3-2. Permission of the supply authority shall be obtained before connection to the low voltage supply.

CAUTION!

APPLICATION RISK

- The specifications, processes and circuitry described herein are for guidance only and may need to be adapted to the user's specific application. We can not guarantee the suitability of the equipment described in this Manual for individual applications.

RISK ASSESSMENT

Under fault conditions, power loss or unintended operating conditions, the drive may not operate as intended. In particular:

- Stored energy might not discharge to safe levels as quickly as suggested, and can still be present even though the drive appears to be switched off
- The motor's direction of rotation might not be controlled
- The motor speed might not be controlled
- The motor might be energised

A drive is a component within a drive system that may influence its operation or effects under a fault condition. Consideration must be given to:

- Stored energy
- Supply disconnects
- Sequencing logic
- Unintended operation

514C

Contents

Chapter 1 Product Overview	1
Description	1
Product Range	1
540 TO 514C upgrade.....	1
European Directives and the CE Mark	1
Certificates	6
Product Identification.....	7
Technical Specification	8
Environmental Requirements	10
EMC Technical Ratings	11
Product Code	11
Chapter 2 Pre-Installation Planning	2-1
Basic Wiring Diagrams.....	2-1
Terminal Descriptions.....	2-2
Terminal Comparison 540/1 to 514C	2-4
Block Diagram	2-1
Functional Differences 514C - 540	2-2
Chapter 3 Installation Procedure	3-1
Installation Precautions.....	3-1
Mechanical Installation.....	3-1
Electrical Installation	3-3
Requirements for UL Compliance.....	3-5
Chapter 4 Setting-Up & Commissioning	4-1
Option Switches.....	4-1
Potentiometers	4-2
Basic Setting-up Procedure	4-3
Running Performance Adjustments	4-7
Chapter 5 Diagnostics and Fault Finding	5-1
Diagnostic Leds	5-1
Drive Trips.....	5-2
Diagnostic Test Point Descriptions	5-2
Troubleshooting.....	5-4
Chapter 6 Service and Repair	6-1
DISPOSAL	6-1

Chapter 1 Product Overview

DESCRIPTION

The 514C controller is intended for use in an Industrial Environment, it should be mounted within an enclosure which provides protection to the controller and the user.

The controller should be permanently earthed at the terminals provided.

The 514C controller is designed to control the speed of a DC Shunt wound or permanent magnet motor. It will provide control of the motor speed in all 4 Quadrants of operation.

The controllers are designed to operate from a single phase AC mains supply in the range of 110 Vac to 415 Vac at 50 or 60 Hz. An auxiliary supply is required for internal power supply generation and main supply contactor sequencing. Coding is derived from the main power terminals and is functional over the whole input voltage range.

The Speed of the DC Motor is controlled using a linear closed loop system with a feedback signal from either tachogenerator or armature voltage, the feedback source being switch selectable.

A current loop within the speed loop always ensures that controlled levels of current are applied to the motor, actual levels being scaleable via programmable switches.

Motor protection is provided by a Stall detection circuit which will remove current from the motor after approximately 60 seconds.

Controller protection is provided by a Instantaneous Overcurrent trip circuit overriding control in the event of a Short Circuit.

PRODUCT RANGE

Product	Rating
514C/04	4A DC Full Load Current
514C/08	8A DC Full Load Current
514C/16	16A DC Full Load Current
514C/32	32A DC Full Load Current

540 TO 514C UPGRADE

The 514C is designed to be functionally equivalent to the 540 series controllers not a direct replacement. Comparisons between the two controllers connectors are included throughout the manual.

Chapter 2 describes the terminal connectors to the 514C controller, in that section on page 2.4 is given a terminal to terminal comparison of 540/1 to 514C.

EUROPEAN DIRECTIVES AND THE CE MARK

The following information is supplied to provide a basic understanding of the EMC and low voltage directives CE marking requirements. The following literature is recommended for further information:

- *Recommendations for Application of Power Drive Systems (PDS), European Council Directives - CE Marking and Technical Standardisation - (CEMEP)*

Available from your local trade association or Parker SSD Drives office

- *EMC Installation Guidelines for Modules and Systems - (SSD Drives)*

Available from your local Parker SSD Drives office, part number HA388879

- *Short Form Overview of European Directives for Variable Speed Drives and Applications - (SSD Drives)*

Available from your local Parker SSD Drives office, part number HA389770

The European machines and drives manufacturers via their national trade associations have formed the European Committee of Manufacturers of Electrical Machines and Power Electronics (CEMEP). Parker SSD Drives and other major European drives manufacturers are working to the CEMEP recommendations on CE marking. The CE mark shows that a product complies with the relevant EU directives, in our case the Low Voltage Directive and, in some instances, the EMC Directive.

CE Marking for Low Voltage Directive

When installed in accordance with this manual, the 590 Series Converter is CE marked by Parker SSD Drives Ltd in accordance with the low voltage directive (S.I. No. 3260 implements this LVD directive into UK law). An EC Declaration of Conformity (low voltage directive) is included at the end of this chapter.

CE Marking for EMC - Who is Responsible?

NOTE: THE SPECIFIED EMC EMISSION AND IMMUNITY PERFORMANCE OF THIS UNIT CAN ONLY BE ACHIEVED WHEN THE UNIT IS INSTALLED TO THE EMC INSTALLATION INSTRUCTIONS GIVEN IN THIS MANUAL.

According to S.I. No. 2373 which implements the EMC directive into UK law, the requirement for CE marking this unit falls into two categories:

1. Where the supplied unit has an intrinsic/direct function to the end user, then the unit is classed as *relevant apparatus*.
2. Where the supplied unit is incorporated into a higher system/apparatus or machine which includes (at least) the motor, cable and a driven load but is unable to function without this unit, then the unit is classed as a *component*.

■ Relevant Apparatus - Parker SSD Drives Responsibility

Occasionally, say in a case where an existing fixed speed motor - such as a fan or pump - is converted to variable speed with an add-on drive module (*relevant apparatus*), it becomes the responsibility of Parker SSD Drives to apply the CE mark and issue an EC Declaration of Conformity for the EMC Directive. This declaration and the CE mark is included at the end of this chapter.

■ Component - Customer Responsibility

The majority of Parker SSD Drives' products are classed as *components* and therefore we cannot apply the CE mark or produce an EC Declaration of Conformity in respect of EMC. It is therefore the manufacturer/supplier/installer of the higher system/apparatus or machine who must conform to the EMC directive and CE mark.

Legal Requirements for CE Marking

IMPORTANT: Before installation, clearly understand who is responsible for conformance with the EMC directive. Misappropriation of the CE mark is a criminal offence.

It is important that you have now defined who is responsible for conforming to the EMC directive, either:

■ Parker SSD Drives Responsibility

You intend to use the unit as *relevant apparatus*.

When the specified EMC filter is correctly fitted to the unit following EMC installation instructions, it complies with the relevant standards indicated in the following tables. The fitting of the filter is mandatory for the CE marking of this unit to apply.

The relevant declarations are to be found at the end of this chapter. The CE mark is displayed on the EC Declaration of Conformity (EMC Directive) provided at the end of this chapter.

■ Customer Responsibility

You intend to use the unit as a *component*, therefore you have a choice:

1. To fit the specified filter following EMC installation instructions, which may help you gain EMC compliance for the final machine/system.
2. Not to fit the specified filter, but use a combination of global or local filtering and screening methods, natural migration through distance, or the use of distributed parasitic elements of the existing installation.

NOTE: WHEN TWO OR MORE EMC COMPLIANT COMPONENTS ARE COMBINED TO FORM THE FINAL MACHINE/SYSTEM, THE RESULTING MACHINE/SYSTEM MAY NO LONGER BE COMPLIANT, (EMISSIONS TEND TO BE ADDITIVE, IMMUNITY IS DETERMINED BY THE LEAST IMMUNE COMPONENT). UNDERSTAND THE EMC ENVIRONMENT AND APPLICABLE STANDARDS TO KEEP ADDITIONAL COMPLIANCE COSTS TO A MINIMUM.

Applying for CE Marking for EMC

We have supplied a Manufacturer's EMC Declaration at the end of this chapter that you can use as a basis for your own justification of overall compliance with the EMC directive. There are three methods of demonstrating conformity:

1. Self-certification to a relevant standard
2. Third party testing to a relevant standard
3. Writing a technical construction file stating the technical rationale as to why your final machine/system is compliant. An EMC "competent body" must then assess this and issue a technical report or certificate to demonstrate compliance.
Refer to Article 10(2) of Directive 89/336/EEC.

With EMC compliance, an EC Declaration of Conformity and the CE mark will be issued for your final machine/system.

IMPORTANT: Professional end users with EMC expertise who are using drive modules and cubicle systems defined as components who supply, place on the market or install the relevant apparatus must take responsibility for demonstrating EMC conformance and applying the CE mark and issuing an EC Declaration of Conformity.

Which Standards Apply?

Basic and Generic Standards

The standards that may apply to this unit come under two broad categories:

1. Emission - these standards limit the interference caused by operating (this) drive module.
2. Immunity - these standards limit the effect of interference (on this unit) from other electrical and electronic apparatus.

The following table indicates the standards that the unit may comply with, dependent upon how it is installed and used.

Assuming installation to EMC instructions in this manual
 "Filter" refers to a specified external filter.



Installation	Basic and Generic Standards		Unit used as Relevant Apparatus		Unit used as a Component	
			filter (EMC compliance)	no filter	filter (EMC compliance may be applied for)	no filter
			enclosure	enclosure	enclosure	enclosure
Residential 	Radiated RF Emission	EN55022 Class B (1994) or EN50081-1 (1992)	✓	✓	✓	✓
	Conducted RF Emission	EN55022 Class B (1994) or EN50081-1 (1992)				
	Immunity	EN50082-1 (1992)	✓	✓	✓	✓
Commercial & Light Industry 	Radiated RF Emission	EN55022 Class B (1994) or EN50081-1 (1992)	✓	✓	✓	✓
	Conducted RF Emission	EN55022 Class B (1994) or EN50081-1 (1992)				
	Immunity	EN50082-1 (1992)	✓	✓	✓	✓
Industrial 	Radiated RF Emission	EN55011 Class A (1991) or EN50081-2 (1994)	✓	✓	✓	✓
	Conducted RF Emission	EN55011 Class A (1991) or EN50081-2 (1994)	✓		✓	
	Immunity	prEN50082-2 (1992)	✓	✓	✓	✓

Table 1-1 Applicable Basic and Generic Standards

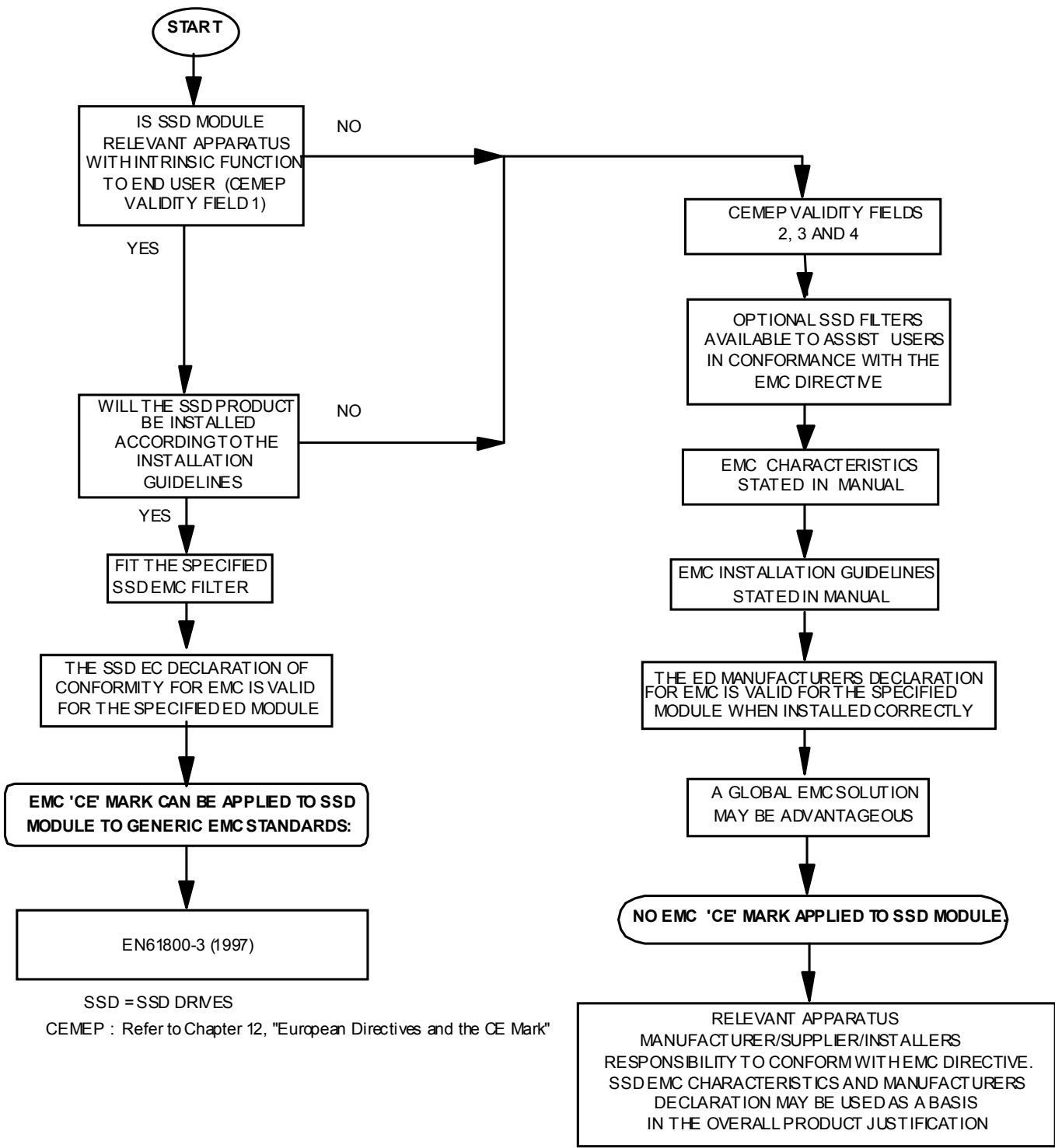



Figure 1-1 Parker SSD Drives EMC 'CE' Mark Validity Chart

CERTIFICATES

514C	
<div style="display: flex; justify-content: space-between; align-items: center;"> <div style="font-size: 2em; font-weight: bold;">CE</div> <div style="text-align: center;"> <p>EC DECLARATIONS OF CONFORMITY</p> <p>Date CE marked first applied: 01.04.2000</p> </div> </div>	
<p style="text-align: center; background-color: black; color: white; margin-bottom: 5px;">EMC Directive</p> <p style="text-align: center;">In accordance with the EEC Directive 2004/108/EC</p> <p>We Parker SSD Drives, address as below, declare under our sole responsibility that the above Electronic Products when installed and operated with reference to the instructions in the Product Manual (provided with each piece of equipment) is in accordance with the relevant clauses from the following standard:-</p> <p style="text-align: center;">* BSEN61800-3 (2004)</p>	<p style="text-align: center; background-color: black; color: white; margin-bottom: 5px;">Low Voltage Directive</p> <p style="text-align: center;">In accordance with the EEC Directive 2006/95/EC</p> <p>We Parker SSD Drives, address as below, declare under our sole responsibility that the above Electronic Products when installed and operated with reference to the instructions in the Product Manual (provided with each piece of equipment), is in accordance with the relevant clauses from the following standard :-</p> <p style="text-align: center;">EN50178 (1998)</p>
<p>MANUFACTURERS DECLARATIONS</p>	
<p style="text-align: center; background-color: black; color: white; margin-bottom: 5px;">EMC Declaration</p> <p>We Parker SSD Drives, address as below, declare under our sole responsibility that the above Electronic Products when installed and operated with reference to the instructions in the Product Manual (provided with each piece of equipment) is in accordance with the relevant clauses from the following standard:-</p> <p style="text-align: center;">* BSEN61800-3 (2004)</p>	<p style="text-align: center; background-color: black; color: white; margin-bottom: 5px;">Machinery Directive</p> <p>The above Electronic Products are components to be incorporated into machinery and may not be operated alone. The complete machinery or installation using this equipment may only be put into service when the safety considerations of the Directive 89/392/EEC are fully adhered to.</p> <p>Particular reference should be made to EN60204-1 (Safety of Machinery - Electrical Equipment of Machines).</p> <p>All instructions, warnings and safety information of the Product Manual must be adhered to.</p>
 <hr style="width: 20%; margin: 0 auto;"/> <p>Dr Martin Payn (Conformance Officer)</p>	
<p>* Compliant with the immunity requirements of the Standard without specified EMC filters. * 690PB only when fitted with an internal or external filter.</p>	
<p>PARKER SSD DRIVES NEW COURTWICK LANE, LITTLEHAMPTON, WEST SUSSEX BN17 7RZ TELEPHONE: +44(0)1903 737000 FAX: +44(0)1903 737100</p> <p style="font-size: 0.8em;">Registered Number: 4806503 England. Registered Office: 55 Maylands Avenue, Hemel Hempstead, Herts HP2 4SJ</p>	

Issued for compliance with the EMC Directive when the unit is used as *relevant apparatus*.

The drive is CE marked in accordance with the low voltage directive for electrical equipment and appliances in the voltage range when installed correctly.

This is provided to aid your justification for EMC compliance when the unit is used as a *component*.

Since the potential hazards are mainly electrical rather than mechanical, the drive does not fall under the machinery directive. However, we do supply a manufacturer's declaration for when the drive is used (as a *component*) in machinery.

PRODUCT IDENTIFICATION

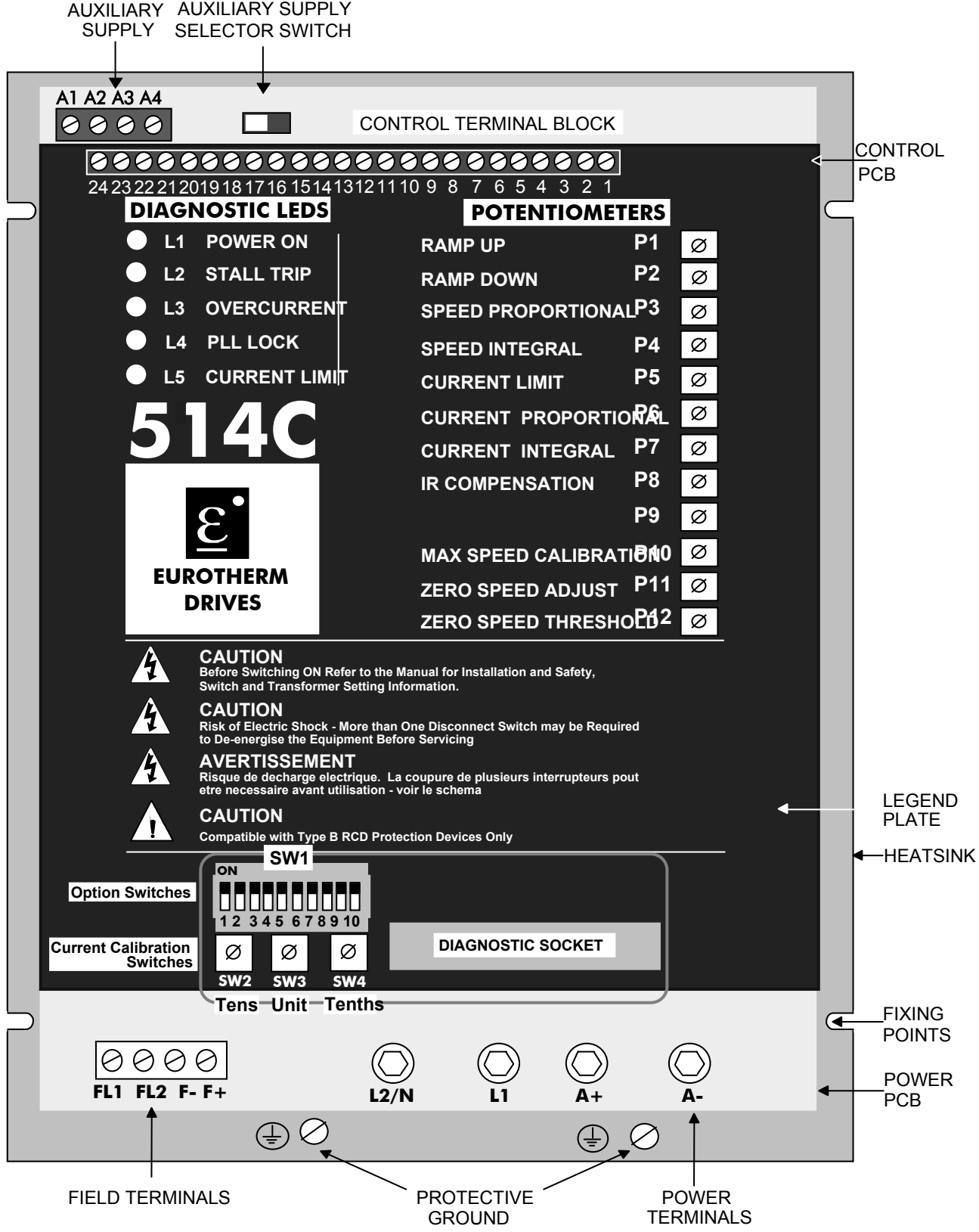

TECHNICAL SPECIFICATION

General

SPEED CONTROL

Control Action	Closed Loop with Proportional Integral Control and Adjustable Stability	
Speed Feedback	Armature Voltage	Tachogenerator
100% Load Regulation	2 % Typical	0.1 % Typical
Maximum Torque/Speed Range	20:1	100:1
Overload	150% for 60 seconds.	

TORQUE CONTROL

Control Action	Closed Loop with Proportional Integral Control.
Accuracy	2 %
Overspeed	Inherent.
Overload	None 100% continuous (consideration must be given to motor when operating at low speed).

INPUTS / OUTPUTS

Analogue Inputs	Setpoint Ramp	0 to $\pm 10V$	100 Kohm
	Positive Trim Setpoint	0 to $\pm 10V$	100 Kohm
	Negative Trim Setpoint	0 to $\pm 10V$	100 Kohm
	Current Limit	0 to +7.5V	50 Kohm
	Current Demand	0 to $\pm 10V$	100 Kohm
	Tachogenerator Input	0 to $\pm 350Vdc$	220 Kohm
	Thermistor / Microtherm Input	<200 ohm = Normal >1800 ohm = Overtemperature	5 Kohm
Analogue Outputs	Setpoint Ramp	0 to $\pm 10V$	5 mA
	Total Setpoint	0 to $\pm 10V$	5 mA
	Speed	0 to $\pm 10V$	5 mA
	Current Demand	0 to $\pm 10V$	5 mA
	Current Meter Bipolar or Modulus	0 to $\pm 5V$ (0 to 1cal) See SW1/8	5 mA
	+10V Reference	+10V	5 mA
	-10V Reference	-10V	5 mA
Digital Inputs	Run	+10 to +24V	100 Kohm
	Enable	+10 to +24V	100 Kohm
	Stall Override	+10	100 Kohm
Digital Outputs	Health	+24V	50 mA Source
	Zero Speed or Setpoint	+24V	50 mA Source

Electrical Ratings

INPUT RATINGS	SYMBOL	514C/04	514C/08	514C/16	514C/32
Supply Voltage	Vs	110 - 480 Vac ± 10%			
Maximum Supply Voltage (Derived from Three Phase Supply)		480Vac L - L Non earth referenced (IT) or earth referenced (TN) 480Vac L - N Earth referenced (TN)			
Supply Current	Is	6A	12A	24A	48A
Supply Frequency	fs	50/60 Hz ñ 5 Hz			
Auxiliary Supply	Vaux	110/120 or 220/240 Vac ± 10%			
Aux. Supply Current	Iaux	3A (Includes Contactor Coil Current)			
Contactor Coil Current		3A Maximum			
Installation Category		Overvoltage Category III			
Earth Leakage Current at 480Vac		Without Filter - 5mA ⁽¹⁾ With Filter - 50mA			

OUTPUT RATINGS					
Nominal Armature Voltage	Va	90 Vdc at 110/120 Vac 180 Vdc at 220/240 Vac 320 Vdc at 380/415 Vac			
Maximum Armature Current	Ia	4A dc ±10%	8A dc ±10%	16A dc ±10%	32A dc ±10%
Armature Current Calibration 100%	Ical	0.1 to 4A in 0.1A steps	0.1 to 8A in 0.1A steps	0.1 to 16A in 0.1A steps	0.1 to 32A in 0.1A steps
Nominal Motor Power at 320 Vdc Armature	Pm HP	1.125kW 1½ HP	2.25 kW 3 HP	4.5 kW 6 HP	9 kW 12 HP
Overload		150% for 60 seconds			
Field Current	If	3 A dc			
Field Voltage	Vf	0.9 X Supply Voltage (Vs)			
Maximum Armature Form Factor		1.5			
Thyristor I²t		300 A²s			
Typical Controller Dissipation at Ia 100%		15W ⁽²⁾	25W ⁽²⁾	50W ⁽²⁾	75W ⁽²⁾
UL Listed Rating @ 180V dc	HP	½ HP	1 HP	3 HP	5 HP

- Notes:- (1) Permanent earthing mandatory.
(2) See page 3-2 for filter watt loss information.

Mechanical

	514C/04	514C/08	514C/16	514C/32
Overall Width	160mm			
Overall Height	240mm			
Overall Depth	90mm	90mm	130mm	130mm
Weight	1.6Kg	1.6Kg	3.0Kg	3.0Kg
Airflow Clearance	75mm Above and Below			
Mounting Centres	210mm Vertical x 148mm Horizontal			
Control Terminals - 1 to 24	Screw Terminals will accept 2.5mm ² stranded wire. Terminal Tightening Torque 0.45 Nm, 4.0 lbf-in.			
Auxiliary Supply Terminals - A1 to A4	Screw Terminals will accept 4mm ² stranded wire. Terminal Tightening Torque 0.5 Nm, 4.5 lbf-in.			
Field Terminals - FL1, FL2, F-, F+	Screw Terminals will accept 4mm ² stranded wire. Terminal Tightening Torque 0.5 Nm, 4.5 lbf-in.			
Power Terminals - L2/N, L1, A+, A-	M5 Studs with Clamp. Terminal Tightening Torque 2.7 Nm, 24 lbf-in.			
Earth (Grounding) Terminals 	M5 Cheese Head Screw. Terminal Tightening Torque 7.1 Nm, 63 lbf-in.			

ENVIRONMENTAL REQUIREMENTS

Enclosure	Chassis Mounting IP00 (UL open-type)
Operating Temperature	0 to +40°C. (Derate 1.5%/Degree above 40°C).
Humidity	85% R.H. at 40°C. (Non-condensing).
Altitude	Above 1000m derate at 1% / 100m.
Storage Temperature	-25°C to +55°C.
Pollution	Pollution Degree 2.
Transport Temperature	-25°C to +70°C.
Overvoltage	III

EMC TECHNICAL RATINGS

Immunity

Port	Phenomenon	Test Standard	Level	Criterion	Generic Standard
Enclosure Port	ESD RF Field	BS EN 61000-4-2 (1995)	8kV AD 10V/m, 1kHz, AM	Self Recovery No Change	EN50082-1 (1992), and EN50082-2 (1995)
	RF Field Pulse Modulation	ENV 50140 ENV 50204	10 V/m P.M.	Self Recovery	
Power Ports	Fast Transient Burst	BS EN 61000-4-4 (1995)	2kV	Self Recovery	
	Bulk Current Injection	ENV 50141	10V, 1kHz, AM	No Change	
	Surge Test	BS EN 61000-4-5 (1995)	2kV Common Mode 2kV Differential Mode	Self Recovery	
Signal & Control	Fast Transient Burst	BS EN 61000-4-4 (1995)	2kV	Self Recovery	
	Bulk Current Injection	ENV 50141	10V, 1kHz, AM	No Change	
Power Interfaces	Fast Transient Burst	BS EN 61000-4-4 (1995)	2kV	Self Recovery	
	Bulk Current Injection	ENV 50141	10V, 1kHz, AM	No Change	

Emissions

Port	Phenomenon	Test Standard	Level	Generic Standard
Enclosure Port	Radiated	EN55011	Class B #	EN50081-1 (1992), EN50081-2 (1994)
Power Port	Conducted	EN55011	Class B *	

Notes: These levels of performance are achieved when installed as specified with the recommended Supply Filter.

* Achieved with up to 50m of motor cable. # Achieved with unscreened signal and control cables.

PRODUCT CODE

Block	Product	Code	Feature
1	Basic Product	514C	
2	Current Rating	04	4 amp
		08	8 amp
		16	16 amp
		32	32 amp
3	Livery	00	Standard
		01 to 99	Customer
4	Cover	00	IP00 Open Frame
5	Special Options	00	Standard
		01-99	Documented Special Options

Chapter 2 Pre-Installation Planning

BASIC WIRING DIAGRAMS

Basic Connection

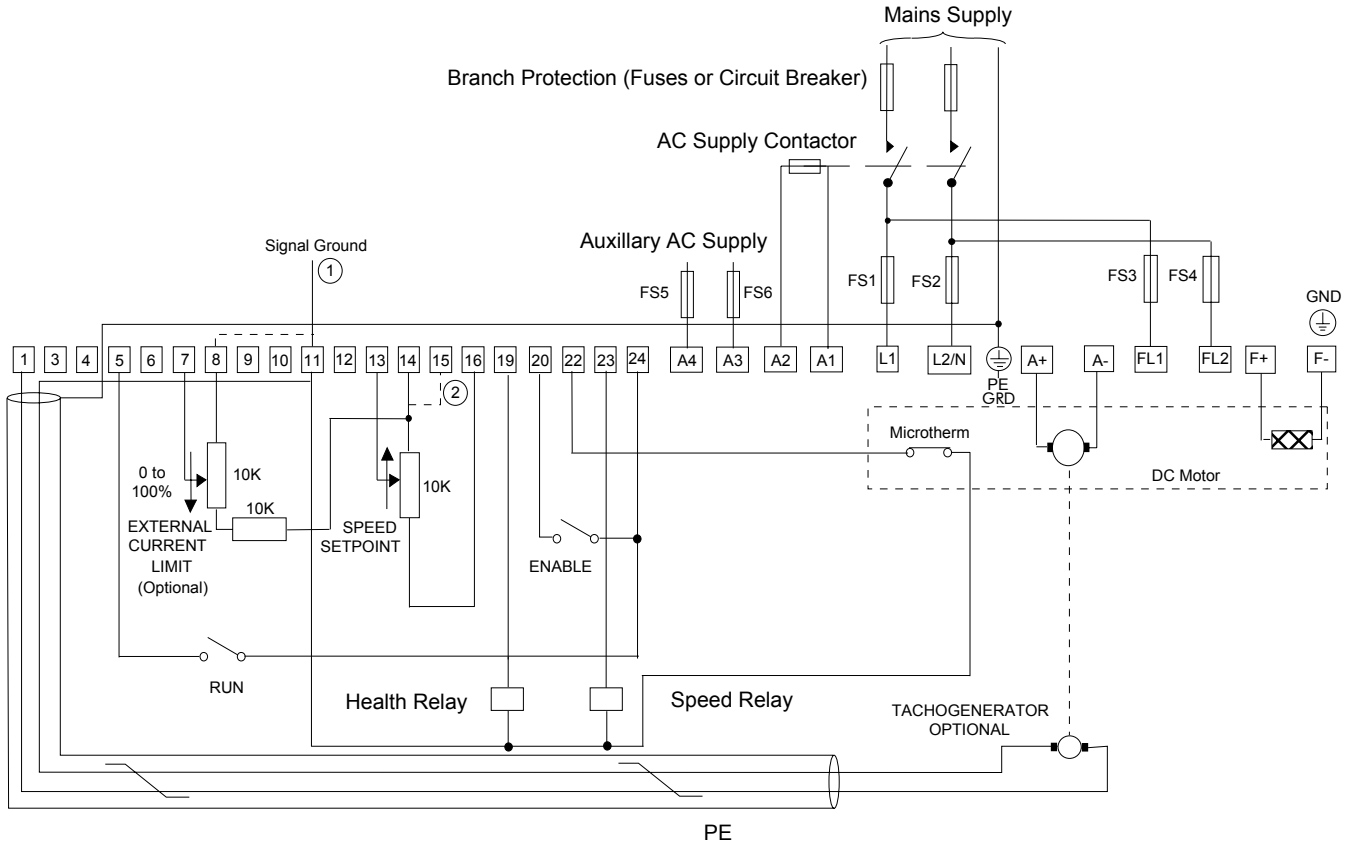

- ① It is recommended that the "0V/common" be connected to protective earth/ground for safety reasons. In a system comprising of more than one controller, the 0V/common" signals should be connected together and joined to protective earth/ground at **one** point only.
- ② Stall override link between terminals 14 and 15 required when using controller in current control.

EMC Connections With Filter

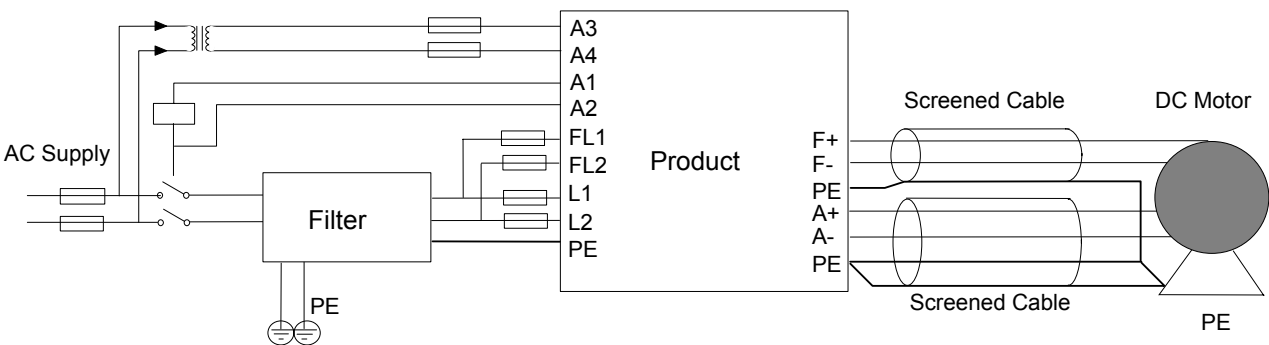

TERMINAL DESCRIPTIONS**Control Terminals**

TERMINAL	FUNCTION	DESCRIPTION	NOTES
T1	Tacho Feedback	Motor Mounted Tachogenerator Input. Proportional to Motor Speed.	+350 Vdc Max. Approx 220 kohm.
T2	Not Connected		
T3	Speed Meter Output	Analogue Output, 0 to $\pm 10V$ for 0 to $\pm 100\%$ Speed.	5mA output S/C protected
T4	DO NOT USE	Pending Change.	
T5	Run Input	Digital Input to Run Controller. +24V to Run. 0V to Stop.	
T6	Current Meter Output	Analogue Output, 0 to +7.5V = $\pm 150\%$ Calibrated Current SW1/5 Off = Bipolar SW1/5 On = Magnitude	5mA output S/C protected
T7	Torque/Current Limit Input	Analogue Input, 0 to +7.5V = 0 to 150% of Calibrated Current.	approx. 100 kohm
T8	0V Common	Analogue / Digital Signal Common	
T9	Setpoint Ramp Output	Analogue Output, 0 to $\pm 10V$ = 0 to $\pm 100\%$ Ramped Setpoint.	5mA output S/C protected
T10	Positive Trim Speed Setpoint Input	Analogue Input, 0 to $\pm 10V$ = 0 to $\pm 100\%$ Speed.	approx. 100 kohm
T11	0V Common	Analogue / Digital Signal Common.	
T12	Total Setpoint Sum Output	Analogue Output, 0 to $\pm 10V$ = 0 to $\pm 100\%$ Speed.	5mA output S/C protected
T13	Setpoint Ramp Input	Analogue Input, 0 to +10V = 0 to 100% Forward Speed. 0 to -10V = 0 to 100% Reverse Speed.	approx. 100 kohm
T14	+10V Reference Output	Analogue Output, +10V Reference for Speed/ Current Setpoints.	5mA output S/C protected
T15	Stall Override Input	Digital Input to Override Stall Detection +10V = Override.	approx. 100 kohm
T16	-10V Reference Output	Analogue Output, -10V Reference for Speed/ Current Setpoints.	5mA output S/C protected
T17	Negative Trim Speed Setpoint Input	Analogue Input, 0 to +10V = 0 to 100% Reverse Speed 0 to -10V = 0 to 100% Forward Speed.	approx. 100 kohm

TERMINAL	FUNCTION	DESCRIPTION	NOTES
T18	Current Demand Input / Output	Analogue Input or Output: SW1/8 'ON' = Current Demand Output. SW1/8 'OFF' = Current Demand Input. 0 to $\pm 7.5V$ = 0 to $\pm 150\%$ Current.	5mA output S/C protected approx. 100 kohm.
T19	Health Output	Digital Output, +24V = Healthy.	50mA Source Short Circuit Protected.
T20	Enable Input	Digital Input to Enable Controller. +10V to +24V to Enable. 0V to Disable.	100k approx.
T21	Inverted Setpoint Sum Output	Analogue Output, 0 to -10V = 0 to 100% Forward Speed.	5mA output S/C protected.
T22	Thermistor / Microtherm Input	Motor Thermistor or Microtherm Sensor <200 ohm to 0V = Normal. >1800 ohm to 0V = Overtemperature.	5k approx.
T23	Zero Speed Output /Zero Setpoint Output	Digital Output, +24V = Stopped/Zero Setpoint. 0V = Running/Non zero setpoint.	50mA Source Short Circuit Protected.
T24	+24V	+24V Supply Output.	20mA. For use on the drive only.



The +24v supply from the drive (terminal T24) is for use with the drive only. It should be used with the RUN circuit (terminal 5) to control the drives internal relay to switch the contactor and can be used with the ENABLE circuit (terminal T20).

DO NOT use the +24v supply to power any circuit or device external to the drive. This includes external relays, PLC's, and any other equipment.

Using the +24v external to the drive could result in drive malfunction or damage, damage to connected equipment, and could endanger personnel.

TERMINAL COMPARISON 540/1 TO 514C

Function	Terminal 540/1	Terminal 514C
Common	A1	T8
Armature Current (Direct)	A2	-
Setpoint Ramp Reset	A3	-
Setpoint Ramp Input	A4	T13
Setpoint Ramp Output	A5	T9
Setpoint Input 1 - Positive Trim Speed Setpoint I/P	A6	T10
Setpoint Input 2	A7	-
Inverted Sub-Total Output - Inverted Setpoint Sum O/P	A8	T21
Setpoint Input 3 (Inverted) - Negative Trim Speed Setpoint I/P	A9	T17
Total Setpoint	A10	T12
+10V Reference	A11	T14
-10V Reference	A12	T16
Common	B1	T11
Tachogenerator Input	B2	T1
Current Demand Isolate	B3	-
Current Demand Output	B4	T18
Auxiliary Current Demand Input	B5	T18
Select Auxiliary Current Input	B6	-
Auxiliary Current Limit Positive	B7	-
Main Current Limit	B8	T7
+10V Reference	B9	T14
Auxiliary Current Limit Negative	B10	-
Buffered Speed Output	B11	T3
Buffered Current Output	B12	T6

2-5 Pre-Installation Planning

Function	Terminal 540/1	Terminal 514C
Common	C1	T8/11
Thermistor	C2	T22
Auxiliary Enable	C3	-
+24V	C4	T24
Enable	C5	T20
Maintain	C6	-
Start / Run	C7	T5
Ready Output	C8	-
Zero Speed Output	C9	T23
Drive Operational / Health	C10	T19
+24V	C11	T24
Unused	C12	-
DO NOT USE Pending Change	-	T4
Stall Override	-	T15



Switches

Function	540/1		514C	
Speed Calibration	No		Yes	SW1/2
Tachogenerator or Armature Voltage	No		Yes	SW1/3
Zero Output Speed or Setpoint	No		Yes	SW1/4
Current Bipolar or Modulus	Yes	S1	Yes	S1/5
Ramp Isolate	Yes	S3	Yes	SW1/6
Standstill	Yes	S2	Yes	SWQ1/7
Current Demand Output or Current Demand Input	No		Yes	SW1/8
Contactor Dropout on Overcurrent	No		Yes	SW1/9
Standstill Comparator Source	No		Yes	SW1/10
Ramp Rate	Yes	S4	No	
Current Calibration	No		Yes	SW2/3/4

Auxiliary Supply Terminals

TERMINAL	FUNCTION	DESCRIPTION	NOTES
A1	AC Supply Contactor Coil.	AC Supply to AC Supply Contactor Switched Live.	540/1 Terminal D12
A2	AC Supply Contactor Coil.	AC Supply to AC Supply Contactor Neutral.	540/1 Terminal D11
A3	Auxiliary AC Supply Neutral.	Auxiliary Supply for Power Supplies and Contactor.	540/1 Terminal D10
A4	Auxiliary AC Supply Live.	Auxiliary Supply for Power Supplies and Contactor.	540/1 Terminal D9

Power Terminals

TERMINAL	FUNCTION	DESCRIPTION	NOTES
L1	AC Input Line 1	Mains Supply Line 1 Input	L1
L2/N	AC Input Line 2/ Neutral	Mains Supply Line 2 Input or Neutral	L2/N
A+	Armature Positive	Motor Armature Positive Output.	A+
A-	Armature Negative	Motor Armature Negative Output.	A-
	Ground		

Field Terminals

TERMINAL	FUNCTION	DESCRIPTION	NOTES
F-	Field Negative	Motor Field Negative DC Output	540/1 Terminal D7
F+	Field Positive	Motor Field Positive DC Output	540/1 Terminal D5
FL2	Field Rectifier Supply	Mains Supply Input Field Rectifier	540/1 Terminal D3
FL1	Field Rectifier Supply	Mains Supply Input Field Rectifier	540/1 Terminal D1

BLOCK DIAGRAM

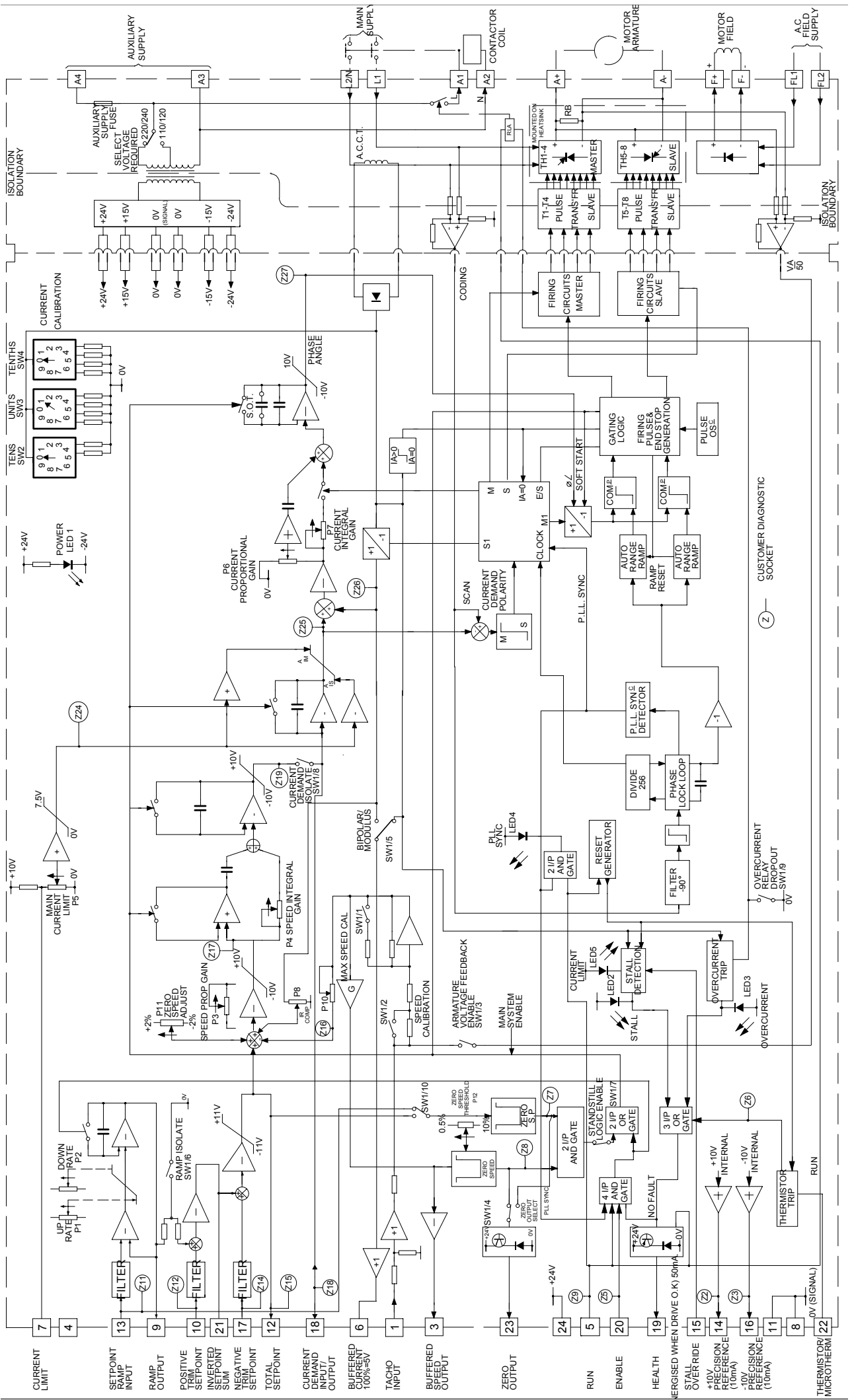

FUNCTIONAL DIFFERENCES 514C - 540

Feature	540 Series	514C
Overload	Inverse Time reduced Current Limit.	Stall Detection & Timed Inhibit.
Overload	200% for 10 seconds.	150% for 60 seconds.
Overcurrent	-	300% Instantaneous Trip.
Ramp	0.1 to 2 secs or 1 to 20 secs.	1 to 40 seconds.
Ramp Reset	Internal & External.	Internal.
Speed Setpoint Inputs	Ramp, Input No 1, Input No 2 and Inverted Input No 3.	Ramp, Positive Trim & Negative Trim Input.
Auxiliary Current Clamp Positive	Auxiliary Current Limit of Positive Demand.	Not Provided.
Auxiliary Current Clamp Negative	Auxiliary Current Limit of Negative Demand.	Not Provided.
Current Demand Output	Speed Loop Current Demand Output.	Current Demand O/P or Ext. Current Demand I/P.
Current Demand Isolate	Isolates Speed Loop Current Demand from Current Path.	DIL Switch Selectable.
External Current Demand I/P	Additional Current Demand.	Current Demand O/P or Ext. Current Demand I/P.
Current Demand Connect	Enable Input of External Current Demand.	Not Provided.
Armature Current Output	External IR Compensation via Armature Current Output.	Internally provided.
Auxiliary Enable	External Trip / Enable.	Not Provided.
Ready	Drive Ready Output.	Not Provided.
Stop Input	Maintain for Momentary Start.	Not Provided.
Field Fail	Field Current detector.	Not Provided.
Stack Fuses	Semiconductor Fusing.	Not Provided.
Relays	Output Sink unprotected.	Output Source Short Circuit Protected.
EMC		Complies with EMC Directive.
LVD		Complies with Low Voltage Directive.



WARNING

THE 514C IS NOT A DIRECT REPLACEMENT FOR THE 540/1. IT IS FUNCTIONALLY EQUIVALENT.

NOTE WHEN A 514C IS USED TO REPLACE A 540 WITH THE HEALTH AND/OR ZERO SPEED RELAYS UTILISED, THE RELAYS MUST BE RECONNECTED BETWEEN OUTPUT AND SIGNAL COMMON NOT +24V.

Chapter 3 Installation Procedure

INSTALLATION PRECAUTIONS

Before connecting AC supplies to this equipment.

- 1) Ensure good airflow over the heatsink. Maintain clearance of 75mm above and below controller. For safety maintain a clearance of 20mm at the sides of the controller.
- 2) Operating temperature range does not exceed 0 to +40°C.
- 3) Controller is used in a Pollution Degree 2 environment.
- 4) Avoid vibration.

MECHANICAL INSTALLATION

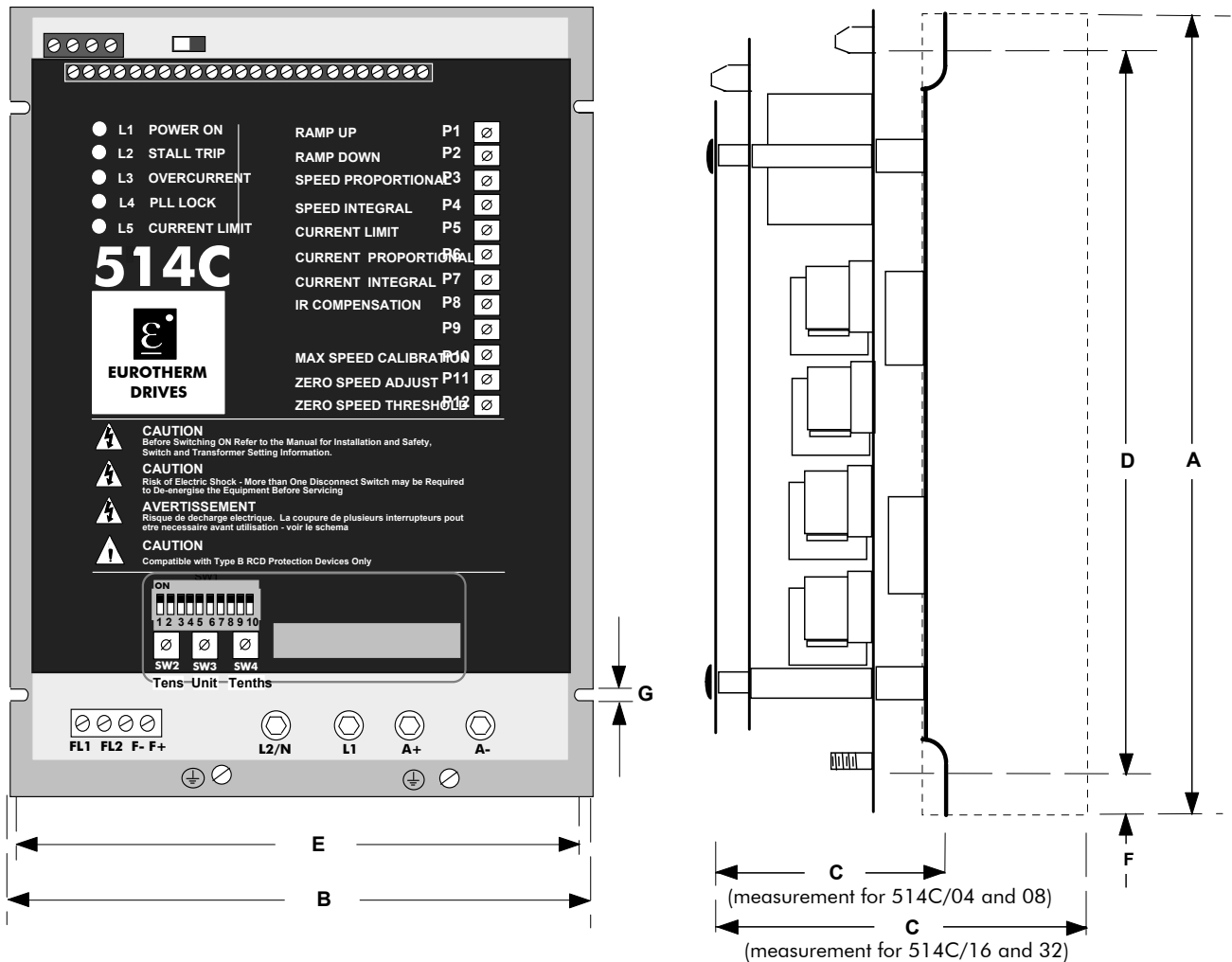

PRODUCT	OVERALL DIMENSIONS			FIXING CENTRES		SIZE	SLOT DETAIL	
	A	B	C	D	E		F	G
514C/04	240mm	160mm	90mm	210mm	148mm	M6	15mm	7mm
514C/08	240mm	160mm	90mm	210mm	148mm	M6	15mm	7mm
514C/16	240mm	160mm	130mm	210mm	148mm	M6	15mm	7mm
514C/32	240mm	160mm	130mm	210mm	148mm	M6	15mm	7mm

3-2 Setting up & Commissioning

Filter

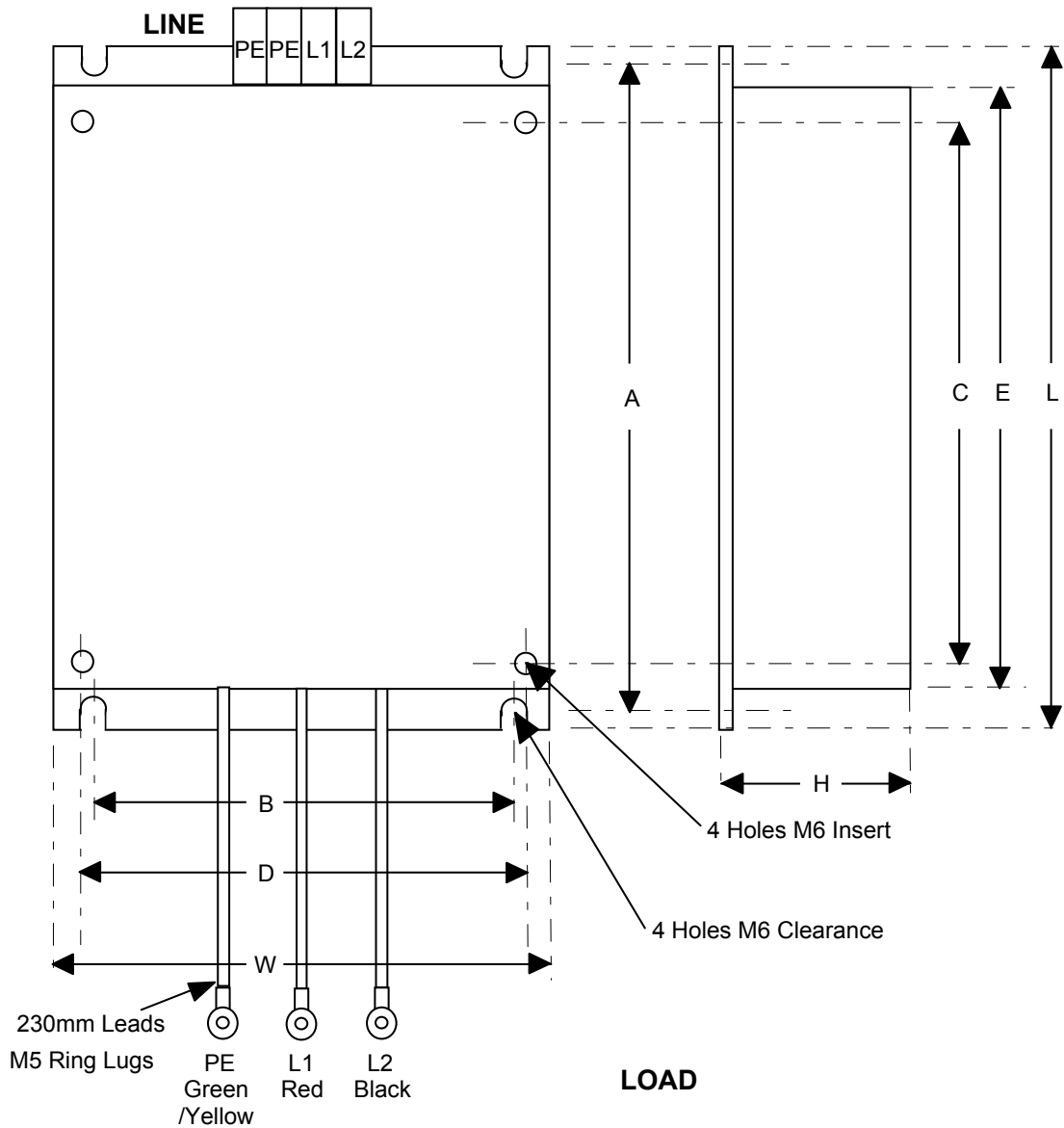

Product	Filter	Watt Loss	Overall Dimensions				Fixing Centres		Product Fixing		Terminal
			L	W	H	E	A	B	C	D	
514C/04	CO389113	18W	264	165	45	240	253	120	210	148	4mm ²
514C/08	CO389113	18W	264	165	45	240	253	120	210	148	4mm ²
514C/16	CO389113	18W	264	165	45	240	253	120	210	148	4mm ²
514C/32	CO389114	36W	264	165	70	240	253	120	210	148	6mm ²

Installation Information**MOTOR**

- 1) Ensure motor is mechanically secure and mounted according to manufacturers specifications and practice.
- 2) Inspect brush gear, ensure commutator is in good condition and brushes are free to move in brush box and in good condition.
- 3) Check obstructions in motor vents to maintain cooling air path.
- 4) Ensure motor armature choke (if specified) is correctly wired.
- 5) Ensure motor is free to rotate and that pulleys and couplings are correctly aligned.
- 6) Ensure transit damage has not occurred to motor windings or connections. Disconnect the controller before carrying out electrical measurement e.g. insulation resistance.

ELECTRICAL INSTALLATION**RECOMMENDATIONS**

- 1) Although the controller is designed to provide double or reinforced insulation between the user and bare live parts, it is recommended that the “0v/Signal Ground” is earthed. Where a number of controllers are used in a system the “0v/Signal Ground” terminals should be grounded together and earthed at one point.
- 2) The controller is designed for armature current form factor of 1.5 or less. It is recommended that a armature choke be fitted where a form factor of less than 1.5 current cannot be guaranteed.
- 3) Due to the earth leakage currents the controller and filter should be permanently earthed. This can be achieved by either connecting two earthing conductors of the required value, see table 3.1, or connecting one earthing conductor of at least 10mm².
- 4) Unused Analogue Inputs should be “grounded” (i.e., connected to 0V/Signal Ground) to eliminate interference.

WIRING

- 1) Control cabling 0.75sq.mm minimum.
Auxiliary supply cable 1.5mm²
Field cable 1.5mm²
- 2) Power cable to be minimum 600VAC rated at 1.5 x armature current.
- 3) High speed semi-conductor fuses of the correct rating are recommended for incoming supply protection. The 514C is not internally fused.
- 4) Ensure a protective earth connection is made compatible with the rating.
- 5) Isolated control wiring should not be run close to the power cabling. If screened cables are used (recommended on setpoints and tachogenerators) connect screens to earth only at controller end.
- 6) SSD Drives can supply fuse assemblies which can be bulkhead mounted and also act as convenient supply isolators.

3-4 Setting up & Commissioning

	Function	Rating	Cable Size	Fuse Isolator Kit	Fuse Rating	ED Part No.
514C/04	Supply	6A	1.5mm ² /16AWG	LA057605U012	12A fuse	CH390123
	Motor	4A	1.5mm ² /16AWG		(10A U.S.)	
	Ground		1.5mm ² /16AWG			
514C/08	Supply	12A	2.5mm ² /14AWG	LA057605U016	16A fuse	CH390163
	Motor	8A	2.5mm ² /14AWG		(15A U.S.)	
	Ground		2.5mm ² /14AWG			
514C/16	Supply	24A	6mm ² /10AWG	LA057605U032	32A fuse	CH390323
	Motor	16A	6mm ² /10AWG		(30A U.S.)	
	Ground		6mm ² /10AWG			
514C/32	Supply	48A	16mm ² /6AWG	LA057605U050	50A fuse	CH390054
	Motor	32A	16mm ² /6AWG		(60A U.S.)	
	Ground		16mm ² /6AWG			
ALL	Field	3A	1.5mm ² /16AWG	LA054664	10A	CH230014

TABLE 3.1 Recommended Cable Sizes.

Note:- The cable sizes shown are based on a Form Factor of 1.5 and an overload allowance of 110% (giving a multiplier of 1.65), they are selected for the notional rating of each controller. Smaller cable may be used if the controller is calibrated at a lower current level.

Terminal Tightening Torques

Control	0.45 Nm	0.33 lbf-ft	4.0 lbf-in
Auxiliary Supply & Field	0.5 Nm	0.375 lbf-ft	4.5 lbf-in
Power	2.7 Nm	2 lbf-ft	24 lbf-in
Earth (Grounding)	7.1 Nm	5.25 lbf-ft	63 lbf-in

REQUIREMENTS FOR UL COMPLIANCE

UL and c-UL Listing applicable to 514C/04, 514C/08 and 514C/16 Series only.

Motor Overload Protection

An external motor overload protective device must be provided by the installer.

This device can be a thermal sensor located within the motor winding monitored by the microtherm input but this combination cannot be evaluated by Underwriters Laboratories Inc., hence it is the responsibility of the installer/local inspector determine whether the combination is in compliance with the National Electrical Code NEC/NFPA-70, or local code requirements.

Field Grounding Terminals

The International Grounding Symbol (⊕) (IEC Publication 417, Symbol 5019) is used to designate the field grounding terminals.

The field grounding terminal is a single screw, sized No. 10 (M5). UL Listed (ZMVV) pressure wire connectors rated No. 14 AWG (copper) must be used for Models 514C/04, 514C/08. UL Listed (SMVV) pressure wire connectors rated No. 10 AWG (copper) must be used for Models 514C/16.

Short Circuit Protection

UL Listed fuses, Class RK5, rated 250V ac or 600V ac (as appropriate, depending on the rated input voltage of the drive), 50A maximum, must be installed upstream of the drive.

Short Circuit Rating

Models rated more than 1Hp. Suitable for use on a circuit capable of delivering not more than 5000 RMS Symmetrical Amperes, 480V maximum.

Operating Ambient Temperature

The maximum operating ambient temperature rating is 40°C.

Field Wiring Temperature Rating

Use 60°C or 60/75°C copper conductors only.

Field Wiring Terminal Markings

For terminal connections, refer to page 2-6, “Auxiliary Supply terminals”, “Power Terminals”, “Field Terminals” and page 2-2, “Control Terminals”.

Power Field Wiring Terminals

The pressure terminal connectors provided on models 514C/04, 514C/08 accept a maximum copper conductor size of No. 14 AWG. The pressure terminal connectors provided on models 514C/16 accept a maximum copper conductor size of No. 10 AWG.

Terminal Tightening torque

Refer to page 3-4 “Terminal Tightening Torques” for the tightening torques for power, control and grounding terminals.

Chapter 4 Setting-Up & Commissioning

OPTION SWITCHES

Speed Feedback

SW1/1	SW1/2	FEEDBACK VOLTAGE	
OFF	ON	10 - 25V	USE P10 TO TRIM
ON	ON	25 - 75V	MAXIMUM SPEED
OFF	OFF	75 - 125V	TO REQUIRED
ON	OFF	125 - 325V	VALUE

TABLE 4.1 Full speed tachogenerator/armature feedback voltage.

Example:

- (a) Customer wishes to run motor at 1500rpm with a 60V/1000rpm tachogenerator.
Feedback voltage = 90V.
From Table 4.1 set SW1 OFF SW2 OFF adjust P10 to give desired speed.
- (b) Customer wishes to run motor at 2000rpm with 320V armature.
Feedback voltage = 320V
From Table 4.1 set SW1 ON SW2 OFF adjust P10 to give desired speed.

Note:- It is necessary to set these switches for both tachogenerator and armature voltage feedback.

General Purpose Switches

SW1/3	Speed Feedback	(OFF)	Tachogenerator Feedback for Speed Control.
		(ON)	Armature Voltage Feedback for Speed Control.
SW1/4	Zero Output	(OFF)	Zero Speed Output.
		(ON)	Zero Setpoint Output.
SW1/5	Current Meter	(OFF)	Bipolar Output.
		(ON)	Modulus Output.
SW1/6	Ramp Isolate	(OFF)	Ramp Connected.
		(ON)	Ramp Isolated.
SW1/7	Standstill Logic	(OFF)	Disabled.
		(ON)	Enabled.
SW1/8	Current Demand	(OFF)	T18 = Current Demand Input.
		(ON)	T18 = Current Demand Output.
SW1/9	Contactor Drop Out on Over-Current	(OFF)	Contactor Drops Out on Over Current trip
		(ON)	Contactor does not Drop Out on Over Current trip
SW1/10	Setpoint Comparator.	(OFF)	Total Setpoint.
		(ON)	Ramped Setpoint Input.

Default switch settings are

SW1/1 = Off SW1/2 = On SW1/3 = On SW1/4 = Off SW1/5 = Off SW1/6 = Off
SW1/7 = Off SW1/8 = On SW1/9 = Off SW1/10 = Off

Current Calibration

Current Calibration is achieved using the BCD switches SW2, 3 and 4 where SW2 represents the 'Tens'; SW3 represents the 'Units' and SW4 represents the 'Tenths'. Thus a 16.5 amp calibration is achieved by setting switch SW2 to 1, SW3 to 6, and SW4 to 5.

Please note that incorrect adjustment of these switches will cause excessive current to flow which may cause damage to the motor and the controller. The absolute maximum setting which can be set is 39.9 amps, this exceeds the Maximum Controller rating in all builds.

POTENTIOMETERS

P1	Ramp Up Rate	Rotate Clockwise for Faster Acceleration to Set Speed. (Linear :- 1 to 40 seconds)	Default Setting: Midway	540/1 P1
P2	Ramp Down Rate	Rotate Clockwise for Faster Deceleration to Set Speed. (Linear :- 1 to 40 seconds)	Midway	540/1 P2
P3	Speed Loop Proportional	Optimises Speed Loop Stability by increasing gain.	Midway	540/1 P5
P4	Speed Loop Integral	Optimises Speed Loop Stability by increasing integral time constant.	Midway	540/1 P6
P5	I Limit	Rotate Clockwise to increase Maximum Output Current. With no additional connection to Torque / Current Limit Terminal T7, the Upper Limit is 110%. To achieve the 150% maximum connect T7 to +7.5V.	90% Clockwise	540/1 P7
P6	Current Loop Proportional	Optimises Current Loop Stability by increasing gain.	Midway	540/1 P8
P7	Current Loop Integral	Optimises Current Loop Stability by increasing integral time constant.	Anti-Clockwise	540/1 P9
P8	IR Compensation	Optimises speed regulation against load change when using Armature Voltage Feedback. Rotate Clockwise to increase compensation and reduce regulation. (Excessive adjustment may lead to instability)	Anti-Clockwise	
P9	DO NOT USE	Pending Change.		
P10	Maximum Speed	Controls Maximum Motor Speed. Rotate clockwise to increase maximum speed.	Midway	540/1 P10
P11	Zero Speed Offset	Adjusts Zero for Zero Speed Setpoint.	Approximately Midway	540/1 P3
P12	Zero Speed Sense Threshold	Adjusts the Zero Speed sense Level for the Zero Speed relay and Standstill Logic if selected.	Anti-Clockwise	540/1 P4

TABLE 4.3 Customer Adjustments.

BASIC SETTING-UP PROCEDURE

Preliminary Precautions

BEFORE ATTEMPTING TO CONNECT POWER:-

CONTROLLER

Check:-

1. The Auxiliary Supply Voltage is correctly selected on the Power Board.
2. The Main Power Supply Voltage is within the operating range of the controller.
3. The Armature Voltage and current ratings are compatible with controller supplied.
4. The Field Voltage and current ratings are suitable.
5. All external wiring circuits are correct, i.e:-
 - a) Auxiliary connections
 - b) Power connections
 - c) Control connections
 - d) Motor connections

NOTE: Completely disconnect the controller before point to point checking with a buzzer or when checking insulation with a megger.

6. For damage to equipment.
7. For loose ends, clippings, drilling swarf etc., lodged in the drive or ancillary equipment.

MOTOR

1. Inspect the motor, in particular the commutator for any extraneous matter. If an air supply is available, it is recommended to blow over the commutator.

Check the brushes are properly seated and that the brush spring tension is adequate.

If possible check that the motor (and vent fan if fitted) can be turned freely by hand.

Preparation

MACHINE

Check:-

1. That rotation of the motor in either direction will not cause damage.
2. That nobody else is working on another part of the equipment that will be affected by powering up.
3. That other equipment will not be adversely affected by powering up.

CONTROLLER

1. Prevent application of the main power supply by removal of the supply fuses.
2. Disconnect the load from the motor shaft if possible.
3. If there is any doubt as to the integrity of a particular installation, insert a high wattage resistor (i.e. fire bar elements) in series with the motor armature.
4. If it is possible to rotate the motor, and tachogenerator feedback is in use, check that forward rotation results in positive tacho feedback, i.e. terminal 1 is positive with respect to terminal 8 or 11.

5. Check switch selection

SW1/1)	Speed Range (see table 4.1)
SW1/2)	
SW1/3	Tachogenerator / VA (see switch options on page 4.1)
SW1/4	Zero Speed / Zero Setpoint (see switch options on page 4.1)
SW1/5	Current Meter Output
SW1/6	Use of Setpoint Ramp
SW1/7	Standstill Logic
SW1/8	Current Demand strategy
SW1/9	Contactor Drop Out on Over-Current
SW1/10	Zero Setpoint source
6. SW2, 3 and 4 Check Current Calibration.
7. Check all pots are set thus:-
 Potentiometers P4, P5, P7, P8, P10, P12 fully anticlockwise.
 (Potentiometer P5 will be set to 90% clockwise when the drive is unpacked).
 Potentiometers P1, P2 , P3 and P7 mid position.
 Potentiometer P11 should be left at the factory set position (approximately midway) until zero speed adjustment is required.
8. Check auxiliary supply transformer tap is compatible with the auxiliary supply voltage.
9. Check external run contacts are open.
10. Check external set points are all zero.

Power-Up

Although fairly general, the following assumes the system to be a simple speed control drive and motor.

1. When all the preceding steps are completed the auxiliary power supply can be connected to terminals A3 and A4, (but do not connect the L1 and L2 main power supply at this stage). Immediately check that the correct voltage appears between A3 and A4.
2. Now check:-
 - i) The drive condition indicators - these are 5 LED lamps at the top left corner of the product. The "Power-On" should be on.
 - ii) Check that the +24v (nominal) supply at terminal T24 (with respect to T8 or T11) is between 22 and 30 volts dc.
 - iii) If a Diagnostic Test Unit (5570) is available, check the ± 15 v supplies on switch positions 1 and 4.
 - iv) Check the + 10v supply rail:
 Switch to diagnostic test point 2 or measure the voltage between terminals T14 (+10v) and T8 (0v).
 - v) Check the -10v supply rail:
 Switch to diagnostic test point 3 or measure the voltage between terminals T16 (-10v) and T8 (0v).
 Note:- If the supply voltages are incorrect check setting of Auxiliary Supply Selector Switch.
3. If a Diagnostic Test Unit is available, check that all other test point readings are as shown in Diagnostic Chart 3.

4-5 Setting up & Commissioning

4. Check that a speed demand signal is available. This will normally appear as an input to the Setpoint Ramp on terminal T13 (diagnostic test point 11).
Additional setpoint inputs may also appear at:
Positive trim, terminal T10 (diagnostic 12)
Negative trim, terminal T17 (diagnostic 13)
Note: The sum of the setpoint voltages appears at terminal T12 (diagnostic 15) as the Total Setpoint voltage.
5. Check the polarity of the tachogenerator signal, if used, by rotating the motor shaft manually in the “forward” direction (i.e., the direction which should correspond to a positive setpoint at T13):
The voltage at terminal T1 (or T3) should go positive.
If armature voltage feedback is being used the polarity of the feedback signal is inherently correct. It is however important to ensure that the speed scaling has been set correctly even in armature voltage feedback mode.
6. Apply the ‘RUN’ signal to T5 and maintain.
The main supply contactor (L1 and L2) should close.
Remove the ‘RUN’ signal.
The main supply contactor should open. If not disconnect all power supplies and check the run circuit and contactor wiring.
Note: The main contactor should NEVER be operated by any means other than the drive internal contactor control circuit as shown in the basic wiring diagram.



DO NOT PROCEED FURTHER UNLESS THE RUN CIRCUIT AND CONTACTOR OPERATE CORRECTLY.

7. Turn off all power supplies to the equipment and when the whole system is totally isolated and safe, re-connect the Main L1 and L2 supply.
8. Turn on Auxiliary single phase supply.
9. Turn on Main L1 and L2 supply.
10. Turn the Speed Setpoints to zero so that the Total Setpoint voltage is zero (terminal T12, Diagnostic 15).
11. Check that the Main Current Limit preset (P5) is turned to zero (fully anti-clockwise).
12. Initiate “Drive Run” and immediately check that the correct field voltage appears between terminals F+ and F-. Note that this will be high voltage dc, so proceed with extreme caution. Do not continue if this is not correct, but switch off all supplies and check Field Voltage is compatible with supply.
Check that the motor ventilation fan, if fitted, is rotating in the correct direction. Check the direction visually as the fan starts since a centrifugal fan may produce considerable air flow even when rotating in the wrong direction.
13. Check that LED 4 PLL Lock is illuminated. Refer to the Diagnostic section for explanation of the LED functions.
14. Check that the Standstill Logic is switched OFF (SW1/7).

NOTE:-

- a) During the following stages (15 and 16) be ready to stop the drive immediately should the motor overspeed.

b) Before altering any connections make sure that all Auxiliary and Main power supplies are totally isolated from the drive and equipment and that the motor is stationary.

15. Adjust the Speed Setpoint so that the Total Setpoint voltage is about 0.5 Volts (terminal T12, Diagnostic 15).

Note:- If the Ramped Speed Setpoint is being used with default ramp settings the total setpoint will take time to change.

Slowly increase the Main Current Limit setting (P5) up to about 20% FLC (i.e., not more than 1 volt at Diagnostic test position 24). Since the Total Setpoint is set to 0.5v the motor speed should increase to only 5% of full speed. If this speed is exceeded, then the tacho polarity is wrong or tacho scaling is incorrect, quickly turn the Main Current Limited (P5) to zero (anti-clockwise).

Initiate Stop and de-energise the controller.

If overspeeding occurred while using a tachogenerator for speed feedback correct wiring as follows:

Problem	Action
a) Direction correct but overspeeding:	Reverse tacho polarity only
b) Direction incorrect and overspeeding:	Reverse field polarity only

When armature voltage feedback is used for speed feedback it is direction insensitive and overspeeding due to incorrect feedback cannot occur, excess speed is probably due to incorrect feedback scaling, check setting of switches SW1 and SW2.

If the motor runs under control but in the wrong direction correct as follows either:-

a) Armature Control	Reverse Field polarity
b) Tachogenerator Control	Reverse Field and Tachogenerator Polarity

16. When the Main Current Limited (P5) set to about 20% FLC slowly increase the Total Setpoint voltage to +1 volt (terminal T12, Diagnostic 15). The motor should now run at about 10% Full Speed.

Note: When correctly connected and operating normally at constant speed the Speed Feedback voltage (Diagnostic 16) will be equal to the Total Setpoint voltage (Diagnostic 15) but is of the opposite polarity. Under these conditions the Speed Error voltage (Diagnostic 17) will be zero. If this condition cannot be achieved, the system is probably in current limit (this is likely at this stage if the output load is coupled to the motor shaft). Increase the setting of the Main Current Limit (P5) slowly until the motor accelerates to set speed and the Speed Error signal falls to zero.

17. Adjust the Total Setpoint voltage to about -1v and check that the motor runs in control in the reverse direction.
18. Set the Speed Setpoint to zero and adjust the Speed Zero preset potentiometer (P11) for minimum shaft creep. (Alternatively the Speed Zero potentiometer may be used to adjust the balance of maximum speed in forward and reverse directions).
19. Gradually increase the Speed Setpoint to maximum and check that the shaft speed is nominally correct. Adjust P10 to desired speed. Check that the armature voltage does not exceed rated value.

Note: If the load is connected to the motor it may be necessary to increase the Main Current Limit control (P5) setting to achieve full speed.

20. Reverse the Speed Setpoint and check the maximum reverse speed.
21. Set the Main Current Limit (P5) to maximum. If in doubt monitor Diagnostic 24 and set to 5v i.e., 100% current.

RUNNING PERFORMANCE ADJUSTMENTS

GENERAL

If the controller is operating in tachogenerator mode the IR compensation potentiometer (P8) must be anti-clockwise.

The Proportional and Integral potentiometers (P3, P4, P6 P7) as preset by SSD Drives will provide stable and responsive performance under most load conditions. Thus if instability is observed it is important to first check the load and coupling:

If there is a cyclic variation of the armature current check the mechanical couplings to the load - this is a common cause of apparent instability in either the speed or motor current. If speed instability is present check whether the repetition rate of the instability is related to the mechanical revolution of the load - if it is then the instability frequency will vary with speed. This form of instability may be reduced by adjustment of the drive presets, but total elimination of the problem may require improvement of the load characteristics.

Instability due to incorrect setting of the drive control parameters can occur and is recognisable because its frequency will be independent of the motor speed. If this form of instability is present, or if the application demands that the drive is trimmed for optimum response, then the stability controls may be adjusted as follows. Note that while the speed stability and response may be improved without the use of a Diagnostic Unit or Oscilloscope it is difficult to optimise the current response without such instrumentation. Consequently, the following procedure assumes that both instruments are available.

Current Loop Adjustment (P6 and P7)

1. With all power supplies disconnected, disconnect the field wires from terminals F+ and F- labelling each wire clearly so that it can later be reconnected with the correct polarity. Connect the Stall Override terminal T15 to +10v.

NOTE:

- (i) It is now possible to operate the motor in a stalled condition. Great care must be taken not to damage the motor by overheating. If the motor is fitted with a force ventilation fan, arrange that it is connected and running during the test. In any case **DO NOT** remain in the stalled condition for long periods.
 - (ii) Although the field supply is disconnected the motor may still produce some torque due to residual or compound field flux. It is essential therefore, to mechanically lock the motor shaft, or apply sufficient load to prevent rotation during the following procedure.
2. The optimum setting of the Current Proportional and Integral presets (P6 and P7) depends, to some extent, on the setting of the Main Current Limit (P5). Thus P5 should be correctly adjusted to suit the load, before adjustment of P6 and P7 is attempted.
3. When the Main Current Limit control is correctly set, proceed as follows:
Ensure that a step change can be applied to the speed setpoint path.
Connect the Diagnostic Unit to the Control printed circuit board. Connect the Oscilloscope to the output sockets on the Diagnostic Unit and switch to Diagnostic 26. This provides access to a safe, isolated signal representing the armature current waveform where $\pm 1.1\text{v} = \pm 100\%$ full load current.
4. Reconnect the supplies, switch on and RUN. Observe the armature current waveform while changing the polarity of the Current Demand signal (by varying the Speed Setpoint). With each

change of Current Demand polarity the current should increase rapidly, but without overshoot and then remain steady. If necessary adjust P6 and P7 slowly to obtain a Critically Damped performance, i.e., the fastest response possible without overshoot, as shown in Figure 3.

Figures 1 and 2 show typical armature current waveforms where P6 and P7 are incorrectly set and indicate the adjustment required to improve the drive performance to conform with that of Figure 3.

In general, clockwise rotation of the presets will improve the speed of response, but rotating the controls too far will tend to introduce overshoot.

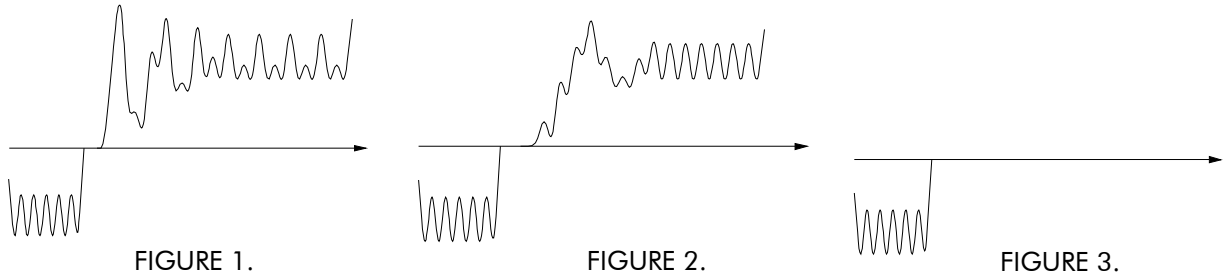

FIGURE 1.
 ARMATURE CURRENT WAVEFORM:
 Current Loop controls incorrectly set. Integral Time Constant too short - increase Current Loop Integral Time Constant by rotating P7 anticlockwise.

FIGURE 2.
 ARMATURE CURRENT WAVEFORM:
 Current Loop controls incorrectly set. Proportional Gain too low - increase Current Loop Proportional Gain by rotating P6 clockwise.

FIGURE 3.
 ARMATURE CURRENT WAVEFORM:
 Current Loop Response (P6 and P7) correctly adjusted.

- When the Current Loop response adjustment is completed, switch off the drive and disconnect all supplies.

Reconnect the field wires to terminals F+ and F- ensuring that they are replaced in their original positions i.e., with correct polarity. Remove any mechanical devices previously used to lock the motor shaft.

Speed Loop Adjustment (P3 and P4)

- If the Speed Setpoint is applied via the setpoint ramp turn P1 and P2 fully clockwise minimum ramp time. Set the Speed Setpoint to zero. Switch the Diagnostic Unit to position 16 so that the Oscilloscope displays the scaled Tacho Feedback signal ($\pm 2.7v = \pm 100\%$).

- Reconnect the supplies switch on and initiate "Run". Apply a small set change (about 20%) to the Speed Setpoint input and observe the speed response. If necessary adjust the Speed Proportional and Speed Integral presets (P3 and P4) gradually to obtain a Critically Damped performance, i.e., the fastest response possible without overshoot, as shown in Figure 4, Curve (c). In general, clockwise rotation of the presets will improve the rate of response, but advancing the controls too far will tend to introduce overshoot. The optimum setting of P3 and P4 will be a compromise between the two extremes shown in Curves (a) and (b), Figure 4.

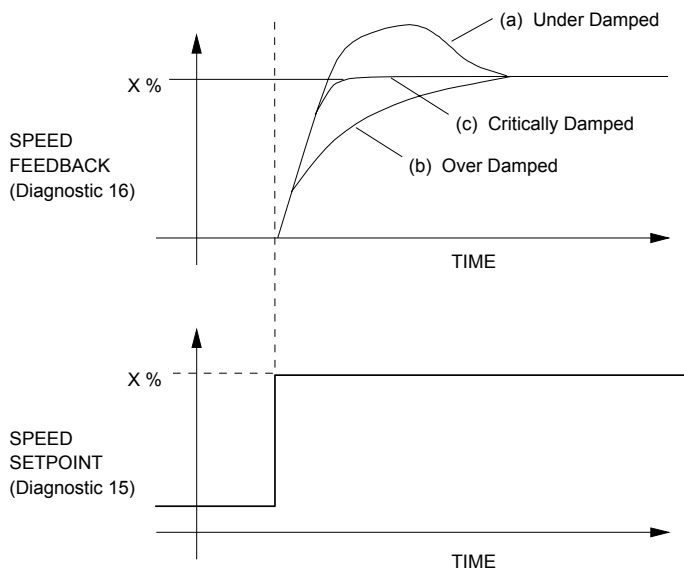
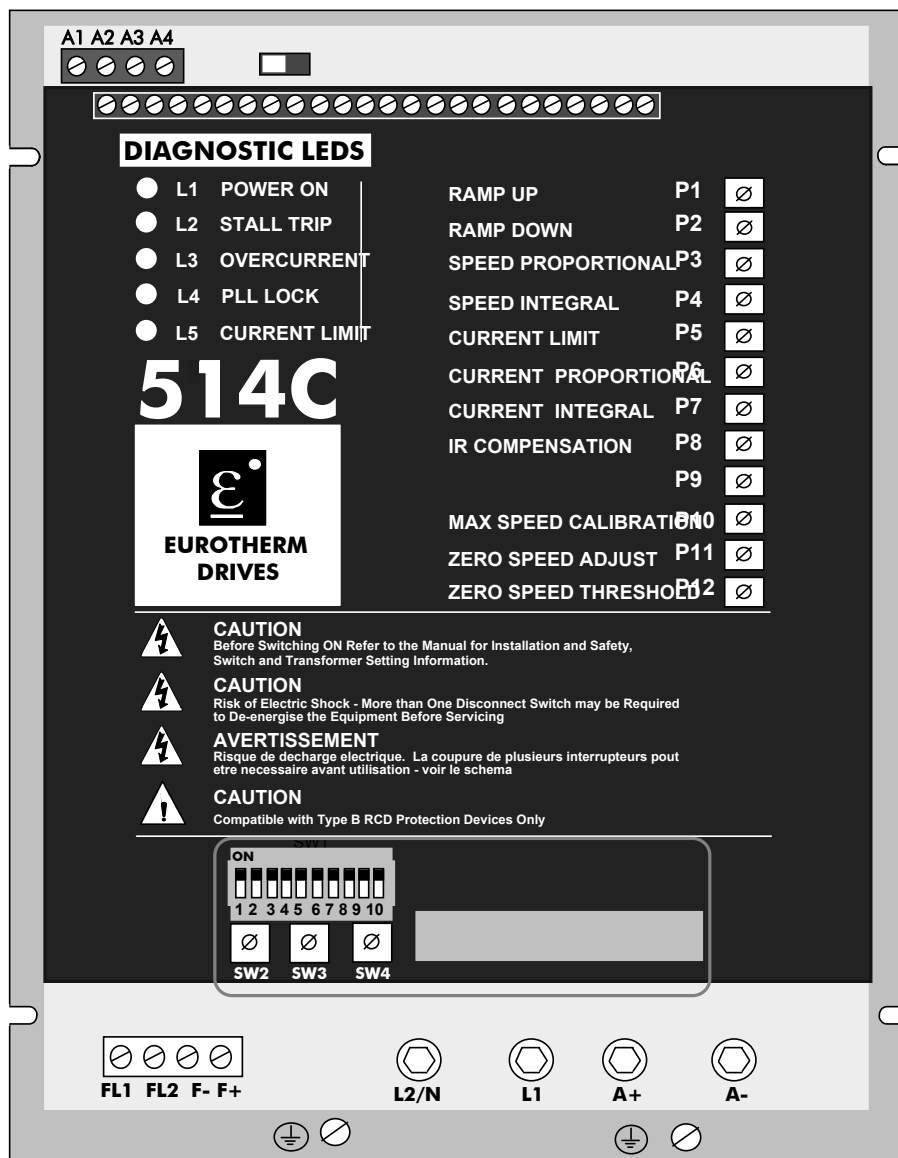

FIGURE 4. TYPICAL SPEED RESPONSE CURVES

Chapter 5 Diagnostics and Fault Finding

DIAGNOSTIC LEADS

LED1	POWER ON	Illuminated when the Auxiliary Supply is energised.
LED2	STALL TRIP	Illuminated when the Controller has detected a Stall or Current Limit Condition for more than 60 seconds.
LED3	OVERCURRENT	Illuminated when the Armature Current exceeds approximately 3½ times Calibrated Current.
LED4	PLL LOCK	Illuminated when the Main AC Supply is energised and the Electronic Phase Lock Loop is Synchronised.
LED5	CURRENT LIMIT	Illuminated when the Controller is in Current Limit and Speed Control is lost, i.e. a stall condition, after 60 seconds the controller will trip.



DRIVE TRIPS

When a fault occurs the drive will trip and display the cause of the trip on the indicator LEDs or on the diagnostic (test point 6) for the Thermistor/Microtherm Trip.

The Stall Trip (LED2 on) and the Thermistor/Microtherm Trip are reset by re-applying the run signal to Terminal 5. The drive will then re-start. (It is necessary to remove then re-apply the run signal.)

An Overcurrent (LED3 on) is not reset by the Run signal re-application as this trip can indicate that a major fault has occurred. The overcurrent trip is reset by removing then re-applying the auxiliary supply. Remove the Run signal before removing the auxiliary supply.

Resetting the Stall Trip does not reset the drive's internal timer that caused the trip. If the drive is operated in current limit (LED5 illuminated) immediately after a Stall Trip the trip could re-occur. This protects the drive and the motor from continuous overload operation. However, it is possible to prevent the stall trip by using the Stall Override (Terminal 15)

DIAGNOSTIC TEST POINT DESCRIPTIONS

Test Node	Description	Condition	Voltage
1	Internal +15V Supply	Auxiliary Supply On	+15V ±0.15V
2	External +10V Supply	Auxiliary Supply On	+10V ±0.025V
3	External -10V Supply	Auxiliary Supply On	-10V ±0.025V
4	Internal -15V Supply	Auxiliary Supply On	-15V ±0.15V
5	Drive Enable Terminal T20	Enable Inhibit	+10V to +24V 0V
6	Motor Microtherm /Thermistor	Normal Overtemperature	+12V to +15V 0V to 2V
7	At Zero Setpoint	At Zero Setpoint Above Zero Setpoint	+13V±2V 0V
8	At Zero Speed	At Zero Speed Above Zero Speed	+13V±2V 0V
9	Run Terminal T5	Run Inhibit	+24V±4V 0V
10	Health Terminal T19	Healthy Unhealthy	+24V±4V 0V
11	Setpoint Ramp Input Terminal T13	100% Forward Speed Zero Speed 100% Reverse Speed	+10V 0V -10V
12	Positive Trim Setpoint Terminal T10	100% Forward Speed Zero Speed 100% Reverse Speed	+10V 0V -10V
13	Inverted Setpoint Sum Terminal T21	100% Forward Speed Zero Speed 100% Reverse Speed	-10V 0V +10V
14	Negative Trim Setpoint Terminal T17	100% Forward Speed Zero Speed 100% Reverse Speed	-10V 0V +10V

5-3 Diagnostics and Fault Finding

Test Node	Description	Condition	Voltage
15	Total Setpoint Sum Terminal T12	100% Forward Speed Zero Speed 100% Reverse Speed	+10V 0V -10V
16	Speed Feedback	100% Forward Speed Zero Speed 100% Reverse Speed	-2.7V 0V +2.7V
17	Speed Error	Run Steady State Run Transient Stopped Zero Setpoint Stopped +ve Setpoint Stopped -ve Setpoint	Approx. 0V plus Ripple up to $\pm 10V$ 0V up to -10V up to +10V
18	Current Demand	Run Steady State Stopped or Disabled	up to $\pm 10V$ 0V
19	Speed Loop Out	Run Steady State Stopped or Disabled	up to $\pm 10V$ 0V
20	No Connection		
21	No Connection		
22	No Connection		
23	Current Limit Terminal Terminal T7	Open Circuit -110% 7.5V or greater - 150%.	+5.5V +7.5V
24	Main Current Limit P5 Maximum. P5 Minimum.	T7 = 7.5V or greater. 150% Current 0.5% Current	+7.5V +0.025V
25	Total Current Demand (Terminal T7 7.5V or greater -150%.)	Run Transient Positive Bridge at 150% Limit. Negative Bridge at 150% Limit.	up to $\pm 7.5V$ +7.5V -7.5V
26	Current Feedback	Positive Bridge at 100% Negative Bridge at 100%	+1.1V -1.1V
27	Phase Angle	Running 100% Forward Speed. 100% Reverse Speed. Zero Speed	$\pm 10V$ approx +10V approx -10V approx 0V

TROUBLESHOOTING

PROBLEM	POSSIBLE CAUSE	REMEDY
"Power On" LED 1 Not Illuminated	No Auxiliary Supply Available.	Check Auxiliary Supply Availability. Is the Supply Fuse fitted or the Circuit Breaker closed?
	Auxiliary Supply Fuse.	Supply fuse Blown. Investigate Contactor connections or Transformer Tapping Switch position.
	Incorrect Supply Voltage Applied to Controller.	Check that the Supply Voltage is compatible with the Transformer Tapping Switch position.
Illuminated but drive does not operate.	Incorrect Auxiliary Supply Switch Setting.	Correct Auxiliary Supply Switch Setting.
Controller "Trips" Immediately after Drive Run command.	Microtherm not wired.	Connect Microtherm to terminals T22 and T11 or if Microtherm not available link T22 to T11.
"PLL LOCK" LED 4 not illuminated after Drive Run command.	Main Power Supply not present.	1) Main Contactor not Energised. Check Run Command & Contactor wiring.
		2) Is the Supply Fuse fitted or the Circuit Breaker closed?
Motor will not turn after Drive Run Command.	Enable Signal not present.	Check Control Circuit Wiring.
	No Speed Setpoint.	Check Total Setpoint terminal T12. Check Setpoint Pot'meter & Wiring. If using the Setpoint Ramp Input T13 check SW1/6 is OFF.
	No Armature Current.	Check P5 adjustment & External Current Limit Potentiometer setting & wiring (if used).
	No Field.	Check Field AC Supply and Field connections.
	Motor Jammed.	Free Obstruction.
Motor Runs with "Current Limit" LED5 illuminated and Stops after short period with "Stall" LED2 Illuminated	Incorrect Current Limit Setting.	Check P5 setting. Check External Current limit setting & wiring if used.
	Incorrect Current Calibration.	Check Current Calibration Switches SW2, 3 & 4.
	Motor Jammed.	Free Obstruction.
Motor Runs and Stops after short period with "Stall" LED2 Illuminated	Maximum Controller Output Exceeded	Check compatibility of Motor Voltage to Controller Output Voltage.
	Incorrect Feedback Voltage Calibration	Check Feedback Voltage Calibration Switches SW1/1 & SW1/2. Note these Switches must be set for both Tachogenerator & Armature Voltage Feedback.
	Faulty Tachogenerator and/or Coupling.	Check Tachogenerator (use Armature Voltage Feedback Temporarily).

5-5 Diagnostics and Fault Finding

PROBLEM	POSSIBLE CAUSE	REMEDY
Motor Runs but stops after a period with "Overcurrent Trip" LED 3 Illuminated.	Overcurrent.	Check Motor wiring and Motor for earth faults. Check controller for Faulty Thyristor Devices.
Motor Runs but stops after a period indicating Controller Unhealthy.	Motor Overtemperature trip from Motor Microtherm.	Check cooling Fan if used. Fan rotation may be reversed giving airflow but insufficient for adequate cooling. Check Cooling path.
	Tachogenerator Feedback. Incorrect Tachogenerator Polarity or Open Circuit Tachogenerator	Check Tachogenerator viability and connectivity. Check Speed Feedback Calibration Switches. Check Max Speed Calibrate Potentiometer P10.
Motor runs at Full Speed only	Armature Voltage Feedback.	Check Speed Feedback Calibration Switches. Check Max Speed Calibrate Potentiometer P10.
	Open Circuit Speed Setpoint Potentiometer	Check Terminal 13 or 10 as appropriate
	Zero Speed Offset Adjustment	Adjust P11 to give Zero Speed
Motor Speed unstable at Constant Speed Setpoint.	Stability Adjustment.	See General Running performance adjustments Chapter 4.
	Current Stability	Adjust Current Loop Stability Potentiometers P6 & P7.
	Speed Stability	Adjust Speed Loop Stability Potentiometers P3 & P4.
	IR Compensation.	No IR compensation for Tachogenerator Feedback. Reduce P8 for Armature Voltage Feedback
Drive does not produce required current.	Drive incorrectly calibrated.	Set SW2, SW3, SW4 to correct calibration current.
	Current calibration set incorrectly.	The maximum current that the drive can produce is its rated current. Setting the calibration above this can cause damage. Settings above 39.9Amps will cause erroneous calibration values. DO NOT CALIBRATE THE DRIVE ABOVE RATED CURRENT.
	Current Limit set wrongly.	Check the current limit diagnostic 23 and the main current limit diagnostic 24. Adjust P5 and external current limit pot (if used).

Chapter 6 Service and Repair

The product has no user serviceable parts and should be returned to SSD Drives for repair. The product should be returned in the original packaging if possible or else reasonable care should be taken in the packing of the product to ensure that no transport damage be incurred.

Technical Support can be obtained by contacting SSD Drives at the address given or your local supplier.

DISPOSAL

This product contains materials which are consignable waste under the Special Waste Regulations 1996 which complies with the EC Hazardous Waste Directive – Directive 91/689/EEC.

We recommend you dispose of the appropriate materials in accordance with the valid environmental control laws. The following table shows which materials can be recycled and which have to be disposed of in a special way.

Material	Recycle	Disposal
metal	yes	no
plastics material	yes	no
printed circuit board	no	yes

The printed circuit board should be disposed of in one of two ways:

1. High temperature incineration (minimum temperature 1200°C) by an incinerator authorised under parts A or B of the Environmental Protection Act.
2. Disposal in an engineered land fill site that is licensed to take aluminium electrolytic capacitors. Do not dispose of in a land fill site set aside for domestic waste.

Packaging

During transport our products are protected by suitable packaging. This is entirely environmentally compatible and should be taken for central disposal as secondary raw material.

ISS.	MODIFICATION	ECN No.	DATE	DRAWN	CHK'D
	514C Product Manual. Sheet 1 filed in drawing office.				
4	Added to Product Identification diagram "Auxiliary Supply Selector Switch". Page 3-3 Added to Recommendations, "Unused Analogue ... interference". Page 4-4 Added to Power-Up, v), "Note ... switch". Page 4-6 Added to 15. "Note ... change." Page 5-4 Added to Troubleshooting "Illuminated but Drive does not operate".	12307	15.4.98	FEP	GDR
5	Page 1-4 New CE EMC Declarations. Pages 1-8 changed Terminal Tightening Torque from 0.6 Nm to 0.45 and 4.5 lbf-in to 4.0. 0.6 Nm to 0.5 and added (UL open-type). Page 1-11 Added "Overvoltage". Page 3-4 changed Terminal tightening Torque Control settings from 0.6 to 0.45, 0.4 to 0.33, 4.5 to 4.0 and Auxiliary settings from 0.6 to 0.5 and 0.4 to 0.375. Page 3-5 Re-written for UL Compliance Page 6-1 Added Disposal information. Address list added to back cover.	13908 13831 " " "	15.1.01	FEP	CM
6	New Certificates. Company name change and new Safety Information	19887 (19591)	5.7.07	CM	GDR
FIRST USED ON		MODIFICATION RECORD			
		514C Product Manual			
		DRAWING NUMBER			SHT. 2
		ZZ463296			OF 2