

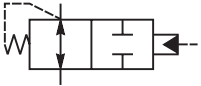

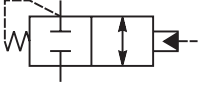

	SERIES	CAVITY	DESCRIPTION	FLOW LPM/GPM	PRESSURE BAR/PSI	PAGE NO.
	R04C3	C10-3	2 Way, Normally Open, Pilot to Close	80/21	420/6000	DC1-DC2
	R04D3	C10-3	2 Way, Normally Closed, Pilot to Open	100/26	420/6000	DC3
	R04A4	C10-4	2 Way, Normally Open, Pilot to Close, External Vent	80/21	420/6000	DC4
	R04B4	C10-4	2 Way, Normally Closed, Pilot to Open, External Vent	80/21	420/6000	DC5
	DH103	C10-4	3 Way, External Pilot, Normally Open, Vent to Atmosphere	38/10	240/3500	DC7-DC8
	N04A4	C10-4	3 Way, Internal Vent, External Pilot	90/24	420/6000	DC9
	N04B4	C10-4	3 Way, Internal Vent, External Pilot	90/24	420/6000	DC10
	N04G4	C10-4	3 Way, Vent to Atmosphere, External Pilot	85/22	420/6000	DC11
	N04H4	C10-4	3 Way, Vent to Atmosphere, External Pilot	85/22	420/6000	DC12
	N5A125	5A	3 Way, 2 Position, External Drain, Open Transition	160/42	420/6000	DC13
	N5A300	100-1	3 Way, 2 Position, External Drain, Open Transition	400/105	420/6000	DC14
	N5B125	5A	3 Way, 2 Position, External Drain, Closed Transition	160/42	420/6000	DC15
	N5B300	100-1	3 Way, 2 Position, External Drain, Closed Transition	400/105	420/6000	DC16
	N5C125	5A	3 Way, 2 Position, External Drain, Diverter Valve, Normally Open	160/42	420/6000	DC17
	N5C300	100-1	3 Way, 2 Position, External Drain, Diverter Valve, Normally Open	400/105	420/6000	DC18
	N5D125	5A	3 Way, 2 Position, External Drain, Diverter Valve, Normally Closed	160/42	420/6000	DC19
	N5D300	100-1	3 Way, 2 Position, External Drain, Diverter Valve, Normally Closed	400/105	420/6000	DC20

- CV**
Check Valves
- SH**
Shuttle Valves
- LM**
Load/Motor Controls
- FC**
Flow Controls
- PC**
Pressure Controls
- LE**
Logic Elements
- DC**
Directional Controls
- MV**
Manual Valves
- SV**
Solenoid Valves
- PV**
Proportional Valves
- CE**
Coils & Electronics
- BC**
Bodies & Cavities
- TD**
Technical Data

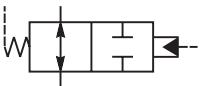
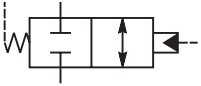

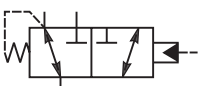
Technical Information

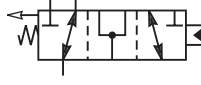
- CV** Check Valves
- SH** Shuttle Valves
- LM** Load/Motor Controls
- FC** Flow Controls
- PC** Pressure Controls
- LE** Logic Elements
- DC** Directional Controls
- MV** Manual Valves
- SV** Solenoid Valves
- PV** Proportional Valves
- CE** Coils & Electronics
- BC** Bodies & Cavities
- TD** Technical Data

General Description

Diverter Valve, Normally Open, Pilot to Close Vent and Pressure Compensating Flow Control Element.

Features

- Two switching and one compensating spring available
- Very accurate flow regulation when used with separate orifice
- Sealed pilot option available
- Industry common cavity
- Hardened working parts for maximum durability
- All external parts zinc plated

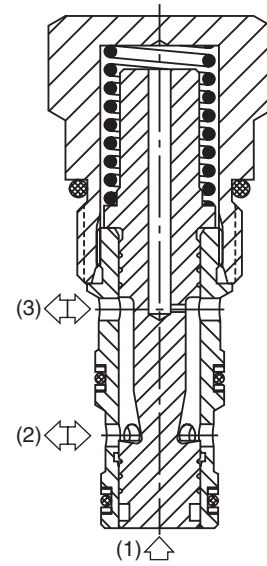
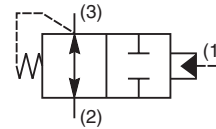
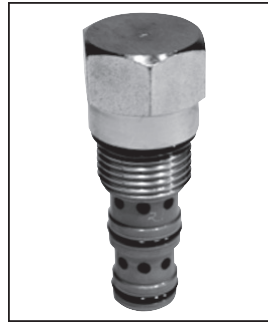

Specifications

Rated Flow	80 LPM (21 GPM)
Nominal Flow @ 7 Bar (100 PSI)	Diverter - 40 LPM (10 GPM) Compensator - See Application
Maximum Inlet Pressure	420 Bar (6000 PSI)
Pilot Switching Pressure	See ordering information
Cartridge Material	All parts steel. All operating parts hardened steel.
Operating Temp. Range/Seals	-40°C to +93.3°C (Nitrile, Buna-N) (-40°F to +200°F) -31.7°C to +121.1°C (Fluorocarbon) (-25°F to +250°F)
Fluid Compatibility/Viscosity	Mineral-based or synthetic with lubricating properties at viscosities of 45 to 2000 SSU (6 to 420 cSt)
Filtration	ISO code 16/13, SAE Class 4 or better
Approx. Weight	.15 kg (.33 lbs.)
Cavity	C10-3 (See BC Section for more details)

Performance Curve

Diverting Pressure Drop (Through cartridge only)

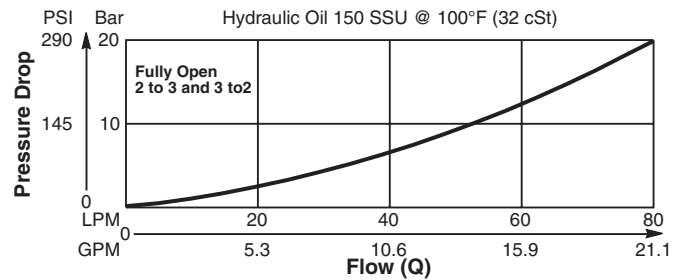

Application

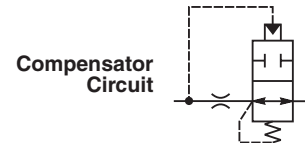

Compensating Flow Regulation Performance 3 to 2

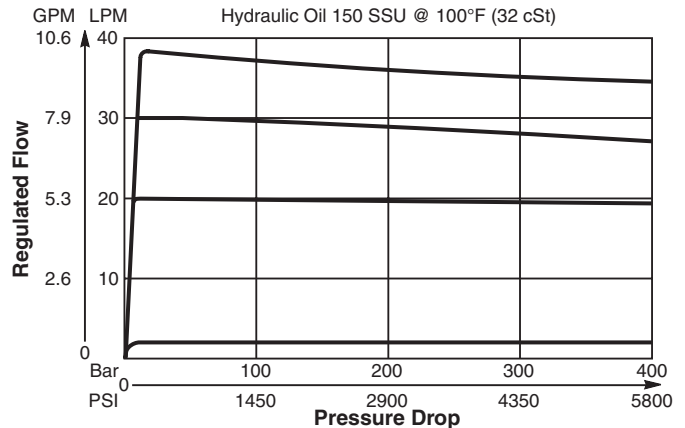

Dimensions Millimeters (Inches)

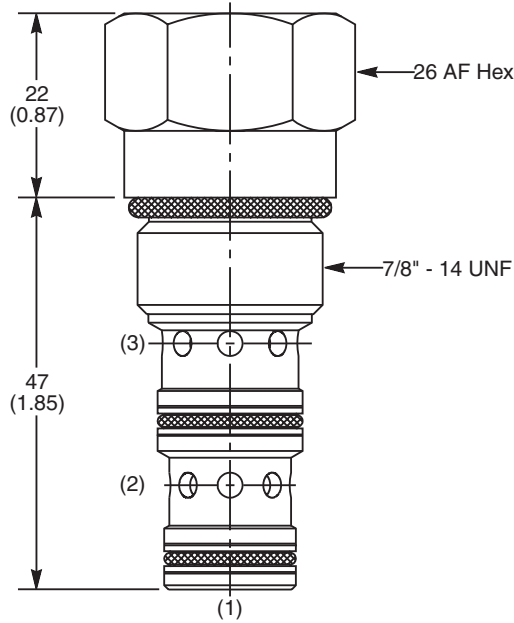

Ordering Information

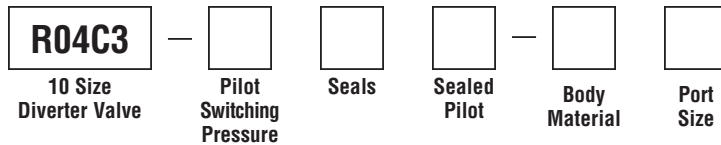

Code	Switching Pressure
For Switching	
5.0	5.0 Bar (73 PSI) Std.
10.0	10.0 Bar (145 PSI)
For Flow Regulation	
7.7	7.7 Bar (112 PSI)

If no switching pressure is specified, valve will be supplied as R04C3-5.0N

Code	Sealed Pilot
Omit	If not required
S	Sealed Pilot

Code	Body Material
Omit	Steel
A	Aluminum

Code	Port Size	Body Part No.
Omit	Cartridge Only	
4P	1/4" NPTF	(B10-3-*4P)
6P	3/8" NPTF	(B10-3-*6P)
8P	1/2" NPTF	(B10-3-*8P)
6T	SAE-6	(B10-3-*6T)
8T	SAE-8	(B10-3-*8T)
6B	3/8" BSPG	(B10-3-6B)†
8B	1/2" BSPG	(B10-3-*8B)

* Add "A" for aluminum, omit for steel.
 † Steel bodies only.

Code	Seals / Kit No.
N	Nitrile, Buna-N / (SK30505N-1)
V	Fluorocarbon / (SK30505V-1)

- CV**
Check Valves
- SH**
Shuttle Valves
- LM**
Load/Motor Controls
- FC**
Flow Controls
- PC**
Pressure Controls
- LE**
Logic Elements
- DC**
Directional Controls
- MV**
Manual Valves
- SV**
Solenoid Valves
- PV**
Proportional Valves
- CE**
Coils & Electronics
- BC**
Bodies & Cavities
- TD**
Technical Data

- CV** Check Valves
- SH** Shuttle Valves
- LM** Load/Motor Controls
- FC** Flow Controls
- PC** Pressure Controls
- LE** Logic Elements
- DC** Directional Controls
- MV** Manual Valves
- SV** Solenoid Valves
- PV** Proportional Valves
- CE** Coils & Electronics
- BC** Bodies & Cavities
- TD** Technical Data

General Description

Diverter Valve, Normally Closed, Pilot to Open.

Features

- Two switching pressures available
- Sealed pilot option available
- Hardened working parts for maximum durability
- All external parts zinc plated

Performance Curve

Pressure Drop vs. Flow (Through cartridge only)

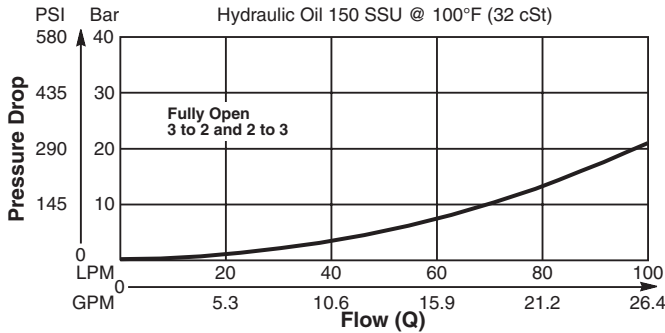

Application Note

To fully open, the valve requires at least a further 2 Bar (29 PSI) above the pilot switching pressure.

Specifications

Rated Flow	100 LPM (22 GPM)
Nominal Flow @ 7 Bar (100 PSI)	60 LPM (16 GPM)
Maximum Inlet Pressure	420 Bar (6000 PSI)
Pilot Switching Pressure	See ordering information
Cartridge Material	All parts steel. All operating parts hardened steel.
Operating Temp. Range/Seals	-40°C to +93.3°C (Nitrile, Buna-N) (-40°F to +200°F) -31.7°C to +121.1°C (Fluorocarbon) (-25°F to +250°F)
Fluid Compatibility/Viscosity	Mineral-based or synthetic with lubricating properties at viscosities of 45 to 2000 SSU (6 to 420 cSt)
Filtration	ISO code 16/13, SAE Class 4 or better
Approx. Weight	.15 kg (.33 lbs.)
Cavity	C10-3 (See BC Section for more details)

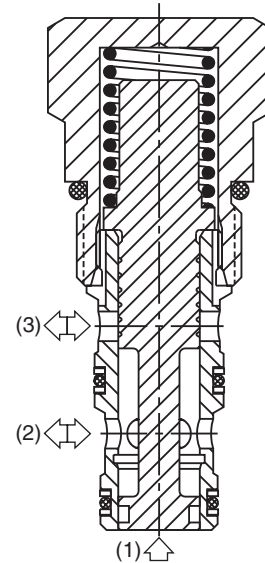
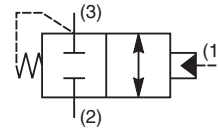
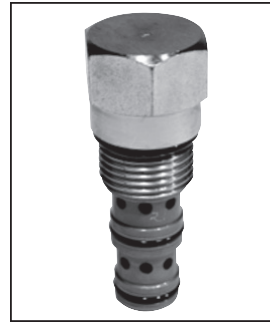

Dimensions

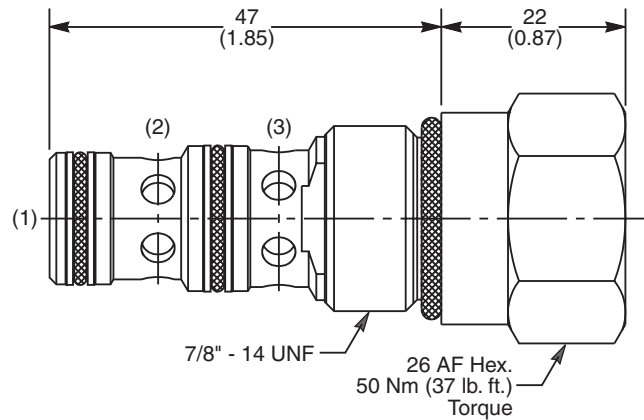

Ordering Information

R04D3	<input type="checkbox"/>	<input type="checkbox"/>	<input type="checkbox"/>	<input type="checkbox"/>	<input type="checkbox"/>
10 Size Diverter Valve	Pilot Switching Pressure	Seals	Sealed Pilot	Body Material	Port Size

Code	Switching Pressure
5.0	5.0 Bar (73 PSI) Std.
10.0	10.0 Bar (145 PSI)

If no switching pressure is specified, valve will be supplied as R04D3-5.0N

Code	Seals / Kit No.
N	Nitrile, Buna-N / (SK30505N-1)
V	Fluorocarbon / (SK30505V-1)

Code	Sealed Pilot
Omit	If not required
S	Sealed Pilot

Code	Body Material
Omit	Steel
A	Aluminum

Code	Port Size	Body Part No.
Omit	Cartridge Only	
4P	1/4" NPTF	(B10-3-*4P)
6P	3/8" NPTF	(B10-3-*6P)
8P	1/2" NPTF	(B10-3-*8P)
6T	SAE-6	(B10-3-*6T)
8T	SAE-8	(B10-3-*8T)
6B	3/8" BSPG	(B10-3-6B)†
8B	1/2" BSPG	(B10-3-*8B)

* Add "A" for aluminum, omit for steel.
 † Steel bodies only.

General Description

Diverter Valve, Normally Open, 2-Way with External Pilot and Vent.

Features

- High flow capacity
- Two switching pressures
- Sealed pilot option available
- Hardened working parts for maximum durability
- All external parts zinc plated

Performance Curve

Pressure Drop vs. Flow (Through cartridge only)

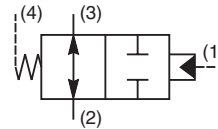
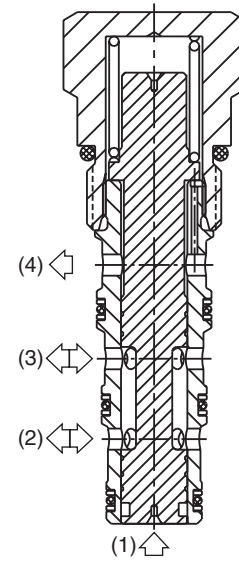
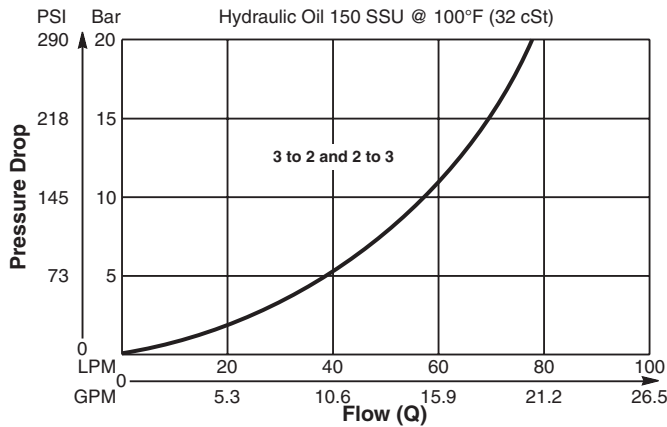

Dimensions Millimeters (Inches)

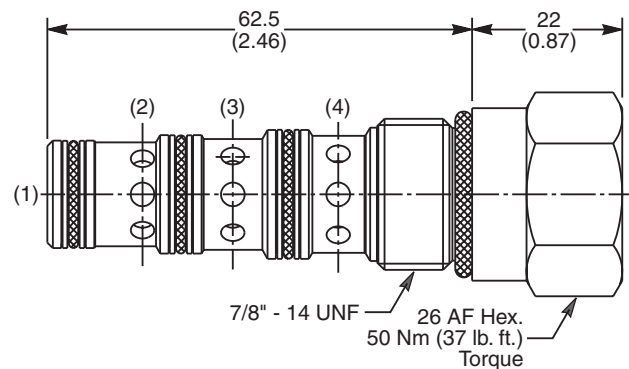

Specifications

Rated Flow	80 LPM (21 GPM)
Nominal Flow @ 7 Bar (100 PSI)	47 LPM (12 GPM)
Maximum Inlet Pressure	420 Bar (6000 PSI)
Pilot Switching Pressure	See ordering information
Cartridge Material	All parts steel. All operating parts hardened steel.
Operating Temp. Range/Seals	-40°C to +93.3°C (Nitrile, Buna-N) (-40°F to +200°F) -31.7°C to +121.1°C (Fluorocarbon) (-25°F to +250°F)
Fluid Compatibility/Viscosity	Mineral-based or synthetic with lubricating properties at viscosities of 45 to 2000 SSU (6 to 420 cSt)
Filtration	ISO code 16/13, SAE Class 4 or better
Approx. Weight	.17 kg (.37 lbs.)
Cavity	C10-4 (See BC Section for more details)

Ordering Information

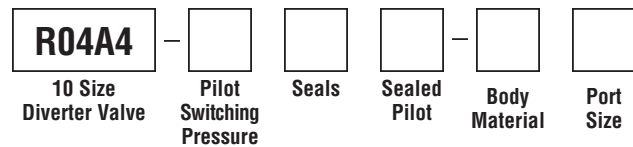

Code	Switching Pressure
5.0	5.0 Bar (73 PSI) Std.
10.0	10.0 Bar (145 PSI)

If no switching pressure is specified, valve will be supplied as R04A4-5.0N

Code	Seals / Kit No.
N	Nitrile, Buna-N / (SK30506N-1)
V	Fluorocarbon / (SK30506V-1)

Code	Sealed Pilot
Omit	If not required
S	Sealed Pilot

Code	Body Material
Omit	Steel
A	Aluminum

Code	Port Size	Body Part No.
Omit	Cartridge Only	
6P	3/8" NTPF	(B10-4-*6P)
6T	SAE-6	(B10-4-*6T)
8T	SAE-8	(B10-4-*8T)
6B	3/8" BSPG	(B10-4-6B)†

* Add "A" for aluminum, omit for steel.
 † Steel bodies only



- CV**
- Check Valves
- SH**
- Shuttle Valves
- LM**
- Load/Motor Controls
- FC**
- Flow Controls
- PC**
- Pressure Controls
- LE**
- Logic Elements
- DC**
- Directional Controls
- MV**
- Manual Valves
- SV**
- Solenoid Valves
- PV**
- Proportional Valves
- CE**
- Coils & Electronics
- BC**
- Bodies & Cavities
- TD**
- Technical Data

- CV** Check Valves
- SH** Shuttle Valves
- LM** Load/Motor Controls
- FC** Flow Controls
- PC** Pressure Controls
- LE** Logic Elements
- DC** Directional Controls
- MV** Manual Valves
- SV** Solenoid Valves
- PV** Proportional Valves
- CE** Coils & Electronics
- BC** Bodies & Cavities
- TD** Technical Data

General Description

Diverter Valve, Normally Closed, 2-Way with External Pilot and Vent.

Features

- High flow capacity
- Two switching pressures available
- Sealed pilot option available
- Hardened working parts for maximum durability
- All external parts zinc plated

Performance Curve

Pressure Drop vs. Flow (Through cartridge only)

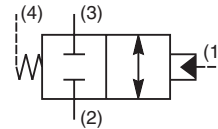
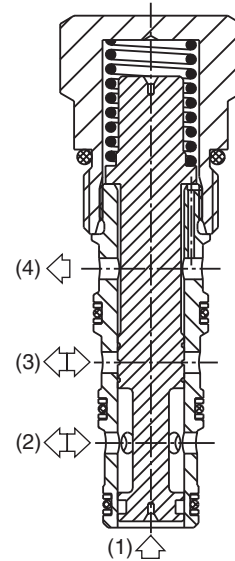
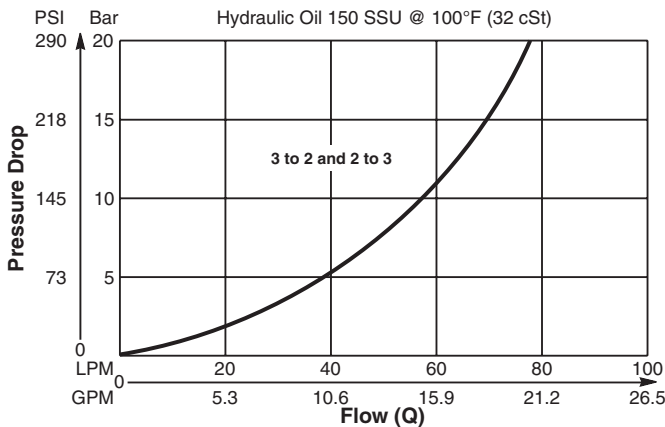

Dimensions

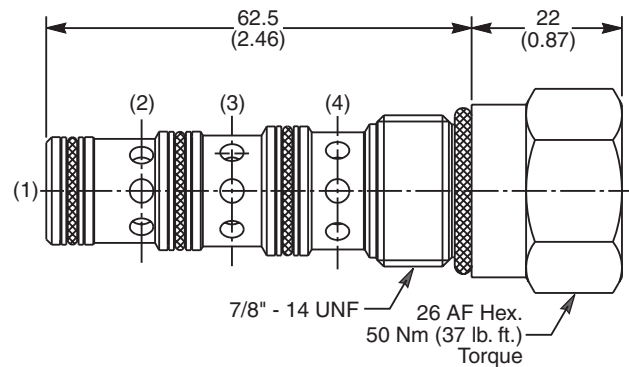

Specifications

Rated Flow	80 LPM (21 GPM)
Nominal Flow @ 7 Bar (100 PSI)	47 LPM (12 GPM)
Maximum Inlet Pressure	420 Bar (6000 PSI)
Pilot Switching Pressure	See ordering information
Cartridge Material	All parts steel. All operating parts hardened steel.
Operating Temp. Range/Seals	-40°C to +93.3°C (Nitrile, Buna-N) (-40°F to +200°F) -31.7°C to +121.1°C (Fluorocarbon) (-25°F to +250°F)
Fluid Compatibility/Viscosity	Mineral-based or synthetic with lubricating properties at viscosities of 45 to 2000 SSU (6 to 420 cSt)
Filtration	ISO code 16/13, SAE Class 4 or better
Approx. Weight	.17 kg (.37 lbs.)
Cavity	C10-4 (See BC Section for more details)

Ordering Information

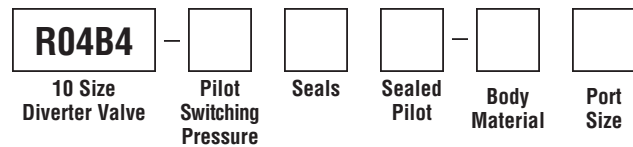

Code	Switching Pressure
5.0	5.0 Bar (73 PSI) Std.
10.0	10.0 Bar (145 PSI)

If no switching pressure is specified, valve will be supplied as R04B4-5.0N

Code	Body Material
Omit	Steel
A	Aluminum

Code	Seals / Kit No.
N	Nitrile, Buna-N / (SK30506N-1)
V	Fluorocarbon / (SK30506V-1)

Code	Port Size	Body Part No.
Omit	Cartridge Only	
6P	3/8" NTPF	(B10-4-*6P)
6T	SAE-6	(B10-4-*6T)
8T	SAE-8	(B10-4-*8T)
6B	3/8" BSPG	(B10-4-6B)†

** Add "A" for aluminum, omit for steel.
 † Steel bodies only*

Code	Sealed Pilot
Omit	If not required
S	Sealed Pilot

Technical Information

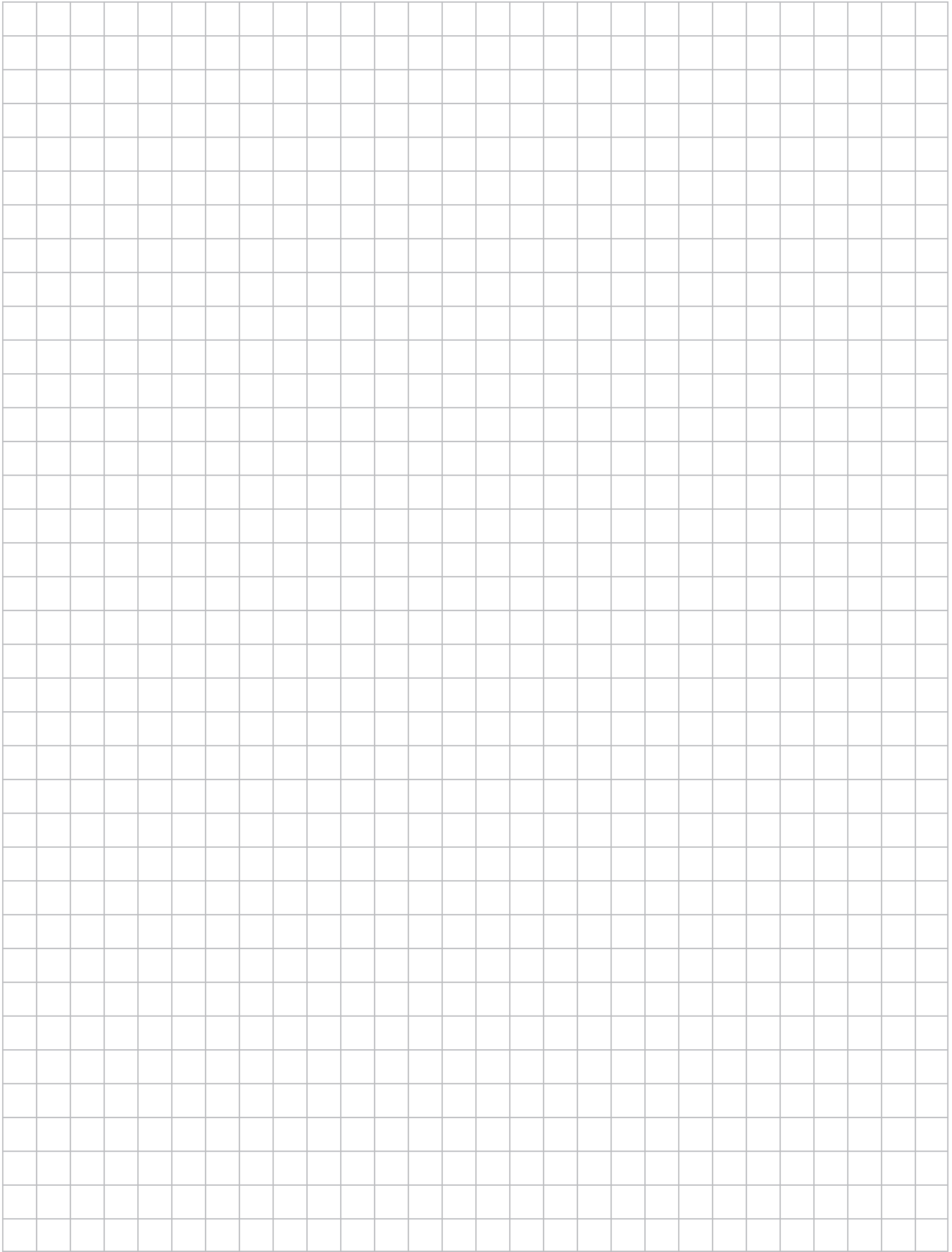

CV

Check
Valves

SH

Shuttle
Valves

LM

Load/Motor
Controls

FC

Flow
Controls

PC

Pressure
Controls

LE

Logic
Elements

DC

Directional
Controls

MV

Manual
Valves

SV

Solenoid
Valves

PV

Proportional
Valves

CE

Coils &
Electronics

BC

Bodies &
Cavities

TD

Technical
Data

Technical Information

- CV** Check Valves
- SH** Shuttle Valves
- LM** Load/Motor Controls
- FC** Flow Controls
- PC** Pressure Controls
- LE** Logic Elements
- DC** Directional Controls
- MV** Manual Valves
- SV** Solenoid Valves
- PV** Proportional Valves
- CE** Coils & Electronics
- BC** Bodies & Cavities
- TD** Technical Data

General Description

3-Way Pilot Operated Spool Valve. The DH103A/B/C Series Valves are used in normally closed or normally open directional control three way circuits requiring remote pilot actuation. The DH103-D/E Series Valves are used to direct flow alternately from either side of a closed loop transmission for cooling or filtering. All external parts are zinc plated.

Operation

DH103A (Normally Open)

- Neutral (Deactivated)
Port (3) open to port (2), inlet port (4) is blocked.
 - Activated with pilot pressure at port (1):
Port (4) open to port (3), port (2) blocked.
- Note: There is an air breather vent plug in the end cap to allow for air pressure equalization in the spring chamber

DH103B (Normally Closed)

- Neutral (Deactivated)
Port (4) open to port (3), inlet port (2) is blocked.
- Activated with pilot pressure at port (1):
Port (3) open to port (2), port (4) blocked.

DH103C (Normally Open)

- Neutral (Deactivated)
Port (3) open to port (2), inlet port (4) is blocked.
- Activated with pilot pressure at port (1):
Port (4) open to port (3), port (2) blocked.

Specifications

Nominal Flow	38 LPM (10 GPM)
Maximum Inlet Pressure	240 Bar (3500 PSI)
Leakage at 150 SSU (32 cSt)	50 cc/min. at 240 Bar (3500 PSI)
Cartridge Material	All parts steel. All operating parts hardened steel.
Operating Temp. Range/Seals	-40°C to +93.3°C (Nitrile) (-40°F to +200°F) -31.7°C to +121.1°C (Fluorocarbon) (-25°F to +250°F)
Fluid Compatibility/ Viscosity	Mineral-based or synthetic with lubricating properties at viscosities of 45 to 2000 SSU (6 to 420 cSt)
Filtration	ISO code 16/13, SAE Class 4 or better
Approx. Weight	0.23 kg (0.5 lbs.)
Cavity	C10-4 (See BC Section for more details)
Form Tool	Rougher NFT10-4R Finisher NFT10-4F



"A" SPOOL - DH103A

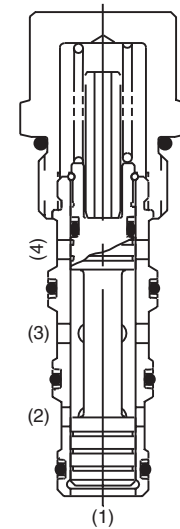
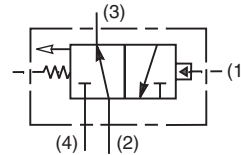

"A" SPOOL - DH103A

"B" SPOOL - DH103B

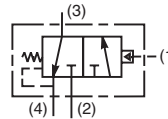
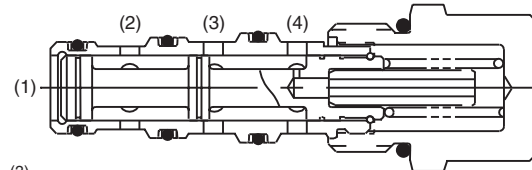

"C" SPOOL - DH103C

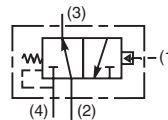
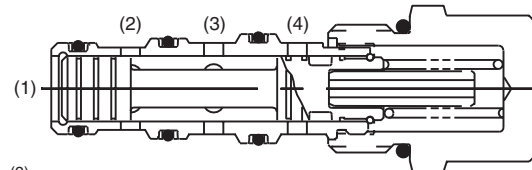

Performance Curve

Flow vs. Pressure Drop (Through cartridge only)

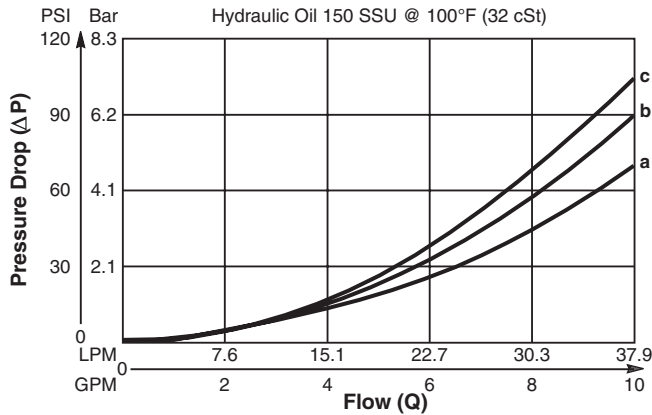

FLOW DIRECTION \ SPOOL NO.	A	B	C
SPOOL SHIFTED	3 → 4 c	2 → 3 d	3 → 4 c
SPOOL NEUTRAL	2 → 3 a	3 → 4 b	2 → 3 a

Dimensions Millimeters (Inches)

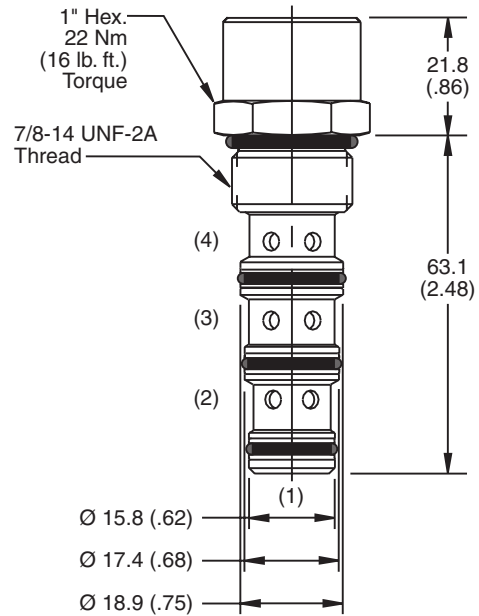

Ordering Information

DH103

10 Size Pilot Operated Spool Valve

Spool Type Pressure Differential Seals Body Material Port Size

Code / Spool Type	Diagram
A Normally open 2 position, vent to atmosphere.	
B Normally closed 2 position, internally drain.	
C Normally open, 2 position, internally drain.	

Code	Pressure Differential
Omit	5.5 Bar (80 PSI)
04	2.8 Bar (40 PSI)
16	11 Bar (160 PSI)

Code	Seals / Kit. No.
Omit	Nitrile / (SK10-4N)
V	Fluorocarbon / (SK10-4V)

Code	Body Material
Omit	Steel
A	Aluminum

Code	Port Size	Body Part No.
Omit	Cartridge Only	
4P	1/4" NPTF	(B10-4-*4P)
6P	3/8" NPTF	(B10-4-*6P)
8P	1/2" NPTF	(B10-4-*6P)
6T	SAE - 6	(B10-4-*6T)
8T	SAE - 8	(B10-4-*8T)
6B	3/8" BSPG	(B10-4-6B)†
8B	1/2" BSPG	(B10-4-*8B)

* Add "A" for aluminum, omit for steel.
 † Steel body only.

- CV** Check Valves
- SH** Shuttle Valves
- LM** Load/Motor Controls
- FC** Flow Controls
- PC** Pressure Controls
- LE** Logic Elements
- DC** Directional Controls
- MV** Manual Valves
- SV** Solenoid Valves
- PV** Proportional Valves
- CE** Coils & Electronics
- BC** Bodies & Cavities
- TD** Technical Data

Technical Information

- CV** Check Valves
- SH** Shuttle Valves
- LM** Load/Motor Controls
- FC** Flow Controls
- PC** Pressure Controls
- LE** Logic Elements
- DC** Directional Controls
- MV** Manual Valves
- SV** Solenoid Valves
- PV** Proportional Valves
- CE** Coils & Electronics
- BC** Bodies & Cavities
- TD** Technical Data

General Description

Pilot Operated Directional Valve, 3-Way External Pilot, Internal Vent.

Features

- High flow capacity
- Two switching pressures available
- Sealed pilot option available
- Hardened working parts for maximum durability
- All external parts zinc plated

Performance Curve

Pressure Drop vs. Flow (Through cartridge only)

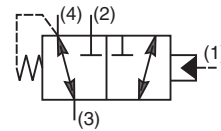
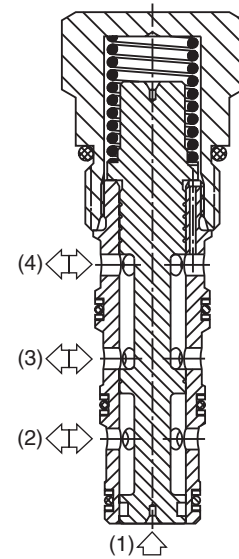
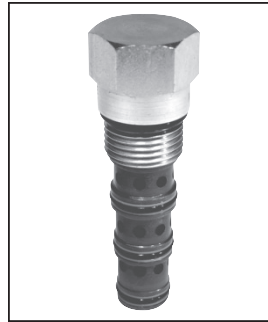
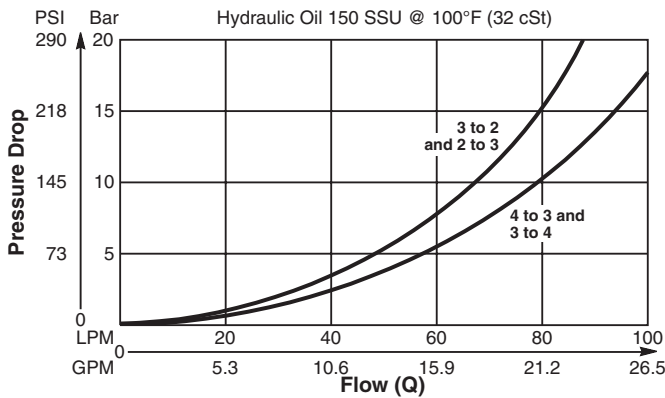

Dimensions Millimeters (Inches)

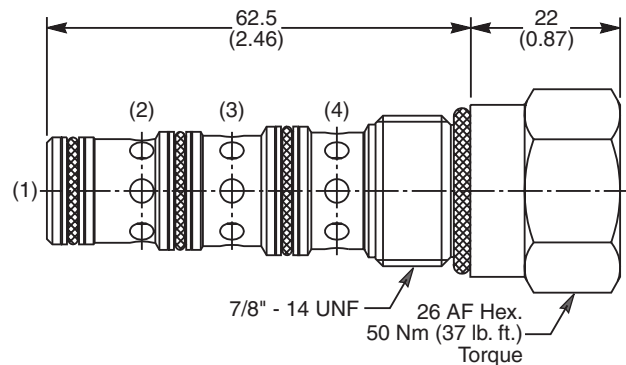

Specifications

Rated Flow	90 LPM (24 GPM)
Nominal Flow @ 7 Bar (100 PSI)	50 LPM (13 GPM)
Maximum Inlet Pressure	420 Bar (6000 PSI)
Pilot Switching Pressure	See ordering information
Cartridge Material	All parts steel. All operating parts hardened steel.
Operating Temp. Range/Seals	-40°C to +93.3°C (Nitrile, Buna-N) (-40°F to +200°F) -31.7°C to +121.1°C (Fluorocarbon) (-25°F to +250°F)
Fluid Compatibility/Viscosity	Mineral-based or synthetic with lubricating properties at viscosities of 45 to 2000 SSU (6 to 420 cSt)
Filtration	ISO code 16/13, SAE Class 4 or better
Approx. Weight	.17 kg (.37 lbs.)
Cavity	C10-4 (See BC Section for more details)

Ordering Information

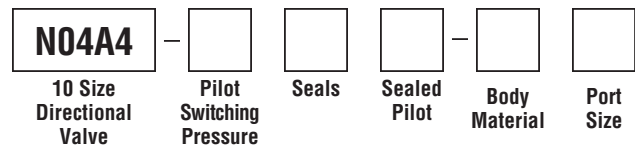

Code	Switching Pressure
5.0	5.0 Bar (73 PSI) Std.
10.0	10.0 Bar (145 PSI)

If no switching pressure is specified, valve will be supplied as N04A4-5.0N

Code	Body Material
Omit	Steel
A	Aluminum

Code	Seals / Kit No.
N	Nitrile, Buna-N / (SK30506N-1)
V	Fluorocarbon / (SK30506V-1)

Code	Port Size	Body Part No.
Omit	Cartridge Only	
6P	3/8" NTPF	(B10-4-*6P)
6T	SAE-6	(B10-4-*6T)
8T	SAE-8	(B10-4-*8T)
6B	3/8" BSPG	(B10-4-6B)†

* Add "A" for aluminum, omit for steel.
† Steel bodies only

Code	Sealed Pilot
Omit	If not required
S	Sealed Pilot



General Description

Pilot Operated Directional Valve, 3-Way External Pilot, Internal Vent.

Features

- High flow capacity
- Two switching pressures available
- Sealed pilot option available
- Hardened working parts for maximum durability
- All external parts zinc plated

Performance Curve

Pressure Drop vs. Flow (Through cartridge only)

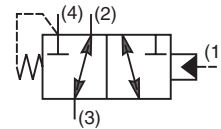
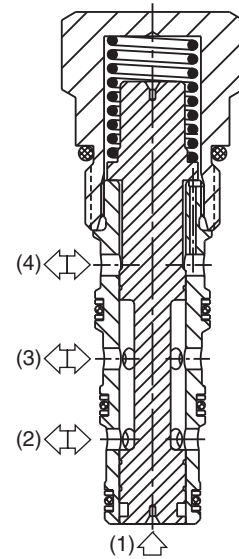
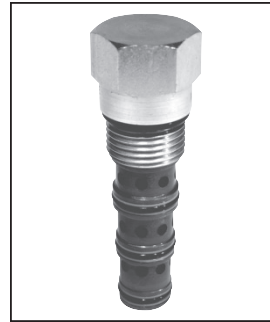
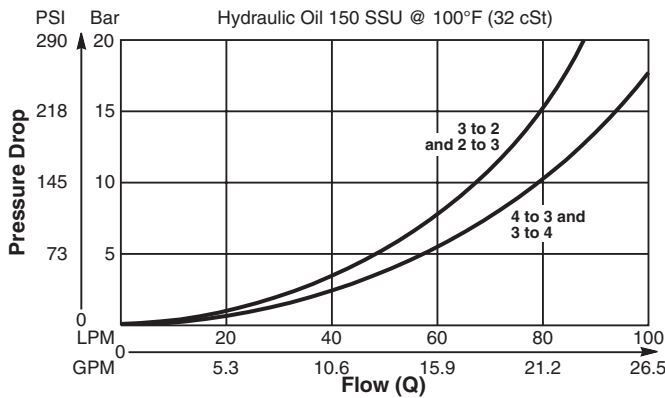

Dimensions Millimeters (Inches)

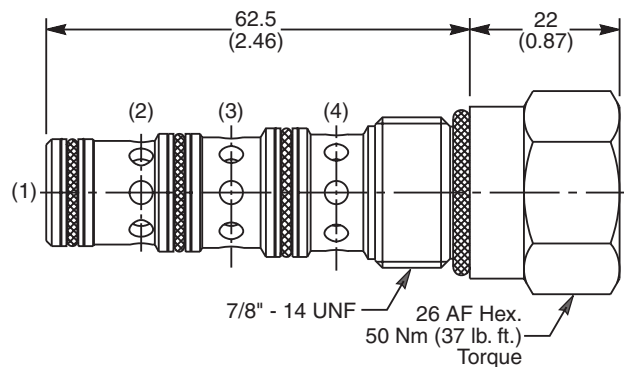

Specifications

Rated Flow	90 LPM (24 GPM)
Nominal Flow @ 7 Bar (100 PSI)	50 LPM (13 GPM)
Maximum Inlet Pressure	420 Bar (6000 PSI)
Pilot Switching Pressure	See ordering information
Cartridge Material	All parts steel. All operating parts hardened steel.
Operating Temp. Range/Seals	-40°C to +93.3°C (Nitrile, Buna-N) (-40°F to +200°F) -31.7°C to +121.1°C (Fluorocarbon) (-25°F to +250°F)
Fluid Compatibility/Viscosity	Mineral-based or synthetic with lubricating properties at viscosities of 45 to 2000 SSU (6 to 420 cSt)
Filtration	ISO code 16/13, SAE Class 4 or better
Approx. Weight	.17 kg (.37 lbs.)
Cavity	C10-4 (See BC Section for more details)

Ordering Information

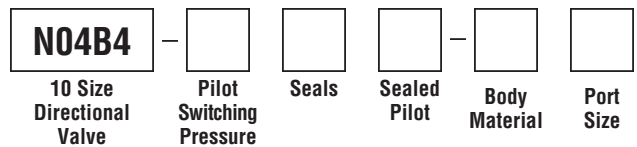

Code	Switching Pressure
5.0	5.0 Bar (73 PSI) Std.
10.0	10.0 Bar (145 PSI)

If no switching pressure is specified, valve will be supplied as N04B4-5.0N

Code	Seals / Kit No.
N	Nitrile, Buna-N / (SK30506N-1)
V	Fluorocarbon / (SK30506V-1)

Code	Sealed Pilot
Omit	If not required
S	Sealed Pilot

Code	Body Material
Omit	Steel
A	Aluminum

Code	Port Size	Body Part No.
Omit	Cartridge Only	
6P	3/8" NTPF	(B10-4-*6P)
6T	SAE-6	(B10-4-*6T)
8T	SAE-8	(B10-4-*8T)
6B	3/8" BSPG	(B10-4-6B)†

* Add "A" for aluminum, omit for steel.
 † Steel bodies only



- CV**
- Check Valves
- SH**
- Shuttle Valves
- LM**
- Load/Motor Controls
- FC**
- Flow Controls
- PC**
- Pressure Controls
- LE**
- Logic Elements
- DC**
- Directional Controls
- MV**
- Manual Valves
- SV**
- Solenoid Valves
- PV**
- Proportional Valves
- CE**
- Coils & Electronics
- BC**
- Bodies & Cavities
- TD**
- Technical Data

Technical Information

- CV** Check Valves
- SH** Shuttle Valves
- LM** Load/Motor Controls
- FC** Flow Controls
- PC** Pressure Controls
- LE** Logic Elements
- DC** Directional Controls
- MV** Manual Valves
- SV** Solenoid Valves
- PV** Proportional Valves
- CE** Coils & Electronics
- BC** Bodies & Cavities
- TD** Technical Data

General Description

Pilot Operated Directional Valve, 3-Way External Pilot Vented to Atmosphere. Open Transition Feature.

Features

- High flow capacity
- Two switching pressures available
- Sealed pilot option available
- Hardened working parts for maximum durability
- All external parts zinc plated

Performance Curve

Pressure Drop vs. Flow (Through cartridge only)

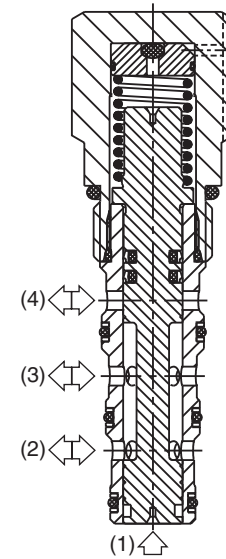
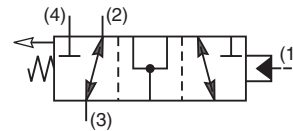
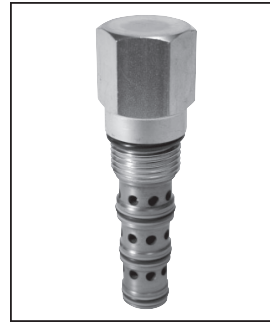
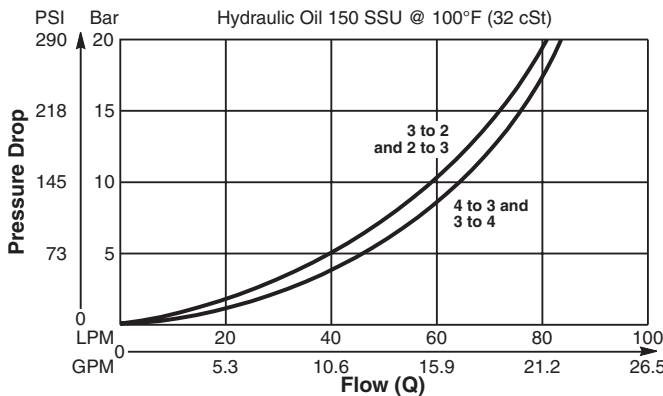

Dimensions Millimeters (Inches)

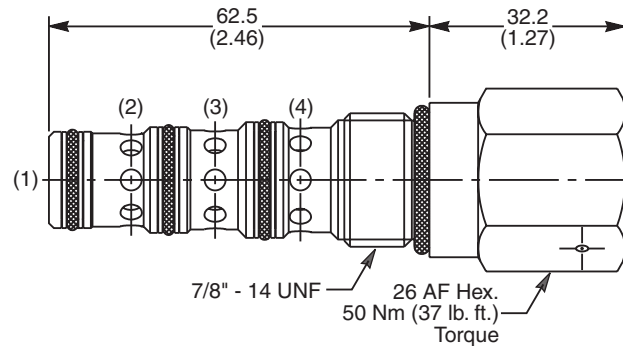

Specifications

Rated Flow	85 LPM (22.5 GPM)
Nominal Flow @ 7 Bar (100 PSI)	50 LPM (13 GPM)
Maximum Inlet Pressure	420 Bar (6000 PSI)
Pilot Switching Pressure	See ordering information
Cartridge Material	All parts steel. All operating parts hardened steel.
Operating Temp. Range/Seals	-40°C to +93.3°C (Nitrile, Buna-N) (-40°F to +200°F) -31.7°C to +121.1°C (Fluorocarbon) (-25°F to +250°F)
Fluid Compatibility/Viscosity	Mineral-based or synthetic with lubricating properties at viscosities of 45 to 2000 SSU (6 to 420 cSt)
Filtration	ISO code 16/13, SAE Class 4 or better
Approx. Weight	.22 kg (.48 lbs.)
Cavity	C10-4 (See BC Section for more details)

Ordering Information

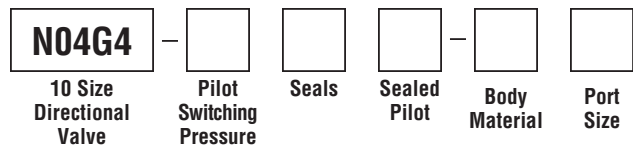

Code	Switching Pressure
10.0	10.0 Bar (145 PSI) Std.
15.0	15.0 Bar (218 PSI)

If no switching pressure is specified, valve will be supplied as N04G4-10.0N

Code	Body Material
Omit	Steel
A	Aluminum

Code	Seals / Kit No.
N	Nitrile, Buna-N / (SK30506N-1)
V	Fluorocarbon / (SK30506V-1)

Code	Port Size	Body Part No.
Omit	Cartridge Only	
6P	3/8" NTPF	(B10-4-*6P)
6T	SAE-6	(B10-4-*6T)
8T	SAE-8	(B10-4-*8T)
6B	3/8" BSPG	(B10-4-6B)†

* Add "A" for aluminum, omit for steel.
† Steel bodies only

Code	Sealed Pilot
Omit	If not required
S	Sealed Pilot



General Description

Pilot Operated Directional Valve, 3-Way External Pilot Vented to Atmosphere. Open Transition Feature.

Features

- High flow capacity
- Two switching pressures available
- Sealed pilot option available
- Hardened working parts for maximum durability
- All external parts zinc plated

Performance Curve

Pressure Drop vs. Flow (Through cartridge only)

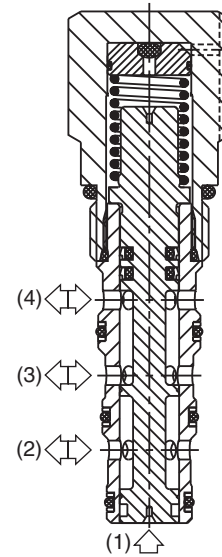
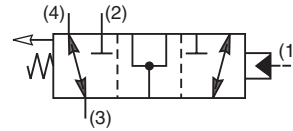
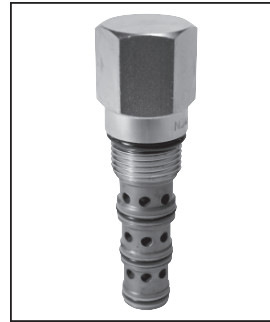
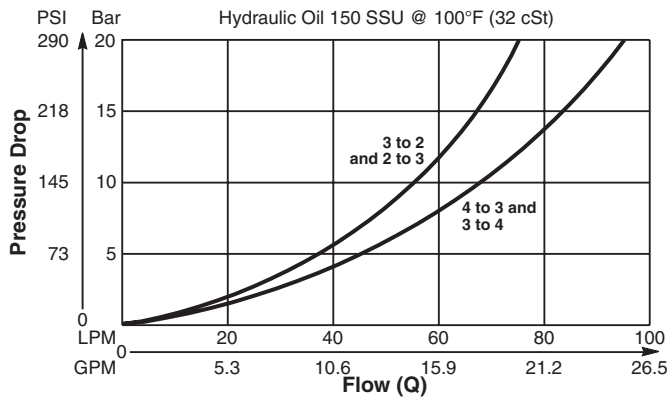

Dimensions Millimeters (Inches)

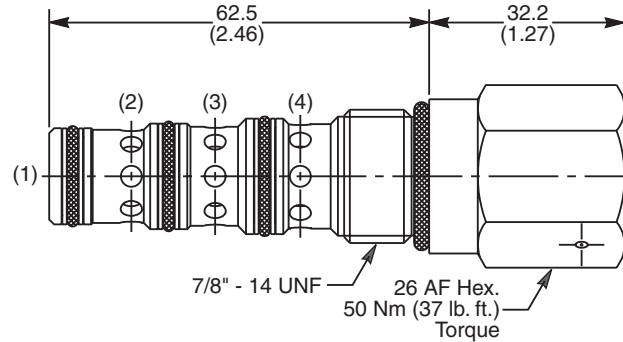

Specifications

Rated Flow	85 LPM (22.5 GPM)
Nominal Flow @ 7 Bar (100 PSI)	50 LPM (13 GPM)
Maximum Inlet Pressure	420 Bar (6000 PSI)
Pilot Switching Pressure	See ordering information
Cartridge Material	All parts steel. All operating parts hardened steel.
Operating Temp. Range/Seals	-40°C to +93.3°C (Nitrile, Buna-N) (-40°F to +200°F) -31.7°C to +121.1°C (Fluorocarbon) (-25°F to +250°F)
Fluid Compatibility/Viscosity	Mineral-based or synthetic with lubricating properties at viscosities of 45 to 2000 SSU (6 to 420 cSt)
Filtration	ISO code 16/13, SAE Class 4 or better
Approx. Weight	.22 kg (.48 lbs.)
Cavity	C10-4 (See BC Section for more details)

Ordering Information

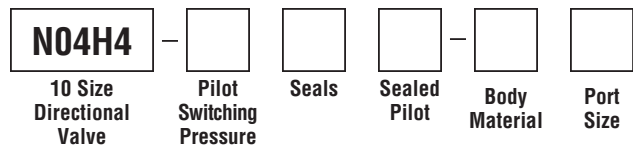

Code	Switching Pressure
10.0	10.0 Bar (145 PSI) Std.
15.0	15.0 Bar (218 PSI)

If no switching pressure is specified, valve will be supplied as N04H4-10.0N

Code	Seals / Kit No.
N	Nitrile, Buna-N / (SK30506N-1)
V	Fluorocarbon / (SK30506V-1)

Code	Sealed Pilot
Omit	If not required
S	Sealed Pilot

Code	Body Material
Omit	Steel
A	Aluminum

Code	Port Size	Body Part No.
Omit	Cartridge Only	
6P	3/8" NTPF	(B10-4-*6P)
6T	SAE-6	(B10-4-*6T)
8T	SAE-8	(B10-4-*8T)
6B	3/8" BSPG	(B10-4-6B)†

* Add "A" for aluminum, omit for steel.
 † Steel bodies only

Technical Information

- CV** Check Valves
- SH** Shuttle Valves
- LM** Load/Motor Controls
- FC** Flow Controls
- PC** Pressure Controls
- LE** Logic Elements
- DC** Directional Controls
- MV** Manual Valves
- SV** Solenoid Valves
- PV** Proportional Valves
- CE** Coils & Electronics
- BC** Bodies & Cavities
- TD** Technical Data

General Description

Pilot Operated Directional Valve, 3-Way, 2 Position, External Drain, Open Transition.

Features

- High flow capacity
- Used as high flow switching or metering element
- Range of spring settings available
- All external parts zinc plated

Performance Curve

Pressure Drop vs. Flow (Through cartridge only)

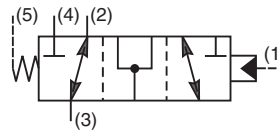
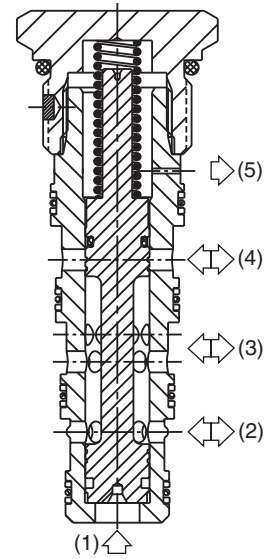
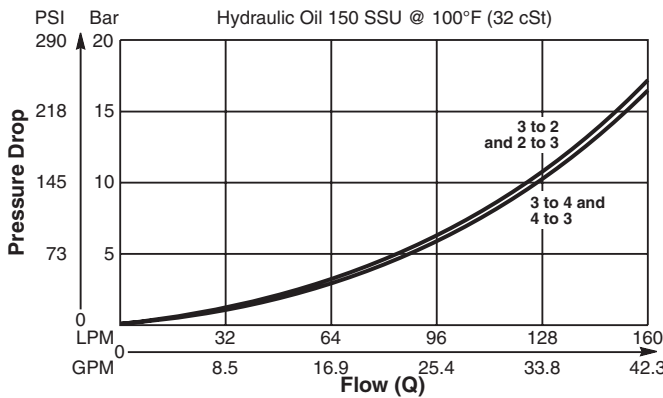

Dimensions Millimeters (Inches)

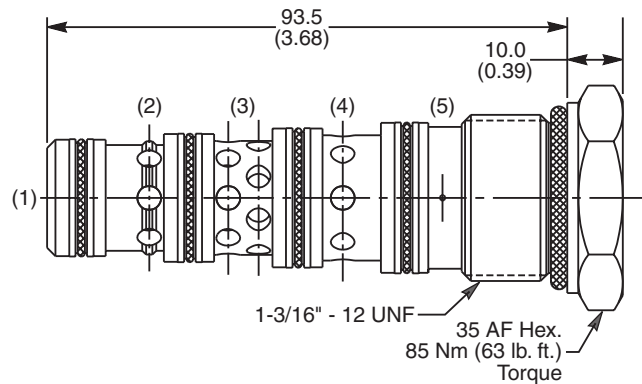

Specifications

Rated Flow	160 LPM (42.3 GPM)
Nominal Flow @ 7 Bar (100 PSI)	90 LPM (24 GPM)
Maximum Inlet Pressure	420 Bar (6000 PSI)
Pilot Switching Pressure	See ordering information
Cartridge Material	Steel operating parts, hardened steel spool.
Operating Temp. Range/Seals	-40°C to +93.3°C (Nitrile, Buna-N) (-40°F to +200°F) -31.7°C to +121.1°C (Fluorocarbon) (-25°F to +250°F)
Fluid Compatibility/Viscosity	Mineral-based or synthetic with lubricating properties at viscosities of 45 to 2000 SSU (6 to 420 cSt)
Filtration	ISO code 16/13, SAE Class 4 or better
Approx. Weight	.33 kg (.76 lbs.)
Cavity	5A (See BC Section for more details)

Ordering Information

N5A125 — Directional Valve (All Ports Open) Pilot Switching Pressure Seals

Code	Switching Pressure
0.0	0.0 Bar (0 PSI)
5.0	5.0 Bar (73 PSI)
6.9	6.9 Bar (100 PSI) Std.
10.0	10.0 Bar (145 PSI)
15.0	15.0 Bar (217 PSI)

If no switching pressure is specified, valve will be supplied as N5A125-6.9N

Code	Seals / Kit No.
N	Nitrile, Buna-N / (SK30103N-1)
V	Fluorocarbon / (SK30103V-1)

Order Bodies Separately

LB10 Line Body Porting Body Material

Code	Porting
314	3/4" BSP (main) 1/4" BSP (aux)
321	3/4" SAE (main) 1/4" SAE (aux)

Code	Body Material
A	Aluminum
S	Steel



General Description

Pilot Operated Directional Valve, 3-Way, 2 Position, External Drain, Open Transition.

Features

- High flow capacity
- Used as high flow switching or metering element
- Range of spring settings available
- All external parts zinc plated

Performance Curve

Pressure Drop vs. Flow (Through cartridge only)

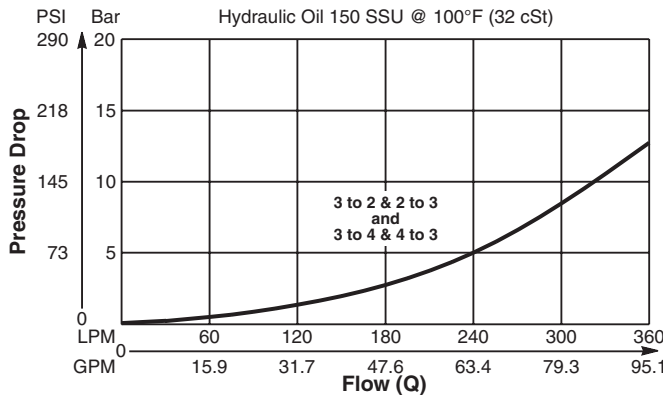

Specifications

Rated Flow	400 LPM (105 GPM)
Nominal Flow @ 7 Bar (100 PSI)	270 LPM (71 GPM)
Maximum Inlet Pressure	420 Bar (6000 PSI)
Pilot Switching Pressure	See ordering information
Cartridge Material	Steel operating parts, hardened steel spool.
Operating Temp. Range/Seals	-40°C to +93.3°C (Nitrile, Buna-N) (-40°F to +200°F) -31.7°C to +121.1°C (Fluorocarbon) (-25°F to +250°F)
Fluid Compatibility/Viscosity	Mineral-based or synthetic with lubricating properties at viscosities of 45 to 2000 SSU (6 to 420 cSt)
Filtration	ISO code 16/13, SAE Class 4 or better
Approx. Weight	1.00 kg (2.2 lbs.)
Cavity	100-1 (See BC Section for more details)

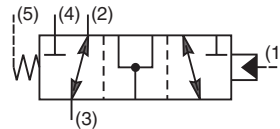
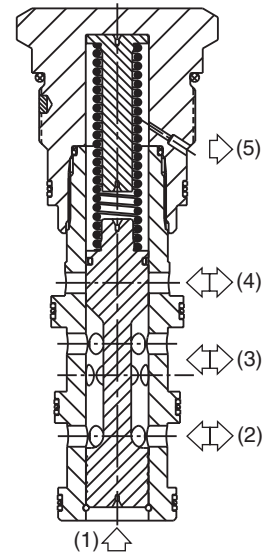

Dimensions Millimeters (Inches)

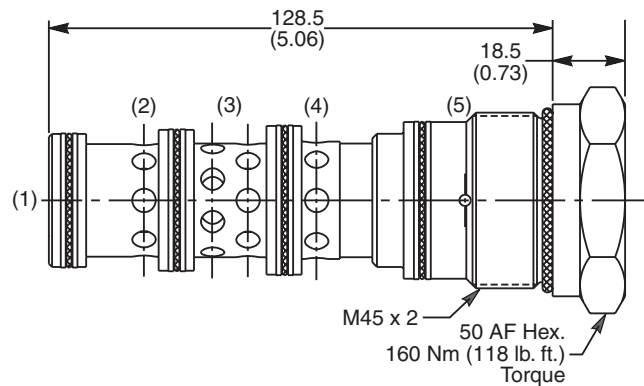

Ordering Information

N5A300 — Directional Valve (All Ports Open) Pilot Switching Pressure Seals

Code	Switching Pressure
3.0	3.0 Bar (44 PSI)
6.9	6.9 Bar (100 PSI) Std.
10.0	10.0 Bar (145 PSI)

If no switching pressure is specified, valve will be supplied as N5A300-6.9N

Code	Seals / Kit No.
N	Nitrile, Buna-N / (SK30065N-1)
V	Fluorocarbon / (SK30065V-1)

Order Bodies Separately

LB10 — Line Body Porting Body Material

Code	Porting
316	1-1/4" BSP (main) 3/8" BSP (aux)
317	1-1/4" SAE (main) 3/8" SAE (aux)

Code	Body Material
A	Aluminum
S	Steel

CV Check Valves

SH Shuttle Valves

LM Load/Motor Controls

FC Flow Controls

PC Pressure Controls

LE Logic Elements

DC Directional Controls

MV Manual Valves

SV Solenoid Valves

PV Proportional Valves

CE Coils & Electronics

BC Bodies & Cavities

TD Technical Data

Technical Information

- CV** Check Valves
- SH** Shuttle Valves
- LM** Load/Motor Controls
- FC** Flow Controls
- PC** Pressure Controls
- LE** Logic Elements
- DC** Directional Controls
- MV** Manual Valves
- SV** Solenoid Valves
- PV** Proportional Valves
- CE** Coils & Electronics
- BC** Bodies & Cavities
- TD** Technical Data

General Description

Pilot Operated Directional Valve, 3-Way, 2 Position, External Drain, Closed Transition.

Features

- High flow capacity
- Used as high flow switching or metering element
- Range of spring settings available
- All external parts zinc plated

Performance Curve

Pressure Drop vs. Flow (Through cartridge only)

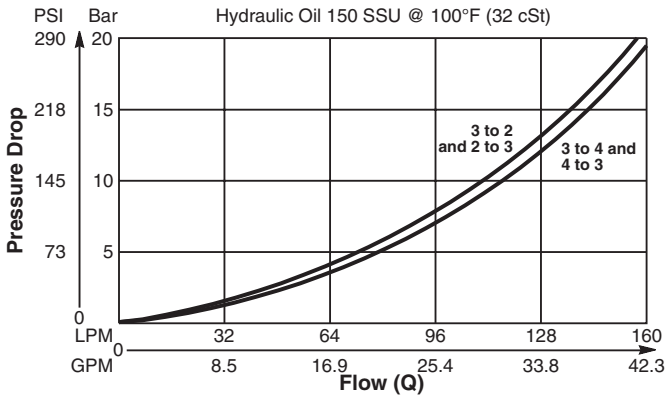

Specifications

Rated Flow	160 LPM (42.3 GPM)
Nominal Flow @ 7 Bar (100 PSI)	90 LPM (24 GPM)
Maximum Inlet Pressure	420 Bar (6000 PSI)
Pilot Switching Pressure	See ordering information
Cartridge Material	Steel operating parts, hardened steel spool.
Operating Temp. Range/Seals	-40°C to +93.3°C (Nitrile, Buna-N) (-40°F to +200°F) -31.7°C to +121.1°C (Fluorocarbon) (-25°F to +250°F)
Fluid Compatibility/Viscosity	Mineral-based or synthetic with lubricating properties at viscosities of 45 to 2000 SSU (6 to 420 cSt)
Filtration	ISO code 16/13, SAE Class 4 or better
Approx. Weight	.33 kg (.76 lbs.)
Cavity	5A (See BC Section for more details)

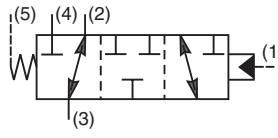
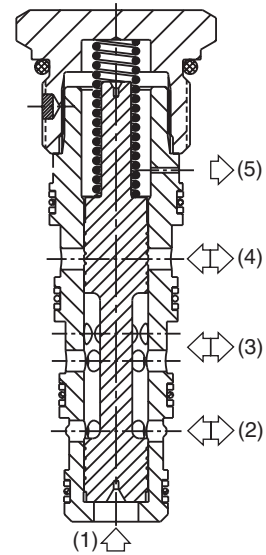

Dimensions Millimeters (Inches)

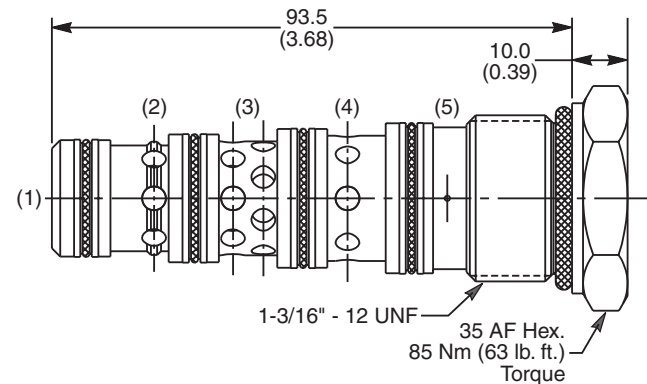

Ordering Information

N5B125 — Directional Valve (All Ports Closed) Pilot Switching Pressure Seals

Code	Switching Pressure
0.0	0.0 Bar (0 PSI)
5.0	5.0 Bar (73 PSI)
6.9	6.9 Bar (100 PSI) Std.
10.0	10.0 Bar (145 PSI)
15.0	15.0 Bar (217 PSI)

If no switching pressure is specified, valve will be supplied as N5B125-6.9N

Code	Seals / Kit No.
N	Nitrile, Buna-N / (SK30103N-1)
V	Fluorocarbon / (SK30103V-1)

Order Bodies Separately

LB10 Line Body Porting Body Material

Code	Porting
314	3/4" BSP (main) 1/4" BSP (aux)
321	3/4" SAE (main) 1/4" SAE (aux)

Code	Body Material
A	Aluminum
S	Steel



General Description

Pilot Operated Directional Valve, 3-Way, 2 Position, External Drain, Closed Transition.

Features

- High flow capacity
- Used as high flow switching or metering element
- Range of spring settings available
- All external parts zinc plated

Performance Curve

Pressure Drop vs. Flow (Through cartridge only)

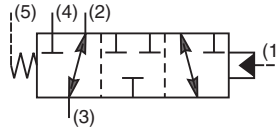
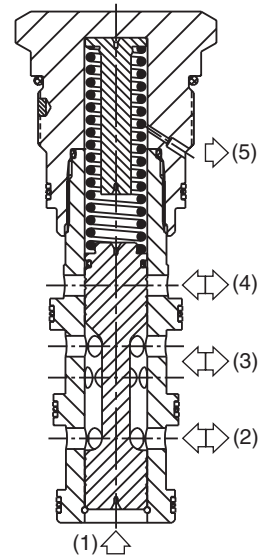
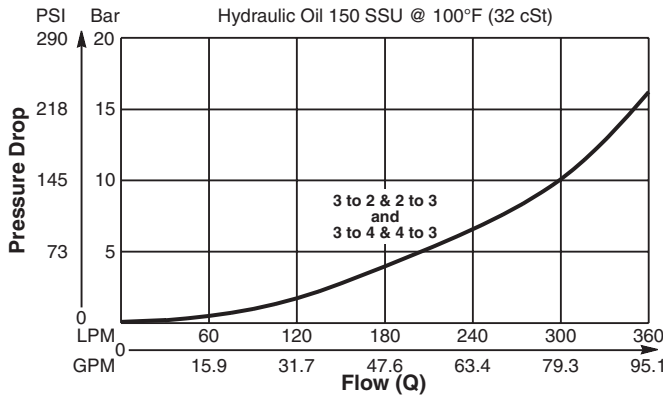

Dimensions Millimeters (Inches)

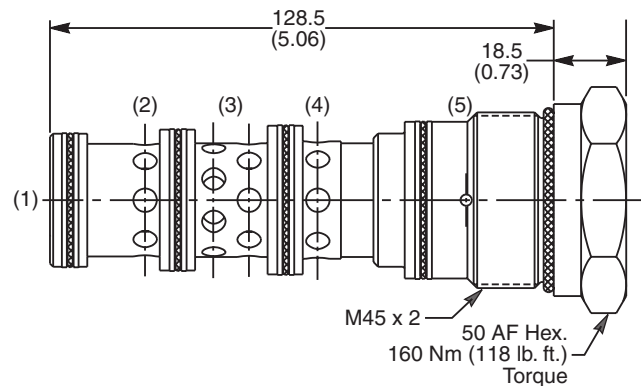

Specifications

Rated Flow	400 LPM (105 GPM)
Nominal Flow @ 7 Bar (100 PSI)	270 LPM (71 GPM)
Maximum Inlet Pressure	420 Bar (6000 PSI)
Pilot Switching Pressure	See ordering information
Cartridge Material	Steel operating parts, hardened steel spool.
Operating Temp. Range/Seals	-40°C to +93.3°C (Nitrile, Buna-N) (-40°F to +200°F) -31.7°C to +121.1°C (Fluorocarbon) (-25°F to +250°F)
Fluid Compatibility/Viscosity	Mineral-based or synthetic with lubricating properties at viscosities of 45 to 2000 SSU (6 to 420 cSt)
Filtration	ISO code 16/13, SAE Class 4 or better
Approx. Weight	1.00 kg (2.2 lbs.)
Cavity	100-1 (See BC Section for more details)

Ordering Information

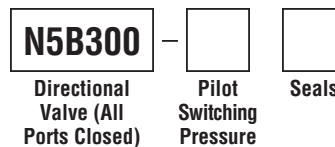

Code	Switching Pressure
3.0	3.0 Bar (44 PSI)
6.9	6.9 Bar (100 PSI) Std.
10.0	10.0 Bar (145 PSI)

If no switching pressure is specified, valve will be supplied as N5B300-6.9N

Code	Seals / Kit No.
N	Nitrile, Buna-N / (SK30065N-1)
V	Fluorocarbon / (SK30065V-1)

Order Bodies Separately



Code	Porting
316	1-1/4" BSP (main) 3/8" BSP (aux)
317	1-1/4" SAE (main) 3/8" SAE (aux)

Code	Body Material
A	Aluminum
S	Steel

- CV** Check Valves
- SH** Shuttle Valves
- LM** Load/Motor Controls
- FC** Flow Controls
- PC** Pressure Controls
- LE** Logic Elements
- DC** Directional Controls
- MV** Manual Valves
- SV** Solenoid Valves
- PV** Proportional Valves
- CE** Coils & Electronics
- BC** Bodies & Cavities
- TD** Technical Data

- CV** Check Valves
- SH** Shuttle Valves
- LM** Load/Motor Controls
- FC** Flow Controls
- PC** Pressure Controls
- LE** Logic Elements
- DC** Directional Controls
- MV** Manual Valves
- SV** Solenoid Valves
- PV** Proportional Valves
- CE** Coils & Electronics
- BC** Bodies & Cavities
- TD** Technical Data

General Description

Diverter Valve, 3-Way, 2 Position, External Drain, Normally Open.

Features

- High flow capacity
- Used as high flow switching or metering element
- Range of spring settings available
- Sealed pilot option available
- All external parts zinc plated

Performance Curve

Pressure Drop vs. Flow (Through cartridge only)

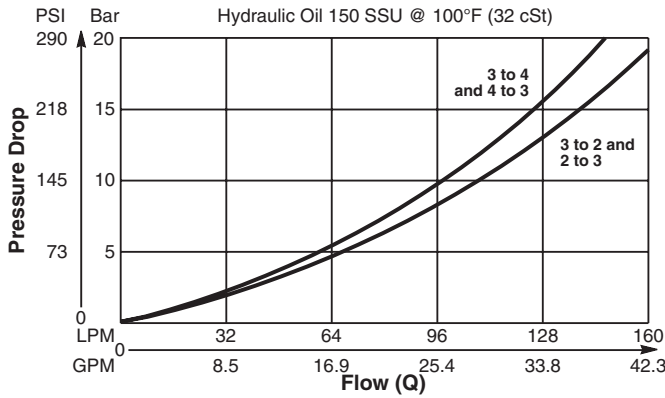

Specifications

Rated Flow	160 LPM (42.3 GPM)
Nominal Flow @ 7 Bar (100 PSI)	80 LPM (21 GPM)
Maximum Inlet Pressure	420 Bar (6000 PSI)
Pilot Switching Pressure	See ordering information
Cartridge Material	Steel operating parts, hardened steel spool.
Operating Temp. Range/Seals	-40°C to +93.3°C (Nitrile, Buna-N) (-40°F to +200°F) -31.7°C to +121.1°C (Fluorocarbon) (-25°F to +250°F)
Fluid Compatibility/Viscosity	Mineral-based or synthetic with lubricating properties at viscosities of 45 to 2000 SSU (6 to 420 cSt)
Filtration	ISO code 16/13, SAE Class 4 or better
Approx. Weight	.33 kg (.76 lbs.)
Cavity	5A (See BC Section for more details)

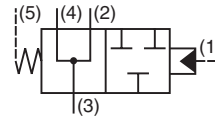
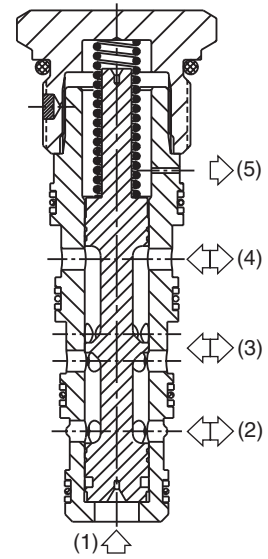

Dimensions

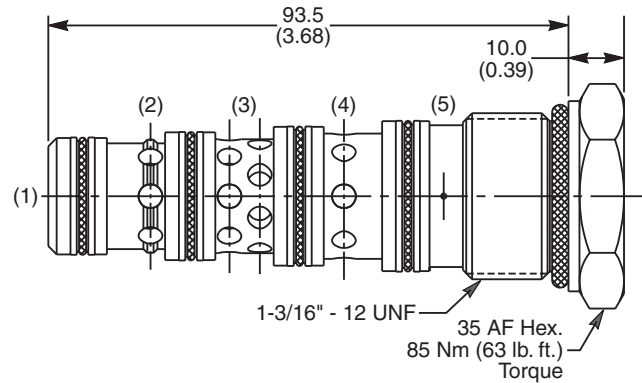

Ordering Information

N5C125 —

Diverter Valve (All Ports Open) Pilot Switching Pressure Seals

Code	Switching Pressure
0.0	0.0 Bar (0 PSI)
5.0	5.0 Bar (73 PSI)
6.9	6.9 Bar (100 PSI) Std.
10.0	10.0 Bar (145 PSI)
15.0	15.0 Bar (217 PSI)

If no switching pressure is specified, valve will be supplied as N5C125-6.9N

Code	Seals / Kit No.
N	Nitrile, Buna-N / (SK30103N-1)
V	Fluorocarbon / (SK30103V-1)

Order Bodies Separately

LB10

Line Body Porting Body Material

Code	Porting
314	3/4" BSP (main) 1/4" BSP (aux)
321	3/4" SAE (main) 1/4" SAE (aux)

Code	Body Material
A	Aluminum
S	Steel

General Description

Diverter Valve, 3-Way, 2 Position, External Drain, Normally Open.

Features

- High flow capacity
- Used as high flow switching or metering element
- Range of spring settings available
- All external parts zinc plated

Performance Curve

Pressure Drop vs. Flow (Through cartridge only)

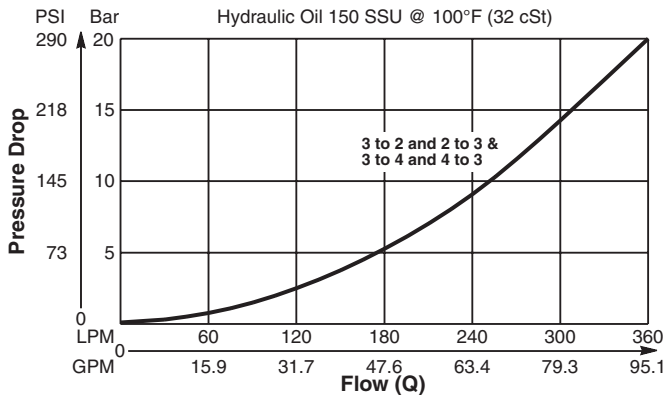

Specifications

Rated Flow	400 LPM (105 GPM)
Nominal Flow @ 7 Bar (100 PSI)	3 to 2 - 130 LPM (34 GPM) 3 to 4 - 240 LPM (63 GPM)
Maximum Inlet Pressure	420 Bar (6000 PSI)
Pilot Switching Pressure	See ordering information
Cartridge Material	Steel operating parts, hardened steel spool.
Operating Temp. Range/Seals	-40°C to +93.3°C (Nitrile, Buna-N) (-40°F to +200°F) -31.7°C to +121.1°C (Fluorocarbon) (-25°F to +250°F)
Fluid Compatibility/Viscosity	Mineral-based or synthetic with lubricating properties at viscosities of 45 to 2000 SSU (6 to 420 cSt)
Filtration	ISO code 16/13, SAE Class 4 or better
Approx. Weight	1.00 kg (2.2 lbs.)
Cavity	100-1 (See BC Section for more details)

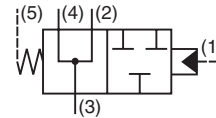
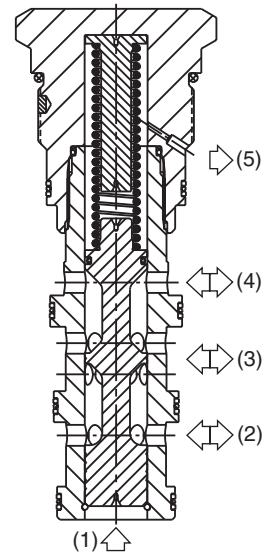

Dimensions Millimeters (Inches)

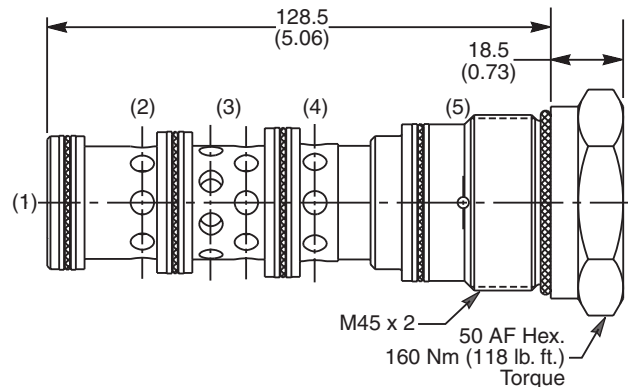

Ordering Information

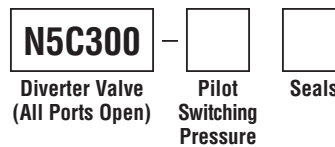

Code	Switching Pressure
3.0	3.0 Bar (44 PSI)
6.9	6.9 Bar (100 PSI) Std.
10.0	10.0 Bar (145 PSI)

If no switching pressure is specified, valve will be supplied as N5C300-6.9N

Code	Seals / Kit No.
N	Nitrile, Buna-N / (SK30065N-1)
V	Fluorocarbon / (SK30065V-1)

Order Bodies Separately



Code	Porting
316	1-1/4" BSP (main) 3/8" BSP (aux)
317	1-1/4" SAE (main) 3/8" SAE (aux)

Code	Body Material
A	Aluminum
S	Steel

CV Check Valves

SH Shuttle Valves

LM Load/Motor Controls

FC Flow Controls

PC Pressure Controls

LE Logic Elements

DC Directional Controls

MV Manual Valves

SV Solenoid Valves

PV Proportional Valves

CE Coils & Electronics

BC Bodies & Cavities

TD Technical Data

- CV** Check Valves
- SH** Shuttle Valves
- LM** Load/Motor Controls
- FC** Flow Controls
- PC** Pressure Controls
- LE** Logic Elements
- DC** Directional Controls
- MV** Manual Valves
- SV** Solenoid Valves
- PV** Proportional Valves
- CE** Coils & Electronics
- BC** Bodies & Cavities
- TD** Technical Data

General Description

Diverter Valve, 3-Way, 2 Position, External Drain, Normally Closed.

Features

- High flow capacity
- Used as high flow switching or metering element
- Range of spring settings available
- Sealed pilot option available
- All external parts zinc plated

Performance Curve

Pressure Drop vs. Flow (Through cartridge only)

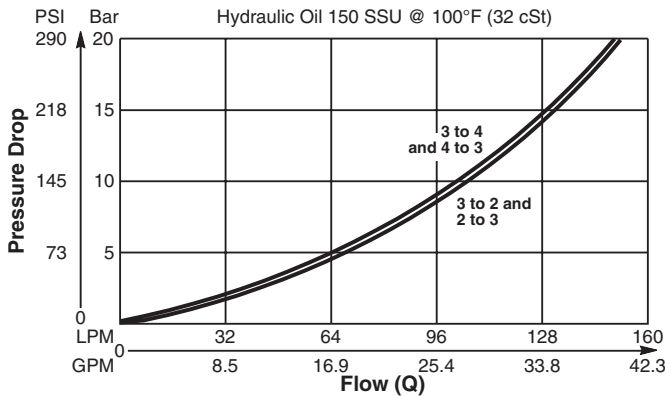

Specifications

Rated Flow	160 LPM (42.3 GPM)
Nominal Flow @ 7 Bar (100 PSI)	80 LPM (21 GPM)
Maximum Inlet Pressure	420 Bar (6000 PSI)
Pilot Switching Pressure	See ordering information
Cartridge Material	Steel operating parts, hardened steel spool.
Operating Temp. Range/Seals	-40°C to +93.3°C (Nitrile, Buna-N) (-40°F to +200°F) -31.7°C to +121.1°C (Fluorocarbon) (-25°F to +250°F)
Fluid Compatibility/Viscosity	Mineral-based or synthetic with lubricating properties at viscosities of 45 to 2000 SSU (6 to 420 cSt)
Filtration	ISO code 16/13, SAE Class 4 or better
Approx. Weight	.33 kg (.76 lbs.)
Cavity	5A (See BC Section for more details)

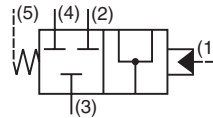
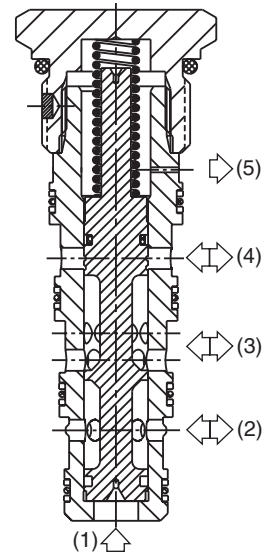

Dimensions

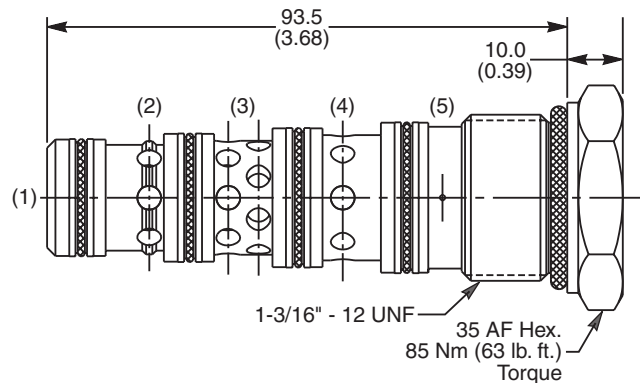

Ordering Information

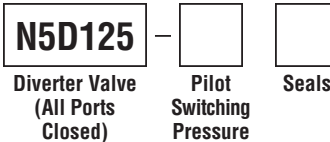

Code	Switching Pressure
0.0	0.0 Bar (0 PSI)
5.0	5.0 Bar (73 PSI)
6.9	6.9 Bar (100 PSI) Std.
10.0	10.0 Bar (145 PSI)
15.0	15.0 Bar (217 PSI)

If no switching pressure is specified, valve will be supplied as N5D125-6.9N

Code	Seals / Kit No.
N	Nitrile, Buna-N / (SK30103N-1)
V	Fluorocarbon / (SK30103V-1)

Order Bodies Separately



Code	Porting
314	3/4" BSP (main) 1/4" BSP (aux)
321	3/4" SAE (main) 1/4" SAE (aux)

Code	Body Material
A	Aluminum
S	Steel

General Description

Diverter Valve, 3-Way, 2 Position, External Drain, Normally Closed.

Features

- High flow capacity
- Used as high flow switching or metering element
- Range of spring settings available
- All external parts zinc plated

Performance Curve

Pressure Drop vs. Flow (Through cartridge only)

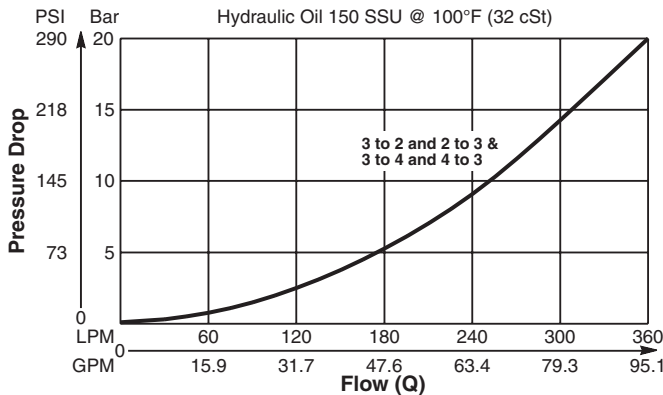

Specifications

Rated Flow	400 LPM (105 GPM)
Nominal Flow @ 7 Bar (100 PSI)	3 to 2 - 200 LPM (53 GPM) 3 to 4 - 200 LPM (53 GPM)
Maximum Inlet Pressure	420 Bar (6000 PSI)
Pilot Switching Pressure	See ordering information
Cartridge Material	Steel operating parts, hardened steel spool.
Operating Temp. Range/Seals	-40°C to +93.3°C (Nitrile, Buna-N) (-40°F to +200°F) -31.7°C to +121.1°C (Fluorocarbon) (-25°F to +250°F)
Fluid Compatibility/Viscosity	Mineral-based or synthetic with lubricating properties at viscosities of 45 to 2000 SSU (6 to 420 cSt)
Filtration	ISO code 16/13, SAE Class 4 or better
Approx. Weight	1.00 kg (2.2 lbs.)
Cavity	100-1 (See BC Section for more details)

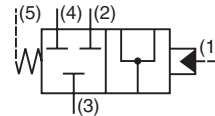
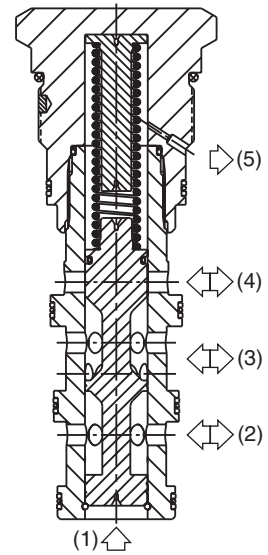

Dimensions Millimeters (Inches)

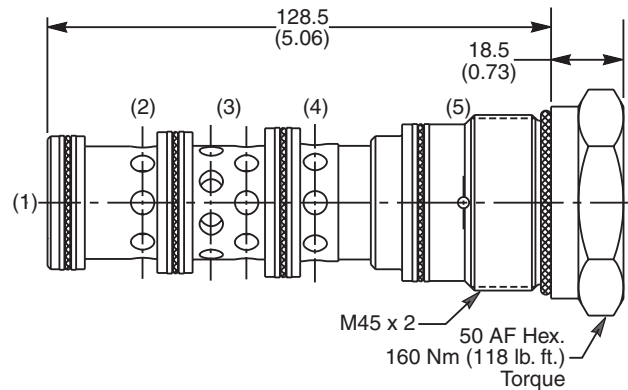

Ordering Information

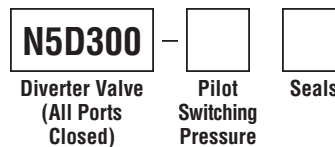

Code	Switching Pressure
3.0	3.0 Bar (44 PSI)
6.9	6.9 Bar (100 PSI) Std.
10.0	10.0 Bar (145 PSI)

If no switching pressure is specified, valve will be supplied as N5D300-6.9N

Code	Seals / Kit No.
N	Nitrile, Buna-N / (SK30065N-1)
V	Fluorocarbon / (SK30065V-1)

Order Bodies Separately



Code	Porting
316	1-1/4" BSP (main) 3/8" BSP (aux)
317	1-1/4" SAE (main) 3/8" SAE (aux)

Code	Body Material
A	Aluminum
S	Steel

- CV** Check Valves
- SH** Shuttle Valves
- LM** Load/Motor Controls
- FC** Flow Controls
- PC** Pressure Controls
- LE** Logic Elements
- DC** Directional Controls
- MV** Manual Valves
- SV** Solenoid Valves
- PV** Proportional Valves
- CE** Coils & Electronics
- BC** Bodies & Cavities
- TD** Technical Data