

	SERIES	CAVITY	DESCRIPTION	FLOW LPM/GPM	PRESSURE BAR/PSI	PAGE NO.	
	NEEDLE VALVES						
		J02A2	C08-2	Needle Valve, Cartridge Type	45/12	420/6000	FC5-FC6
	☆	NVH081	C08-2	Needle Valve, Cartridge Type	38/10	380/5500	FC7-FC8
	☆	NVH101	C10-2	Needle Valve, Cartridge Type	60/16	380/5500	FC9-FC10
		J06A2	C16-2	Needle Valve, Cartridge Type	225/60	420/6000	FC11-FC12
	J02B2	C08-2	Needle Valve with Reverse Check, 2 to 1 Free Flow	30/8	420/6000	FC13-FC14	
		FV101	C10-2	Needle Valve with Reverse Check, 1 to 2 Free Flow	45/12	210/3000	FC15-FC16
		FV102	C10-2	Needle Valve with Reverse Check, 1 to 2 Free Flow	23/6	210/3000	FC15-FC16
	PRESSURE COMPENSATED FLOW CONTROLS						
		J02E2	C08-2	Restrictive Flow Control, Adjustable	20/5.3	420/6000	FC17-FC18
		FR101	C10-2	Restrictive Flow Control, Tuneable	26/7	245/3500	FC19-FC20
		J04E2	C10-2	Restrictive Flow Control, Adjustable	40/10	420/6000	FC21-FC22
	J04C2	C10-2	Restrictive Flow Control, Adjustable	40/10	420/6000	FC23-FC24	
		FA101	C10-2	Restrictive Flow Control, Reverse Check, Adjustable	21/5.5	210/3000	FC25-FC26
		FC101	C10-2	Restrictive Flow Control, Reverse Check, Tuneable	56/15	210/3000	FC27-FC28
	PRESSURE COMPENSATED PRIORITY FLOW CONTROLS						
		J02D3	C08-3	Priority Type, with Bypass	15/4	420/6000	FC29-FC30
		FP101	C10-3	Priority Type, with Bypass	56/15	245/3500	FC31-FC32
		J04D3	C10-3	Priority Type, with Bypass	45/12	420/6000	FC33-FC34
		J1A125	3A	Priority Type, with Bypass	90/24	350/5000	FC35-FC36
	PRESSURE COMPENSATORS						
		FCR101	C10-3	Restrictive Type, Press. Compensators	38/10	245/3500	FC37
	FCR161	C16-3	Restrictive Type, Press. Compensators	150/40	245/3500	FC38	
<i>Note: Also see R04C3 on page DC1.</i>							
	PRIORITY PRESSURE COMPENSATORS						
		FCP101	C10-4	Priority Type, with Bypass	56/15	245/3500	FC39
	FCPH121	C12-4	Priority Type, with Bypass	95/25	380/5500	FC41-FC42	
	FLOW DIVIDERS/COMBINERS						
		FDC101	C10-4	Flow Divider/Combiner	45/12	245/3500	FC43-FC44
		L04A3	C10-4	Flow Divider/Combiner	60/16	420/6000	FC45-FC46
		L06A3	C16-4	Flow Divider/Combiner	180/47	420/6000	FC47-FC48
	L1A300	91-1	Flow Divider/Combiner	320/85	350/5000	FC49-FC50	

☆ Denotes New Winner's Circle Product Line.

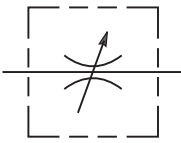
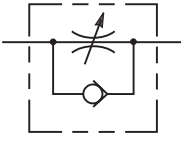
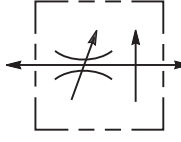
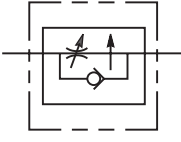
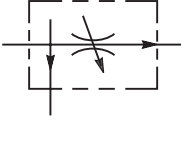
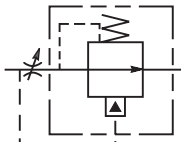
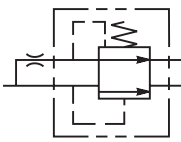
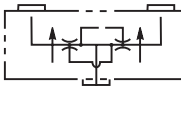

CV
Check Valves

SH
Shuttle Valves

LM
Load/Motor Controls

FC
Flow Controls

PC
Pressure Controls

LE
Logic Elements

DC
Directional Controls

MV
Manual Valves

SV
Solenoid Valves

PV
Proportional Valves

CE
Coils & Electronics

BC
Bodies & Cavities

TD
Technical Data

- CV Check Valves
- SH Shuttle Valves
- LM Load/Motor Controls
- FC Flow Controls
- PC Pressure Controls
- LE Logic Elements
- DC Directional Controls
- MV Manual Valves
- SV Solenoid Valves
- PV Proportional Valves
- CE Coils & Electronics
- BC Bodies & Cavities
- TD Technical Data

INTRODUCTION

This technical tips section is designed to help familiarize you with the Parker line of Flow Control Valves. In this section we present common options available as well as a brief synopsis of the operation and applications of the various product offered in this section. The intent of this section is to help you in selecting the best products for your application.

COMMON OPTIONS

As you will see, Parker offers a variety of Flow Control products. As such, some of the options mentioned below may not be available on all valve models. Consult the model coding and dimensions of each valve for specifics. Here are some of the common options available.

Adjustment Types: Parker offers four primary types of adjustments for most of the flow control products. Samples of these types are shown below. Please note all options may not be available for all valves. Consult the individual catalog pages for more details.

Screw Adjustment - Valve can be adjusted with an allen wrench. Lock nut included to maintain desired setting after adjustment. This is the most common adjustment option available on most Parker products.

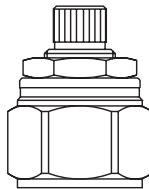

Knob Adjustment - An aluminum knob is added to the standard screw adjustment. A lock knob is provided to help maintain the desired setting after adjustment. Parker offers knob conversion kits for most flow control valves. For kit numbers consult the individual valve pages.

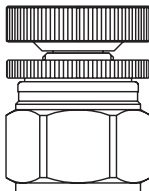

Fixed Style - In most cases, the Fixed Style product is a screw adjustable product with a steel collet threaded over the adjustment. These valves are preset at the factory. Should the valve need to be adjusted, the star washer and aluminum plate can be removed from the top of the assembly exposing the adjustment.

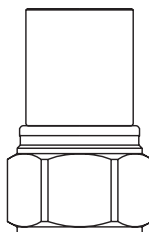
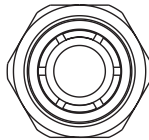

Tamper Resistant - The tamper resistant option is a screw adjustable valve with a steel cap installed to conceal the adjustment. The cap is designed so the internal edges clamp into the groove of the valve adapter. Once the cap is installed, it cannot be removed without damaging the cap and the valve. When a valve is ordered with the tamper resistant option, it will be preset at the factory, and the cap will be included in a separate plastic bag to allow for fine tuning at the customer site. Parker offers tamper resistant cap conversion kits for most flow control valves. For kit numbers consult the individual valve pages.

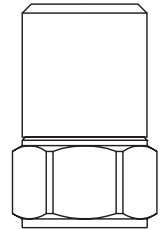

Seals: The Winner's Circle products feature a standard 4301 Polyurethane "D"-Ring. The "D"-Ring eliminates the need for backup rings. The majority of the products are available in Nitrile or Fluorocarbon Seals. You should match the seal compatibility to the temperature and fluid being used in your application.

Fine Meter Options: Fine meter needles are offered on some needle valve series. When this option is specified, the standard needle is replaced by a slotted needle. The slotted needle restricts substantially more flow giving you finer control in the small flow ranges. Obviously, the maximum flow capacity of the needle valve is decreased with the fine meter option.

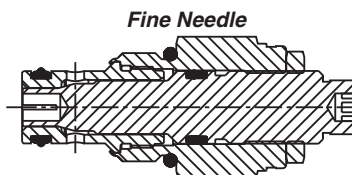
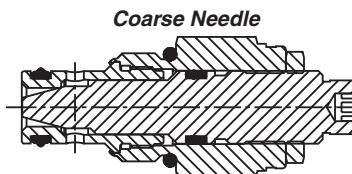

PRODUCT TYPES / APPLICATIONS

Needle Valve

Needle valves provide uncompensated adjustable flow control of a desired function. They are ideal for applications where general control of hydraulic flow is needed, like in a bleed off circuit.

When used with a compensator spool, a pressure compensated system can be obtained.

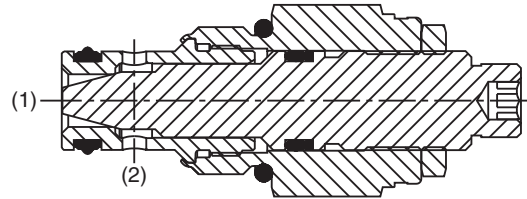
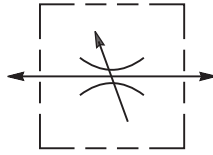

OPERATION - The valve acts as a fixed orifice in a hydraulic circuit. The effective size of the orifice increases as the tapered needle is opened. Shutoff is provided when fully closed. While a needle valve will meter flow regardless of the flow path, flow from port 2 to 1 is preferred. When you flow in the reverse direction (1 to 2), pressure forces work on the nose of the needle in an effort to drive it off of its seat. As such, all leakage conditions found in the catalog are based on flow from side to nose (port 2 to port 1). In addition, the adjustment will be harder to turn due to the added force.

Needle with a Reverse Check

Needle valves with reverse check functions are sometimes also referred to as flow control valves. As the name implies, these valves provide uncompensated adjustable speed control in one direction and allow free flow in the opposite direction. When used with a compensator spool, a pressure compensated system can be obtained.

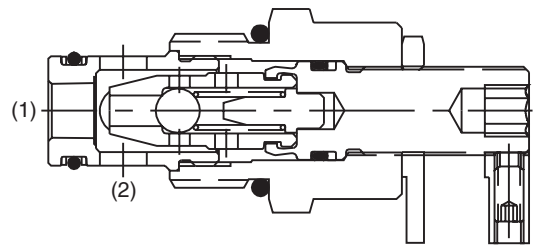
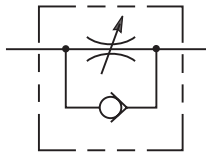

OPERATION - With flow entering the side of the cartridge (port 2), the needle acts as a fixed orifice. The effective size of this orifice is increased as the needle is opened controlling the output flow to port 1. With flow entering the nose (port 1), the check ball inside the needle is unseated allowing free flow to port 2.

P.C. Flow Regulator

Pressure compensated flow regulators maintain a regulated flow regardless of changes in load or inlet pressure. They are commonly used to accurately control an actuator function. They can be used in meter-in or meter-out applications.

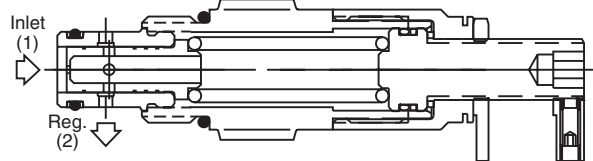
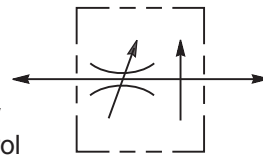

OPERATION - The valve consists of a control orifice within a normally open, spring biased compensator spool. Flow through the control orifice produces a pressure drop across the compensator spool. When inlet flow exceeds the flow setting of the valve, the force produced by the pressure differential across the spool exceeds the spring force and shifts the compensator spool to throttle or restrict flow; thus maintaining consistent flow through the valve. In the reverse direction, flow is metered, but not pressure compensated.

CV
Check Valves
SH
Shuttle Valves
LM
Load/Motor Controls
FC
Flow Controls
PC
Pressure Controls
LE
Logic Elements
DC
Directional Controls
MV
Manual Valves
SV
Solenoid Valves
PV
Proportional Valves
CE
Coils & Electronics
BC
Bodies & Cavities
TD
Technical Data

- CV Check Valves
- SH Shuttle Valves
- LM Load/Motor Controls
- FC Flow Controls
- PC Pressure Controls
- LE Logic Elements
- DC Directional Controls
- MV Manual Valves
- SV Solenoid Valves
- PV Proportional Valves
- CE Coils & Electronics
- BC Bodies & Cavities
- TD Technical Data

P.C. Flow Control

Pressure compensated flow controls are pressure compensated regulators with a reverse flow check valve. They provide constant regulated flow in the one direction regardless of changes in load pressure. Flow in the reverse direction is non-regulated, free flow. They can be used in meter-in or meter-out applications.

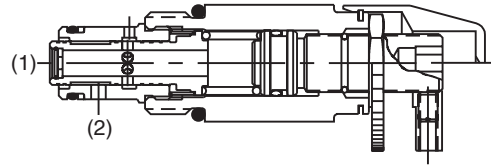
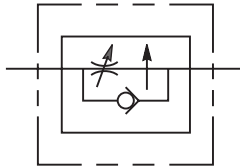

Adjustable Flow Controls

Most adjustable pressure compensated flow controls have a limited adjustment range. You will see in our catalog that we use the term “tuneable” for the FR101 and FC101 valves. This means they are only adjustable within a pre-set range. The FA101, J02E2, J04E2 and J04C2 are fully adjustable. Keep this adjustment capability in mind when you select a flow control.

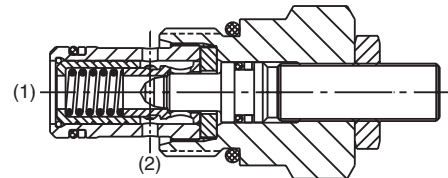
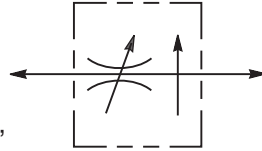

OPERATION - When flow enters the nose (port 1) of the cartridge, it passes through a control orifice. This control orifice creates a pressure differential across the regulating spool. As the inlet flow increases, the pressure differential across the regulating spool increases, allowing the regulating spool to overcome its spring force and begin to shift. As it shifts, it throttles to maintain a constant flow. When used in conjunction with a fixed displacement pump, a relief valve between pump and valve is needed. Full flow is allowed in the reverse direction (port 2 to 1).

Priority Style P.C. Flow Regulator

Priority style pressure compensator regulators maintain constant priority flow to one leg of the circuit regardless of changes in load or inlet pressure. Once this priority flow requirement is satisfied, the excess flow is diverted and can be used in another leg of the circuit. These valves are usually used in meter-in applications.

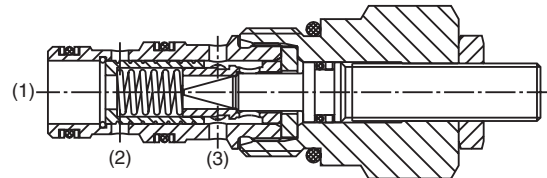
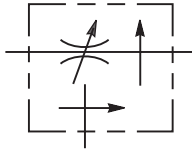

OPERATION - The valve consists of a control orifice within a spring biased compensator spool. The priority port is normally open while the bypass port is normally closed. As flow enters the inlet of the cartridge and passes through the control orifice, a pressure differential is created across the compensator spool. When the inlet flow exceeds the setting of the valve, the force produced by this pressure differential exceeds the spring force and shifts the compensator spool; opening up the bypass port, and bypassing the excess flow. If load pressure at the bypass port is greater than the load pressure at the priority port, the compensator spool will further shift restricting the priority flow to that of the valve setting. **Caution:** If the priority line is blocked so that no flow can pass through the control orifice, the compensator spool will shift, blocking the bypass port and allowing inlet pressure to go to full system relief pressure. These valves do not provide a pressure relieving function, so it is common to place an external relief valve downstream of port 3 to prevent a no flow condition.

Compensator Valves

Compensator valves are used to provide pressure compensated control across an external fixed or adjustable orifice. Parker offers both the restrictive type of compensator and a priority style.

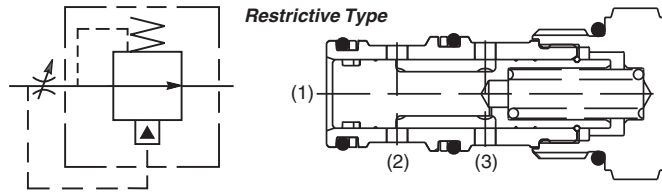

OPERATION - Restrictive Type:

Inlet flow (upstream of the orifice) is split with one portion going to the compensator port inlet (port 1), the other portion passes through the orifice to the supply port (port 3). As pressure drop across the orifice reaches the selected compensator pressure drop, the higher pressure (pre-orifice) at port 1 starts to shift the compensator spool into throttling position. The valve works to maintain a constant pressure drop across the orifice.

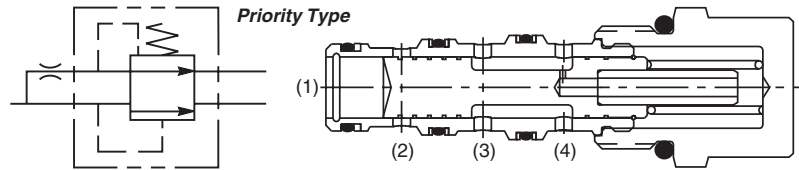

Priority Type: Flow through the external orifice into the supply port (port 4) produces a pressure drop across the compensator spool. When the inlet pressure exceeds the initial setting of the valve, the force produced by the pressure differential across the spool exceeds the spring force and shifts the compensator spool to throttle or restrict the flow, thus maintaining constant flow through the priority port (port 3). The excess flow is bypassed to port 2. Regulated port flow must be maintained for bypass flow to continue.

Flow Divider / Combiner

Flow divider / combiner valves are used to proportion the flow from a single source into two actuators. In the reverse mode, the valve takes the flow from the two sources and combines it into one flow.

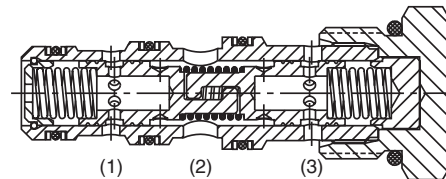
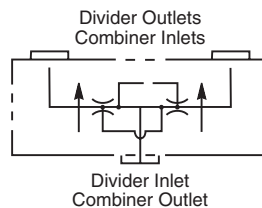

When attempting to synchronize two cylinders

with a flow/divider combiner valve, please consider that the flow accuracy is +10%.

A crossover relief can be used to help re-synchronize the cylinders by bottoming them out after several cycles.

OPERATION - When flow enters the divider inlet port, it will pass through orifices in each of the interconnected spools. The flow passing through the orifices creates a pressure drop which pulls the two spools away from each other. The flow then passes to the two divider outlet ports. The division of flow (i.e. 50-50, 60-40, 66-33, etc.) is determined by the orifice sizes in the two spools. When flow is being combined, it enters the valve through two combiner inlets. The pressure drop across the orifices pulls the two spools together. The combined flow then passes through the combiner outlet.

- CV
- Check Valves
- SH
- Shuttle Valves
- LM
- Load/Motor Controls
- FC
- Flow Controls
- PC
- Pressure Controls
- LE
- Logic Elements
- DC
- Directional Controls
- MV
- Manual Valves
- SV
- Solenoid Valves
- PV
- Proportional Valves
- CE
- Coils & Electronics
- BC
- Bodies & Cavities
- TD
- Technical Data

- CV** Check Valves
- SH** Shuttle Valves
- LM** Load/Motor Controls
- FC** Flow Controls
- PC** Pressure Controls
- LE** Logic Elements
- DC** Directional Controls
- MV** Manual Valves
- SV** Solenoid Valves
- PV** Proportional Valves
- CE** Coils & Electronics
- BC** Bodies & Cavities
- TD** Technical Data

General Description

Cartridge Style Needle Valve. For additional information see Technical Tips on pages FC1-FC4.

Features

- Shuts off to a very low leakage level
- High flow capacity from a small cavity
- Good adjustment sensitivity - ideal for fine control
- Good contamination tolerant
- Adjustable and tamperproof versions available
- All external parts zinc plated

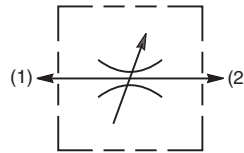
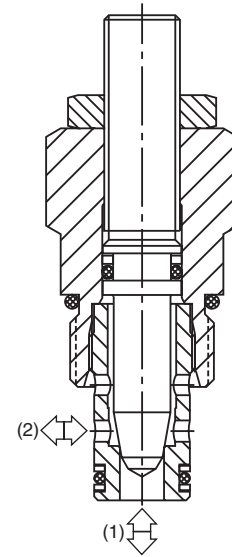

Specifications

Rated Flow	45 LPM (12 GPM)
Maximum Inlet Pressure	420 Bar (6000 PSI)
Cartridge Material	All parts steel. All operating parts hardened steel.
Operating Temp. Range/Seals	-40°C to +93.3°C (Nitrile) (-40°F to +200°F) -31.7°C to +121.1°C (Fluorocarbon) (-25°F to +250°F)
Fluid Compatibility/ Viscosity	Mineral-based or synthetic with lubricating properties at viscosities of 45 to 2000 SSU (6 to 420 cSt)
Filtration	ISO Code 16/13, SAE Class 4 or better
Approx. Weight	.11 kg (.24 lbs.)
Cavity	C08-2 (See BC Section for more details)
Form Tool	Rougher None Finisher NFT08-2F

Performance Curves (Through cartridge only)

Low Pressure Drop vs. Flow 1 to 2 & 2 to 1

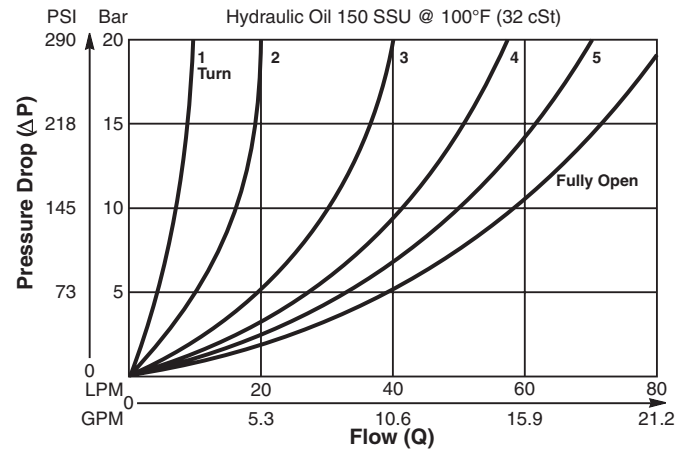

High Pressure Drop vs. Flow 1 to 2 & 2 to 1

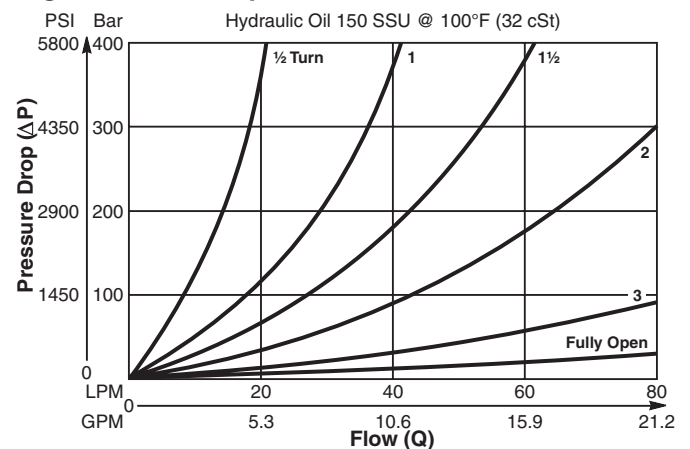

Dimensions Millimeters (Inches)

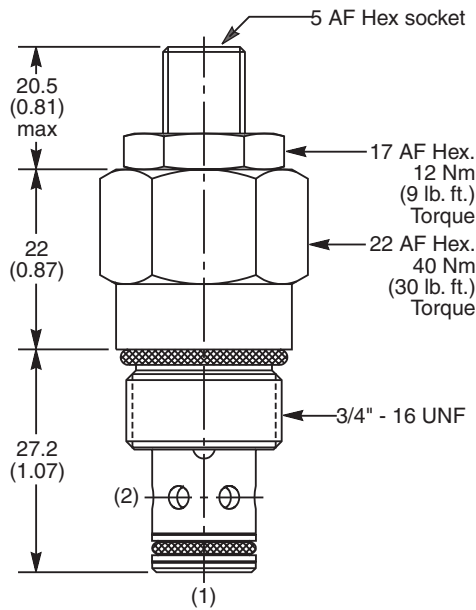

Ordering Information

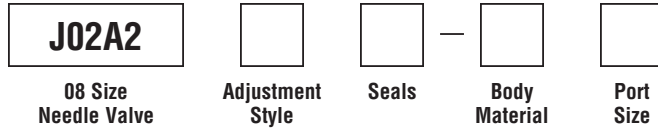

Code	Adjustment Style
Z	Screw Adjust (Std.)
W	Knob Adjust
T	Tamper Resistant Cap (TC1130)

Code	Seals / Kit. No.
N	Nitrile, Buna-N (Std.) / (SK30500N-1)
V	Fluorocarbon / (SK30500V-1)

Code	Body Material
Omit	Steel
A	Aluminum

Code	Port Size	Body Part No.
Omit	Cartridge Only	
4P	1/4" NPTF	(B08-2-*4P)
6P	3/8" NPTF	(B08-2-*6P)
4T	SAE-4	(B08-2-*4T)
6T	SAE-6	(B08-2-*6T)
6B	3/8" BSPG	(B08-2-*6B)

* Add "A" for aluminum, omit for steel.

- CV** Check Valves
- SH** Shuttle Valves
- LM** Load/Motor Controls
- FC** Flow Controls
- PC** Pressure Controls
- LE** Logic Elements
- DC** Directional Controls
- MV** Manual Valves
- SV** Solenoid Valves
- PV** Proportional Valves
- CE** Coils & Electronics
- BC** Bodies & Cavities
- TD** Technical Data

General Description

Cartridge Style Needle Valve.
 For additional information see
 Technical Tips on pages FC1-FC4.



Features

- Hardened, precision ground parts for durability
- Compact size for reduced space requirements
- Fine adjustment needle option available for precise adjustment
- Polyurethane "D"-Ring eliminates backup rings and prevents hydrolysis
- Valve meters flow in either direction, but (2 to 1) is the preferred direction for lowest leakage at shut off
- All external parts zinc plated

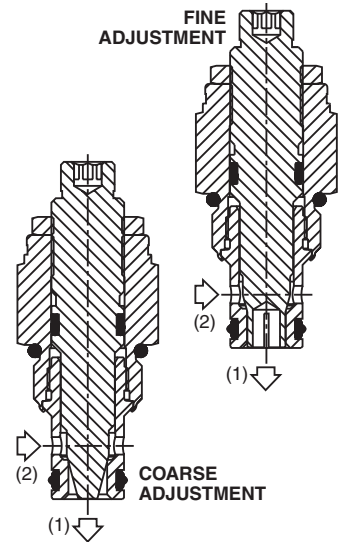
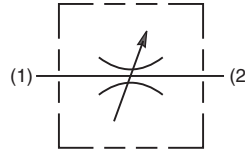

Specifications

Rated Flow	Fixed 37.9 LPM (10 GPM) Adjusted
Maximum Inlet Pressure	380 Bar (5500 PSI)
Cartridge Material	All parts steel. All operating parts hardened steel.
Operating Temp. Range/Seals	-45°C to +93.3°C ("D"-Ring) (-50°F to +200°F) -31.7°C to +121.1°C (Fluorocarbon) (-25°F to +250°F)
Fluid Compatibility/ Viscosity	Mineral-based or synthetic with lubricating properties at viscosities of 45 to 2000 SSU (6 to 420 cSt)
Filtration	ISO Code 16/13, SAE Class 4 or better
Approx. Weight	.10 kg (.20 lbs.)
Cavity	No. C08-2 (See BC Section for more details)
Form Tool	Rougher None Finisher NFT08-2F

Performance Curves

Flow vs. Inlet Pressure (Through cartridge only)

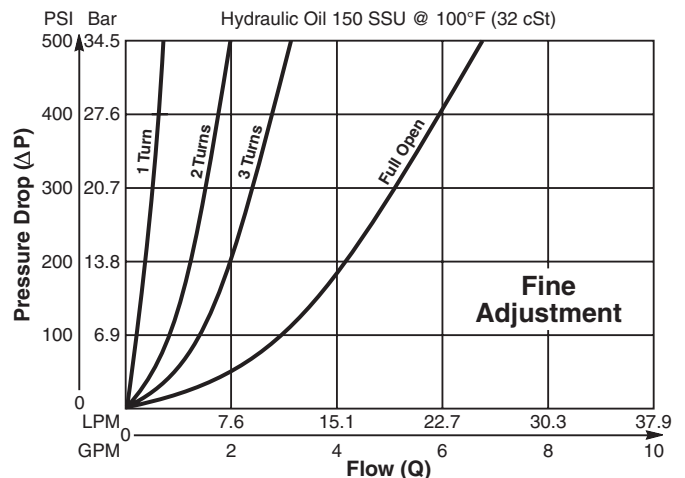
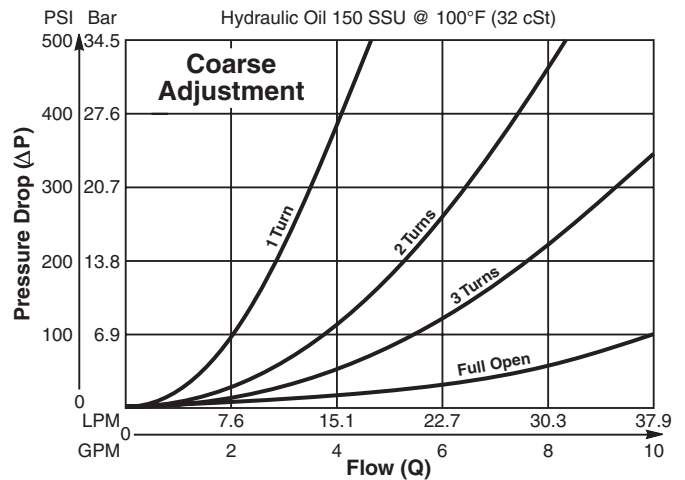

Dimensions Millimeters (Inches)

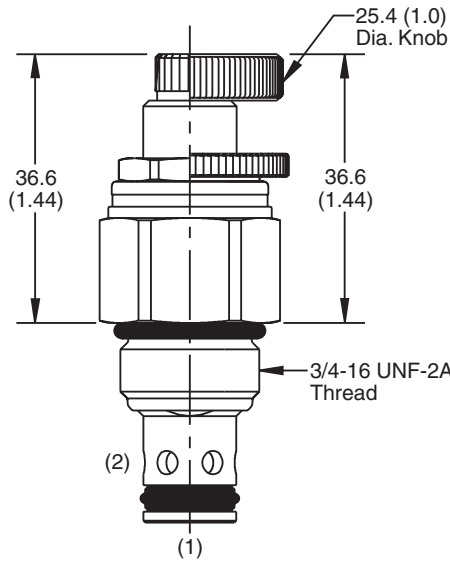

Screw/Knob Version

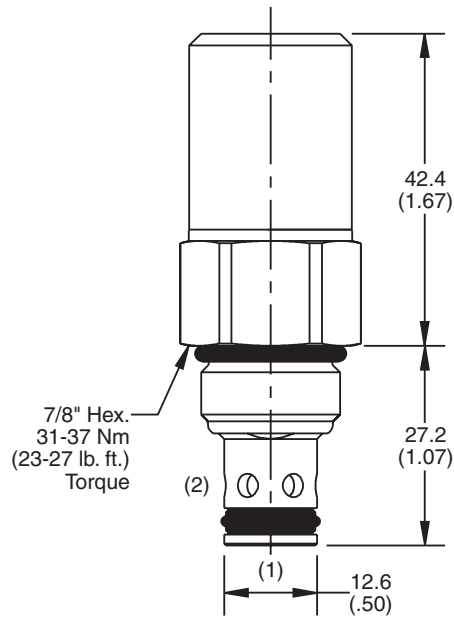

Tamper Resistant Version

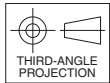

Ordering Information



Code	Flow Needle
Omit	Coarse
F	Fine

Code	Seals / Kit. No.
Omit	"D"-Ring / (SK08-2)
N	Nitrile / (SK08-2N)
V	Fluorocarbon / (SK08-2V)

Code	Body Material
Omit	Steel
A	Aluminum

Code	Port Size	Body Part No.
Omit	Cartridge Only	
4P	1/4" NPTF	(B08-2-*4P)
6P	3/8" NPTF	(B08-2-*6P)
4T	SAE-4	(B08-2-*4T)
6T	SAE-6	(B08-2-*6T)
6B	3/8" BSPG	(B08-2-*6B)

* Add "A" for aluminum, omit for steel.

Code	Adjustment Style
K	Knob Adjust (717784-10)
S	Screw Adjust
T	Tamper Resistant Cap (717943)

- CV** Check Valves
- SH** Shuttle Valves
- LM** Load/Motor Controls
- FC** Flow Controls
- PC** Pressure Controls
- LE** Logic Elements
- DC** Directional Controls
- MV** Manual Valves
- SV** Solenoid Valves
- PV** Proportional Valves
- CE** Coils & Electronics
- BC** Bodies & Cavities
- TD** Technical Data

- CV** Check Valves
- SH** Shuttle Valves
- LM** Load/Motor Controls
- FC** Flow Controls
- PC** Pressure Controls
- LE** Logic Elements
- DC** Directional Controls
- MV** Manual Valves
- SV** Solenoid Valves
- PV** Proportional Valves
- CE** Coils & Electronics
- BC** Bodies & Cavities
- TD** Technical Data

General Description

Cartridge Style Needle Valve. For additional information see Technical Tips on pages FC1-FC4.



Features

- Hardened, precision ground parts for durability
- Compact size for reduced space requirements
- Fine adjustment needle option available for precise adjustment
- Polyurethane “D”-Ring eliminates backup rings and prevents hydrolysis
- Valve meters flow in either direction, but (2 to 1) is the preferred direction for lowest leakage at shut off
- All external parts zinc plated

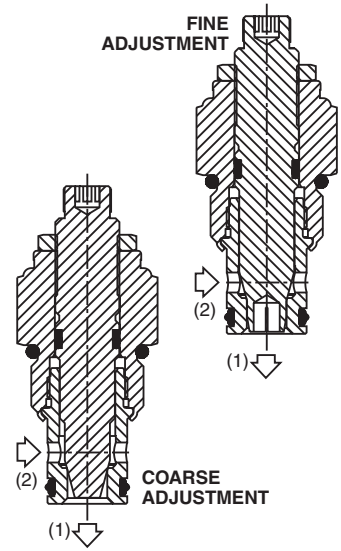
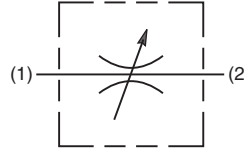
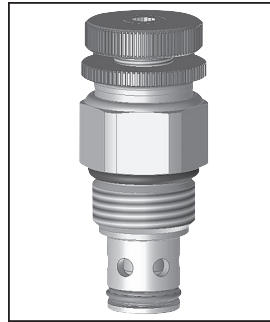

Specifications

Rated Flow	Fixed 60 LPM (16 GPM) Adjusted 60 LPM (16 GPM)
Maximum Inlet Pressure	380 Bar (5500 PSI)
Cartridge Material	All parts steel. All operating parts hardened steel.
Operating Temp. Range/Seals	-45°C to +93.3°C (“D”-Ring) (-50°F to +200°F) -31.7°C to +121.1°C (Fluorocarbon) (-25°F to +250°F)
Fluid Compatibility/ Viscosity	Mineral-based or synthetic with lubricating properties at viscosities of 45 to 2000 SSU (6 to 420 cSt)
Filtration	ISO Code 16/13, SAE Class 4 or better
Approx. Weight	.18 kg (0.4 lbs.)
Cavity	C10-2 (See BC Section for more details)
Form Tool	Rougher None Finisher NFT10-2F

Performance Curves

Flow vs. Inlet Pressure (Through cartridge only)

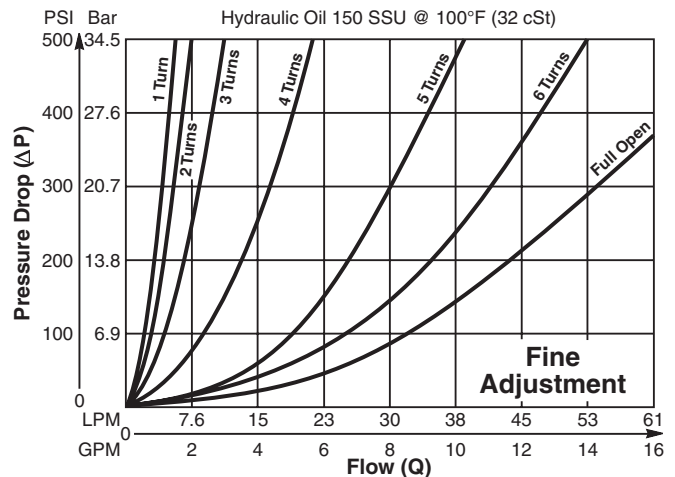
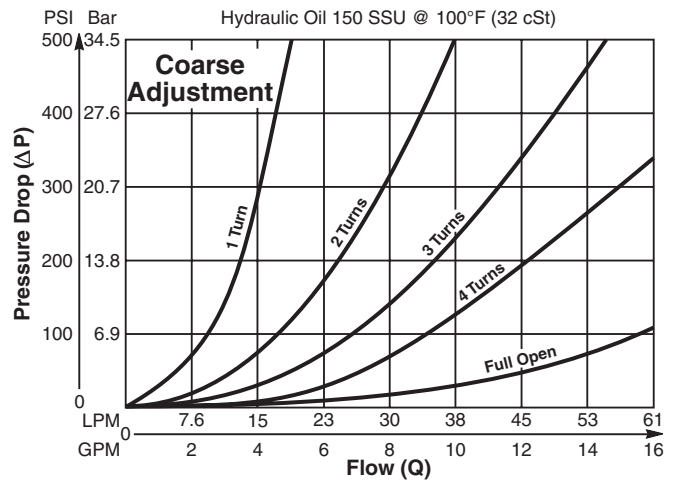

Dimensions Millimeters (Inches)

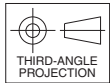
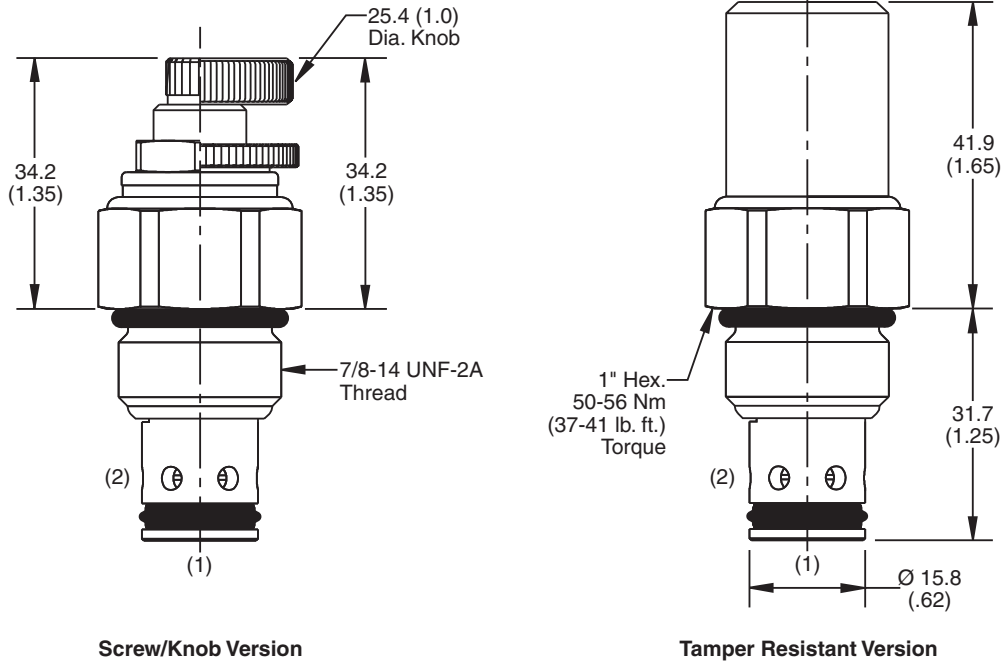

Ordering Information



Code	Flow Needle
Omit	Coarse
F	Fine

Code	Seals / Kit. No.
Omit	"D"-Ring / (SK10-2)
N	Nitrile / (SK10-2N)
V	Fluorocarbon / (SK10-2V)

Code	Body Material
Omit	Steel
A	Aluminum

Code	Port Size	Body Part No.
Omit	Cartridge Only	
4P	1/4" NPTF	(B10-2-*4P)
6P	3/8" NPTF	(B10-2-*6P)
8P	1/2" NPTF	(B10-2-*8P)
6T	SAE-6	(B10-2-*6T)
8T	SAE-8	(B10-2-*8T)
T8T	SAE-8	(B10-2-T8T)†
6B	3/8" BSPG	(B10-2-*6B)

Code	Adjustment Style
K	Knob Adjust (717784-10)
S	Screw Adjust
T	Tamper Resistant Cap (717943)

* Add "A" for aluminum, omit for steel.
 † Steel body only.

- CV**
Check Valves
- SH**
Shuttle Valves
- LM**
Load/Motor Controls
- FC**
Flow Controls
- PC**
Pressure Controls
- LE**
Logic Elements
- DC**
Directional Controls
- MV**
Manual Valves
- SV**
Solenoid Valves
- PV**
Proportional Valves
- CE**
Coils & Electronics
- BC**
Bodies & Cavities
- TD**
Technical Data

- CV** Check Valves
- SH** Shuttle Valves
- LM** Load/Motor Controls
- FC** Flow Controls
- PC** Pressure Controls
- LE** Logic Elements
- DC** Directional Controls
- MV** Manual Valves
- SV** Solenoid Valves
- PV** Proportional Valves
- CE** Coils & Electronics
- BC** Bodies & Cavities
- TD** Technical Data

General Description

Cartridge Style Needle Valve. For additional information see Technical Tips on pages FC1-FC4.

Features

- Shuts off to a very low leakage level
- High flow capacity
- Good adjustment sensitivity - ideal for fine control
- Good contamination tolerant
- Adjustable and tamperproof versions available
- All external parts zinc plated

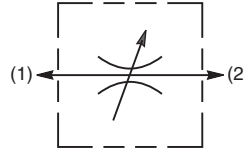
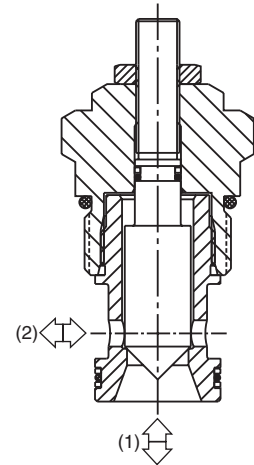
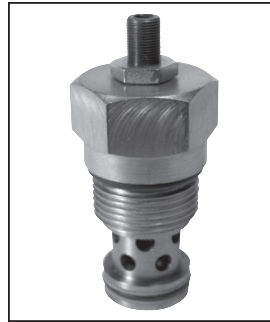

Specifications

Rated Flow	225 LPM (60 GPM)
Maximum Inlet Pressure	420 Bar (6000 PSI)
Cartridge Material	All parts steel. All operating parts hardened steel.
Operating Temp. Range/Seals	-40°C to +93.3°C (Nitrile) (-40°F to +200°F) -31.7°C to +121.1°C (Fluorocarbon) (-25°F to +250°F)
Fluid Compatibility/Viscosity	Mineral-based or synthetic with lubricating properties at viscosities of 45 to 2000 SSU (6 to 420 cSt)
Filtration	ISO Code 16/13, SAE Class 4 or better
Approx. Weight	.38 kg (.84 lbs.)
Cavity	C16-2 (See BC Section for more details)
Form Tool	Rougher None Finisher NFT16-2F

Performance Curves (Through cartridge only)

Low Pressure Drop vs. Flow 1 to 2 & 2 to 1

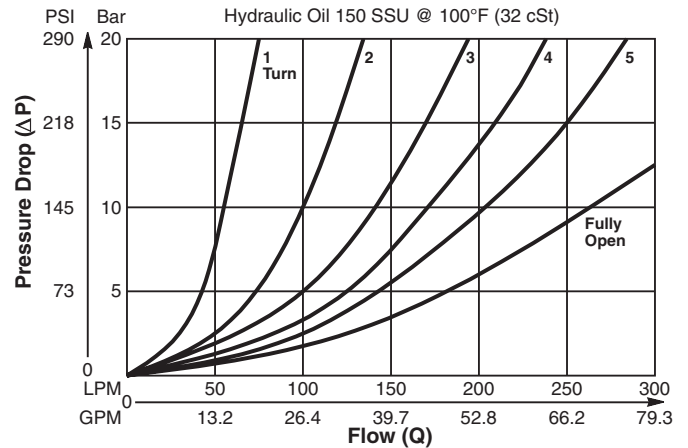

High Pressure Drop vs. Flow 1 to 2 & 2 to 1

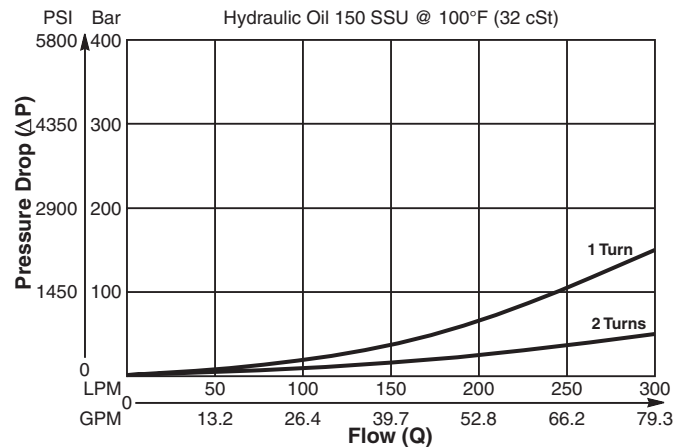

Dimensions Millimeters (Inches)

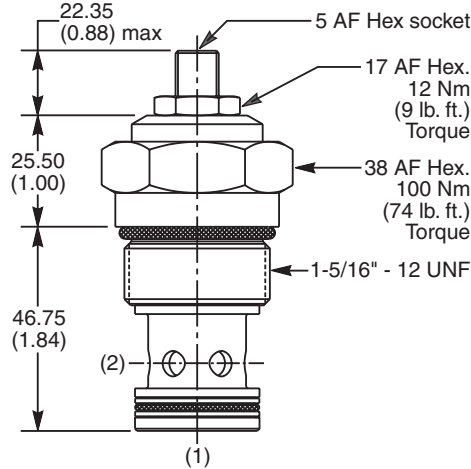

Ordering Information

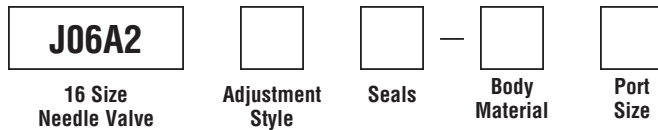

Code	Adjustment Style
Z	Screw Adjust (Std.)
W	Knob Adjust
T	Tamper Resistant Cap (TC1130)

Code	Seals / Kit. No.
N	Nitrile, Buna-N (Std.) / (SK30507N-1)
V	Fluorocarbon / (SK30507V-1)

Code	Body Material
Omit	Steel
A	Aluminum

Code	Port Size	Body Part No.
Omit	Cartridge Only	
12P	3/4" NPTF	(B16-2-*12P)
16P	1" NPTF	(B16-2-*16P)
8T	SAE-8	(B16-2-*8T)
12T	SAE-12	(B16-2-*12T)
16T	SAE-16	(B16-2-*16T)
12B	3/4" BSPG	(B16-2-12B)†
16B	1" BSPG	(B16-2-*16B)

* Add "A" for aluminum, omit for steel.
 † Steel body only.

- CV** Check Valves
- SH** Shuttle Valves
- LM** Load/Motor Controls
- FC** Flow Controls
- PC** Pressure Controls
- LE** Logic Elements
- DC** Directional Controls
- MV** Manual Valves
- SV** Solenoid Valves
- PV** Proportional Valves
- CE** Coils & Electronics
- BC** Bodies & Cavities
- TD** Technical Data

General Description

Poppet Type Needle Valve with Reverse Flow Check. For additional information see Technical Tips on pages FC1-FC4.

Features

- Shuts off to a very low leakage level
- Good adjustment sensitivity - ideal for fine control
- Good contamination tolerant
- Adjustable and tamperproof versions available
- All external parts zinc plated

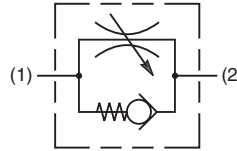
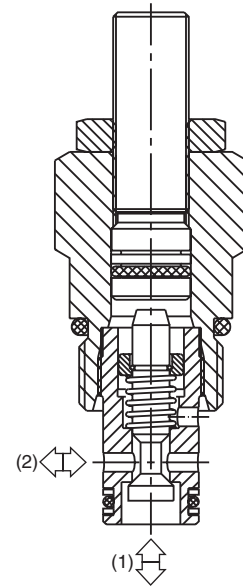
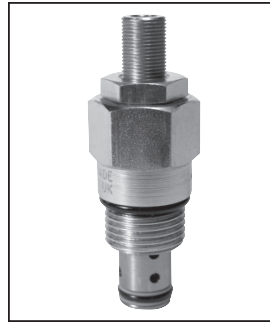

Specifications

Rated Flow	30 LPM (8 GPM)
Maximum Inlet Pressure	420 Bar (6000 PSI)
Cartridge Material	All parts steel. All operating parts hardened steel.
Operating Temp. Range/Seals	-40°C to +93.3°C (Nitrile) (-40°F to +200°F) -31.7°C to +121.1°C (Fluorocarbon) (-25°F to +250°F)
Fluid Compatibility/ Viscosity	Mineral-based or synthetic with lubricating properties at viscosities of 45 to 2000 SSU (6 to 420 cSt)
Filtration	ISO Code 16/13, SAE Class 4 or better
Approx. Weight	.11 kg (.24 lbs.)
Cavity	C08-2 (See BC Section for more details)
Form Tool	Rougher Finisher None None NFT08-2F

Performance Curves (Through cartridge only)

Low Pressure Drop vs. Flow 1 to 2 & 2 to 1

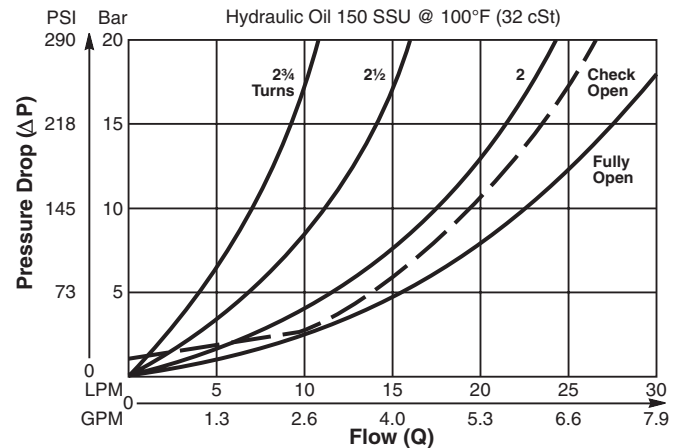

High Pressure Drop vs. Flow 1 to 2

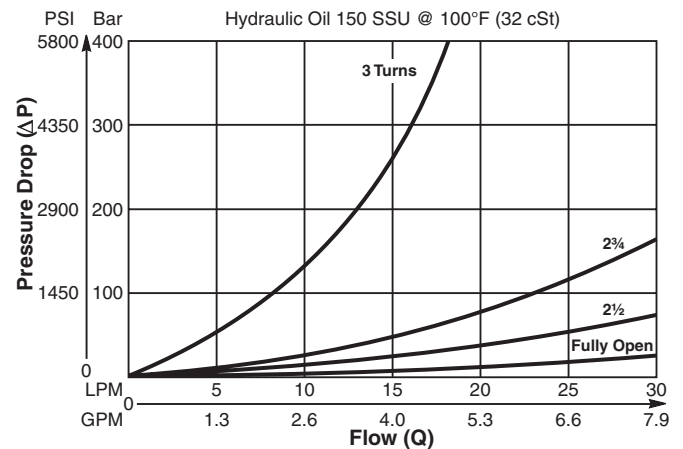

Dimensions Millimeters (Inches)

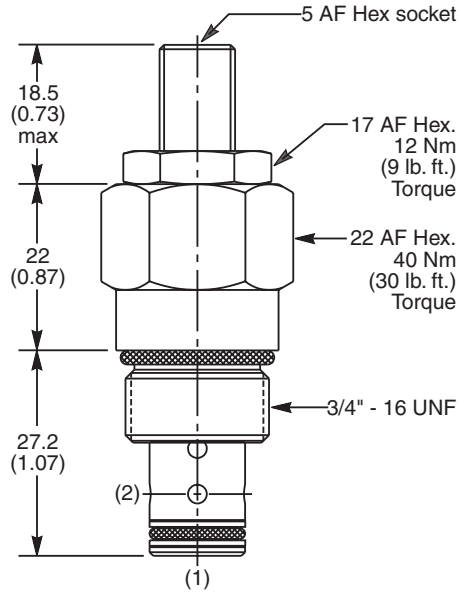

Ordering Information

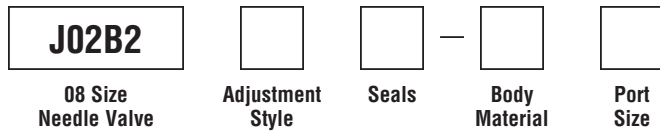

Code	Adjustment Style
Z	Screw Adjust (Std.)
W	Knob Adjust
T	Tamper Resistant Cap (TC1130)

Code	Seals / Kit. No.
N	Nitrile, Buna-N (Std.) / (SK30500N-1)
V	Fluorocarbon / (SK30500V-1)

Code	Body Material
Omit	Steel
A	Aluminum

Code	Port Size	Body Part No.
Omit	Cartridge Only	
4P	1/4" NPTF	(B08-2-*4P)
6P	3/8" NPTF	(B08-2-*6P)
4T	SAE-4	(B08-2-*4T)
6T	SAE-6	(B08-2-*6T)
6B	3/8" BSPG	(B08-2-*6B)

* Add "A" for aluminum, omit for steel.

Technical Information

- CV Check Valves
- SH Shuttle Valves
- LM Load/Motor Controls
- FC Flow Controls
- PC Pressure Controls
- LE Logic Elements
- DC Directional Controls
- MV Manual Valves
- SV Solenoid Valves
- PV Proportional Valves
- CE Coils & Electronics
- BC Bodies & Cavities
- TD Technical Data

General Description

Needle Valve with a Reverse Check. Also known as a Flow Control Valve. For additional information see Technical Tips on pages FC1-FC4.

Features

- Hardened, precision ground parts for durability
- Compact size for reduced space requirements
- Fine thread needle option available for precise adjustment
- All external parts zinc plated

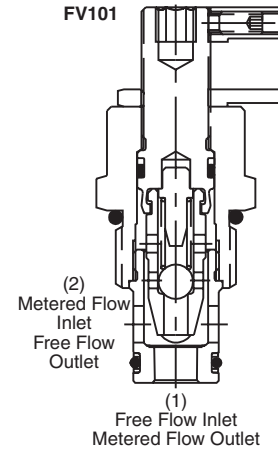
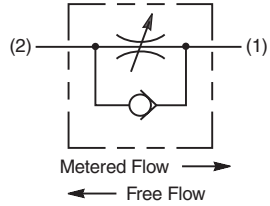

Specifications

Rated Flow	FV101 45 LPM (12 GPM) FV102 23 LPM (6 GPM)
Maximum Inlet Pressure	210 Bar (3000 PSI)
Cartridge Material	All parts steel. All operating parts hardened steel.
Operating Temp. Range/Seals	-40°C to +93.3°C (Nitrile) (-40°F to +200°F) -31.7°C to +121.1°C (Fluorocarbon) (-25°F to +250°F)
Fluid Compatibility/ Viscosity	Mineral-based or synthetic with lubricating properties at viscosities of 45 to 2000 SSU (6 to 420 cSt)
Filtration	ISO Code 16/13, SAE Class 4 or better
Approx. Weight	.23 kg (0.5 lbs.)
Cavity	C10-2 (See BC Section for more details)
Form Tool	Rougher None Finisher NFT10-2F

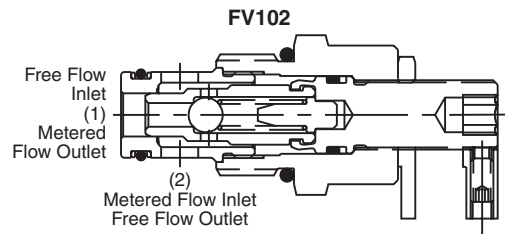

Dimensions Millimeters (Inches)

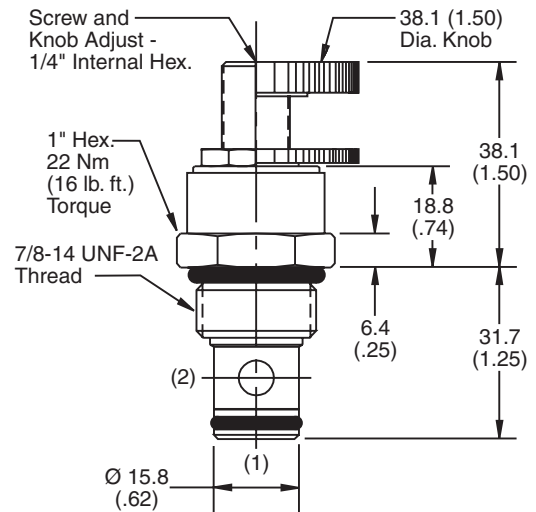

Performance Curves

Metered Flow vs. Pressure Drop (Through cartridge only)

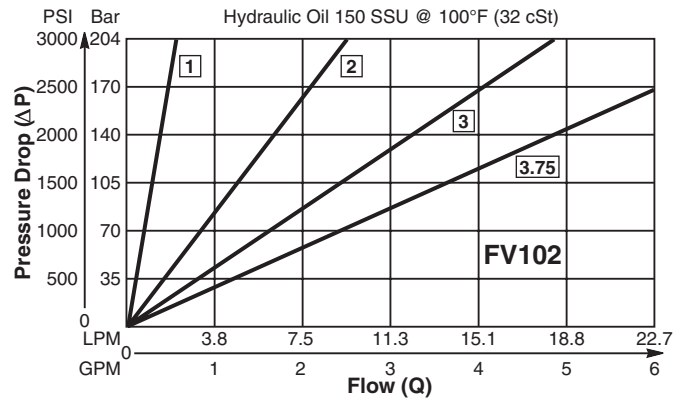
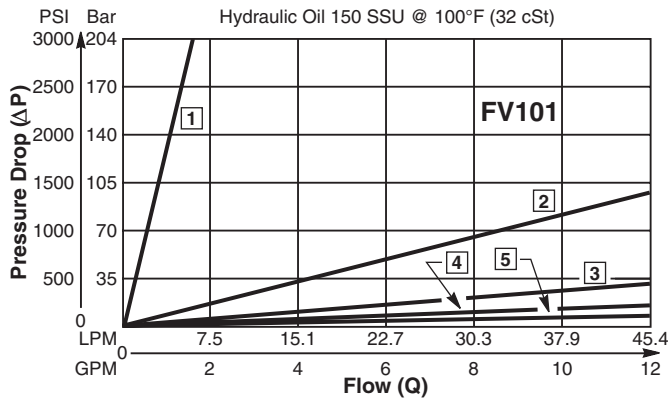

□ = No. of Turns CCW From Fully Closed.

The number on each curve indicates the number of complete turns of the knob or screw adjustment from fully closed. When the metered flow is 22.5 LPM (6 GPM) and the adjustment is two complete turns from closed, the pressure drop will be 13.8 Bar (200 PSI). When the metered flow is 22.5 LPM (6 GPM) and the adjustment is five complete turns from closed, the pressure drop will be 3.5 Bar (50 PSI).

□ = No. of Turns CCW From Fully Closed.

The number on each curve indicates the number of complete turns of the knob or screw adjustment from fully closed (non-metered flow). When the metered flow is 7.5 LPM (2 GPM) and the adjustment is two complete turns from closed, the pressure drop will be 156.9 Bar (2275 PSI). When the metered flow is 7.5 LPM (2 GPM) and the adjustment is 3.75 turns from closed, the pressure drop will be 56.6 Bar (820 PSI).

Ordering Information



Code	Style
1	Coarse Flow
2	Fine Flow

Code	Seals / Kit. No.
Omit	Nitrile / (SK10-2N)
V	Fluorocarbon / (SK10-2V)

Code	Body Material
Omit	Steel
A	Aluminum

Code	Adjustment Style
K	Knob Adjust (840208K)
S	Screw Adjust

Code	Port Size	Body Part No.
Omit	Cartridge Only	
4P	1/4" NPTF	(B10-2-*4P)
6P	3/8" NPTF	(B10-2-*6P)
8P	1/2" NPTF	(B10-2-*8P)
6T	SAE-6	(B10-2-*6T)
8T	SAE-8	(B10-2-*8T)
T8T	SAE-8	(B10-2-T8T)†
6B	3/8" BSPG	(B10-2-6B)†

* Add "A" for aluminum, omit for steel.
 † Steel body only.

Technical Information

- CV** Check Valves
- SH** Shuttle Valves
- LM** Load/Motor Controls
- FC** Flow Controls
- PC** Pressure Controls
- LE** Logic Elements
- DC** Directional Controls
- MV** Manual Valves
- SV** Solenoid Valves
- PV** Proportional Valves
- CE** Coils & Electronics
- BC** Bodies & Cavities
- TD** Technical Data

General Description

Restrictive Style, Pressure Compensated Flow Control Valve. For additional information see Technical Tips on pages FC1-FC4.

Features

- Minimal flow change with pressure variation
- Reverse flow function
- Full adjustment from 1-20 LPM (0.3-5.3 GPM)
- Hardened working parts for maximum durability
- Adjustable and tamperproof versions available
- All external parts zinc plated

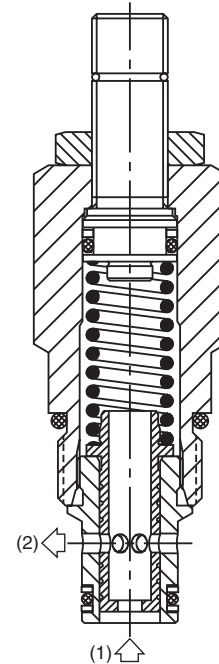
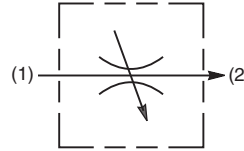

Specifications

Rated Flow	20 LPM (5.3 GPM)
Maximum Inlet Pressure	420 Bar (6000 PSI)
Cartridge Material	All parts steel. All operating parts hardened steel.
Operating Temp. Range/Seals	-40°C to +93.3°C (Nitrile) (-40°F to +200°F) -31.7°C to +121.1°C (Fluorocarbon) (-25°F to +250°F)
Fluid Compatibility/ Viscosity	Mineral-based or synthetic with lubricating properties at viscosities of 45 to 2000 SSU (6 to 420 cSt)
Filtration	ISO Code 16/13, SAE Class 4 or better
Approx. Weight	.13 kg (.29 lbs.)
Cavity	C08-2 (See BC Section for more details)
Form Tool	Rougher None Finisher NFT08-2F

Performance Curves (Through cartridge only)

Flow Regulating Performance

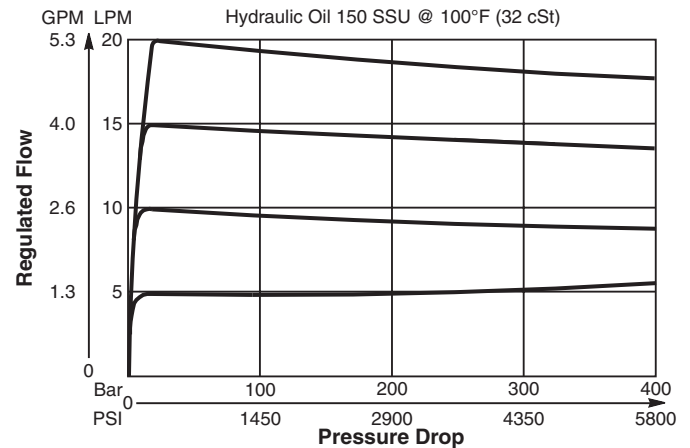

Reverse Flow Pressure Drop vs. Flow

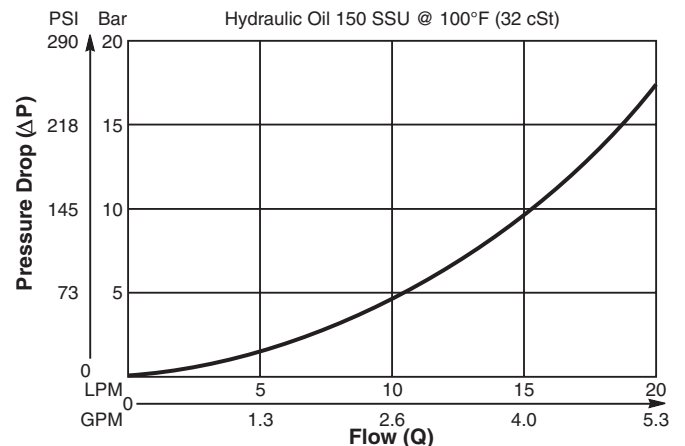

Dimensions Millimeters (Inches)

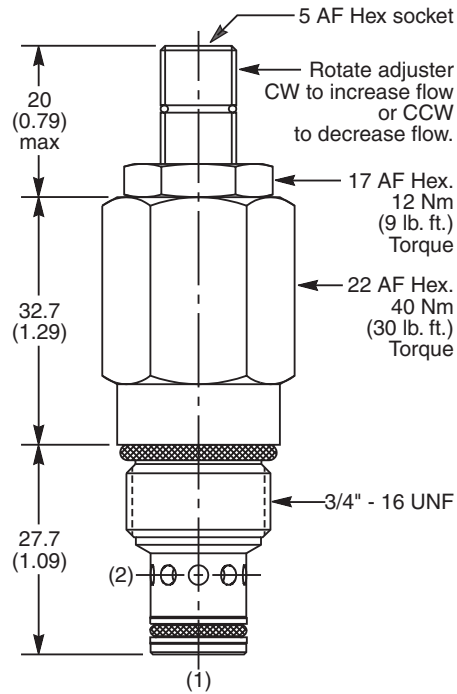

Ordering Information

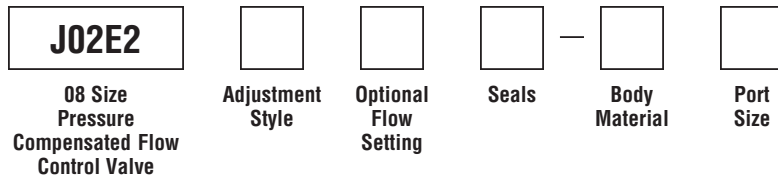

Code	Adjustment Style
Z	Screw Adjust (Std.)
W	Knob Adjust
T	Tamper Resistant Cap (TC1130)

Code	Seals / Kit. No.
N	Nitrile, Buna-N (Std.) / (SK30500N-1)
V	Fluorocarbon / (SK30500V-1)

Code	Body Material
Omit	Steel
A	Aluminum

Code	Port Size	Body Part No.
Omit	Cartridge Only	
4P	1/4" NPTF	(B08-2-*4P)
6P	3/8" NPTF	(B08-2-*6P)
4T	SAE-4	(B08-2-*4T)
6T	SAE-6	(B08-2-*6T)
6B	3/8" BSPG	(B08-2-*6B)

* Add "A" for aluminum, omit for steel.

Code	Optional Flow Setting
Omit	Omit for no setting* Specify setting if required (LPM)

* Appropriate mid-range setting for Standard = 10 LPM

- CV**
Check Valves
- SH**
Shuttle Valves
- LM**
Load/Motor Controls
- FC**
Flow Controls
- PC**
Pressure Controls
- LE**
Logic Elements
- DC**
Directional Controls
- MV**
Manual Valves
- SV**
Solenoid Valves
- PV**
Proportional Valves
- CE**
Coils & Electronics
- BC**
Bodies & Cavities
- TD**
Technical Data

- CV** Check Valves
- SH** Shuttle Valves
- LM** Load/Motor Controls
- FC** Flow Controls
- PC** Pressure Controls
- LE** Logic Elements
- DC** Directional Controls
- MV** Manual Valves
- SV** Solenoid Valves
- PV** Proportional Valves
- CE** Coils & Electronics
- BC** Bodies & Cavities
- TD** Technical Data

General Description

Pressure Compensated Flow Regulator Valve.
NOTE: When used with a fixed displacement pump, pressure to the cartridge must be controlled by a relief valve located between the pump and the FR101 cartridge. For additional information see Technical Tips on pages FC1-FC4.

Features

- Hardened, precision ground parts for durability
- Cartridge design
- Acts as a fixed orifice in reverse flow condition
- All external parts zinc plated

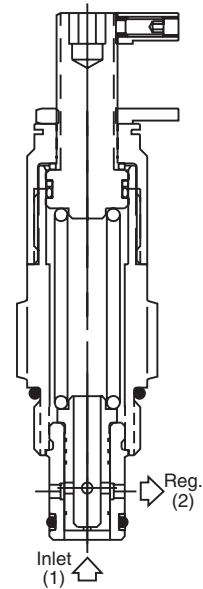
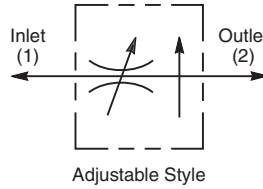

Specifications

Rated Flow	Fixed 22.5 LPM (6 GPM) Adjusted 26.5 LPM (7 GPM)
Maximum Inlet Pressure	245 Bar (3500 PSI)
Accuracy (Fixed)	3.8 LPM (1 GPM) ±20% 7.5 - 11.3 LPM (2-3 GPM) ±15% 15 - 22.5 LPM (4-6 GPM) ±10%
Adjustment Range (Adj. Version)	±30% Nominal
Cartridge Material	All parts steel. All operating parts hardened steel.
Operating Temp. Range/Seals	-40°C to +93.3°C (Nitrile) (-40°F to +200°F) -31.7°C to +121.1°C (Fluorocarbon) (-25°F to +250°F)
Fluid Compatibility/Viscosity	Mineral-based or synthetic with lubricating properties at viscosities of 45 to 2000 SSU (6 to 420 cSt)
Filtration	ISO Code 16/13, SAE Class 4 or better
Approx. Weight	.23 kg (0.5 lbs.)
Cavity	No. C10-2 (See BC Section for more details)
Form Tool	Rougher None Finisher NFT10-2F

Performance Curves Regulated Flow vs. Pressure (Through cartridge only)

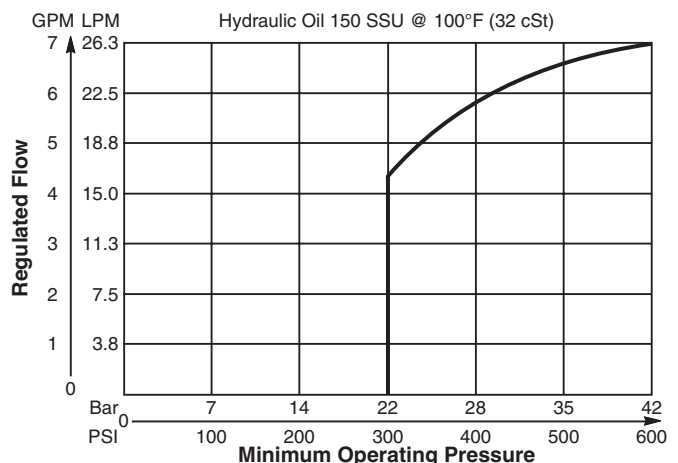
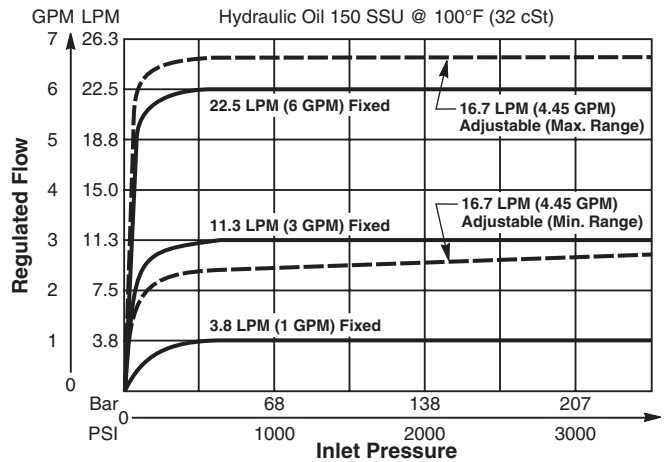

Dimensions Millimeters (Inches)

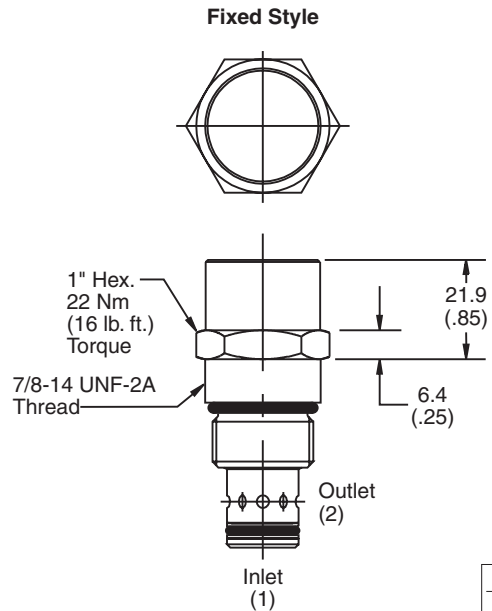
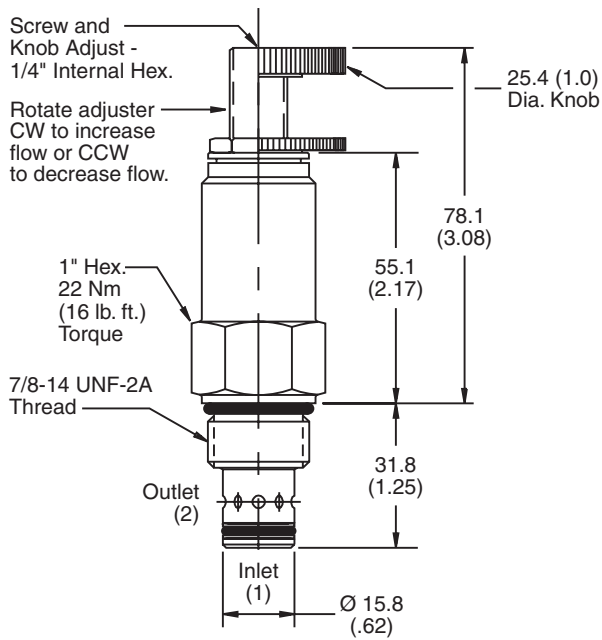

Ordering Information

FR101 -

10 Size Pressure Compensated Flow Regulator (Restrictive) **Adjustment Style** **Flow Setting/Range** **Optional Setting** **Seals** **Body Material** **Port Size**

Code	Adjustment Style
F	Fixed Style present at factory
K	Knob Adjust
S	Screw Adjust

Code	Fixed Style Flow
100	3.8 LPM (1 GPM)
200	7.5 LPM (2 GPM)
300	11.3 LPM (3 GPM)
400	15 LPM (4 GPM)
500	18.8 LPM (5 GPM)
600	22.5 LPM (6 GPM)

Optional Setting
 Flow setting specified in .38 LPM (.1 GPM) increments other than standard

Code	Seals / Kit. No.
Omit	Nitrile / (SK10-2N)
V	Fluorocarbon / (SK10-2V)

Code	Body Material
Omit	Steel
A	Aluminum

Code	Knob/Screw Style Flow Range
065	1.9-3.0 LPM (0.5-0.8 GPM)
095	3.0-4.5 LPM (0.8-1.2 GPM)
135	4.1-6.4 LPM (1.1-1.7 GPM)
185	6.0-8.3 LPM (1.6-2.2 GPM)
260	7.9-11.6 LPM (2.1-3.1 GPM)
375	11.3-16.9 LPM (3.0-4.5 GPM)
550	16.1-25.1 LPM (4.3-6.7 GPM)

Code	Port Size	Body Part No.
Omit	Cartridge Only	
4P	1/4" NPTF	(B10-2-*4P)
6P	3/8" NPTF	(B10-2-*6P)
8P	1/2" NPTF	(B10-2-*8P)
6T	SAE-6	(B10-2-*6T)
8T	SAE-8	(B10-2-*8T)
T8T	SAE-8	(B10-2-T8T)†
6B	3/8" BSPG	(B10-2-6B)†

* Add "A" for aluminum, omit for steel.
 † Steel body only.

- CV Check Valves
- SH Shuttle Valves
- LM Load/Motor Controls
- FC Flow Controls
- PC Pressure Controls
- LE Logic Elements
- DC Directional Controls
- MV Manual Valves
- SV Solenoid Valves
- PV Proportional Valves
- CE Coils & Electronics
- BC Bodies & Cavities
- TD Technical Data

Technical Information

- CV** Check Valves
- SH** Shuttle Valves
- LM** Load/Motor Controls
- FC** Flow Controls
- PC** Pressure Controls
- LE** Logic Elements
- DC** Directional Controls
- MV** Manual Valves
- SV** Solenoid Valves
- PV** Proportional Valves
- CE** Coils & Electronics
- BC** Bodies & Cavities
- TD** Technical Data

General Description

Restrictive Style, Pressure Compensated Flow Control Valve. For additional information see Technical Tips on pages FC1-FC4.

Features

- Minimal flow change with pressure variation
- Reverse flow function
- Full adjustment from 1-40 LPM (0.3-10.6 GPM)
- Hardened working parts for maximum durability
- Adjustable and tamperproof versions available
- All external parts zinc plated

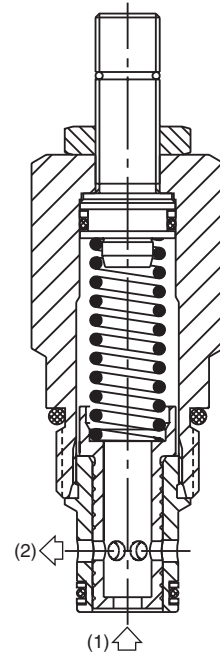
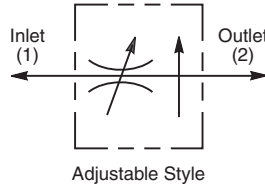
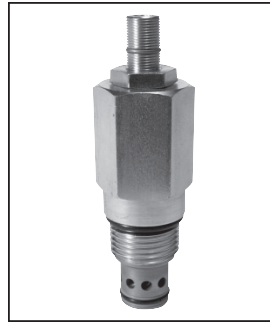

Specifications

Rated Flow	40 LPM (10.6 GPM)
Maximum Inlet Pressure	420 Bar (6000 PSI)
Cartridge Material	All parts steel. All operating parts hardened steel.
Operating Temp. Range/Seals	-40°C to +93.3°C (Nitrile) (-40°F to +200°F) -31.7°C to +121.1°C (Fluorocarbon) (-25°F to +250°F)
Fluid Compatibility/Viscosity	Mineral-based or synthetic with lubricating properties at viscosities of 45 to 2000 SSU (6 to 420 cSt)
Filtration	ISO Code 16/13, SAE Class 4 or better
Approx. Weight	.20 kg (.44 lbs.)
Cavity	C10-2 (See BC Section for more details)
Form Tool	Rougher None Finisher NFT10-2F

Performance Curves (Through cartridge only)

Flow Regulating Performance

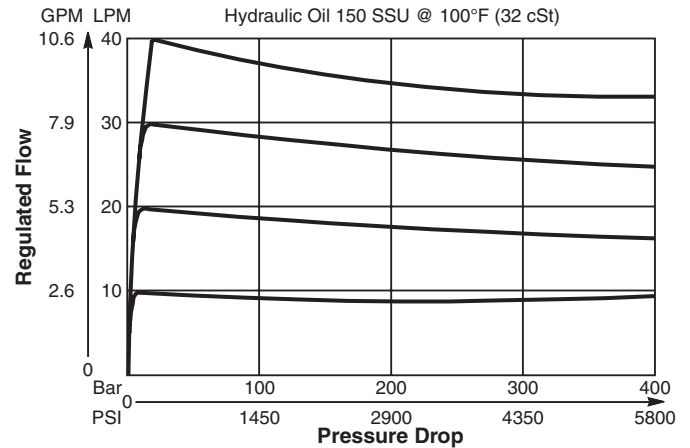

Reverse Flow Pressure Drop vs. Flow

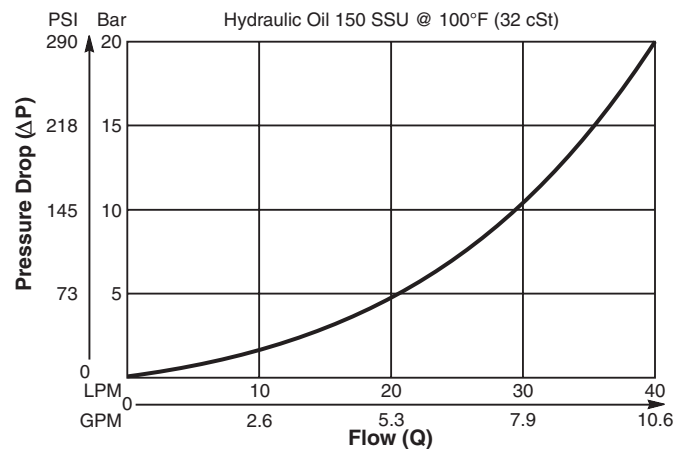

Dimensions Millimeters (Inches)

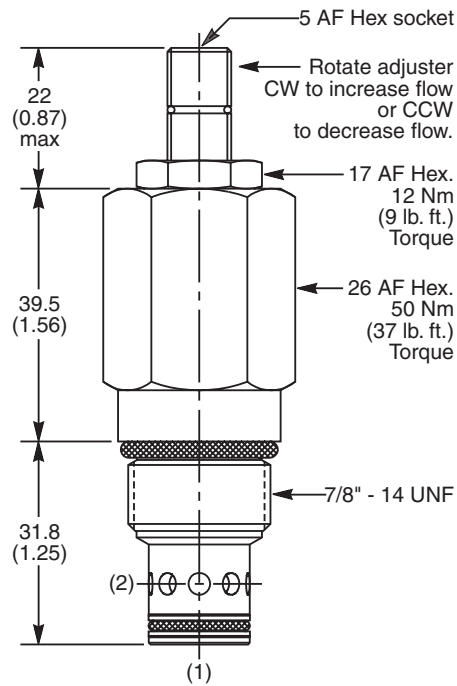

Ordering Information

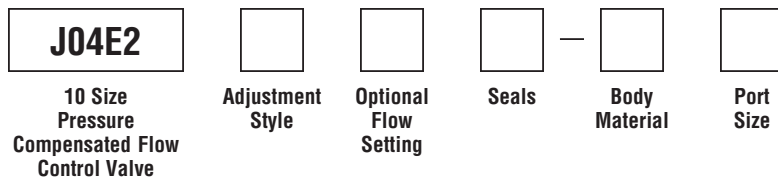

Code	Adjustment Style
Z	Screw Adjust (Std.)
W	Knob Adjust
T	Tamper Resistant Cap (TC1130)

Code	Seals / Kit. No.
N	Nitrile, Buna-N (Std.) / (SK30500N-1)
V	Fluorocarbon / (SK30500V-1)

Code	Body Material
Omit	Steel
A	Aluminum

Code	Port Size	Body Part No.
Omit	Cartridge Only	
4P	1/4" NPTF	(B10-2-*4P)
6P	3/8" NPTF	(B10-2-*6P)
8P	1/2" NPTF	(B10-2-*8P)
6T	SAE-6	(B10-2-*6T)
8T	SAE-8	(B10-2-*8T)
T8T	SAE-8	(B10-2-T8T)†
6B	3/8" BSPG	(B10-2-6B)†

Code	Optional Flow Setting
Omit	Omit for no setting* Specify setting if required (LPM)

* Appropriate mid-range setting for Standard = 20 LPM

* Add "A" for aluminum, omit for steel.
 † Steel body only.

Technical Information

- CV** Check Valves
- SH** Shuttle Valves
- LM** Load/Motor Controls
- FC** Flow Controls
- PC** Pressure Controls
- LE** Logic Elements
- DC** Directional Controls
- MV** Manual Valves
- SV** Solenoid Valves
- PV** Proportional Valves
- CE** Coils & Electronics
- BC** Bodies & Cavities
- TD** Technical Data

General Description

Restrictive Variable Orifice Style, Pressure Compensated Flow Control Valve. For additional information see Technical Tips on pages FC1-FC4.

Features

- Minimal flow change with pressure variation
- Partial reverse flow capability
- Full adjustment from 1-40 LPM (0.3-10.6 GPM)
- Hardened working parts for maximum durability
- Adjustable and tamperproof versions available
- All external parts zinc plated

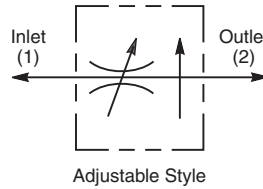
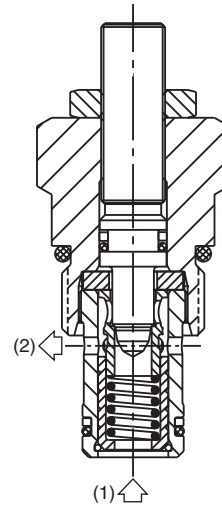

Specifications

Rated Flow	40 LPM (10.6 GPM)
Maximum Inlet Pressure	420 Bar (6000 PSI)
Cartridge Material	All parts steel. All operating parts hardened steel.
Operating Temp. Range/Seals	-40°C to +93.3°C (Nitrile) (-40°F to +200°F) -31.7°C to +121.1°C (Fluorocarbon) (-25°F to +250°F)
Fluid Compatibility/Viscosity	Mineral-based or synthetic with lubricating properties at viscosities of 45 to 2000 SSU (6 to 420 cSt)
Filtration	ISO Code 16/13, SAE Class 4 or better
Approx. Weight	.15 kg (.33 lbs.)
Cavity	C10-2 (See BC Section for more details)
Form Tool	Rougher None Finisher NFT10-2F

Performance Curves (Through cartridge only)

Flow Regulating Performance 2 to 1

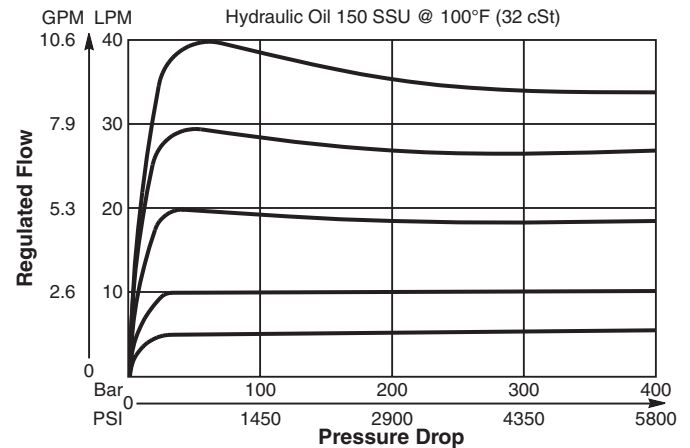

Reverse Flow Pressure Drop vs. Flow 2 to 1

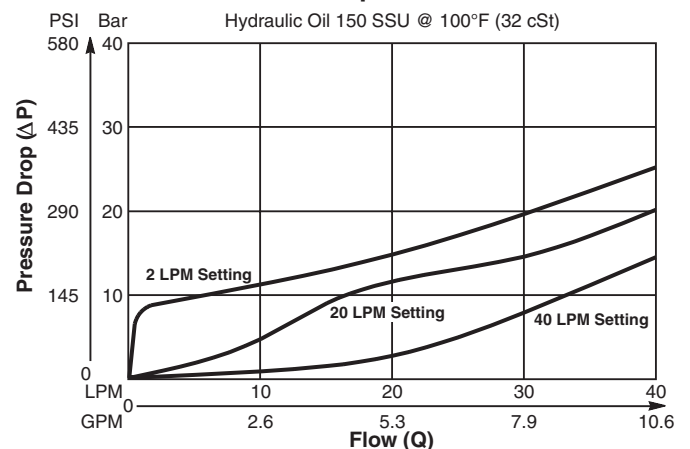

Dimensions Millimeters (Inches)

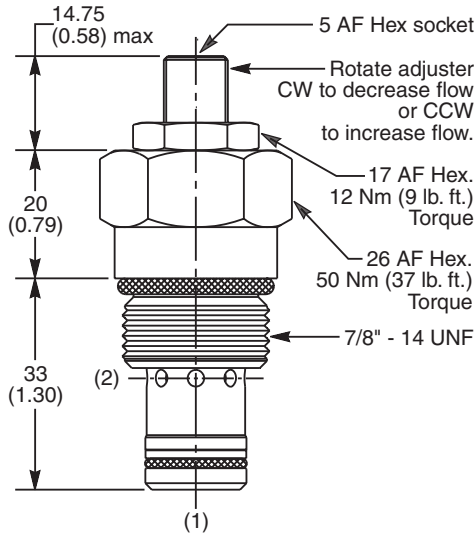

Ordering Information

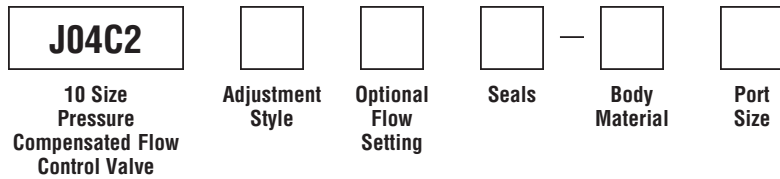

Code	Adjustment Style
Z	Screw Adjust (Std.)
W	Knob Adjust
T	Tamper Resistant Cap (TC1130)

Code	Seals / Kit. No.
N	Nitrile, Buna-N (Std.) / (SK30503N-1)
V	Fluorocarbon / (SK30503V-1)

Code	Body Material
Omit	Steel
A	Aluminum

Code	Port Size	Body Part No.
Omit	Cartridge Only	
4P	1/4" NPTF	(B10-2-*4P)
6P	3/8" NPTF	(B10-2-*6P)
8P	1/2" NPTF	(B10-2-*8P)
6T	SAE-6	(B10-2-*6T)
8T	SAE-8	(B10-2-*8T)
T8T	SAE-8	(B10-2-T8T)†
6B	3/8" BSPG	(B10-2-6B)†

Code	Optional Flow Setting
Omit	Omit for no setting* Specify setting if required (LPM)

* Appropriate mid-range setting for Standard = 20 LPM

* Add "A" for aluminum, omit for steel.
 † Steel body only.

Technical Information

- CV Check Valves
- SH Shuttle Valves
- LM Load/Motor Controls
- FC Flow Controls
- PC Pressure Controls
- LE Logic Elements
- DC Directional Controls
- MV Manual Valves
- SV Solenoid Valves
- PV Proportional Valves
- CE Coils & Electronics
- BC Bodies & Cavities
- TD Technical Data

General Description

Fully Adjustable, Pressure Compensated Flow Control Valve. For additional information see Technical Tips on pages FC1-FC4.

Features

- Fully adjustable from 0.75 LPM (0.2 GPM) to 20.6 LPM (5.5 GPM)
- Hardened, precision ground parts for durability
- All external parts are finished in yellow zinc dichromate. This enables them to withstand a 200 hour salt spray test.
- Compact size for reduced space requirements

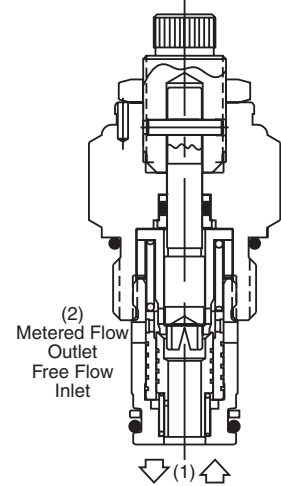
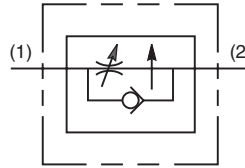
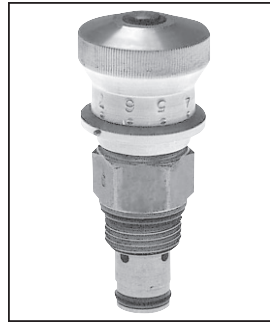

Specifications

Rated Flow	0.75 LPM (0.2 GPM) 20.6 LPM (5.5 GPM)
Maximum Inlet Pressure	210 Bar (3000 PSI)
Cartridge Material	All parts steel. All operating parts hardened steel.
Operating Temp. Range/Seals	-40°C to +93.3°C (Nitrile) (-40°F to +200°F) -31.7°C to +121.1°C (Fluorocarbon) (-25°F to +250°F)
Fluid Compatibility/ Viscosity	Mineral-based or synthetic with lubricating properties at viscosities of 45 to 2000 SSU (6 to 420 cSt)
Filtration	ISO Code 16/13, SAE Class 4 or better
Approx. Weight	.23 kg (0.5 lbs.)
Cavity	C10-2 (See BC Section for more details)
Form Tool	Rougher None Finisher NFT10-2F

Performance Curves

Regulated Flow vs. Pressure Drop
(Through cartridge only)

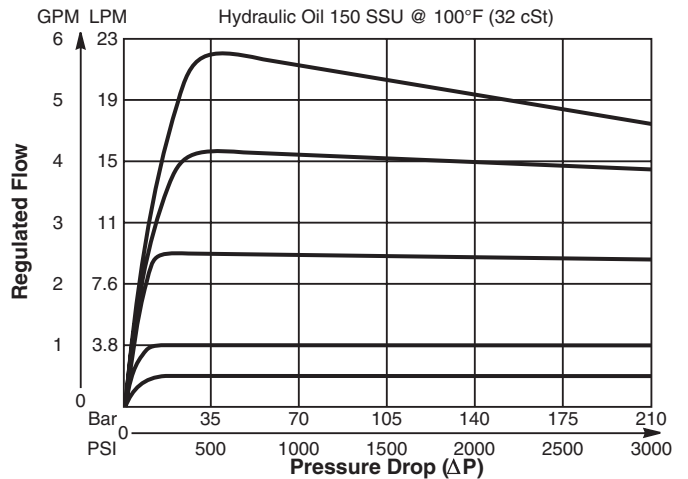

Dimensions Millimeters (Inches)

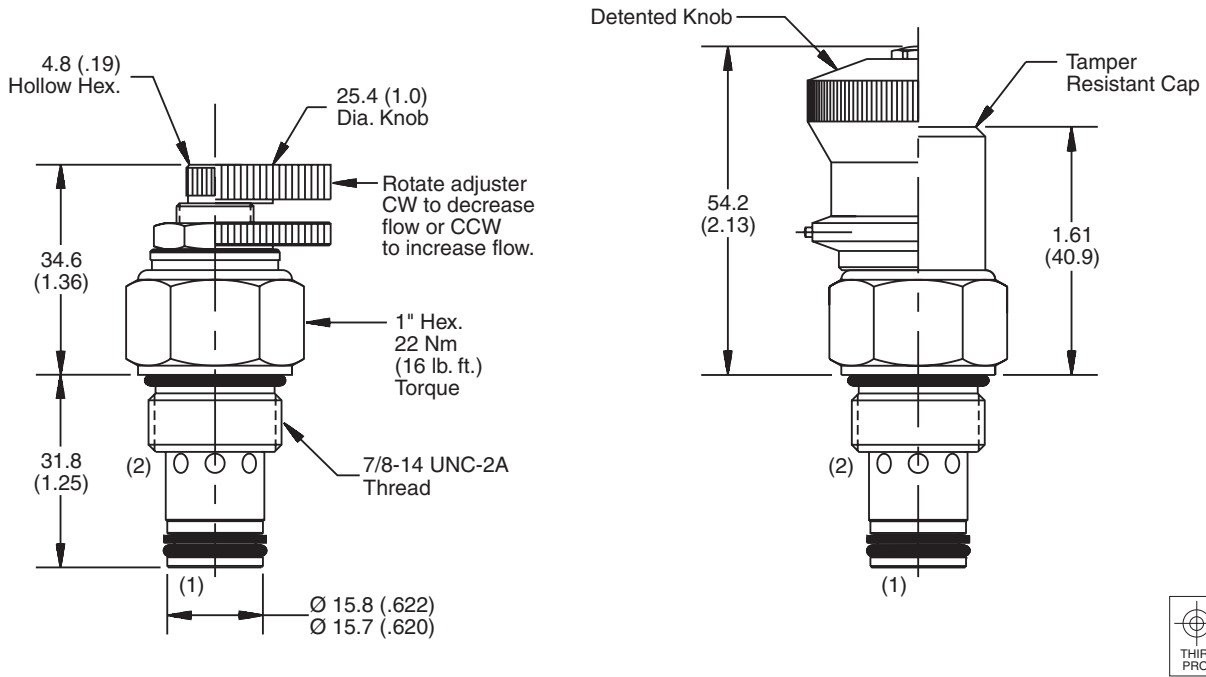

Ordering Information

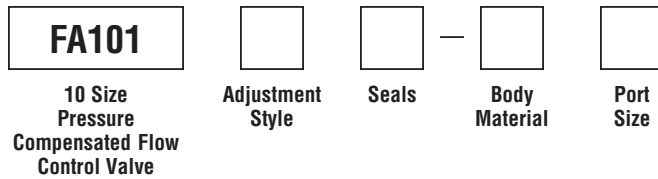

Code	Adjustment Style
D	Detented Knob
K	Knob Adjust (717784-10)
S	Screw Adjust
T	Tamper Resistant Cap (717785)

Code	Seals / Kit. No.
Omit	Nitrile / (SK10-2N)
V	Fluorocarbon / (SK10-2V)

Code	Body Material
Omit	Steel
A	Aluminum

Code	Port Size	Body Part No.
Omit	Cartridge Only	
4P	1/4" NPTF	(B10-2-*4P)
6P	3/8" NPTF	(B10-2-*6P)
8P	1/2" NPTF	(B10-2-*8P)
6T	SAE-6	(B10-2-*6T)
8T	SAE-8	(B10-2-*8T)
T8T	SAE-8	(B10-2-T8T)†
6B	3/8" BSPG	(B10-2-*6B)

* Add "A" for aluminum, omit for steel.
 † Steel body only.

Technical Information

- CV** Check Valves
- SH** Shuttle Valves
- LM** Load/Motor Controls
- FC** Flow Controls
- PC** Pressure Controls
- LE** Logic Elements
- DC** Directional Controls
- MV** Manual Valves
- SV** Solenoid Valves
- PV** Proportional Valves
- CE** Coils & Electronics
- BC** Bodies & Cavities
- TD** Technical Data

General Description

Pressure Compensated Flow Control. For additional information see Technical Tips on pages FC1-FC4.

Features

- Hardened, precision ground parts for durability
- Compact size for reduced space requirements
- Free flow in reverse condition
- All external parts zinc plated

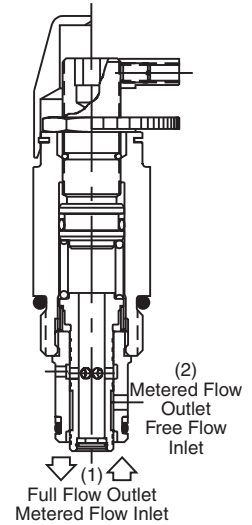
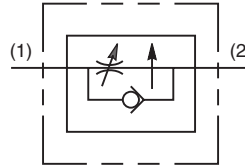
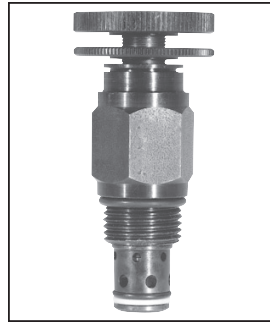

Specifications

Rated Flow	20.6 LPM (5.5 GPM)
Maximum Inlet Pressure	210 Bar (3000 PSI)
Cartridge Material	All parts steel. All operating parts hardened steel.
Operating Temp. Range/Seals	-40°C to +93.3°C (Nitrile) (-40°F to +200°F) -31.7°C to +121.1°C (Fluorocarbon) (-25°F to +250°F)
Fluid Compatibility/ Viscosity	Mineral-based or synthetic with lubricating properties at viscosities of 45 to 2000 SSU (6 to 420 cSt)
Filtration	ISO Code 16/13, SAE Class 4 or better
Approx. Weight	.23 kg (0.5 lbs.)
Cavity	C10-2 (See BC Section for more details)
Form Tool	Rougher None Finisher NFT10-2F

Performance Curves

Regulated Flow vs. Pressure Drop
(Through cartridge only)

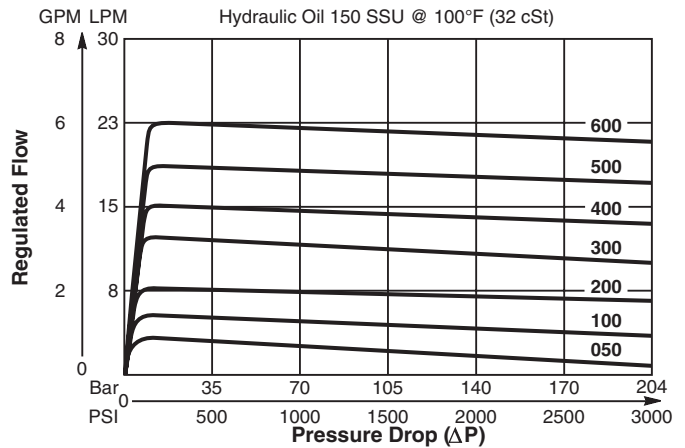

Pressure Drop vs. Flow (Through cartridge only)

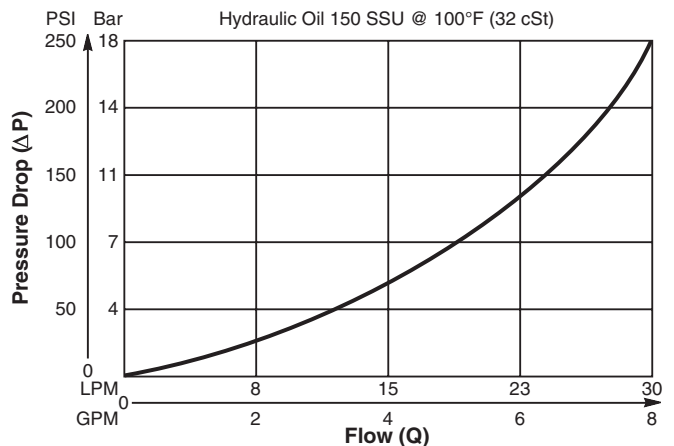

Dimensions Millimeters (Inches)

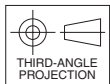
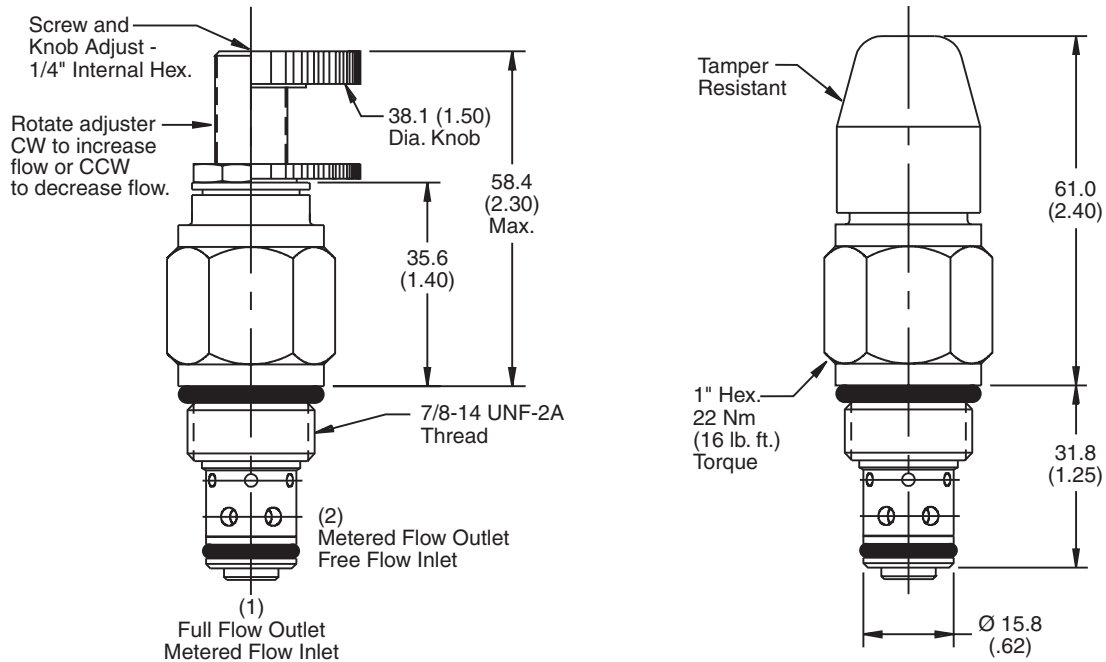

Ordering Information

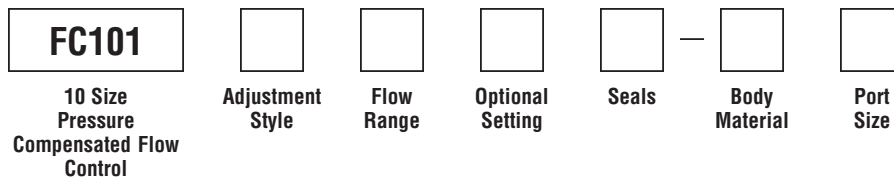

Code	Adjustment Style
K	Knob Adjust (840208K)
S	Screw Adjust
T	Tamper Resistant Cap (717783)

Code	Optional Setting
	Flow setting specified in .38 LPM (.1 GPM) increments other than standard

Code	Body Material
Omit	Steel
A	Aluminum

Code	Flow Range and Standard Setting
050	1.1-3.8 LPM (.30-1.0 GPM) (1.9 LPM (.5 GPM) @ 69 Bar (1000 PSI) ΔP)
100	2.8-8.3 LPM (.75-2.2 GPM) (3.8 LPM (1 GPM) @ 69 Bar (1000 PSI) ΔP)
300	7.5-16.9 LPM (2.0-4.5 GPM) (11.3 LPM (3 GPM) @ 69 Bar (1000 PSI) ΔP)
600	15-30 LPM (4.0-8.0 GPM) (22.5 LPM (6 GPM) @ 69 Bar (1000 PSI) ΔP)

Code	Seals / Kit. No.
Omit	Nitrile / (SK10-2N)
V	Fluorocarbon / (SK10-2V)

Code	Port Size	Body Part No.
Omit	Cartridge Only	
4P	1/4" NPTF	(B10-2-*4P)
6P	3/8" NPTF	(B10-2-*6P)
8P	1/2" NPTF	(B10-2-*8P)
6T	SAE-6	(B10-2-*6T)
8T	SAE-8	(B10-2-*8T)
T8T	SAE-8	(B10-2-T8T)†
6B	3/8" BSPG	(B10-2-6B)†

* Add "A" for aluminum, omit for steel.
 † Steel body only.

Technical Information

- CV** Check Valves
- SH** Shuttle Valves
- LM** Load/Motor Controls
- FC** Flow Controls
- PC** Pressure Controls
- LE** Logic Elements
- DC** Directional Controls
- MV** Manual Valves
- SV** Solenoid Valves
- PV** Proportional Valves
- CE** Coils & Electronics
- BC** Bodies & Cavities
- TD** Technical Data

General Description

Needle Type, Pressure Compensated Flow Regulator Valve. For additional information see Technical Tips on pages FC1-FC4.

Features

- Good adjustment from 1-15 LPM (0.3-4 GPM)
- Used for systems requiring priority flow such as steering systems
- Hardened working parts for maximum durability
- Reverse flow function 3 to 1
- Adjustable and tamperproof versions available
- All external parts zinc plated

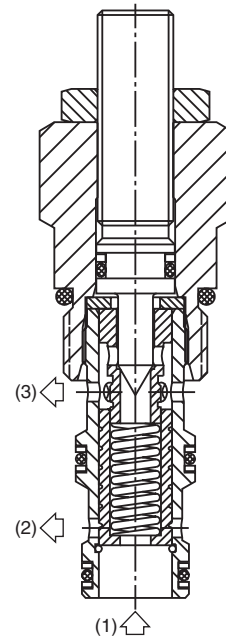
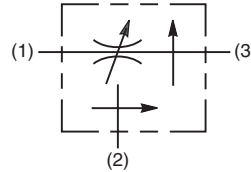

Specifications

Rated Flow	15 LPM (4 GPM)
Maximum Inlet Pressure	420 Bar (6000 PSI)
Cartridge Material	All parts steel. All operating parts hardened steel.
Operating Temp. Range/Seals	-40°C to +93.3°C (Nitrile) (-40°F to +200°F) -31.7°C to +121.1°C (Fluorocarbon) (-25°F to +250°F)
Fluid Compatibility/ Viscosity	Mineral-based or synthetic with lubricating properties at viscosities of 45 to 2000 SSU (6 to 420 cSt)
Filtration	ISO Code 16/13, SAE Class 4 or better
Approx. Weight	.08 kg (.18 lbs.)
Cavity	C08-3 (See BC Section for more details)
Form Tool	Rougher NFT08-3R Finisher NFT08-3F

Performance Curves (Through cartridge only)

Flow Regulating Performance

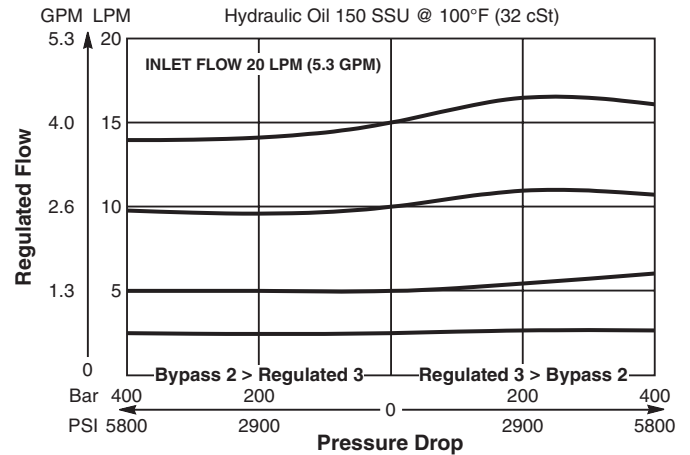

Application

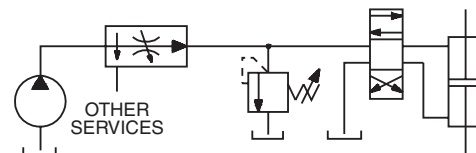

Priority flow on steering circuit

Dimensions Millimeters (Inches)

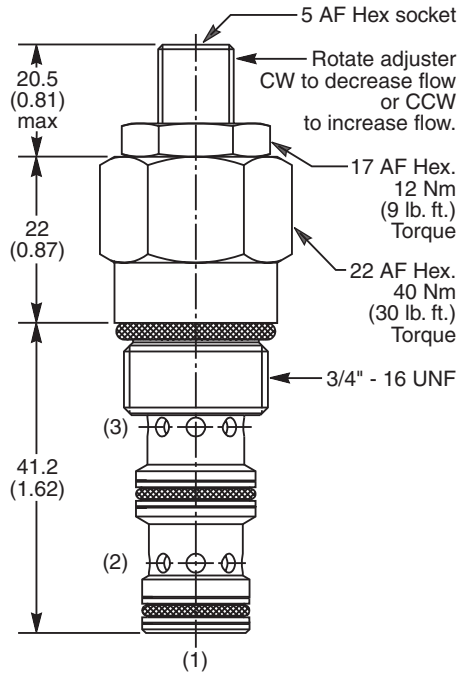

Ordering Information

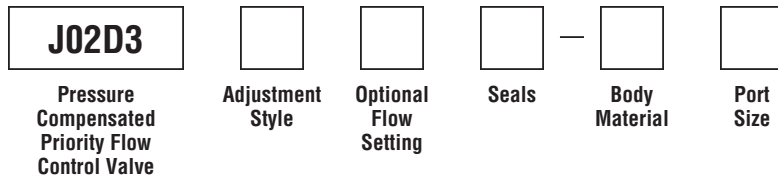

Code	Adjustment Style
Z	Screw Adjust (Std.)
W	Knob Adjust
T	Tamper Resistant Cap (TC1130)

Code	Seals / Kit. No.
N	Nitrile, Buna-N (Std.) / (SK30501N-1)
V	Fluorocarbon / (SK30501V-1)

Code	Body Material
Omit	Steel
A	Aluminum

Code	Port Size	Body Part No.
Omit	Cartridge Only	
4P	1/4" NPTF	(B08-3-*4P)
4T	SAE-4	(B08-3-*4T)
6T	SAE-6	(B08-3-*6T)
6B	3/8" BSPG	(B08-3-*6B)

* Add "A" for aluminum, omit for steel.

Code	Optional Flow Setting
Omit	Omit for no setting* Specify setting if required (LPM)

* Appropriate mid-range setting for Standard = 7 LPM

- CV**
Check Valves
- SH**
Shuttle Valves
- LM**
Load/Motor Controls
- FC**
Flow Controls
- PC**
Pressure Controls
- LE**
Logic Elements
- DC**
Directional Controls
- MV**
Manual Valves
- SV**
Solenoid Valves
- PV**
Proportional Valves
- CE**
Coils & Electronics
- BC**
Bodies & Cavities
- TD**
Technical Data

Technical Information

- CV** Check Valves
- SH** Shuttle Valves
- LM** Load/Motor Controls
- FC** Flow Controls
- PC** Pressure Controls
- LE** Logic Elements
- DC** Directional Controls
- MV** Manual Valves
- SV** Solenoid Valves
- PV** Proportional Valves
- CE** Coils & Electronics
- BC** Bodies & Cavities
- TD** Technical Data

General Description

Pressure Compensated Priority Flow Regulator Valve. For additional information see Technical Tips on pages FC1-FC4.

Caution: If the priority line is blocked so that no flow can pass through the control orifice; the compensator spool will shift, blocking the bypass port and allowing inlet pressure to go to full system relief pressure. The FP101 cartridge does not provide a pressure relieving function.

Specifications

Maximum Priority Flow	Fixed 30.0 LPM (8 GPM) Adjusted 33.8 LPM (9 GPM)
Maximum Inlet Flow	56.3 LPM (15 GPM)
Minimum Inlet Flow	See Valve Performance Curves
Maximum Inlet Pressure	245 Bar (3500 PSI)
Minimum Inlet Pressure	See Valve Performance Curves
Accuracy (Fixed)	±20%
Adjustment Range (Adj. Version)	±20% Nominal
Cartridge Material	All parts steel. All operating parts hardened steel.
Operating Temp. Range/Seals	-40°C to +93.3°C (Nitrile) (-40°F to +200°F) -31.7°C to +121.1°C (Fluorocarbon) (-25°F to +250°F)
Fluid Compatibility/Viscosity	Mineral-based or synthetic with lubricating properties at viscosities of 45 to 2000 SSU (6 to 420 cSt)
Filtration	ISO Code 16/13, SAE Class 4 or better
Approx. Weight	.23 kg (0.5 lbs.)
Cavity	No. C10-3 (See BC Section for more details)
Form Tool	Regulator NFT10-3R Finisher NFT10-3F

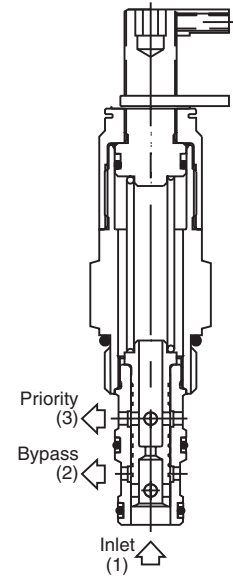
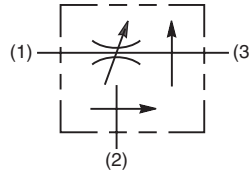

Features

- Hardened, precision ground parts for durability
- Cartridge design
- Acts as a fixed orifice in reverse flow condition (Priority line only)
- All external parts zinc plated

Dimensions Millimeters (Inches)

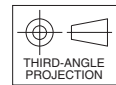
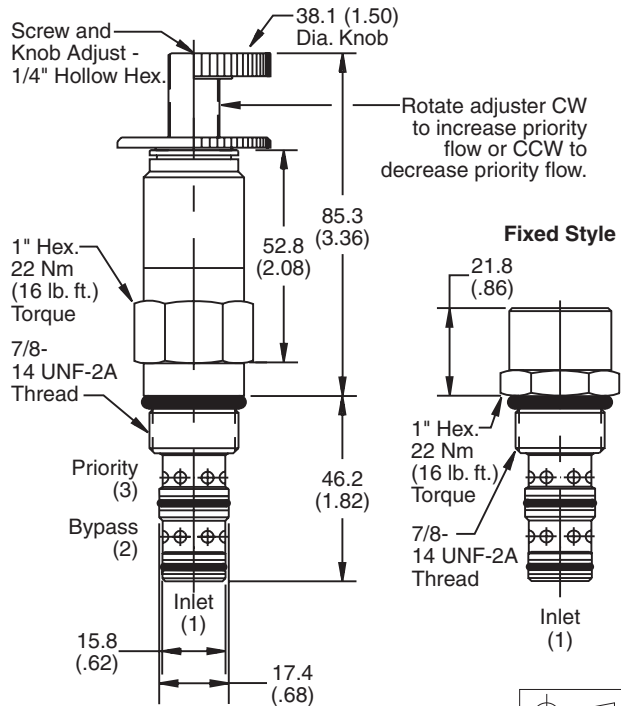

Performance Curves (Through cartridge only)

Regulated Flow vs. Load Pressure

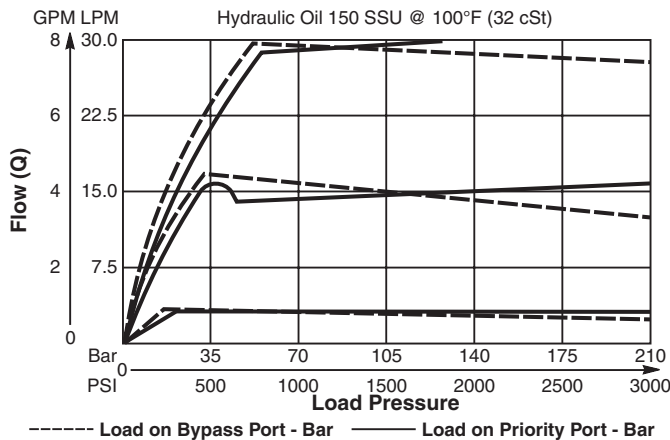

**Pressure vs. Priority Flow
 Minimum Operating Pressure**

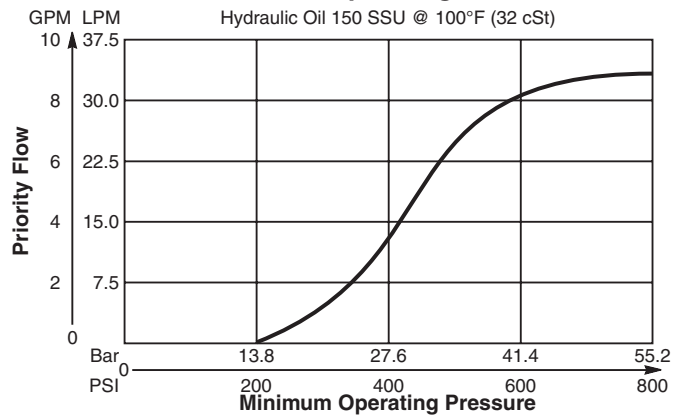

Minimum Inlet Flow

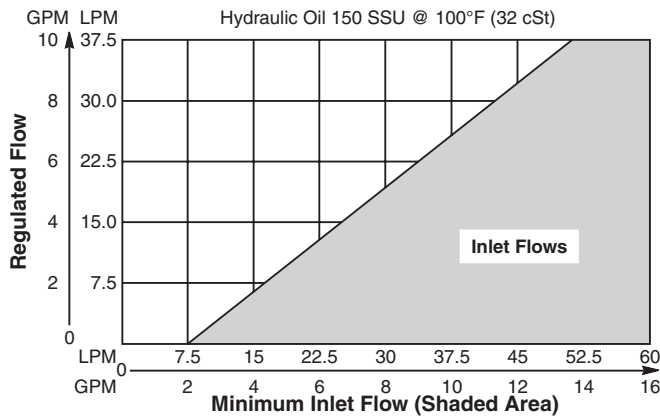

Inlet Flow vs. Regulated Flow

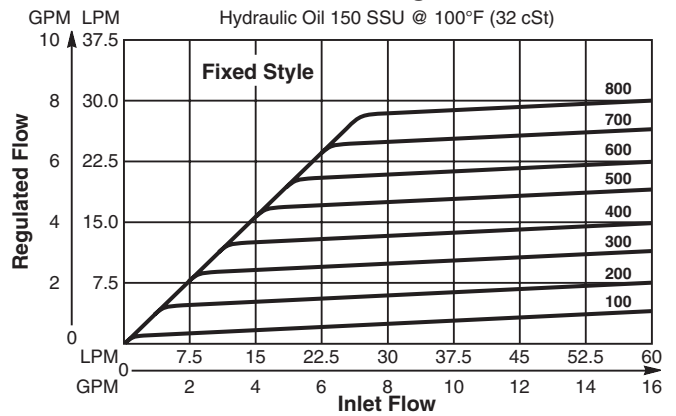

Ordering Information

FP101 —

10 Size Pressure Compensated Flow Regulator **Adjustment Style** **Flow Setting/Range** **Seals** **Body Material** **Port Size**

Code	Adjustment Style
F	Fixed Style present at factory
K	Knob Adjust
S	Screw Adjust

Code	Fixed Style Flow	Code	Knob/Screw Style Flow Range
100	3.8 LPM (1 GPM)	085	2.6-3.8 LPM (0.7-1.0 GPM)
200	7.5 LPM (2 GPM)	110	3.0-5.3 LPM (0.8-1.4 GPM)
300	11.3 LPM (3 GPM)	155	4.5-7.1 LPM (1.2-1.9 GPM)
400	15 LPM (4 GPM)	220	6.4-10.1 LPM (1.7-2.7 GPM)
500	18.8 LPM (5 GPM)	295	8.6-13.5 LPM (2.3-3.6 GPM)
600	22.5 LPM (6 GPM)	405	11.6-18.8 LPM (3.1-5.0 GPM)
700	26.3 LPM (7 GPM)	575	16.9-26.3 LPM (4.5-7.0 GPM)
800	30 LPM (8 GPM)	780	23.6-34.9 LPM (6.3-9.3 GPM)

Code	Seals / Kit. No.
Omit	Nitrile / (SK10-3N)
V	Fluorocarbon / (SK10-3V)

Code	Body Material
Omit	Steel
A	Aluminum

Code	Port Size	Body Part No.
Omit	Cartridge Only	
4P	1/4" NPTF	(B10-3-*4P)
6P	3/8" NPTF	(B10-3-*6P)
8P	1/2" NPTF	(B10-3-*8P)
6T	SAE-6	(B10-3-*6T)
8T	SAE-8	(B10-3-*8T)
6B	3/8" BSPG	(B10-3-6B)†
8B	1/2" BSPG	(B10-3-*8B)

* Add "A" for aluminum, omit for steel.
 † Steel body only.



- CV**
- Check Valves
- SH**
- Shuttle Valves
- LM**
- Load/Motor Controls
- FC**
- Flow Controls
- PC**
- Pressure Controls
- LE**
- Logic Elements
- DC**
- Directional Controls
- MV**
- Manual Valves
- SV**
- Solenoid Valves
- PV**
- Proportional Valves
- CE**
- Coils & Electronics
- BC**
- Bodies & Cavities
- TD**
- Technical Data

Technical Information

- CV** Check Valves
- SH** Shuttle Valves
- LM** Load/Motor Controls
- FC** Flow Controls
- PC** Pressure Controls
- LE** Logic Elements
- DC** Directional Controls
- MV** Manual Valves
- SV** Solenoid Valves
- PV** Proportional Valves
- CE** Coils & Electronics
- BC** Bodies & Cavities
- TD** Technical Data

General Description

Priority Type, Pressure Compensated Flow Regulator Valve. For additional information see Technical Tips on pages FC1-FC4.

Features

- High flow capacity
- Good adjustment from 2-45 LPM (0.5-12 GPM)
- Used for systems requiring priority flow such as steering systems
- Hardened working parts for maximum durability
- Reverse flow function 3 to 1
- Adjustable and tamperproof versions available
- All external parts zinc plated

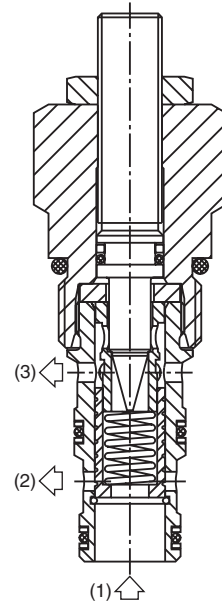
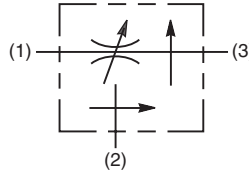
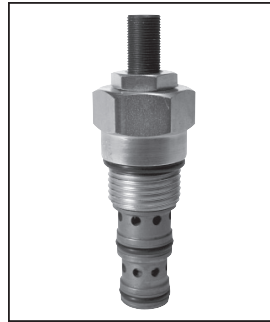

Specifications

Rated Flow	45 LPM (12 GPM)
Maximum Inlet Pressure	420 Bar (6000 PSI)
Cartridge Material	All parts steel. All operating parts hardened steel.
Operating Temp. Range/Seals	-40°C to +93.3°C (Nitrile) (-40°F to +200°F) -31.7°C to +121.1°C (Fluorocarbon) (-25°F to +250°F)
Fluid Compatibility/ Viscosity	Mineral-based or synthetic with lubricating properties at viscosities of 45 to 2000 SSU (6 to 420 cSt)
Filtration	ISO Code 16/13, SAE Class 4 or better
Approx. Weight	.18 kg (.40 lbs.)
Cavity	C10-3 (See BC Section for more details)
Form Tool	Rougher NFT10-3R Finisher NFT10-3F

Performance Curves (Through cartridge only)

Flow Regulating Performance

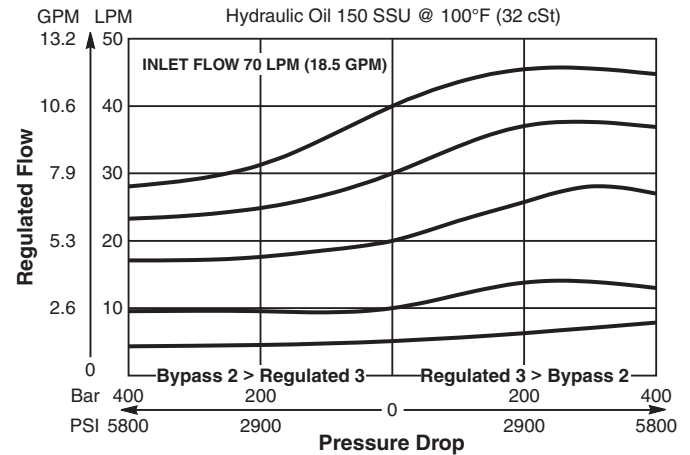

Application

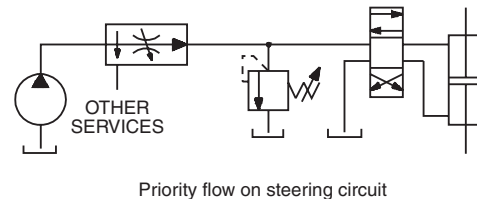

Dimensions Millimeters (Inches)

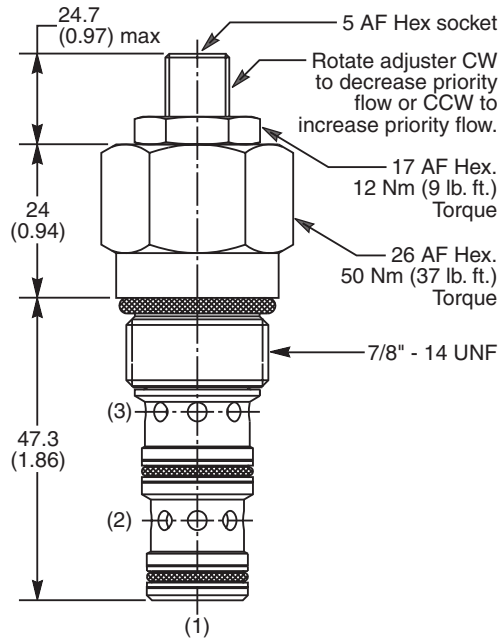

Ordering Information

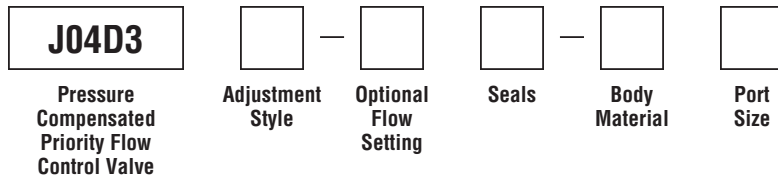

Code	Adjustment Style
Z	Screw Adjust (Std.)
W	Knob Adjust (ASV014975)
T	Tamper Resistant Cap (TC1130)

Code	Seals / Kit. No.
N	Nitrile, Buna-N (Std.) / (SK30505N-1)
V	Fluorocarbon / (SK30505V-1)

Code	Body Material
Omit	Steel
A	Aluminum

Code	Port Size	Body Part No.
Omit	Cartridge Only	
4P	1/4" NPTF	(B10-3-*4P)
6P	3/8" NPTF	(B10-3-*6P)
8P	1/2" NPTF	(B10-3-*8P)
6T	SAE-6	(B10-3-*6T)
8T	SAE-8	(B10-3-*8T)
6B	3/8" BSPG	(B10-3-6B)†
8B	1/2" BSPG	(B10-3-*8B)

Code	Optional Flow Setting
Omit	Omit for no setting*
	Specify setting if required (LPM)

* Appropriate mid-range setting for Standard = 20 LPM

* Add "A" for aluminum, omit for steel.
 † Steel body only.

Technical Information

- CV** Check Valves
- SH** Shuttle Valves
- LM** Load/Motor Controls
- FC** Flow Controls
- PC** Pressure Controls
- LE** Logic Elements
- DC** Directional Controls
- MV** Manual Valves
- SV** Solenoid Valves
- PV** Proportional Valves
- CE** Coils & Electronics
- BC** Bodies & Cavities
- TD** Technical Data

General Description

Priority Style, Pressure Compensated Flow Regulator Valve With Bypass. For additional information see Technical Tips on pages FC1-FC4.

Features

- Free reverse flow function
- High flow capacity
- Used for systems requiring priority flow such as steering systems
- Hardened working parts for maximum durability
- Adjustable and tamperproof versions available
- All external parts zinc plated

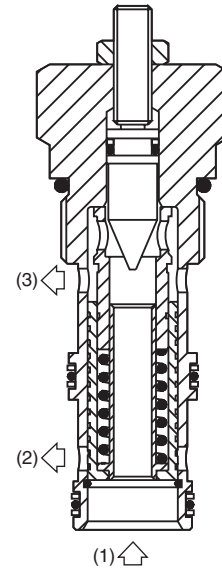
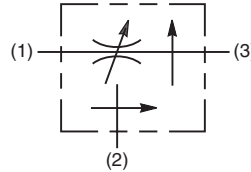

Specifications

Rated Flow	90 LPM (24 GPM)
Maximum Regulated Flow	38 LPM (10 GPM)
Maximum Inlet Pressure	350 Bar (5000 PSI)
Cartridge Material	All parts steel. All operating parts hardened steel.
Operating Temp. Range/Seals	-40°C to +93.3°C (Nitrile) (-40°F to +200°F) -31.7°C to +121.1°C (Fluorocarbon) (-25°F to +250°F)
Fluid Compatibility/ Viscosity	Mineral-based or synthetic with lubricating properties at viscosities of 45 to 2000 SSU (6 to 420 cSt)
Filtration	ISO Code 16/13, SAE Class 4 or better
Approx. Weight	.45 kg (1.00 lbs.)
Cavity	3A (See BC Section for more details)
Form Tool	Rougher Finisher

Performance Curve (Through cartridge only)

Flow Regulating Performance

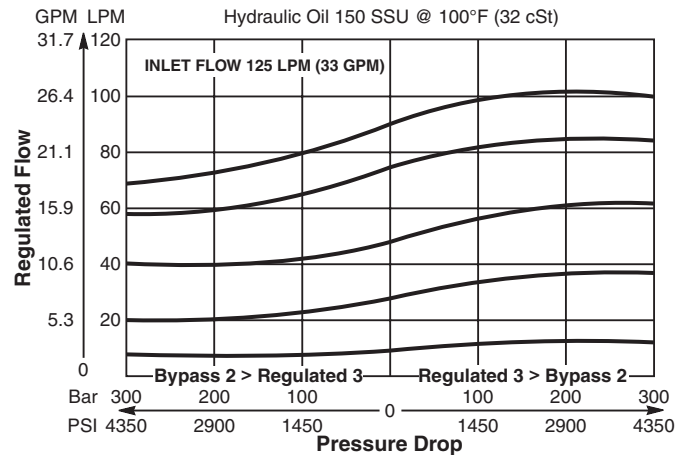

Application

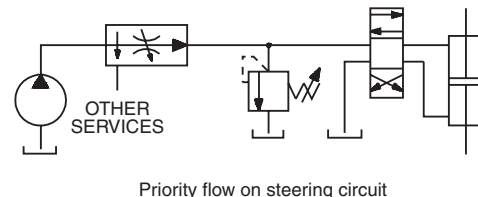

Dimensions Millimeters (Inches)

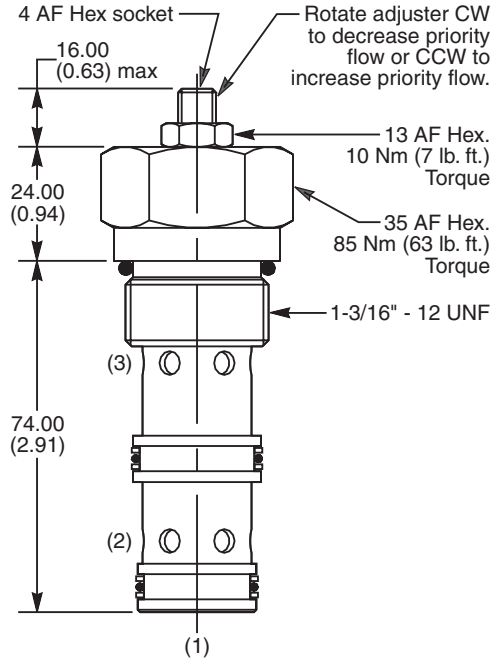

Ordering Information

J1A125			
Pressure Compensated Priority Flow Control Valve	Adjustment Style	Optional Regulated Flow Setting	Seals

Code	Adjustment Style
Z	Screw Adjust (Std.)
W	Knob Adjust
T	Tamper Resistant Cap (TC1124)

Code	Seals / Kit. No.
N	Nitrile, Buna-N (Std.) / (SK30011N-1)
V	Fluorocarbon / (SK30011V-1)

Code	Optional Regulated Flow Setting
Omit	Omit for no setting (Std.)* Specify setting if required (LPM)

* Setting for standard: J1A125
 Inlet: 45 LPM (12 GPM)
 Regulated: 25 LPM (6.5 GPM)

Order Bodies Separately

LB10		
Line Body	Porting	Body Material

Code	Porting
007	3/4" BSP
066	1" SAE

Code	Body Material
A	Aluminum
S	Steel

- CV**
Check Valves
- SH**
Shuttle Valves
- LM**
Load/Motor Controls
- FC**
Flow Controls
- PC**
Pressure Controls
- LE**
Logic Elements
- DC**
Directional Controls
- MV**
Manual Valves
- SV**
Solenoid Valves
- PV**
Proportional Valves
- CE**
Coils & Electronics
- BC**
Bodies & Cavities
- TD**
Technical Data

Technical Information

- CV Check Valves
- SH Shuttle Valves
- LM Load/Motor Controls
- FC Flow Controls
- PC Pressure Controls
- LE Logic Elements
- DC Directional Controls
- MV Manual Valves
- SV Solenoid Valves
- PV Proportional Valves
- CE Coils & Electronics
- BC Bodies & Cavities
- TD Technical Data

General Description

Restrictive Type Pressure Compensator. This valve is designed to be used in conjunction with an external orifice, fixed or variable, to provide a constant flow regardless of changes in load or pressure. For additional information see Technical Tips on pages FC1-FC4.

Features

- Hardened, precision ground parts for durability
- Stable and quiet response
- Contamination tolerant
- Standard valve bodies and common cavities
- Seal variations and other options available
- All external parts zinc plated

Performance Curve

Control ΔP (Through cartridge only)

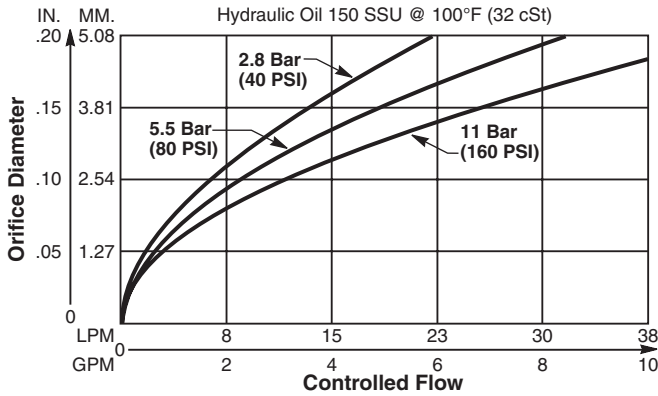

Specifications

Rated Flow	38 LPM (10 GPM)
Maximum Inlet Pressure	245 Bar (3500 PSI)
Accuracy (Fixed)	±10% Spring rating to 210 Bar (3000 PSI)
Adjustment Range	None
Cartridge Material	All parts steel. All operating parts hardened steel.
Operating Temp. Range/Seals	-40°C to +93.3°C (Nitrile) (-40°F to +200°F) -31.7°C to +121.1°C (Fluorocarbon) (-25°F to +250°F)
Fluid Compatibility/Viscosity	Mineral-based or synthetic with lubricating properties at viscosities of 45 to 2000 SSU (6 to 420 cSt)
Filtration	ISO Code 16/13, SAE Class 4 or better
Approx. Weight	.14 kg (0.3 lbs.)
Cavity	C10-3 (See BC Section for more details)
Form Tool	Rougher NFT10-3R Finisher NFT10-3F

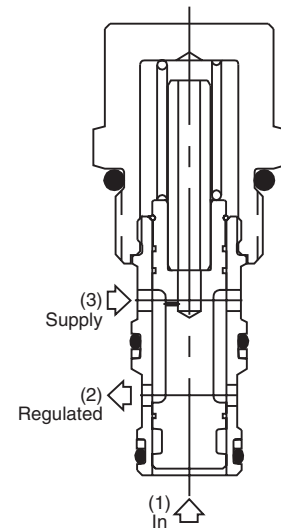
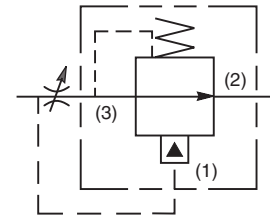
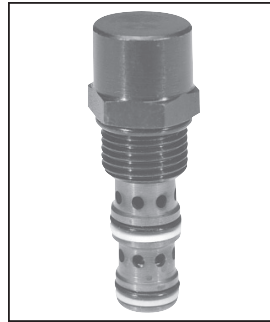

Dimensions Millimeters (Inches)

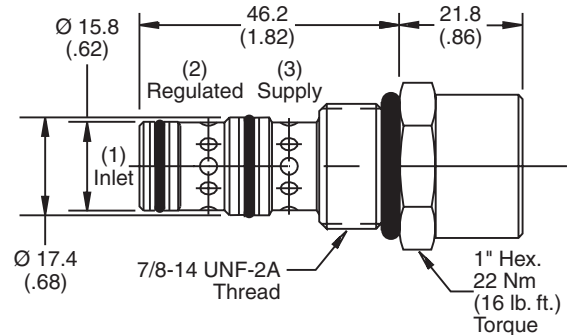

Ordering Information

FCR101F

10 Size Pressure Compensator Valve (Fixed Style) Pressure Differential Seals Body Material Port Size

Code	Press. Differential
Omit	11 Bar (160 PSI)
04	2.8 Bar (40 PSI)
08	5.5 Bar (80 PSI)

Code	Body Material
Omit	Steel
A	Aluminum

Code	Seals / Kit No.
Omit	Nitrile / (SK10-3N)
V	Fluorocarbon / (SK10-3V)

Code	Port Size	Body Part No.
Omit	Cartridge Only	
4P	1/4" NPTF	(B10-3-*4P)
6P	3/8" NPTF	(B10-3-*6P)
8P	1/2" NPTF	(B10-3-*8P)
6T	SAE-6	(B10-3-*6T)
8T	SAE-8	(B10-3-*8T)
6B	3/8" BSPG	(B10-3-6B)†
8B	1/2" BSPG	(B10-3-*8B)

* Add "A" for aluminum, omit for steel.
† Steel body only.



General Description

Restrictive Type Pressure Compensator. This valve is designed to be used in conjunction with an external orifice, fixed or variable, to provide a constant flow regardless of changes in load or pressure. For additional information see Technical Tips on pages FC1-FC4.

Features

- Hardened, precision ground parts for durability
- Stable and quiet response
- Contamination tolerant
- Standard valve bodies and common cavities
- Seal variations and other options available
- All external parts zinc plated

Performance Curve

Control ΔP (Through cartridge only)

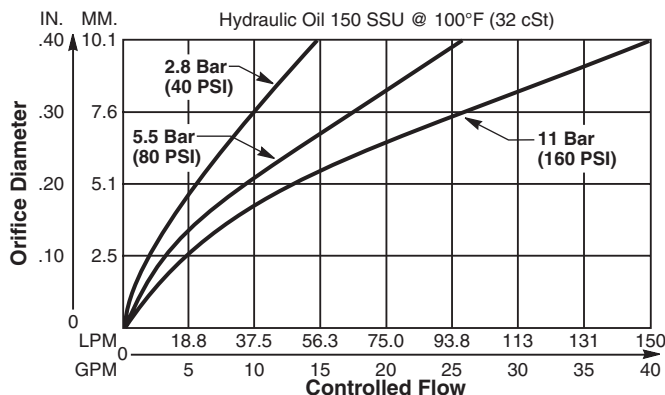

Specifications

Rated Flow	150 LPM (40 GPM)
Maximum Inlet Pressure	245 Bar (3500 PSI)
Accuracy (Fixed)	±10% Spring rating to 210 Bar (3000 PSI)
Adjustment Range	None
Cartridge Material	All parts steel. All operating parts hardened steel.
Operating Temp. Range/Seals	-40°C to +93.3°C (Nitrile) (-40°F to +200°F) -31.7°C to +121.1°C (Fluorocarbon) (-25°F to +250°F)
Fluid Compatibility/Viscosity	Mineral-based or synthetic with lubricating properties at viscosities of 45 to 2000 SSU (6 to 420 cSt)
Filtration	ISO Code 16/13, SAE Class 4 or better
Approx. Weight	.34 kg (.75 lbs.)
Cavity	C16-3 (See BC Section for more details)
Form Tool	Rougher NFT16-3R Finisher NFT16-3F

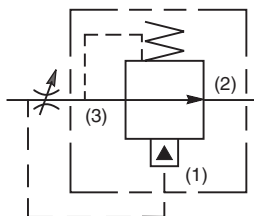
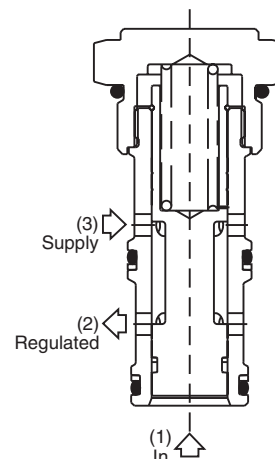
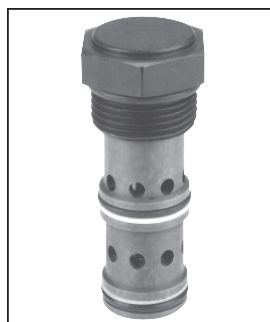

Dimensions

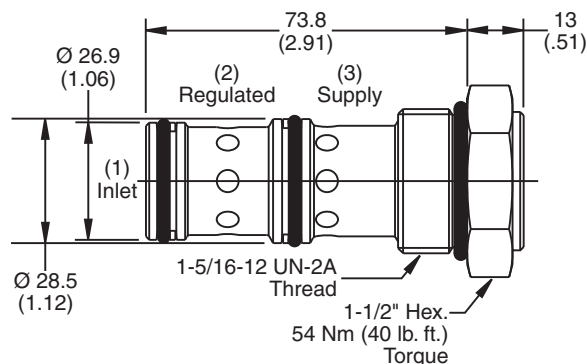

Ordering Information

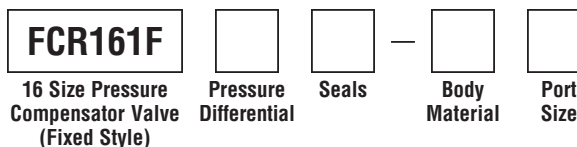

Code	Press. Differential
Omit	11 Bar (160 PSI)
04	2.8 Bar (40 PSI)

Code	Body Material
Omit	Steel
A	Aluminum

Code	Seals / Kit No.
Omit	Nitrile / (SK16-3)
V	Fluorocarbon / (SK16-3V)

Code	Port Size	Body Part No.
Omit	Cartridge Only	
12T	SAE-12	(B16-3-*12T)
16T	SAE-16	(B16-3-*16T)

* Add "A" for aluminum, omit for steel.

Technical Information

- CV** Check Valves
- SH** Shuttle Valves
- LM** Load/Motor Controls
- FC** Flow Controls
- PC** Pressure Controls
- LE** Logic Elements
- DC** Directional Controls
- MV** Manual Valves
- SV** Solenoid Valves
- PV** Proportional Valves
- CE** Coils & Electronics
- BC** Bodies & Cavities
- TD** Technical Data

General Description

Priority Type Pressure Compensator. This valve is designed to be used in conjunction with an external orifice (fixed or variable) to provide a constant flow to the priority port. Excess flow is bypassed through port 2. For additional information see Technical Tips on pages FC1-FC4.

Features

- Hardened, precision ground parts for durability
- Stable and quiet response
- Contamination tolerant
- Standard valve bodies and common cavities
- All external parts zinc plated

Performance Curve

Contol ΔP (Through cartridge only)

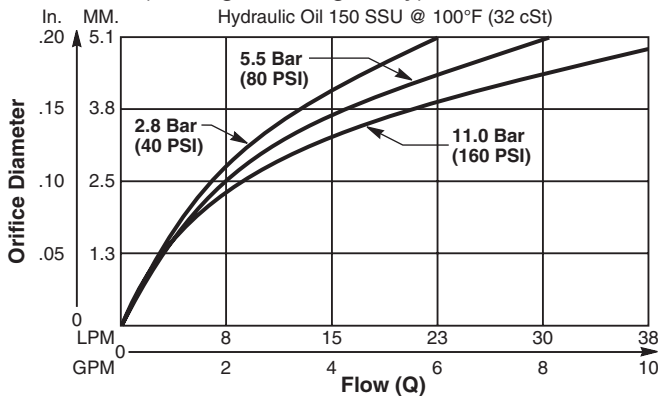

Specifications

Rated Flow	Inlet 56 LPM (15 GPM) Flow Setting 38 LPM (10 GPM)
Maximum Inlet Pressure	245 Bar (3500 PSI)
Accuracy (Fixed)	±10% Spring rating to 210 Bar (3000 PSI)
Adjustment Range	None
Cartridge Material	All parts steel. All operating parts hardened steel.
Operating Temp. Range/Seals	-40°C to +93.3°C (Nitrile) (-40°F to +200°F) -31.7°C to +121.1°C (Fluorocarbon) (-25°F to +250°F)
Fluid Compatibility/Viscosity	Mineral-based or synthetic with lubricating properties at viscosities of 45 to 2000 SSU (6 to 420 cSt)
Filtration	ISO Code 16/13, SAE Class 4 or better
Approx. Weight	.14 kg (0.3 lbs.)
Cavity	C10-4 (See BC Section for more details)
Form Tool	Rougher NFT10-4R Finisher NFT10-4F

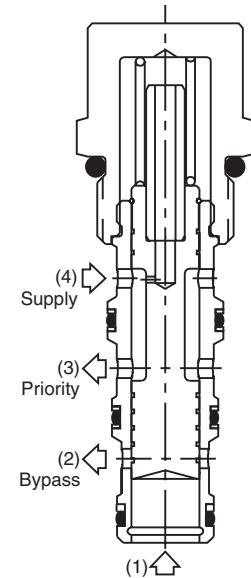
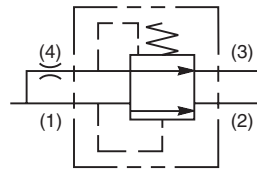
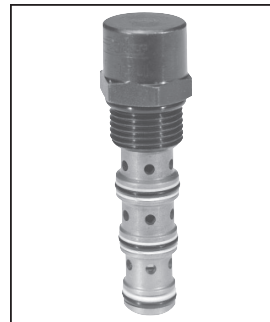

Dimensions Millimeters (Inches)

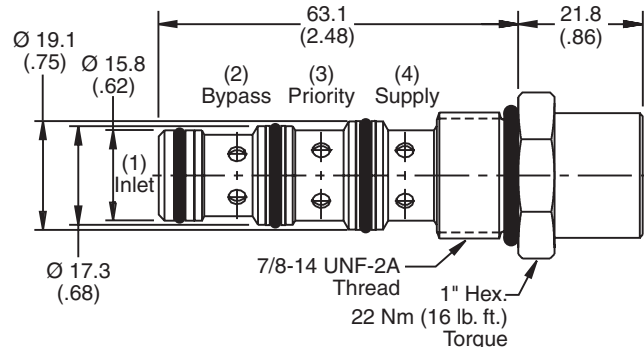

Ordering Information

FCP101F

10 Size Pressure Compensator Valve (Fixed Style) Pressure Differential Seals Body Material Port Size

Code	Press. Differential
Omit	11 Bar (160 PSI)
04	2.8 Bar (40 PSI)
08	5.5 Bar (80 PSI)

Code	Body Material
Omit	Steel
A	Aluminum

Code	Seals / Kit No.
Omit	Nitrile / (SK10-4N)
V	Fluorocarbon / (SK10-4V)

Code	Port Size	Body Part No.
Omit	Cartridge Only	
6P	3/8" NPTF	(B10-4-*6P)
6T	SAE-6	(B10-4-*6T)
8T	SAE-8	(B10-4-*8T)
6B	3/8" BSPG	(B10-4-6B)†

* Add "A" for aluminum, omit for steel.
† Steel body only.



Technical Information

- CV** Check Valves
- SH** Shuttle Valves
- LM** Load/Motor Controls
- FC** Flow Controls
- PC** Pressure Controls
- LE** Logic Elements
- DC** Directional Controls
- MV** Manual Valves
- SV** Solenoid Valves
- PV** Proportional Valves
- CE** Coils & Electronics
- BC** Bodies & Cavities
- TD** Technical Data

General Description

Priority Type Pressure Compensator. This valve is designed to be used in conjunction with an external orifice (fixed or variable) to provide a constant flow to the priority port. Excess flow is bypassed through port 2. For additional information see Technical Tips on pages FC1-FC4.

Features

- Hardened, precision ground parts for durability
- Stable and quiet response
- Contamination tolerant
- Standard valve bodies and common cavities
- Steel variations and other options available
- All external parts zinc plated

Specifications

Rated Flow	Inlet Flow Setting 95 LPM (25 GPM) 75 LPM (20 GPM)
Maximum Inlet Pressure	380 Bar (5500 PSI)
Cartridge Material	All parts steel. All operating parts hardened steel.
Operating Temp. Range/Seals	-40°C to +93.3°C (Nitrile) (-40°F to +200°F) -31.7°C to +121.1°C (Fluorocarbon) (-25°F to +250°F)
Fluid Compatibility/Viscosity	Mineral-based or synthetic with lubricating properties at viscosities of 45 to 2000 SSU (6 to 420 cSt)
Filtration	ISO Code 16/13, SAE Class 4 or better
Approx. Weight	.28 kg (.62 lbs.)
Cavity	C12-4 (See BC Section for more details)
Form Tool	Rougher NFT12-4R Finisher NFT12-4F

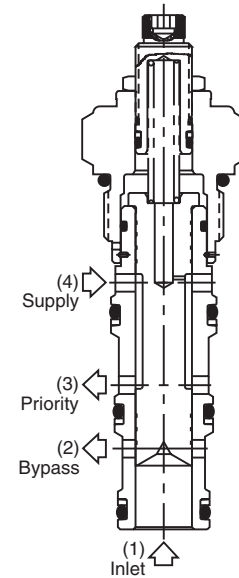
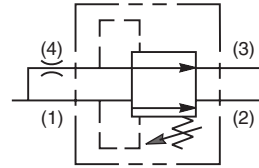

Performance Curve
Flow vs. Orifice Diameter
(Through cartridge only)

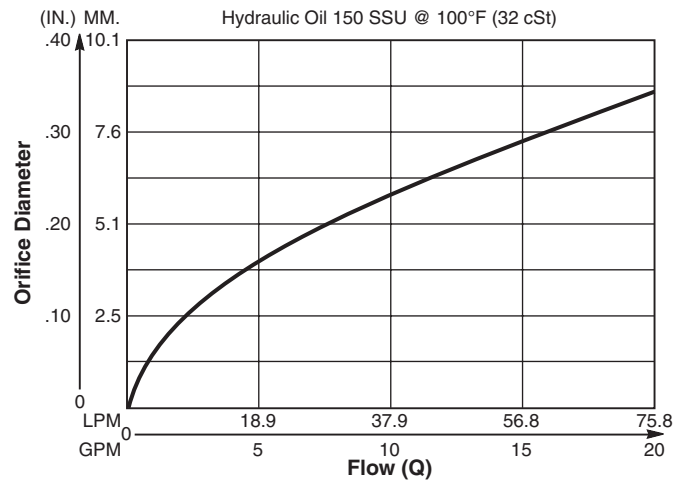

Dimensions Millimeters (Inches)

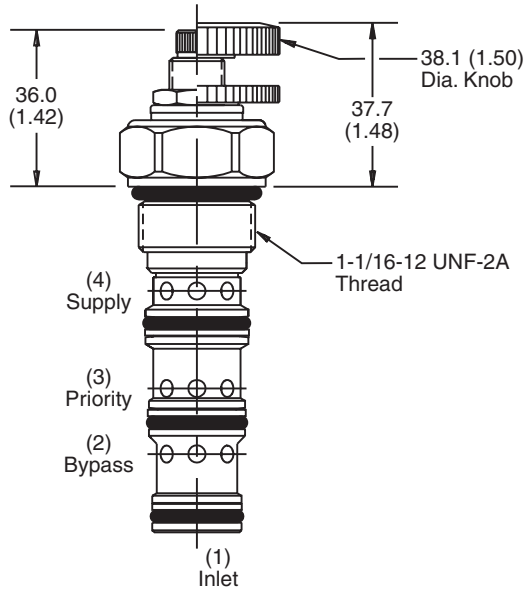

Screw/Knob Version

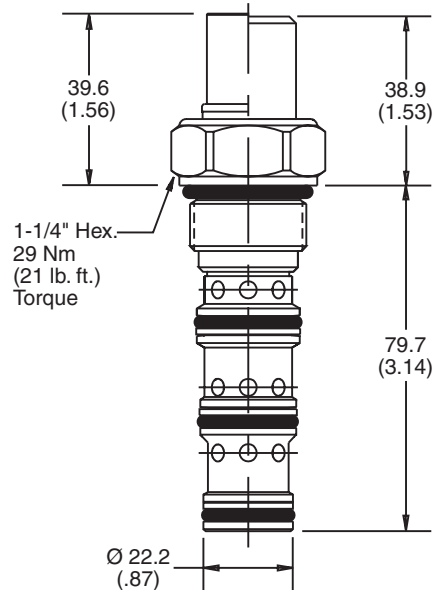

Fixed Cap/Tamper Resistant Version

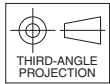

Ordering Information

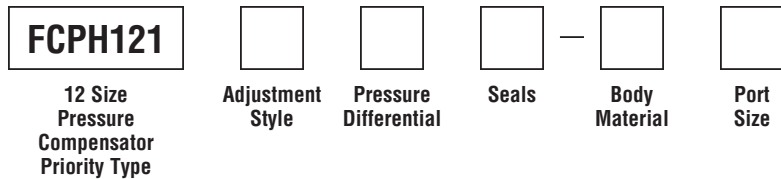

Code	Adjustment Style
F	Fixed style, present at factory
K	Knob Adjust (717784-15)
S	Screw Adjust
T	Tamper Resistant Cap (717785)

Code	Pressure Differential
Omit	11 Bar (160 PSI)

Code	Seals / Kit. No.
Omit	Nitrile / (SK12-4)
V	Fluorocarbon / (SK12-4V)

Code	Body Material
Omit	Steel
A	Aluminum

Code	Port Size	Body Part No.
Omit	Cartridge Only	
12T	SAE-12	(B12-4-*12T)

* Add "A" for aluminum, omit for steel.

- CV**
Check Valves
- SH**
Shuttle Valves
- LM**
Load/Motor Controls
- FC**
Flow Controls
- PC**
Pressure Controls
- LE**
Logic Elements
- DC**
Directional Controls
- MV**
Manual Valves
- SV**
Solenoid Valves
- PV**
Proportional Valves
- CE**
Coils & Electronics
- BC**
Bodies & Cavities
- TD**
Technical Data

Technical Information

- CV Check Valves
- SH Shuttle Valves
- LM Load/Motor Controls
- FC Flow Controls
- PC Pressure Controls
- LE Logic Elements
- DC Directional Controls
- MV Manual Valves
- SV Solenoid Valves
- PV Proportional Valves
- CE Coils & Electronics
- BC Bodies & Cavities
- TD Technical Data

General Description

Flow Divider/Combiner Valve. FDC101 divides flow from a single source proportionally to two actuators. In the reverse mode, flow from two sources is combined into one flow. When dividing or combining flow to synchronize two cylinders, please consider that the flow accuracy is $\pm 10\%$. For additional information see Technical Tips on pages FC1-FC4.

Features

- Hardened, precision ground parts for durability
- Cartridge design
- Ratios of 50-50, 60-40 and 66-33 available
- All external parts zinc plated

Specifications

Maximum Flow	45 LPM (12 GPM) See ordering information
Maximum Inlet Pressure	245 Bar (3500 PSI)
Accuracy	$\pm 10\%$
Cartridge Material	All parts steel. All operating parts hardened steel.
Operating Temp. Range (Ambient)	-40°C to +93.3°C (Nitrile) (-40°F to +200°F) -31.7°C to +121.1°C (Fluorocarbon) (-25°F to +250°F)
Filtration	ISO Code 16/13, SAE Class 4 or better
Fluids	Mineral-based or synthetic with lubricating properties at viscosities of 45 to 2000 SSU (6 to 420 cSt)
Approx. Weight	.14 kg (0.3 lbs.)
Cavity	No. C10-4
Form Tool	Rougher NFT10-4R Finisher NFT10-4F

Note: When machining a manifold using the FDC101, use C10-4 cavity. Do not machine a port that directs flow to the nose of the cavity.

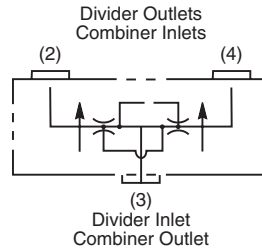
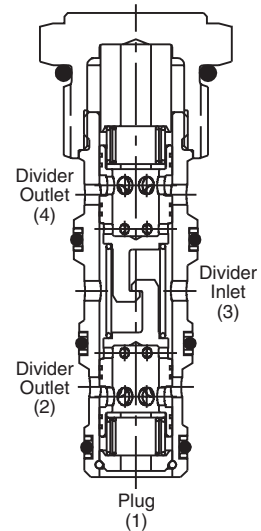
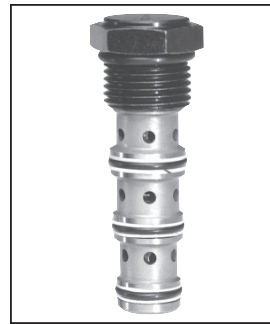

Performance Curve
Flow vs. Pressure Drop
(Through cartridge only)

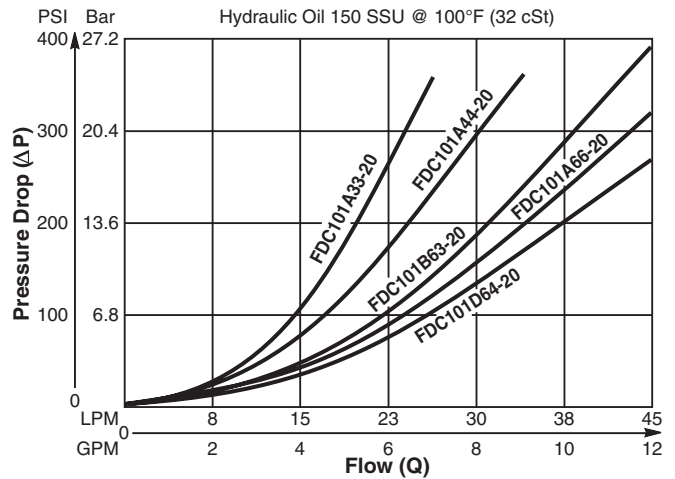

Dimensions Millimeters (Inches)

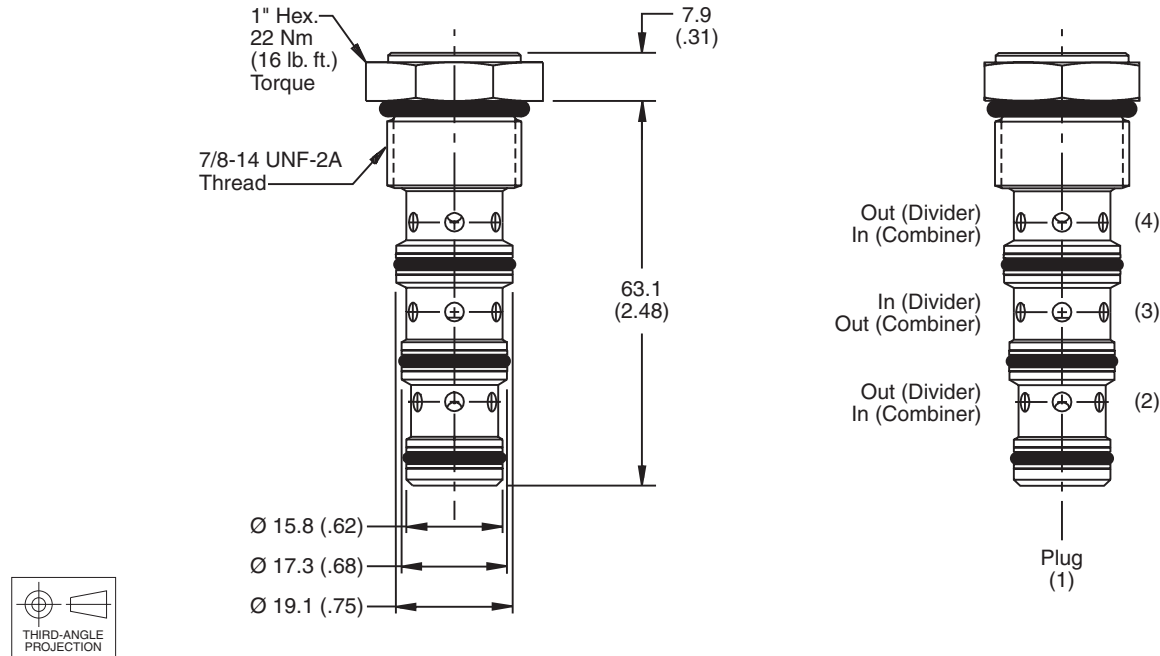

Ordering Information

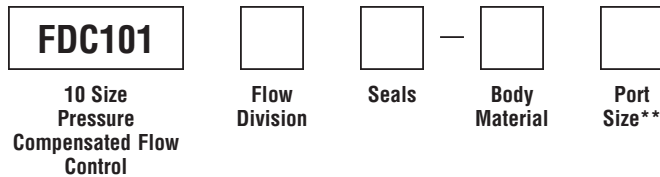

Code	Flow Division
A11	3.80 LPM (1 GPM) min. inlet 11.3 LPM (3 GPM) max. inlet 50% '4' Port and 50% '2' Port
A33	11.3 LPM (3 GPM) min. inlet 22.5 LPM (6 GPM) max. inlet 50% '4' Port and 50% '2' Port
A44	15.0 LPM (4 GPM) min. inlet 30.0 LPM (8 GPM) max. inlet 50% '4' Port and 50% '2' Port
A66	22.5 LPM (6 GPM) min. inlet 45.0 LPM (12 GPM) max. inlet 50% '4' Port and 50% '2' Port
B64	15.0 LPM (4 GPM) min. inlet 37.5 LPM (10 GPM) max. inlet 60% '4' Port and 40% '2' Port
D63	11.3 LPM (3 GPM) min. inlet 33.8 LPM (9 GPM) max. inlet 33% '4' Port and 66% '2' Port

Code	Seals / Kit. No.
Omit	Nitrile / (SK10-4N)
V	Fluorocarbon / (SK10-4V)

Code	Body Material
Omit	Steel
A	Aluminum

Code	Port Size	Body Part No.
Omit	Cartridge Only	
6P	3/8" NPTF	(B10-4-*6P)
6T	SAE-6	(B10-4-*6T)
8T	SAE-8	(B10-4-*8T)
6B	3/8" BSPG	(B10-4-6B)†

* Add "A" for aluminum, omit for steel.
 † Steel body only.

**The FDC101 cartridge has three ports. Due to its size, it requires a B10-4 series body. As a result, all cartridges in a body will be supplied with a plug located 180° from the cartridge cavity (port 1).

- B10-4-6T body — 6HP*50-S
- B10-4-8T body — 8HP*50-S
- B10-4-4P body — 102 x 4
- B10-4-6P body — 102 x 6
- B10-4-8P body — 102 x 8

When machining a manifold using the FDC101, use C10-4 cavity. Do not machine a port that directs flow to the nose of the cavity.

- CV**
Check Valves
- SH**
Shuttle Valves
- LM**
Load/Motor Controls
- FC**
Flow Controls
- PC**
Pressure Controls
- LE**
Logic Elements
- DC**
Directional Controls
- MV**
Manual Valves
- SV**
Solenoid Valves
- PV**
Proportional Valves
- CE**
Coils & Electronics
- BC**
Bodies & Cavities
- TD**
Technical Data

Technical Information

- CV** Check Valves
- SH** Shuttle Valves
- LM** Load/Motor Controls
- FC** Flow Controls
- PC** Pressure Controls
- LE** Logic Elements
- DC** Directional Controls
- MV** Manual Valves
- SV** Solenoid Valves
- PV** Proportional Valves
- CE** Coils & Electronics
- BC** Bodies & Cavities
- TD** Technical Data

General Description

Spool Type, Flow Divider/Combiner Valve. For additional information see Technical Tips on pages FC1-FC4.

Features

- Interlocking spools for equal control dividing or combining
- Range of flow settings available for optimising control
- Pressure compensated control in both directions
- 50/50 ratio standard, other ratios available on request
- Commonly used for differential lock in transmission applications
- Hardened working parts for maximum durability
- All external parts zinc plated

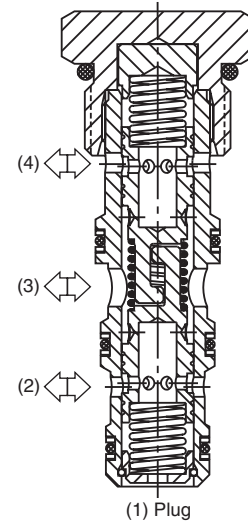
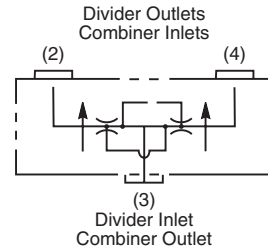
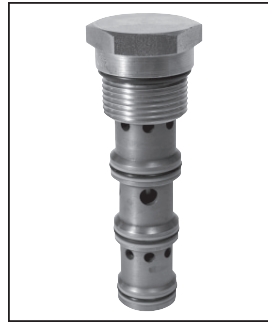

Specifications

Rated Flow	60 LPM (16 GPM)
Maximum Inlet Pressure	420 Bar (6000 PSI)
Flow Rating and Ratio	See Ordering Information
Accuracy Per Leg	± 10%
Cartridge Material	All parts steel. All operating parts hardened steel.
Operating Temp. Range/Seals	-40°C to +93.3°C (Nitrile) (-40°F to +200°F) -31.7°C to +121.1°C (Fluorocarbon) (-25°F to +250°F)
Fluid Compatibility/ Viscosity	Mineral-based or synthetic with lubricating properties at viscosities of 45 to 2000 SSU (6 to 420 cSt)
Filtration	ISO Code 16/13, SAE Class 4 or better
Approx. Weight	.12 kg (0.26 lbs.)
Cavity	C10-4 (See BC Section for more details)
Form Tool	Rougher NFT10-4R Finisher NFT10-4F

Performance Curve

Pressure Drop vs. Flow (Through cartridge only)

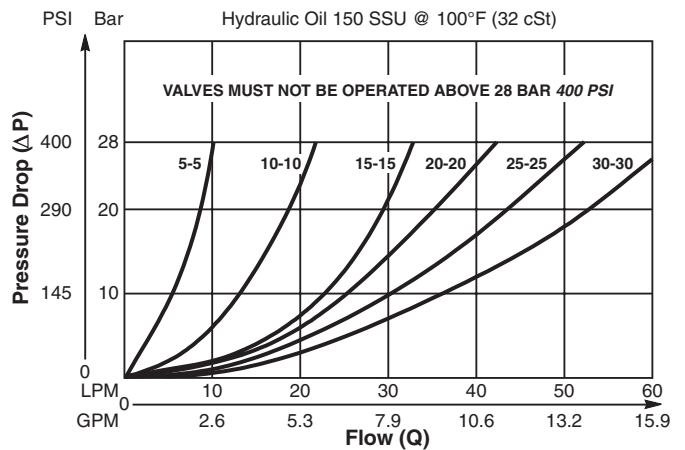

Dimensions Millimeters (Inches)

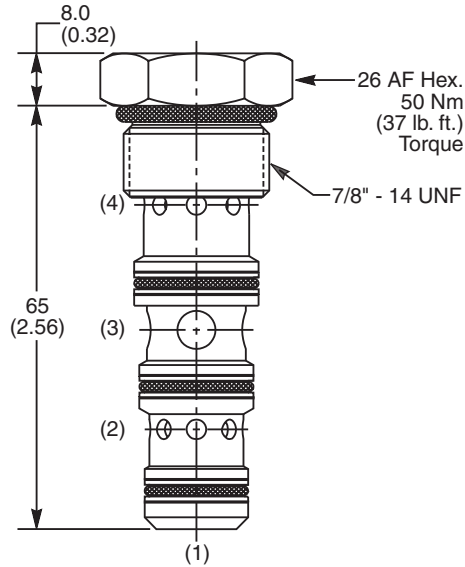

Ordering Information

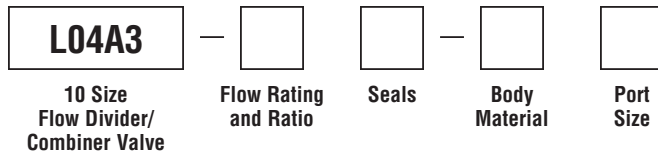

Code	Total Flow Rating - Port 2 (Flow Ratio)
5-5	6-10 LPM (1.6-2.6 GPM) (50/50 Ratio)
10-10	8-20 LPM (2.1-5.3 GPM) (50/50 Ratio)
15-15	10-30 LPM (2.6-7.9 GPM) (50/50 Ratio)
20-20	12-40 LPM (3.2-10.6 GPM) (50/50 Ratio)
25-25	13-50 LPM (3.4-13.2 GPM) (50/50 Ratio)
30-30	14-60 LPM (3.7-15.9 GPM) (50/50 Ratio)

Other ratios and ratings available on request.

Code	Seals / Kit. No.
N	Nitrile, Buna-N (Std.) / (SK30506N-1)
V	Fluorocarbon / (SK30506V-1)

Code	Body Material
Omit	Steel
A	Aluminum

Code	Port Size	Body Part No.
Omit	Cartridge Only	
6P	3/8" NTPF	(B10-4-*6P)
6T	SAE-6	(B10-4-*6T)
8T	SAE-8	(B10-4-*8T)
6B	3/8" BSPG	(B10-4-6B)†

** Add "A" for aluminum, omit for steel.
 † Steel bodies only*

Technical Information

- CV** Check Valves
- SH** Shuttle Valves
- LM** Load/Motor Controls
- FC** Flow Controls
- PC** Pressure Controls
- LE** Logic Elements
- DC** Directional Controls
- MV** Manual Valves
- SV** Solenoid Valves
- PV** Proportional Valves
- CE** Coils & Electronics
- BC** Bodies & Cavities
- TD** Technical Data

General Description

Spool Type, Flow Divider/Combiner Valve. For additional information see Technical Tips on pages FC1-FC4.

Features

- Interlocking spools for equal control dividing or combining
- Range of flow settings available for optimising control
- Pressure compensated control in both directions
- 50/50 ratio standard, other ratios available on request
- Commonly used for differential lock in transmission applications
- Hardened working parts for maximum durability
- All external parts zinc plated

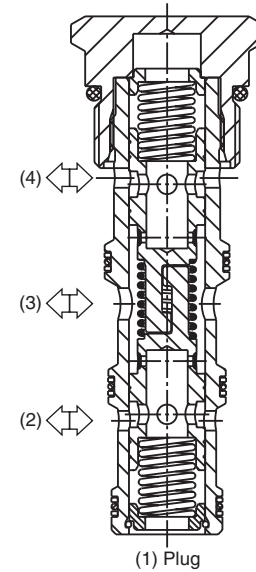
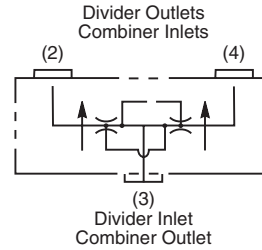
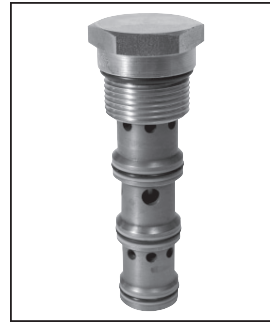

Specifications

Rated Flow	180 LPM (47 GPM)
Maximum Inlet Pressure	420 Bar (6000 PSI)
Flow Rating and Ratio	See Ordering Information
Accuracy Per Leg	± 10%
Cartridge Material	All parts steel. All operating parts hardened steel.
Operating Temp. Range/Seals	-40°C to +93.3°C (Nitrile) (-40°F to +200°F) -31.7°C to +121.1°C (Fluorocarbon) (-25°F to +250°F)
Fluid Compatibility/ Viscosity	Mineral-based or synthetic with lubricating properties at viscosities of 45 to 2000 SSU (6 to 420 cSt)
Filtration	ISO Code 16/13, SAE Class 4 or better
Approx. Weight	.40 kg (0.86 lbs.)
Cavity	C16-4 (See BC Section for more details)
Form Tool	Rougher Finisher

Performance Curve

Pressure Drop vs. Flow (Through cartridge only)

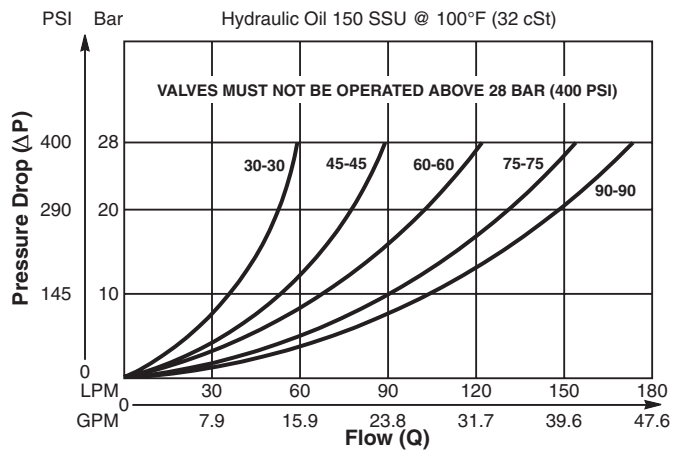

Dimensions Millimeters (Inches)

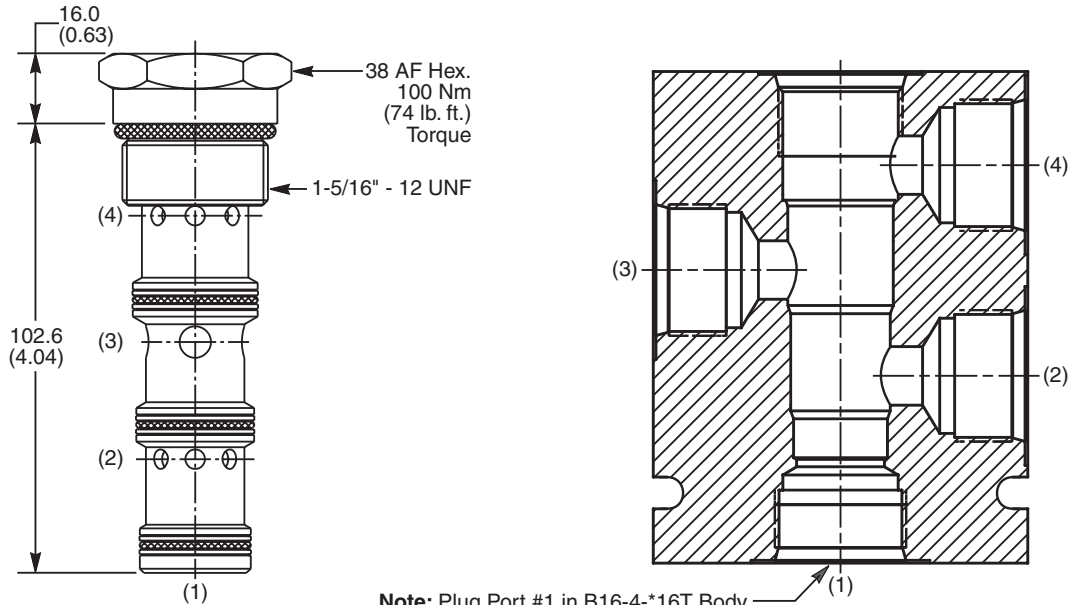

Note: Plug Port #1 in B16-4-*16T Body, use Parker #16HP50N-S Hollow Hex Plug.

Ordering Information

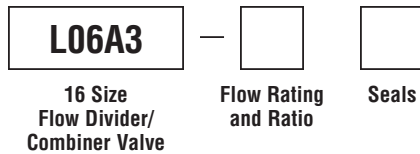

Code	Total Flow Rating - Port 2 (Flow Ratio)
30-30	20-60 LPM (5.3-15.9 GPM) (50/50 Ratio)
45-45	25-90 LPM (6.6-23.8 GPM) (50/50 Ratio)
60-60	35-120 LPM (9.2-31.7 GPM) (50/50 Ratio)
75-75	55-150 LPM (14.6-39.6 GPM) (50/50 Ratio)
90-90	65-180 LPM (17.2-47.8 GPM) (50/50 Ratio)

Other ratios and ratings available on request.

Code	Seals / Kit. No.
N	Nitrile, Buna-N (Std.) / (SK30510N-1)
V	Fluorocarbon / (SK30510V-1)

Order Bodies Separately

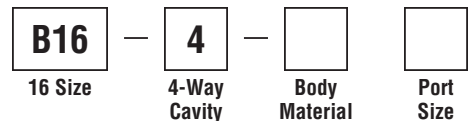

Code	Body Material
Omit	Steel
A	Aluminum

Code	Port Size	Body Part No.
Omit	Cartridge Only	
16T	SAE-16	(B16-4-*16T)

** Add "A" for aluminum, omit for steel.*

- CV**
Check Valves
- SH**
Shuttle Valves
- LM**
Load/Motor Controls
- FC**
Flow Controls
- PC**
Pressure Controls
- LE**
Logic Elements
- DC**
Directional Controls
- MV**
Manual Valves
- SV**
Solenoid Valves
- PV**
Proportional Valves
- CE**
Coils & Electronics
- BC**
Bodies & Cavities
- TD**
Technical Data

Technical Information

- CV** Check Valves
- SH** Shuttle Valves
- LM** Load/Motor Controls
- FC** Flow Controls
- PC** Pressure Controls
- LE** Logic Elements
- DC** Directional Controls
- MV** Manual Valves
- SV** Solenoid Valves
- PV** Proportional Valves
- CE** Coils & Electronics
- BC** Bodies & Cavities
- TD** Technical Data

General Description

Spool Type, Flow Divider/Combiner Valve. For additional information see Technical Tips on pages FC1-FC4.

Features

- Interlocking spools for equal control dividing or combining
- Range of flow settings available for optimising control
- Pressure compensated control in both directions
- 50/50 ratio standard, other ratios available on request
- Commonly used for differential lock in transmission applications
- Hardened working parts for maximum durability
- All external parts zinc plated

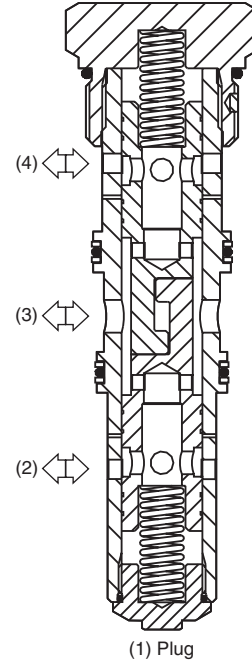
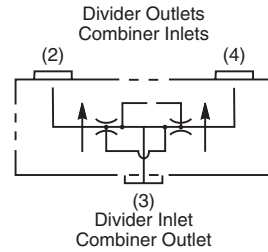
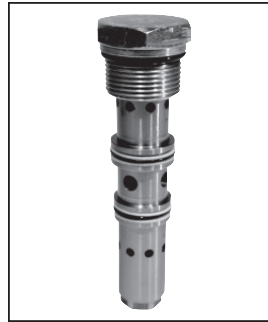

Specifications

Rated Flow	320 LPM (85 GPM)
Maximum Inlet Pressure	350 Bar (5000 PSI)
Flow Rating and Ratio	See Ordering Information
Accuracy Per Leg	± 10%
Cartridge Material	Steel operating parts, hardened steel poppet.
Operating Temp. Range/Seals	-40°C to +93.3°C (Nitrile) (-40°F to +200°F) -31.7°C to +121.1°C (Fluorocarbon) (-25°F to +250°F)
Fluid Compatibility/ Viscosity	Mineral-based or synthetic with lubricating properties at viscosities of 45 to 2000 SSU (6 to 420 cSt)
Filtration	ISO Code 16/13, SAE Class 4 or better
Approx. Weight	1.0 kg (2.2 lbs.)
Cavity	91-1 (See BC Section for more details)
Form Tool	Rougher Finisher

Performance Curve

Pressure Drop vs. Flow (Through cartridge only)

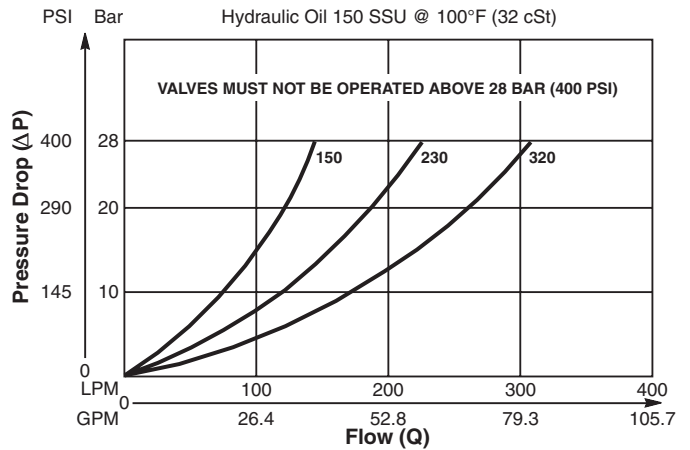

Dimensions Millimeters (Inches)

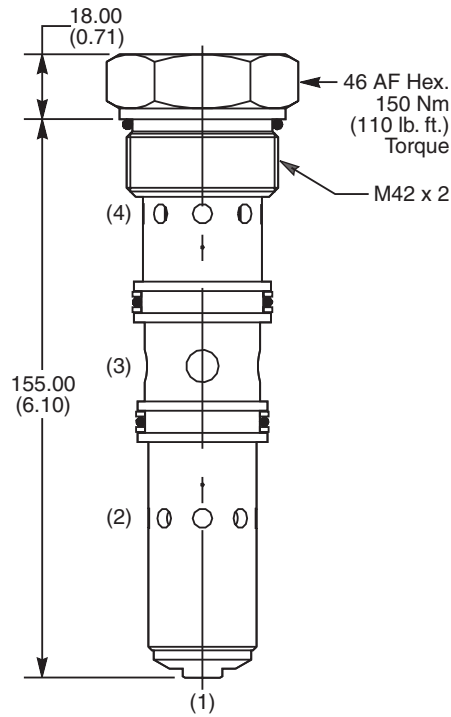

Ordering Information

L1A300	<input type="checkbox"/>	<input type="checkbox"/>	<input type="checkbox"/>
Flow Divider/ Combiner Valve	Flow Rating	Dividing/ Combiner Ratio	Seals

Code	Flow Rating
150	60-150 LPM (15.9-39.7 GPM)
230	75-230 LPM (19.8-60.8 GPM)
320	110-320 LPM (29.1-84.7 GPM)

Code	Seals / Kit. No.
N	Nitrile, Buna-N (Std.)/ (SK30050N-1)
V	Fluorocarbon / (SK30050V-1)

Code	Dividing/Combiner Ratio
5050	50 : 50 Ratio

Other ratios available on request.

Order Bodies Separately

LB10	<input type="checkbox"/>	<input type="checkbox"/>
Line Body	Porting	Body Material

Code	Porting
156	2 x 1" BSP 1 x 1-1/2" BSP
157	2 x 1" SAE 1 x 1-1/2" SAE

Code	Body Material
A	Aluminum
S	Steel

- CV**
Check Valves
- SH**
Shuttle Valves
- LM**
Load/Motor Controls
- FC**
Flow Controls
- PC**
Pressure Controls
- LE**
Logic Elements
- DC**
Directional Controls
- MV**
Manual Valves
- SV**
Solenoid Valves
- PV**
Proportional Valves
- CE**
Coils & Electronics
- BC**
Bodies & Cavities
- TD**
Technical Data