



# *Instrumentation and Gas Sampling Filters*

- Stainless steel, aluminum & plastic housings
- Clear bowls available
- Connections from 1/8" to 2" NPT
- Pressures to 5000 PSIG

*Bulletin 1300 - 694/USA*



# **Finite<sup>®</sup>**

# Finite®

## Instrumentation and Gas Sampling Filters

Finite's instrumentation and point-of-use product line offers compressed air/gas filtration solutions for food processing, medical, chemical processing, and compressed natural gas applications.

Typical installations include contaminant removal for breathing air, protection of gas analyzers and prefilters for instrument air dryers.



Our UNI-CAST element technology allows us to vacuum form high-efficiency particulate and coalescing filter elements. Our elements are designed with high void

volumes to provide longer element life while yielding lower pressure drops.

---

Made directly from the highest quality microglass fibers available, Finite's elements are constructed in 5 porosity grades and 9 media types to meet nearly all compressed air/gas applications.

---

Finite's instrumentation filter housings are carefully engineered to meet critical application specifications. A complete line of stainless steel housings are available with a variety of pressure ratings

and flows for corrosive applications. Combination aluminum head/nylon bowl assemblies are offered for lower operating pressures and temperatures, while disposable plastic in-lines are offered for low flow and OEM applications.

If you have a specific need or are unable to find the compressed air/gas filter your application requires, call us!

Let one of Finite's application engineers assist you! Visit us on the web at [www.parker.com/finitefilter](http://www.parker.com/finitefilter) or call us toll-free 1-800-521-4357 and ask for technical support.

## How to select your Finite® Filter...

The following steps will help you to choose the correct filter for your application. If there are other factors involved or if you have special requirements, call Finite's technical support.

1. Evaluate the requirements of your application. The sketches on page 3 depict popular Examples of gas sampling, process filtration, instrument air and breathing air applications.
2. What type of filtration is needed? (See pages 4-5) Coalescing filter medias remove solid and liquid contaminants from gas streams. Particulate filter media removes solids from gas streams. Adsorber media removes hydrocarbon vapors from gas streams.
3. Are you searching for a specific micron rating ... or efficiency rating? If so, page 5 provides a complete breakdown of Finite's filter media grades and their performance specifications.
4. What are the operating conditions of your application? Key criteria to consider: flow, pressure, materials of construction ... stainless steel, nylon, aluminum, etc. Pages 6-12 provide detailed descriptions of the various products available.
5. Sizing - The flow chart on pages 13-14 lists the flow rates (SCFM) at various operating pressures. Filters are available with flows up to 3366 SCFM and pressure ratings up to 5000 PSIG.



# Finite® Instrumentation Applications

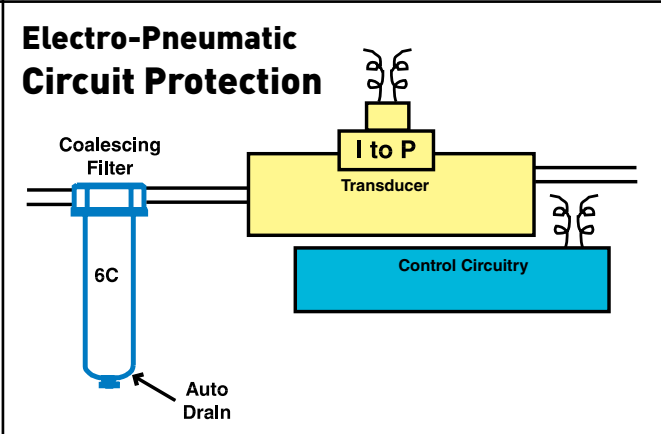
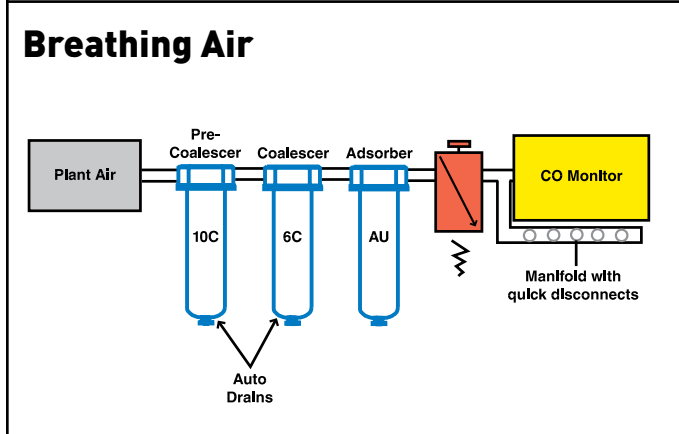
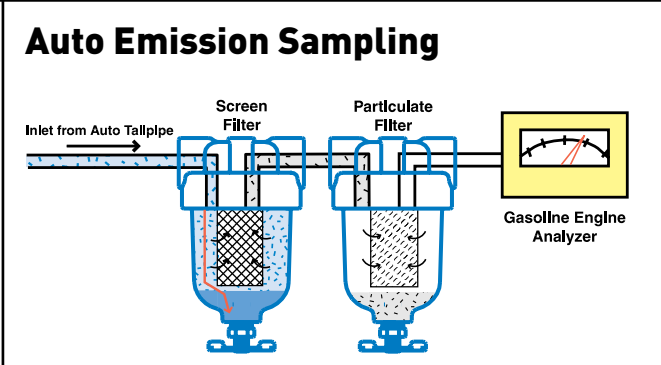
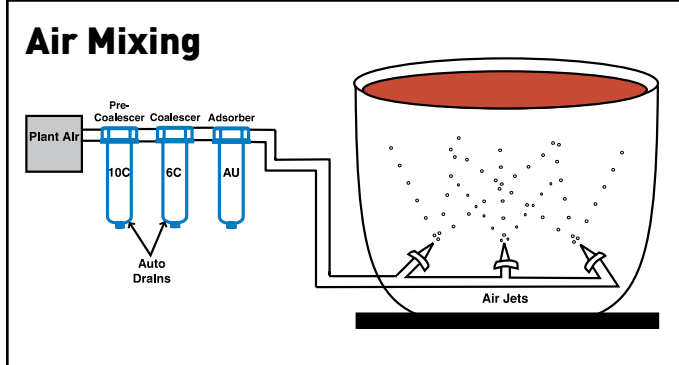
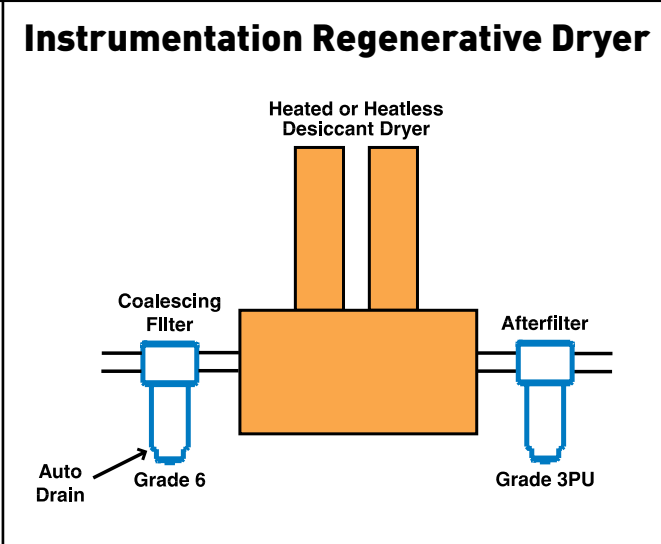
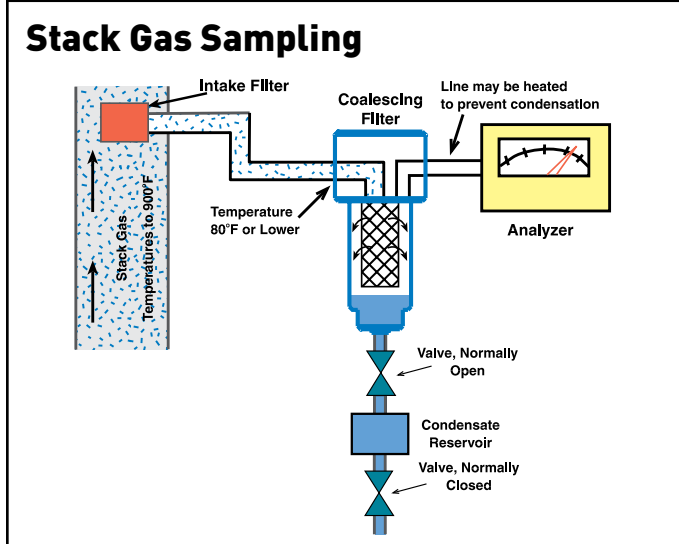
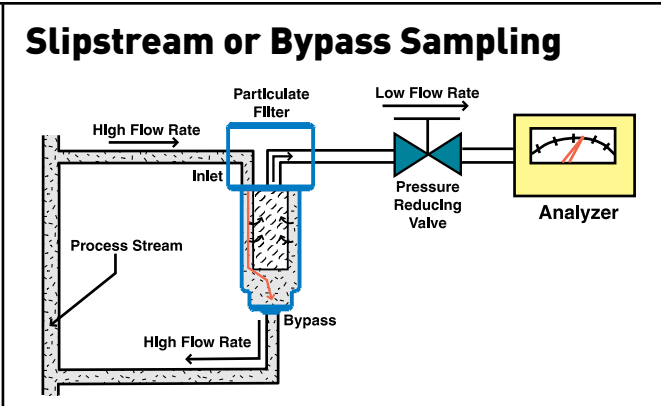
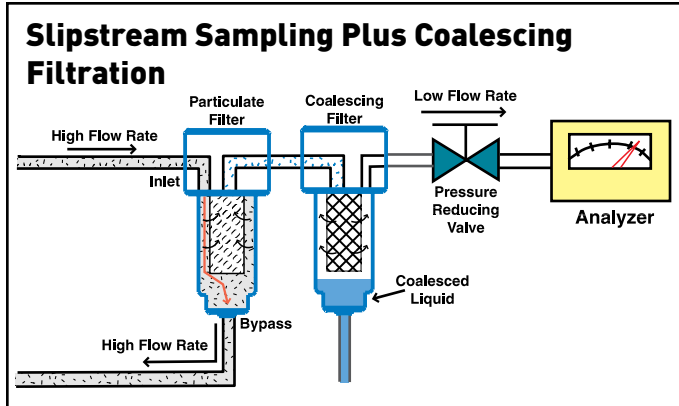

# Finite Media Types, Grades and Efficiencies

## Coalescing elements:

Coalescing elements are specially designed for the removal of liquid contaminants from gaseous flows. These media types flow from the inside of the element to the outside. Coalesced liquid (water and oil) collects in the bowl where it is drained, while clean air or gas exits the housing through the outlet port. Particulate contaminants are captured and held in the media.



### Type C

Coalescing element composed of an epoxy saturated, borosilicate glass microfiber tube in intimate interlocking contact with a rigid retainer. Surrounded by a coarse fiber drain layer, retained by a synthetic fabric safety layer. Some models are available with molded elastomeric end seals (CU), or with metal end caps and fluorocarbon gaskets.



### Type H

Coalescing element similar to type "C," however no rigid retainer is used. Typically used in applications with low or constant flow rates.



### Type Q

Coalescing element with the same configuration as "C" tube, but with "3P" type pleated cellulose prefilter built-in. Includes molded elastomeric end seals (QU). Some models offer the option of metal end caps and fluorocarbon gaskets.



### Type 7CVP

Coalescing element made of pleated glass media. Metal retained for added strength. Includes metal end caps and fluorocarbon gaskets for proper sealing. Only available in grade 7.

## Water Separator element:



### Type 100WS

This all stainless steel element has two metal retainers with rolled mesh screen in between. This cleanable element combines liquid droplets and aerosols, separating the liquids from the gas stream in systems with high liquid loads.

### Grade 4

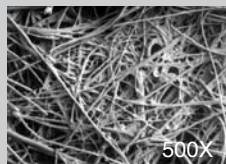

Grade 4 filter elements are very high efficiency coalescers; for elevated pressures or lighter weight gases. Recommended when system pressure exceeds 500 PSIG.

### Grade 6

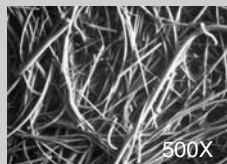

Grade 6 filter elements are used when "total removal of liquid aerosols and suspended fines" is required. **Because of its overall performance characteristics, this grade is most often recommended below 500 PSIG.**

### Grade 7CVP

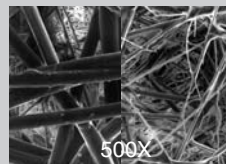

Grade 7CVP filter elements are made with two layers. The inner layer (left) effectively traps dirt particles, protecting and extending the life of the outer layer. The coalescing outer layer (right) consists of a dense matrix of glass fibers, providing highly efficient aerosol removal.

### Grade 8

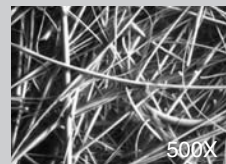

Grade 8 filter elements provide high efficiency filtration in combination with high flow rate and long element life.

### Grade 10

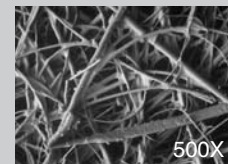

Grade 10 filters are used as prefilters for grade 6 to remove gross amounts of aerosols or tenacious aerosols which are difficult to drain. This grade is often used as a 'coarse' coalescer.

## Media Grades:



## Adsorption elements:

Adsorption elements are used to remove vapors (hydrocarbon or water) that are not removed by the coalescing filter. Hydrocarbon vapors collect in the element, while clean air exits the housing through the outlet port. In this element, the air or gas flows from the outside of the element to the inside.



Type A

Hydrocarbon vapor removal element. Ultrafine grained, highly concentrated, activated carbon sheet media. Includes molded elastomeric end seals (AU). Some models offer the option of metal end caps and fluorocarbon gaskets.

## Particulate elements:

Particulate filters such as G, F, T and 3P flow from the outside of the element to the inside. Particles collect in the element, while the clean air exits through the outlet port.



Type 3P

Pleated cellulose particulate removal element. Includes molded elastomeric end seals (3PU). Some models offer the option of metal end caps and fluorocarbon gaskets.



Type G

Particulate removal element constructed of the same fiber matrix as type "C", but with no rigid retainer or drain layer.

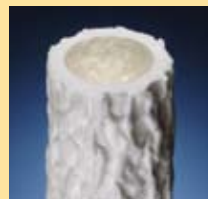

Type F

Particulate removal element like "G" tube, except fluorocarbon saturant replaces epoxy.



Type T

Particulate removal element like "G" tube, except high temperature fluorocarbon saturant replaces epoxy.

## Finite® media grades and specifications

Finite media grades determine the filtration efficiency. Capture efficiencies are available up to 99.999%. Micron ratings range from 0.01 to 3 micron. The columns on the right note both the wet and dry pressure drops.

Media Grade	Coalescing Efficiency 0.3 to 0.6 Micron Particles	Coalescing Filters - C, H, Q, 7CVP Maximum Oil Carryover <sup>1</sup> PPM w/w	Particulate Filters - 3P, G, F, T Micron Rating	Pressure Drop (PSID) @ Rate Flow <sup>2</sup>	
				Media Dry	Media Wet With 10-20 wt. oil
4	99.995%	0.003	0.01	1.25	3-4
6	99.97%	0.008	0.01	1.0	2-3
7CVP	99.5%	0.09	0.5	0.25	0.5-0.7
8	98.5%	0.2	0.5	0.5	1-1.5
10	95%	0.85	1.0	0.5	0.5
100WS	N/A	N/A	100 Nominal	<0.25	0.25
3P	N/A	N/A	3.0	0.25	N/A
A	99% <sup>3</sup>	N/A	3 Nominal	1.0	N/A

<sup>1</sup>Tested per ADF-400 at 40 ppm inlet.

<sup>2</sup>Add dry + wet for total pressure drop.

<sup>3</sup>Oil vapor removal efficiency is given for A media

Grade 3P



Three micron pleated cellulose filters are used for particulate interception where very high dirt holding capacity and a relatively fine pore structure are required.

Grade A



A (Adsorption) filters are used to remove hydrocarbon vapor, most typically in preparation for breathing air. (Must be preceded by grade 6C coalescer.)

# Bypass or High Pressure Filters

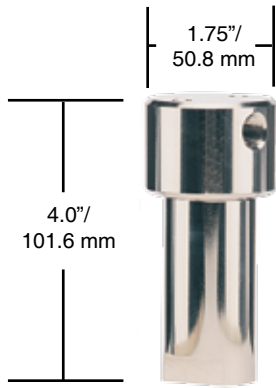

**Application:** Finite's high pressure filters are available with housings made of 316 stainless steel (S5R,S1R) or aluminum (A5R, A1R). This series is used for gas bypass sampling, high pressure compressed natural gas filtration, and applications with elevated pressures and corrosion resistance requirements. High efficiency particulate and coalescing elements are available with these units. Includes drain port with plug. Connection size of drain port matches inlet and outlet connection size.

How to Order:

<input type="checkbox"/>	<input type="checkbox"/>	<input checked="" type="checkbox"/>	—	<input type="checkbox"/>	<input type="checkbox"/>	<b>04-023</b>
<u>Materials</u>	<u>Port Size</u>			<u>Media Grade</u>	<u>Media Type</u>	<u>Element Size</u>
A = Aluminum	5 = 1/8" NPT 1 = 1/4" NPT			4 6 8 10	G T F H C	
S = 316 Stainless Steel						

For Example: S1R-6C04-023 for complete assembly, including element. S1R X 1 for an empty housing.

# S1IL Stainless Steel Particulate Filters

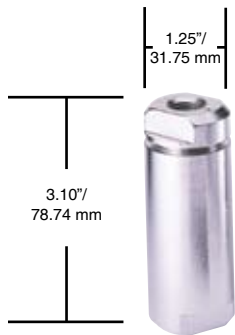

**Application:** The S1IL filter is typically applied for the particulate filtration of bottled gas or as a last chance filter where there is limited space availability. It does not have a drain port and should only be used when little or no liquid contaminant is expected.

How to Order:

<input checked="" type="checkbox"/>	<input checked="" type="checkbox"/>	<input checked="" type="checkbox"/>	—	<input type="checkbox"/>	<input type="checkbox"/>	<b>04-013</b>
				<u>Media Grade</u>	<u>Media Type</u>	<u>Element Size</u>
				4 6 8 10	G T F	

For Example: S1IL-8T04-013 for complete assembly, including element. S1IL X 1 for an empty housing.

## Specifications:

Model Number	Port Size (NPT)	Max. Pressure	Max. Temp. (Element Type)	Materials of Construction			Seals	Shipping Weight
				Head	Internals	Bowl		
S5R,S1R	1/8",1/4"	5000 PSIG/ 345 bar	450°F (T) 350°F(G, C, H) 275°F(F)	316 Stainless Steel	316 Stainless Steel	316 Stainless Steel	Fluorocarbon	1.16 lbs./ .53 kgs.
A5R,A1R	1/8",1/4"	1000 PSIG/ 68 bar	225°F (All media types)	Aluminum	316 Stainless Steel	Aluminum	Buna-N	.75 lbs./ .34 kgs.
S1IL	1/4"	5000 PSIG/ 345 bar	450°F (T) 350°F(G) 275°F(F)	316 Stainless Steel	316 Stainless Steel	316 Stainless Steel	Fluorocarbon	.75 lbs./ .34 kgs.

# Small Internal Volume Filters With Glass Bowl



**Application:** These filters are used for gas analyzer protection and corrosive applications where element visibility is required. These housings have smaller internal volumes which allow for quicker evacuation and faster sampling times. Includes 1/4" NPT drain port with plug.

How to Order:

<input type="checkbox"/> S	<input type="checkbox"/>	<input type="checkbox"/> P	<input type="checkbox"/>	—	<input type="checkbox"/>	<input type="checkbox"/>	<input type="checkbox"/>
<u>Port Size</u>			<u>Bowl Length</u>		<u>Media Grade</u>	<u>Media Type</u>	<u>Element Size</u>
1 = 1/4" NPT			S = Short		4	G	10-025 = short bowl
2 = 1/2" NPT			L = Long		6	T	10-070 = long
					8	F	
					10	H	

For Example: S1PL-10T10-070 for complete assembly, including element.  
S1PL X 1 for an empty housing.

# Small Internal Volume Filters With Stainless Bowl



**Application:** These filters have similar applications as filter above, however this version has a stainless steel bowl which allows for higher pressure and temperature applications. Includes 1/4" NPT drain port with plug.

How to Order:

<input type="checkbox"/> S	<input type="checkbox"/>	<input type="checkbox"/> S	<input type="checkbox"/>	—	<input type="checkbox"/>	<input type="checkbox"/>	<input type="checkbox"/>
<u>Port Size</u>			<u>Bowl Length</u>		<u>Media Grade</u>	<u>Media Type</u>	<u>Element Size</u>
1 = 1/4" NPT			S = Short		4	G	10-025 = short bowl
2 = 1/2" NPT			L = Long		6	T	10-070 = long
					8	F	
					10	H	

For Example: S2SS-10G10-025 for complete assembly, including element.  
S2SS X 1 for an empty housing.

## Specifications:

Model Number	Port Size (NPT)	Max. Pressure	Max. Temp. (Element Type)	Materials of Construction			Seals	Shipping Weight
				Head	Internals	Bowl		
S1PS,S2PS	1/4", 1/2"	100 PSIG/ 7 bar	160°F (All media types)	316 Stainless Steel	316 Stainless Steel	Heat Resistant Borosilicate Glass	Fluorocarbon	2 lbs./0.91 kgs.
S1PL,S2PL	1/4", 1/2"	100 PSIG/ 7 bar	160°F (All media types)	316 Stainless Steel	316 Stainless Steel	Heat Resistant Borosilicate Glass	Fluorocarbon	4 lbs./1.81 kgs.
S1SS,S2SS	1/4", 1/2"	425 PSIG/ 29 bar	400°F (T) 350°F (G,H) 275°F (F)	316 Stainless Steel	316 Stainless Steel	316 Stainless Steel	Fluorocarbon	3 lbs./1.4 kgs.
S1SL,S2SL	1/4", 1/2"	250 PSIG/ 17 bar	400°F (T) 350°F (G,H) 275°F (F)	316 Stainless Steel	316 Stainless Steel	316 Stainless Steel	Fluorocarbon	5 lbs./2.3 kgs.

# S3C/S4C Stainless Steel Filters

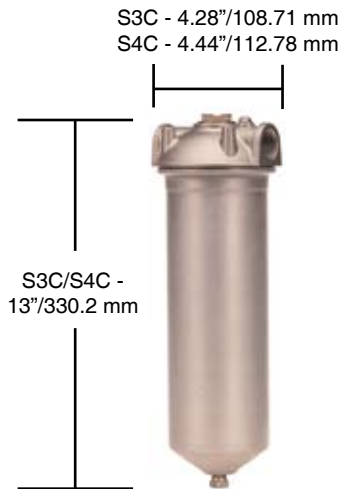

**Application:** Finite's S3C and S4C units are economical stainless steel filter assemblies for applications in food processing, pharmaceutical, and chemical manufacturing. Coalescing, particulate and adsorptive filters are available. Includes 1/4" NPT drain port with plug.

How to Order:

<input type="checkbox"/> S	<input type="checkbox"/>	<input type="checkbox"/> C	—	<input type="checkbox"/>	<input type="checkbox"/>	<input type="checkbox"/> 13-087
	<u>Port Size</u>			<u>Media Grade</u>	<u>Media Type</u>	<u>Element Size</u>
	3 = 3/4" NPT			blank for 3PU, AU	CU	
	4 = 1" NPT			4	3PU	
				6	AU	
				8		
				10		

For Example: S3C-6CU13-087 for complete assembly, including element.  
S3C X 1 for an empty housing.

# High Flow Stainless Steel Filter



**Application:** Finite's 2" NPT stainless steel filter is the right solution for most critical or corrosive compressed air/gas applications. Its 500 PSIG design pressure makes this an ideal choice for higher pressure applications. Bulk liquid separating, coalescing, particulate and adsorptive filters are available. Includes 1/4" NPT drain port with plug.

How to Order:

S  N  8  S x  1

For Example: SN8S X 1

Elements sold separately: \*CU, 3PU, AU, 7CVP and 100WS (Bulk Liquid Separator)  
Element size is 24-187.

\* insert grade: 4, 6, 8, 10

For Example: 6CU24-187 X 1

## Specifications:

Model Number	Port Size (NPT)	Max. Pressure	Max. Temp (Element Type)	Materials of Construction			Seals	Shipping Weight
				Head	Internals	Bowl		
S3C,S4C	3/4", 1"	150 PSIG/ 10 bar	175°F (All media types)	316 Stainless Steel	316 Stainless Steel	316 Stainless Steel	Fluorocarbon	5.2 lbs./2.4 kgs.
SN8S	2"	500 PSIG/ 34 bar	175°F (All media types)	316 Stainless Steel	316 Stainless Steel	316 Stainless Steel	Fluorocarbon	32 lbs./14.4 kgs.



# Aluminum Filters with Clear Bowl

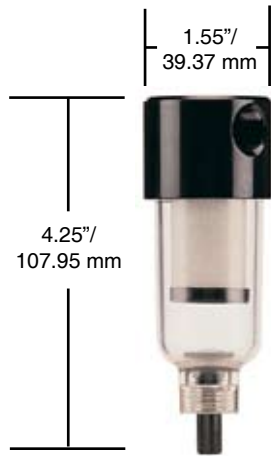

**Application:** The Q1S, Q5S series filters are an excellent choice for instrumentation and point-of-use general air system filtration. They also provide coalescing and adsorption filtration for robotic and OEM machine manufacturers. A manual twist drain is standard. An auto drain option is available.

How to Order:

<input type="checkbox"/>	<input checked="" type="checkbox"/> Q	<input type="checkbox"/>	<input checked="" type="checkbox"/> S	—	<input type="checkbox"/>	<input type="checkbox"/>	<b>06-013</b>
<u>Drain Option</u>		<u>Port Size</u>			<u>Media Grade</u>	<u>Media Type</u>	<u>Element Size</u>
blank for manual twist drain		5 = 1/8" NPT 1 = 1/4" NPT			blank for AM	HM AM	
A = Auto Drain F = 1/8" ID Hose Barb V = Needle Valve					4 6 8 10		

For Example: Q1S-AM06-013 for complete assembly, including element.  
Q1S X 1 for an empty housing.

# Aluminum Filters with Metal Bowl



**Application:** These aluminum filters are an excellent choice for instrumentation and point-of-use general air system filtration. The zinc bowl is preferred in higher temperature and pressure applications. They also provide coalescing and adsorption filtration for robotic and OEM machine manufacturers. A manual twist drain is standard. An auto drain option is available.

How to Order:

<input type="checkbox"/>	<input checked="" type="checkbox"/> H	<input type="checkbox"/>	<input checked="" type="checkbox"/> S	—	<input type="checkbox"/>	<input type="checkbox"/>	<b>06-013</b>
<u>Drain Option</u>		<u>Port Size</u>			<u>Media Grade</u>	<u>Media Type</u>	<u>Element Size</u>
blank for manual twist drain		5 = 1/8" NPT 1 = 1/4" NPT			blank for AM	HM AM	
A = Auto Drain F = 1/8" ID Hose Barb V = Needle Valve					4 6 8 10		

For Example: H5S-6HM06-013 for complete assembly, including element.  
H5S X 1 for an empty housing.

## Specifications:

Model Number	Port Size (NPT)	Max. Pressure	Max. Temp. (Element Type)	Materials of Construction			Seals	Shipping Weight
				Head	Internals	Bowl		
Q5S, Q1S	1/8", 1/4"	150 PSIG/ 10 bar	125°F (All media types)	Aluminum	N/A	Poly-carbonate	Buna N	.2 lbs./ .10 kgs.
H5S, H1S	1/8", 1/4"	250 PSIG/ 17 bar	175°F (All media types)	Aluminum	N/A	Zinc	Buna N	.3 lbs./ .14 kgs.

# Compact Nylon Filter With Clear Bowl



**Application:** KN1S and KN5S filters are an economical way to provide high-efficiency filtration for protection of emission analyzers, air-logic systems and low-flow point-of-use pneumatic components. Includes manual, tee-valve drain. (1/8" NPT port)

How to Order:

<input type="checkbox"/> <b>KN</b>	<input type="checkbox"/>	<input type="checkbox"/> <b>1</b>	—	<input type="checkbox"/>	<input type="checkbox"/>	<input type="checkbox"/> <b>06-016</b>
	<u>Port Size</u>			<u>Media Grade</u>	<u>Media Type</u>	<u>Element Size</u>
	5 = 1/8" NPT			blank for 75P	<b>G</b>	
	1 = 1/4" NPT			<b>4</b>	<b>T</b>	
				<b>6</b>	<b>F</b>	
				<b>8</b>	<b>H</b>	
				<b>10</b>	<b>C</b>	
					<b>75P</b>	

Note: The 75P Media Type is a 75 micron plastic filter element.

For Example: KN1S-6C06-016 for complete assembly, including element.  
KN1S X 1 for an empty housing.

# Nylon Filter With Clear Bowl



**Application:** The P1N offers economical high efficiency filtration for point-of-use, instrument systems or OEM circuit protection. The P1N is also used when sump and element visibility are required. Includes manual twist drain.

How to Order:

<input type="checkbox"/> <b>P</b>	<input type="checkbox"/> <b>1</b>	<input type="checkbox"/> <b>N</b>	—	<input type="checkbox"/>	<input type="checkbox"/>	<input type="checkbox"/> <b>10-025</b>
				<u>Media Grade</u>	<u>Media Type</u>	<u>Element Size</u>
				Leave blank for 3PU and AU	<b>G</b>	
				<b>4</b>	<b>T</b>	
				<b>6</b>	<b>F</b>	
				<b>8</b>	<b>H</b>	
				<b>10</b>	<b>C</b>	
					<b>CU</b>	
					<b>QU</b>	
					<b>3PU</b>	
					<b>AU</b>	

For Example: P1N-4QU10-025 for complete assembly, including element.  
P1N X 1 for an empty housing.

## Specifications:

Model Number	Port Size (NPT)	Max. Pressure	Max. Temp. (Element Type)	Materials of Construction			Seals	Shipping Weight
				Head	Internals	Bowl		
KN5S,KN1S	1/8",1/4"	150 PSIG/ 10 bar	125°F (All media types)	Glass Filled Nylon	Acetal Plastic, Steel	Clear Polyurethane	Buna N	.3 lbs./14 kgs.
P1N	1/4"	100 PSIG/ 7 bar	125°F (All media types)	Acetal Plastic	Acetal Plastic, Stainless Steel	Clear Polyurethane	Buna N	.49 lbs./22 kgs.

# Aluminum Filters With Clear Bowl



**Application:** The QN series is an excellent point-of-use filter when element visibility is required. Coalescing, particulate and adsorption elements available. Includes plastic manual twist drain.

How to Order:

<input type="checkbox"/> <b>QN</b>	<input type="checkbox"/>	<input type="checkbox"/> <b>N</b>	—	<input type="checkbox"/>	<input type="checkbox"/>	<input type="checkbox"/>
<u>Port Size</u>	<u>Media Grade</u>	<u>Media Type</u>		<u>Accessories</u>		
1 = 1/4" NPT 15 = 3/8" NPT 2 = 1/2" NPT	blank for 3PU, AU 4 6 8 10	G T F H C CU QU 3PU AU		N = None D = Differential Pressure Indicator G = Differential Pressure Gauge		

Note: Although the element size is not included in the part number construction for this filter, the size, 10-025, is needed to order replacement elements. For Example, 6C10-025 X 8.

For Example: QN15N-10QUN for complete assembly, including element. QN15NN X 1 for an empty housing.

# Low Flow, Dual-Stage In Line Filters

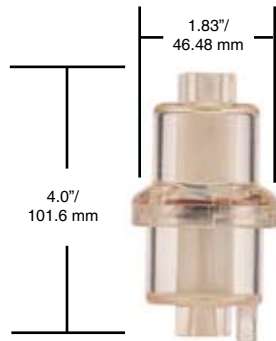

**Application:** The ILN, IKN in-lines are used for low flow circuit protection on sensing instruments, analyzers, air-logic, and other control devices. High-efficiency coalescing and particulate elements are available. Drain types available include manual push, constant bleed or no drain.

**The design:** This twist-lock plastic housing is designed for 50 PSIG Maximum operating pressure. The two-stage filter design allows for high efficiency element replacement and the reuse of the 74 micron prefilter (74P05-011 X 10).

How to Order:

<input type="checkbox"/> <b>I</b>	<input type="checkbox"/>	<input type="checkbox"/> <b>N</b>	—	<input type="checkbox"/>	<input type="checkbox"/>	<input type="checkbox"/>	<b>05-011</b>
<u>Port Size</u>	<u>Type of Drain</u>	<u>Media Grade</u>		<u>Media Type</u>		<u>Element Size</u>	
L = 1/8" NPT K = 1/8" NPT with brass inserts	blank for no drain; closed D = Open; constant bleed drain V = Valved; manual drain	4 6 8 10		G T F H			

For Example: IKND-4G05-011 for complete assembly, including element. IKND X 1 for an empty housing.

## Specifications:

Model Number	Port Size (NPT)	Max. Pressure	Max. Temp. (Element Type)	Materials of Construction			Seals	Shipping Weight
				Head	Internals	Bowl		
QN1N, QN15N, QN2N	1/4", 3/8", 1/2"	125 PSIG/ 9 bar	125°F (All Media types)	Aluminum	Stainless Steel, Acetal Plastic	Clear Polyurethane	Buna N	.86 lbs./ .39 kgs.
ILN/IKN	1/8"	50 PSIG/ 3 bar	125°F (All media types)	ILN: Nylon IKN: Clear polyurethane	Neoprene	ILN: Nylon IKN: Clear polyurethane	Silicone Rubber	.1 lbs./ .05 kgs.
ILND/IKND	1/8"	50 PSIG/ 3 bar	125°F (All media types)	ILND: Nylon IKND: Clear polyurethane	Neoprene	ILND: Nylon IKND: Clear polyurethane	Silicone Rubber	.1 lbs./ .05 kgs.
ILNV/IKNV	1/8"	50 PSIG/ 3 bar	125°F (All media types)	ILNV: Nylon IKNV: Clear polyurethane	Neoprene	ILNV: Nylon IKNV: Clear polyurethane	Silicone Rubber	.1 lbs./ .05 kgs.

# High Efficiency Disposable In-Line Filters

**Application:** These high-efficiency, disposable in-line filters are great for analyzer and sensor protection, gas sampling, micro-system operation and robot and animation air preparation. This clear, nylon housing allows visible inspection of collected particulate. The full length internal tube support gives higher strength, even with system upsets.



## Type ID In-line filters

The Type ID enclosure in conjunction with a 'G', 'T', 'F' or '44P' series element is designed to provide the most reliable, long lived, instrument air source, sensor protection, sample cleansing and purification available today. The center core provides stable backup support, reduces internal (tare) volume, centers the tube in the housing and distributes the contaminant load along the tube's entire length. Elements in the housing are sealed by a positive serrated arrangement with built-in redundancy, ultrasonically welded.

## Type MD In-line filters

The Type MD housing in conjunction with a 'G', 'T', 'F' or '5P' element is designed to provide a high reliability instrument air source or sensor protection where some levels of condensed moisture or oil are present. A stand-pipe is molded into the lower housing to allow for a dry exit chamber as liquids collect at the tube base. Up to 3cc of liquid can be stored in this manner. The same tube size is employed as in the Type ID. Typical applications involve high condensate conditions such as vacuum or higher temperature systems.

## Type SD In-line filters

For critical point-of-use, vapor free instrument or medical systems the Type SD provides Maximum activated surface exposure to the process gas while pre-filtering with grade 10 pads and preventing media migration with exit safety filters.

### Adsorbing Media Available

- Type A:** Activated carbon for general use oil vapor removal.
- Type J:** Silica gel moisture trap dries gas, turns white when expended.
- Type M:** 13X molecular sieve for selective polishing and 'last trace' light hydrocarbon vapor removal.
- Type O:** Activated dye turns red when exposed to oil in system.

### Specifications:

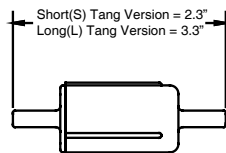

Standard 1/4" O.D. Tangs

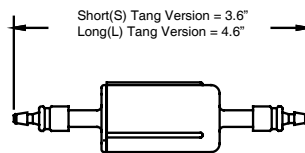

4S = 1/8" Straight Barbs

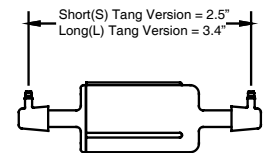

4A = 1/8" Right Angle Barbs

### Specifications:

Model Number	Max. Pressure	Max. Temp.
ID/SD/MD	100 PSIG/7 bar	125°F (All media types)

### How to Order:

- |                          |                            |                           |                          |  |                          |
|--------------------------|----------------------------|---------------------------|--------------------------|--|--------------------------|
| <input type="checkbox"/> | <input type="checkbox"/> — | <input type="checkbox"/>  | <input type="checkbox"/> | <input type="checkbox"/>                     | <input type="checkbox"/> |
| Type ID                  | Tang Length                | Media Grade               | Media Type               | End Connections                              |                          |
| MD                       | N = Long                   | Leave blank for SD,5P,44P | Available for ID only    | blank = Standard Tangs (1/4" outer diameter) |                          |
| SD                       | S = Short                  | 4                         | Available for MD only    | 4S = 1/8" Straight Barbs                     |                          |
|                          |                            | 6                         | 5P = 5 micron SS mesh    | 4A = 1/8" Right Angle Barbs                  |                          |
|                          |                            | 8                         | Available for ID/MD      |  |                          |
|                          |                            | 10                        | G = Epoxy                |  |                          |
|                          |                            |                           | T = PTFE                 |  |                          |
|                          |                            |                           | F = Fluorocarbon         |  |                          |
|                          |                            |                           | Available for SD only    |  |                          |
|                          |                            |                           | A = Activated Carbon     |  |                          |
|                          |                            |                           | J = Silica Gel           |  |                          |
|                          |                            |                           | M = Molecular Sieve      |  |                          |
|                          |                            |                           | O = Oil Activated Dye    |  |                          |

For Example: IDN-6G  
for complete assembly,  
including element.

# Flow Data (SCFM) and Replacement Elements

Note: Flow rates shown are for largest port size in each housing series.

Filter Housing Model	Media Grade	20 PSIG	40 PSIG	60 PSIG	80 PSIG	100 PSIG	150 PSIG	250 PSIG	500 PSIG	1500 PSIG	5000 PSIG	Replacement Elements Available *Insert grade. Quantity of elements per Box follows the 'X'
S1R	4	1.9	3.1	4.2	5.3	6.4	9	15	29	85	280	*C04-023 X 10
	6	2.5	4.0	5.5	6.9	8.4	12	19	38	111	367	*F04-023 X 10
	10	3.0	4.8	6.5	8.3	10	14	23	45	132	437	*H04-023 X 10 *T04-023 X 10 *G04-023 X 10
A1R	4	1.9	3.1	4.2	5.3	6.4	9	15	29	-	-	*C04-023 X 10
	6	2.5	4.0	5.5	6.9	8.4	12	19	38	-	-	*F04-023 X 10
	10	3.0	4.8	6.5	8.3	10	14	23	45	-	-	*H04-023 X 10 *T04-023 X 10 *G04-023 X 10
S1IL	4	1.1	1.7	2.3	3.0	3.6	5	8	16	48	157	*G04-013 X 10
	6	1.4	2.2	3.1	3.9	4.7	7	11	21	62	205	*T04-013 X 10
	10	1.7	2.7	3.7	4.7	5.7	8	13	26	75	249	*F04-013 X 10
S2PS	4	4.8	7.6	10.4	13.2	16	-	-	-	-	-	*H10-025 X 8
	6	6.7	10.5	14.3	18.2	22	-	-	-	-	-	*F10-025 X 10
	10	11.2	17.6	24.1	30.5	37	-	-	-	-	-	*G10-025 X 10 *T10-025 X 10
S2PL	4	13.6	21.5	29.3	37.2	45	-	-	-	-	-	*H10-070 X 4
	6	18.2	28.6	39.1	49.5	60	-	-	-	-	-	*F10-070 X 10
	10	31.5	49.6	67.7	85.9	104	-	-	-	-	-	*G10-070 X 10 *T10-070 X 10
S2SS	4	4.8	7.6	10.4	13.2	16	23	37	-	-	-	*H10-025 X 8
	6	6.7	10.5	14.3	18.2	22	32	51	-	-	-	*F10-025 X 10
	10	11.2	17.6	24.1	30.5	37	53	85	-	-	-	*G10-025 X 10 *T10-025 X 10
S2SL	4	13.6	21.5	29.3	37.2	45	65	104	-	-	-	*H10-070 X 4
	6	18.2	28.6	39.1	49.5	60	86	138	-	-	-	*F10-070 X 10
	10	31.5	49.6	67.7	85.9	104	149	240	-	-	-	*G10-070 X 10 *T10-070 X 10
S3C	4	19.7	31.0	42.3	53.7	65	93	-	-	-	-	*CU13 -087 X 2
	6	27.2	42.9	58.6	74.3	90	129	-	-	-	-	3PU13 -087 X 2
	10	45.4	71.5	97.7	123.8	150	215	-	-	-	-	AU13 -087 X 2
S4C	4	24.2	38.2	52.1	66.1	80	115	-	-	-	-	*CU13 -087 X 2
	6	33.3	52.5	71.6	90.8	110	158	-	-	-	-	3PU13 -087 X 2
	10	51.4	81.1	110.7	140.4	170	244	-	-	-	-	AU13 -087 X 2
SN8S	4	102.9	162.1	221.4	280.7	340	488	785	1526	-	-	*CU24-187 X 1
	6	136.1	214.6	293.1	371.5	450	646	1038	2019	-	-	AU24-187 X 1
	10	226.9	357.7	488.4	619.2	750	1077	1731	3366	-	-	7CVP24-187 X 1 100WS24-187 X 1 3PU24-187 X 1
Q1S	4	1.7	2.7	3.6	4.6	5.6	8	-	-	-	-	*HM06-013 X 10
	6	2.3	3.7	5.0	6.4	7.7	11	-	-	-	-	AM06-013 X 10
	10	3.9	6.2	8.5	10.7	13	19	-	-	-	-	
H1S	4	1.7	2.7	3.6	4.6	5.6	8	13	-	-	-	*HM06-013 X 10
	6	2.3	3.7	5.0	6.4	7.7	11	18	-	-	-	AM06-013 X 10
	10	3.9	6.2	8.5	10.7	13	19	30	-	-	-	



# Flow Data (SCFM) and Replacement Elements

Note: Flow rates shown are for largest port size in each housing series.

Filter Housing Model	Media Grade	20 PSIG	40 PSIG	60 PSIG	80 PSIG	100 PSIG	150 PSIG	250 PSIG	500 PSIG	1500 PSIG	5000 PSIG	Replacement Elements Available *Insert grade. Quantity of elements per Box follows the 'X'
KN1S	4	2.4	3.8	5.2	6.6	8	11	-	-	-	-	*C06-016 X 10
	6	3.0	4.8	6.5	8.3	10	14	-	-	-	-	*F06-016 X 10
	10	5.1	8.1	11.1	14.0	17	24	-	-	-	-	*H06-016 X 10 *T06-016 X 10 *G06-016 X 10 75P06-016 X 10
P1N, QN1N	4	3.3	5.2	7.2	9.1	11	-	-	-	-	-	*C10-025 X 8
	6	4.5	7.2	9.8	12.4	15	-	-	-	-	-	*QU10-025 X 8
	10	6.1	9.5	13.0	16.5	20	-	-	-	-	-	*CU10-025 X 8 *G10-025 X 10 *H10-025 X 8 *T10-025 X 8 *F10-025 X 10 3PU10-025 X 8 AU10-025 X 8
QN15N, QN2N	4	6.4	10.0	13.7	17.3	21	-	-	-	-	-	*C10-025 X 8
	6	8.5	13.4	18.2	23.1	28	-	-	-	-	-	*QU10-025 X 8
	10	16.3	25.8	35.2	44.6	54	-	-	-	-	-	*CU10-025 X 8 *G10-025 X 10 *H10-025 X 8 *T10-025 X 8 *F10-025 X 10 3PU10-025 X 8 AU10-025 X 8
ILNV, IKNV ILND, IKND ILN, IKN	4	1.3	2.0	-	-	-	-	-	-	-	-	*H05-011 X 10
	6	1.7	2.7	-	-	-	-	-	-	-	-	*T05-011 X 10
	10	2.8	4.5	-	-	-	-	-	-	-	-	*G05-011 X 10 74P05-011 X 10 *F05-011 X 10
ID, MD	4	0.8	1.3	1.8	2.2	2.7	-	-	-	-	-	Note: These filters are disposable and sold in Box quantities of 10. No replacement elements available.
	6	1.1	1.7	2.3	2.9	3.5	-	-	-	-	-	
	10	1.6	2.5	3.5	4.4	5.3	-	-	-	-	-	