



Air Preparation Products
Global Air Preparation Series

Introduction	B2-B7
Particulate Filters	B8-B13
Coalescing Filters	B14-B19
Regulators	B20-B31
Proportional Regulators	B32-B41
Filter / Regulators	B42-B49
Lubricators	B50-B55
Combinations	B56-B59
Dump Valves / Soft Start Valves	B60-B65
Redundant Safety Exhaust Valve	B66-B69
Accessories	B70-B80



For inventory, lead time, and kit lookup, visit www.pdnplu.com

B2
Global Air Preparation
Introduction
Filters
Coalescers
Regulators
Filter / Regulators
Lubricators
Combinations
Accessories and Kits



DECLARATION OF COMPLIANCE (ROHS)

European Directive 2011/65/EU – RoHS (Restriction us of certain Hazardous Substances in electrical and electronic equipment), restricts the use of the 6 substances in the manufacture of specified electrical equipment.

- Lead:** Product containing lead and its compound (except for applications of lead as an alloying element by weight in steel up to 0.35%, in aluminium up to 0.4% and in copper alloys up to 4% and in circuit board solder) must not exceed 0.1% by weight
- Mercury:** The concentration level must not exceed 0.1% by volume
- Cadmium:** The concentration level must not exceed 0.01% by volume
- Hexavalent Chromioui:**
This is a corrosive protective finish used on our product line. Where this finish is utilized the Chromate solution is Hexavalent (Chrome 6) free.
- Polybrominated Biphenyls (PBB):**
The concentration level must not exceed 0.1% by weight. This substance is not know to be in any of our products.
- Polybrominated Diphenyl Esters (PBDE):**
The concentration level must not exceed 0.1% by weight. This substance is not know to be in any of our products.



Global Air Preparation products supplied by Parker Hannifin have been designed and manufactured in accordance with “sound engineering practice”, as defined by Article 3 of Pressure Equipment Directive 97/23/EC.



Global Air Preparation product range is in compliance with REACH to ensure continued compliance additions to the list of SVHC (Substance of Very High Concern) are reviewed periodically.

Global Air Preparation product range has been third party Shock & Vibration tested independently in accordance to EN 61373 : 1999, Category 2



Following Ignition Hazard Assessments performed on the non-electrical Global Air Preparation products they are in accordance with the requirements of EN 13463-1:2009, it was considered that the equipment does not contain its own source of ignition, and therefore is not within the scope of directive 94/9/EC.

The products can be used in a Group II Category 2 environment assuming that the ATEX Directive and the following conditions are complied with:

- Installation and maintenance of the product must be undertaken by qualified personnel.
- Do not mount the products in an area where impact may occur.
- Filters must be used to limit the introduction of particles and to capture particles generated in service.
- Supply air quality must be within ISO 8573-1:2010 Class 1.4.2.
- Maximum working temperature to be as stated on product label.
- WARNING – pulsating pressure and/or a closed circuit can generate heat.
- Deposits of dust on the product must not exceed 5mm thickness.
Refer to technical file for surface areas of plastics. The unit must be earthed via the compressed air supply line.
- The unit must not come into contact with liquid solvents, acids or alkalis
Refer to technical file for chemicals known to be incompatible. Product cleaning must be undertaken using a method complying with the specifications of the ATEX zone, preferably by using mild soap and water or antistatic products.
- Regulators, Filter Regulators:
Do not use Regulators or Filter Regulators within systems that can create vibration within the Regulator / Filter Regulator unit.
- Solenoid Operated Valves:
Are suitable for use in an ATEX environment, (Group II Category 2) providing ATEX approved solenoids are fitted.
- Technical file available on request.



Global Air Preparation product range has been designed and tested in accordance with ISO flow testing, envelope integrity, and catalog data presented.

- Filters – ISO 5782-1 & ISO 5782-2: 1997
- Regulators- ISO 6953-1 & ISO 6953-2: 2000
- Lubricators- ISO 6301-1 & ISO 6301-2: 2009



For inventory, lead times, and kit lookup, visit www.pdnplu.com

Parker Global Air Preparation System

**Global.
Modular.**



*Performance you need,
wherever you need it.*



Full featured particulate and coalescing filters, regulators, filter/regulators, and lubricators are available with a wide range of standard options to meet air preparation needs.

The comprehensive Global Air Preparation System is available in three body sizes with either BSPP, BSPT, or NPT to accommodate thread type requirements.

Individual units can easily be assembled into various combinations, utilizing patented modular lightweight body connectors.

www.parker.com/globalfrl

B

Global Air Preparation

Introduction

Filters

Coalescers

Regulators

Filter/
Regulators

Lubricators

Combinations

Accessories
and Kits



For inventory, lead time, and kit lookup, visit www.pdnplu.com

B3

Parker Hannifin Corporation
Pneumatic Division
Richland, Michigan
www.parker.com/pneumatics

A completely modular air preparation system

B
Global Air Preparation
Introduction
Filters
Coalescers
Regulators
Filter / Regulators
Lubricators
Combinations
Accessories and Kits

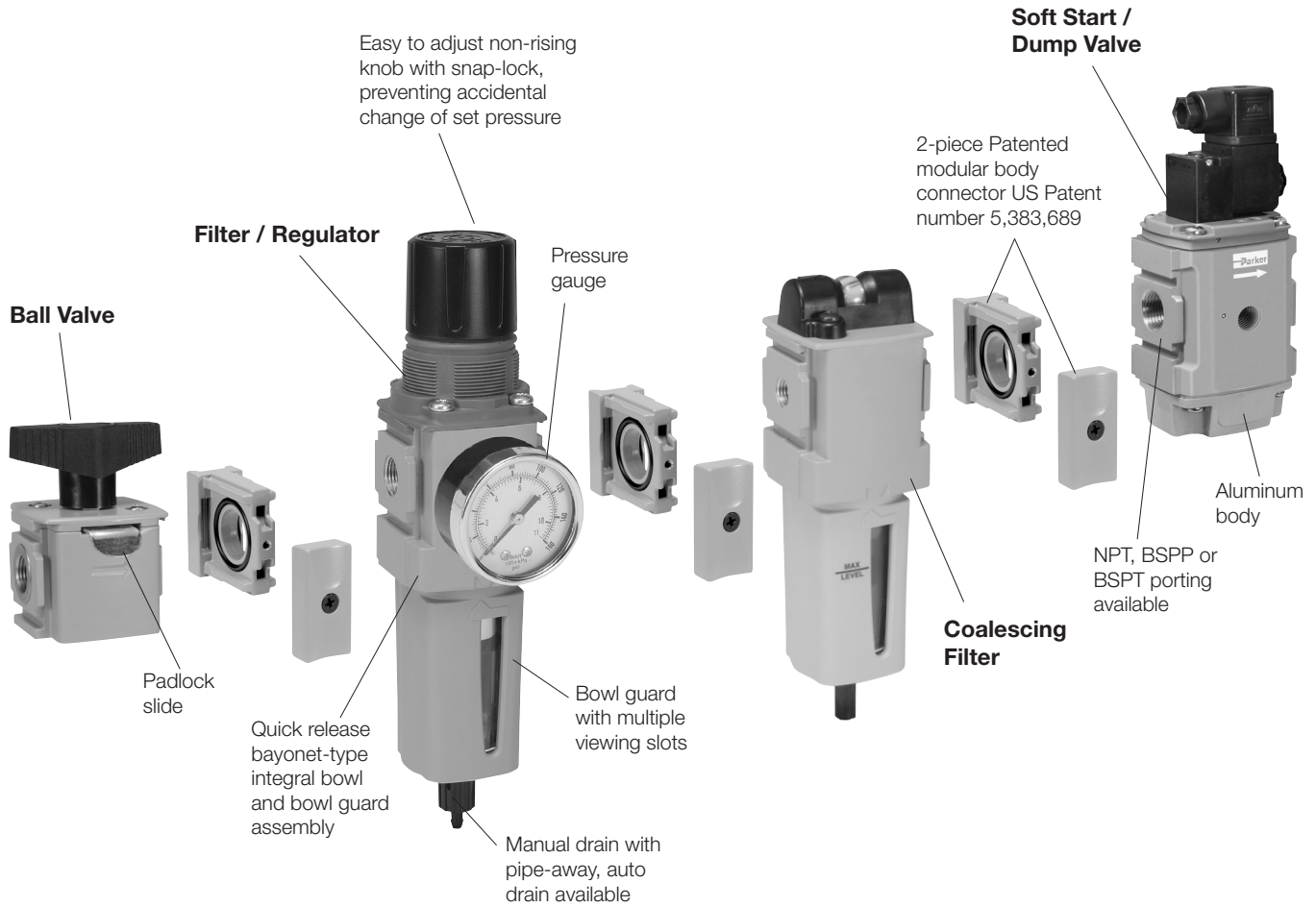

For inventory, lead times, and kit lookup, visit www.pdnplu.com

B4

Parker Hannifin Corporation
Pneumatic Division
Richland, Michigan
www.parker.com/pneumatics

Comprehensive Offering



P31 Mini Series
1/4" ports
40mm body width



P32 Compact Series
1/4", 3/8" and 1/2"
60mm body width



P33 Standard Series
1/2" and 3/4"
73mm body width



Filters

- 5 μ particulate, 1.0 μ and 0.01 μ coalescing, and adsorber available as standard
- Transparent or metal bowl with manual or auto float drains standard



Regulators

- Available as stand alone, common port and electronic proportional
- Both relieving and non-relieving versions available



Filter / Regulators

- Compact design for space savings
- Available with all the same standard options as the filters and regulators



Lubricators

- Proportional oil delivery over a wide range of air flows
- Fill under pressure



Combinations

- Compact design for space savings
- Easily assembled
- Many configurations available



Accessories

- Solenoid operated soft start, quick dump, and soft start/quick dump valves
- Manifold blocks
- Ball style lockout / shutoff valve
- Repair kits, gauges, etc.

B

Global Air Preparation

Introduction

Filters

Coalescers

Regulators

Filter / Regulators

Lubricators

Combinations

Accessories and Kits



For inventory, lead time, and kit lookup, visit www.pdnplu.com

B5

Parker Hannifin Corporation
Pneumatic Division
Richland, Michigan
www.parker.com/pneumatics

Air Preparation

P31 Mini Series

40mm body width

1/4" Ported

Flows up to:	scfm	(dm ³ /s, ANR)
Filter	25	(12)
Coalescer	7.5	(3.6)
Regulator	68	(32)
Filter/Regulator	22	(10)
Lubricator	52	(25)

Features:

- Space saving integral gauge
- Manifold style regulators available
- OSHA compliant shut-off valves
- Soft-Start & Quick Dump valves
- Electronic Proportional Regulator

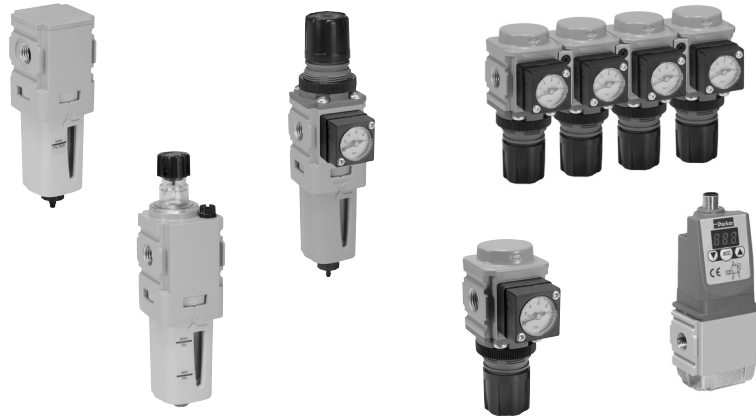

P32 Compact Series

60mm body width

1/4", 3/8", & 1/2" Ported

Flows up to:	scfm	(dm ³ /s, ANR)
Filter	82	(39)
Coalescer	36	(17)
Regulator	165	(78)
Filter/Regulator	136	(64)
Lubricator	90	(42)

Features:

- Manifold style regulators available
- OSHA Compliant shut-off valves
- Soft-Start & Quick Dump valves
- Electronic Proportional Regulator



P33 Standard Series

73mm body width

1/2" & 3/4" Ported

Flows up to:	scfm	(dm ³ /s, ANR)
Filter	85	(40)
Coalescer	72	(34)
Regulator	233	(111)
Filter/Regulator	230	(108)
Lubricator	150	(71)

Features:

- OSHA Compliant shut-off valves
- Soft-Start & Quick Dump valves (Utilizes P32 size only)
- Electronic proportional regulator (Utilizes P32 size only)



B
Global Air
Preparation

Introduction

Filters

Coalescers

Regulators

Filter/
Regulators

Lubricators

Combinations

Accessories
and Kits



For inventory, lead times, and kit lookup, visit www.pdnplu.com

Complete Pneumatic System

Common Port Manifold Regulators

- Multiple output pressures (P2, P3, P4, etc.) with common inlet (P1)
- Available in two sizes P31 and P32
- Balanced valve design for accurate pressure regulation
- Outlet pressure ports in front and rear of unit.
- Multiple spring ranges available

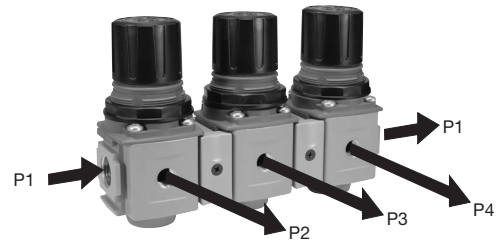

Electronic Proportional Regulator

- Electro-Pneumatic regulator
- Integrated systems control
- Accurate output pressure
- Micro parameter settings
- Selectable I/O parameters
- Quick, full flow exhaust
- LED display indicates output pressure
- No air consumption in steady state
- Multiple mounting options
- Protection to IP65



P31P Mini Series



P32P Compact Series

Semi Precision Regulator and Filter/Regulator

- Available in P32 compact series
- Fine adjustment sensitivity
- Good repeatability and minimal pressure drop
- Good flow capacity
- Light gray knob for easy identification



Optional Tamperproof Kits

- One facilitates the permanent tamperproofing of the Regulator and Filter/Regulator units
- Hinged black part clamps over control knob and is locked in place after sliding yellow cover over it
- Other allows for removable lockout/tagout tamperproofing
 - Four pad lock location holes tagout
 - Hinged locking clamp secures over existing knob via yellow cover which is slid over into place



Additional Options P32 Only (Consult factory for availability)

- T-Handle
- Preset
- Preset and Tamperproof
- Pressure Limiter



B

Global Air Preparation

Introduction

Filters

Coalescers

Regulators

Filter/Regulators

Lubricators

Combinations

Accessories and Kits



For inventory, lead time, and kit lookup, visit www.pdnplu.com

B7

Parker Hannifin Corporation
Pneumatic Division
Richland, Michigan
www.parker.com/pneumatics

P31 Particulate Filter – Mini

- Integral 1/4" ports (NPT, BSPP & BSPT)
- High efficiency 5 micron element as standard
- Excellent water removal efficiency
- Robust but lightweight aluminum construction
- One hand operation for easy element cartridge removal
- Positive bayonet latch to ensure correct & safe fitting

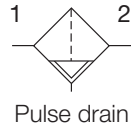
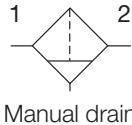

Operating information

Supply pressure (max):	
Plastic bowl	150 psig (10 bar)
Metal bowl	250 psig (17 bar)
Operating temperature:	
Plastic bowl	14°F to 125°F (-10°C to 52°C)
Metal bowl	14°F to 150°F (-10°C to 65.5°C)
Standard filtration:	5 micron
Flow capacity*:	25 scfm (12 dm ³ /s, ANR)
Useful retention†:	0.4 US oz. (12 cm ³)
Weight:	0.24 lb (0.11 kg)
* Inlet pressure 91.3 psig (6.3 bar). Pressure drop 4.9 psig (0.34 bar).	
† Useful retention refers to volume below the quiet zone baffle.	

Port size	Description †	Part number
1/4"	Poly bowl, manual drain	P31FB92EGMN
1/4"	Poly bowl, pulse drain	P31FB92EGBN
1/4"	Metal bowl, manual drain	P31FB92EMMN
1/4"	Metal bowl, pulse drain	P31FB92EMBN

† For polycarbonate bowl, see caution in Engineering Section A.

Air quality:
 Within ISO 8573-1: 1991 Class 3 (Particulates)
 Within ISO 8573-1: 2001 Class 6 (Particulates)

Ordering information:

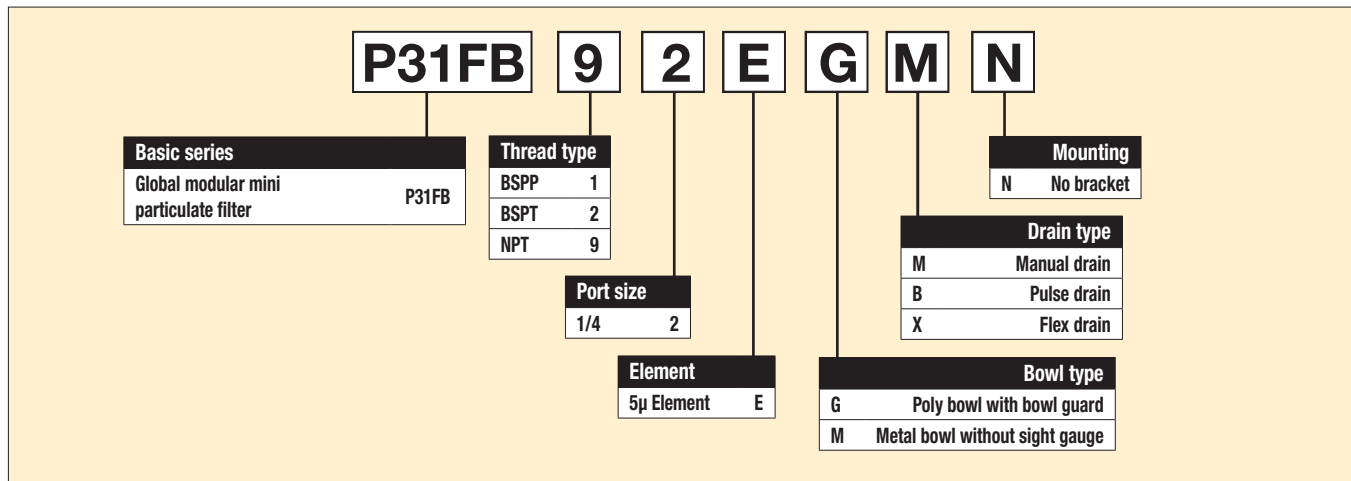

Most popular.



For inventory, lead times, and kit lookup, visit www.pdnplu.com

Mini Particulate Filters

Material Specifications

Body	Aluminum
Body cap	ABS
Plastic bowl	Polycarbonate
Metal bowl	Aluminum
Bowl guard	Nylon
Element retainer	Acetal
Baffle	Acetal
Filter element	Sintered polyethylene
Seals	Nitrile

Repair and Service Kits

Plastic bowl / bowl guard, manual drain	P31KB00BGM
Metal bowl / w/o sight gauge, manual drain	P31KB00BMM
Plastic bowl / bowl guard, pulse drain	P31KB00BGB
Metal bowl / w/o sight gauge, pulse drain	P31KB00BMB
5µ particle filter element	P31KA00ESE
C-bracket (fits to body)	P31KA00MW
T-bracket with body connector	P31KA00MT
Body connector	P31KA00CB

Air Preparation Products Global Air Preparation

Flow Charts

P31FB 1/4" Filter

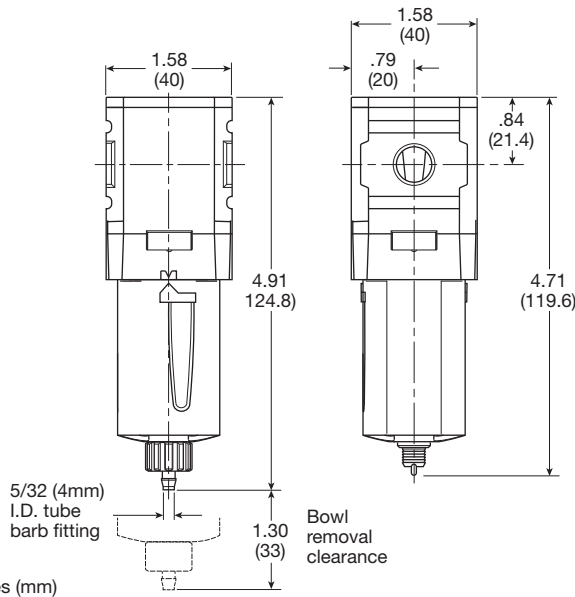
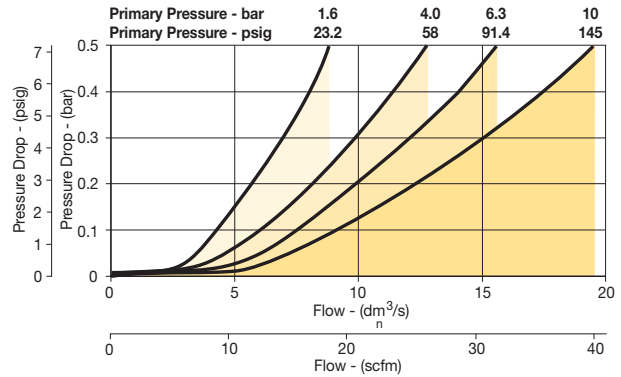

Manual Drain

Pulse Drain



For inventory, lead time, and kit lookup, visit www.pdnplu.com

P32 Particulate Filter – Compact

- Integral 1/4", 3/8" or 1/2" ports (NPT, BSPP & BSPT)
- High efficiency 5 micron element as standard
- Excellent water removal efficiency
- Robust but lightweight aluminum construction
- Positive bayonet latch to ensure correct & safe fitting

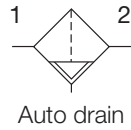
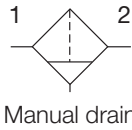

Port size	Description †	Part number
1/4"	Poly bowl, manual drain	P32FB92EGMN
1/4"	Poly bowl, auto drain	P32FB92EGAN
1/4"	Metal bowl, manual drain	P32FB92ESMN
1/4"	Metal bowl, auto drain	P32FB92ESAN
3/8"	Poly bowl, manual drain	P32FB93EGMN
3/8"	Poly bowl, auto drain	P32FB93EGAN
3/8"	Metal bowl, manual drain	P32FB93ESMN
3/8"	Metal bowl, auto drain	P32FB93ESAN
1/2"	Poly bowl, manual drain	P32FB94EGMN
1/2"	Poly bowl, auto drain	P32FB94EGAN
1/2"	Metal bowl, manual drain	P32FB94ESMN
1/2"	Metal bowl, auto drain	P32FB94ESAN

† For polycarbonate bowl, see caution in Engineering Section A.

Operating information

Supply pressure (max):	
Plastic bowl	150 psig (10 bar)
Metal bowl	250 psig (17 bar)
Operating temperature:	
Plastic bowl	-13°F to 125°F (-25°C to 52°C)
Metal bowl	-13°F to 150°F (-25°C to 65.5°C)
Standard filtration:	5 micron
Flow capacity*:	
1/4"	50 scfm (24 dm³/s, ANR)
3/8"	78 scfm (37 dm³/s, ANR)
1/2"	82 scfm (39 dm³/s, ANR)
Useful retention†:	1.7 US oz. (51 cm³)
Weight:	0.62 lb (0.28 kg)
* Inlet pressure 91.3 psig (6.3 bar). Pressure drop 4.9 psig (0.34 bar).	
† Useful retention refers to volume below the quiet zone baffle.	

Air quality:
 Within ISO 8573-1: 1991 Class 3 (Particulates)
 Within ISO 8573-1: 2001 Class 6 (Particulates)

Ordering Information:

P32FB 9 2 E G M N

Basic series Global modular compact particulate filter P32FB	Thread type BSPP 1 BSPT 2 NPT 9	Port size 1/4 2 3/8 3 1/2 4	Element 5µ Element E	Mounting N No bracket
				Drain type M Manual drain A Auto drain X Flex drain
				Bowl type G Poly bowl with bowl guard M Metal bowl without sight gauge S Metal bowl with sight gauge

Most popular.



For inventory, lead times, and kit lookup, visit www.pdnplu.com

Compact Particulate Filters

Material Specifications

Body	Aluminum
Body cap	ABS
Plastic bowl	Polycarbonate
Metal bowl	Aluminum
Bowl guard	Nylon
Deflector	Polypropylene
Element retainer / Baffle	Acetal
Filter element	Sintered polyethylene
Seals	Nitrile
Sight gauge	Nylon

Repair and Service Kits

Plastic bowl / bowl guard, manual drain	P32KB00BGM
Metal bowl / sight gauge, manual drain	P32KB00BSM
Auto drain	P32KA00DA
5µ particle filter element	P32KA00ESE
L-bracket (fits to body)	P32KA00ML
T-bracket (fits to body connector)	P32KA00MB
T-bracket with body connector	P32KA00MT
Body connector	P32KA00CB

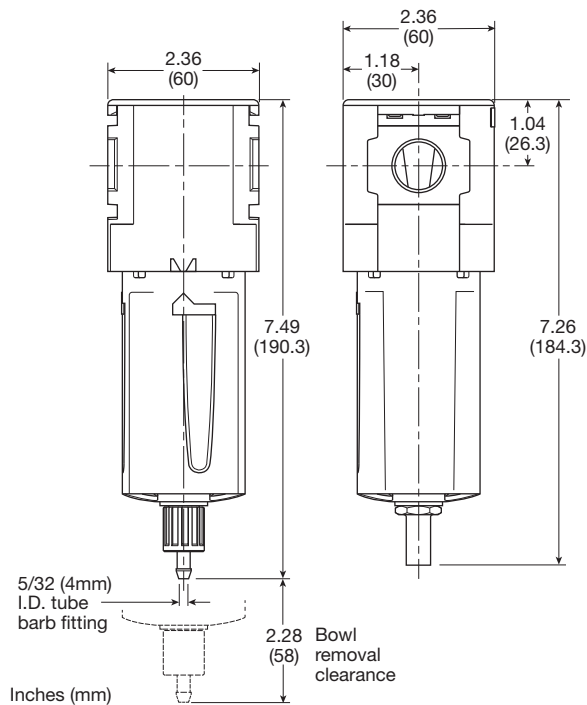

Manual Drain

Automatic Drain

Air Preparation Products Global Air Preparation

Flow Charts

P32FB 1/4" Filter

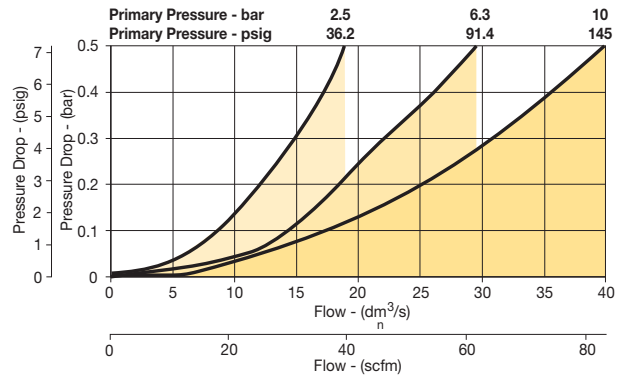

P32FB 3/8" Filter

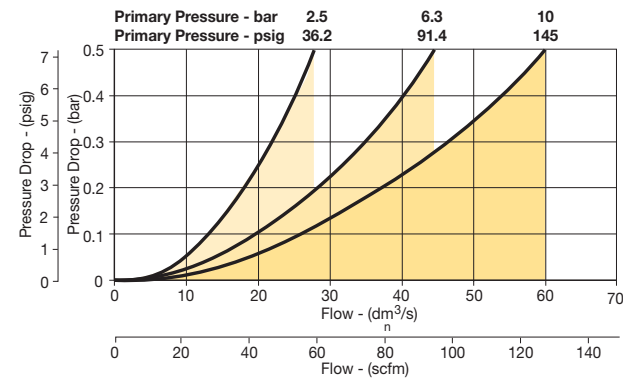

P32FB 1/2" Filter

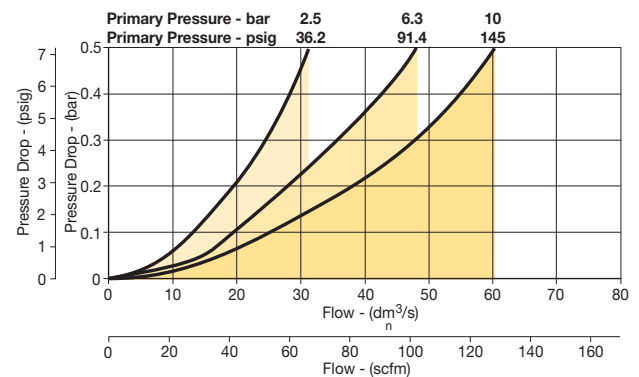

B

Global Air Preparation

Introduction

Filters

Coalescers

Regulators

Filter/Regulators

Lubricators

Combinations

Accessories and Kits



For inventory, lead time, and kit lookup, visit www.pdnplu.com

P33 Particulate Filter – Standard

- Integral 1/2" or 3/4" ports (NPT, BSPP & BSPT)
- High efficiency 5 micron element as standard
- Excellent water removal efficiency
- Robust but lightweight aluminum construction
- Positive bayonet latch to ensure correct & safe fitting

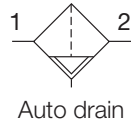
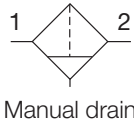

Port size	Description †	Part number
1/2"	Poly bowl, manual drain	P33FA94EGMN
1/2"	Poly bowl, auto drain	P33FA94EGAN
1/2"	Metal bowl, manual drain	P33FA94ESMN
1/2"	Metal bowl, auto drain	P33FA94ESAN
3/4"	Poly bowl, manual drain	P33FA96EGMN
3/4"	Poly bowl, auto drain	P33FA96EGAN
3/4"	Metal bowl, manual drain	P33FA96ESMN
3/4"	Metal bowl, auto drain	P33FA96ESAN

† For polycarbonate bowl, see caution in Engineering Section A.

Operating information

Supply pressure (max):	
Plastic bowl	150 psig (10 bar)
Metal bowl	250 psig (17 bar)
Operating temperature:	
Plastic bowl	-13°F to 125°F (-25°C to 52°C)
Metal bowl	-13°F to 150°F (-25°C to 65.5°C)
Standard filtration:	5 micron
Flow capacity*:	1/2 85 scfm (40 dm ³ /s, ANR)
	3/4 102 scfm (48 dm ³ /s, ANR)
Useful retention†:	2.8 US oz. (85 cm ³)
Weight:	1.01 lb (0.46 kg)
* Inlet pressure 91.3 psig (6.3 bar). Pressure drop 4.9 psig (0.34 bar).	
† Useful retention refers to volume below the quiet zone baffle.	

Air quality:
 Within ISO 8573-1: 1991 Class 3 (Particulates)
 Within ISO 8573-1: 2001 Class 6 (Particulates)

Ordering Information:

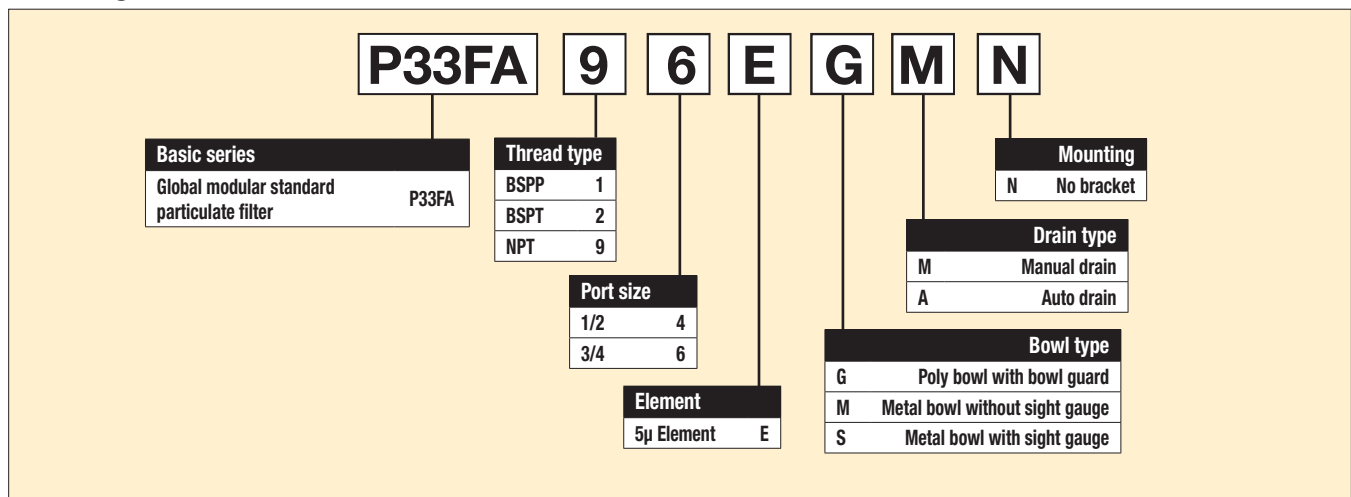

Most popular.



For inventory, lead times, and kit lookup, visit www.pdnplu.com

Standard Particulate Filters

Material Specifications

Body	Aluminum
Bowl cap	ABS
Plastic bowl	Polycarbonate
Metal bowl	Aluminum
Bowl guard	Nylon
Deflector	Polypropylene
Element retainer / Baffle	Acetal
Filter element	Sintered polyethylene
Seals	Nitrile
Sight gauge	Nylon

Repair and Service Kits

Plastic bowl / bowl guard, manual drain	P33KA00BGM
Metal bowl / sight gauge, manual drain	P33KA00BSM
Auto drain	P32KA00DA
5µ particle filter element	P33KA00ESE
L-bracket (fits to body)	P33KA00ML
T-bracket (fits to body connector)	P32KA00MB
T-bracket with body connector	P33KA00MT
Body connector	P32KA00CB

Air Preparation Products Global Air Preparation

Flow Charts

P33FA 1/2" Filter

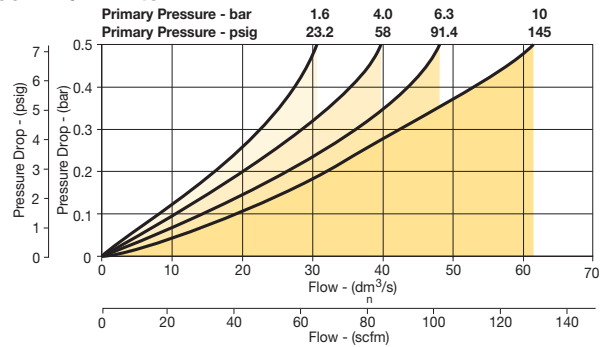

P33FA 3/4" Filter

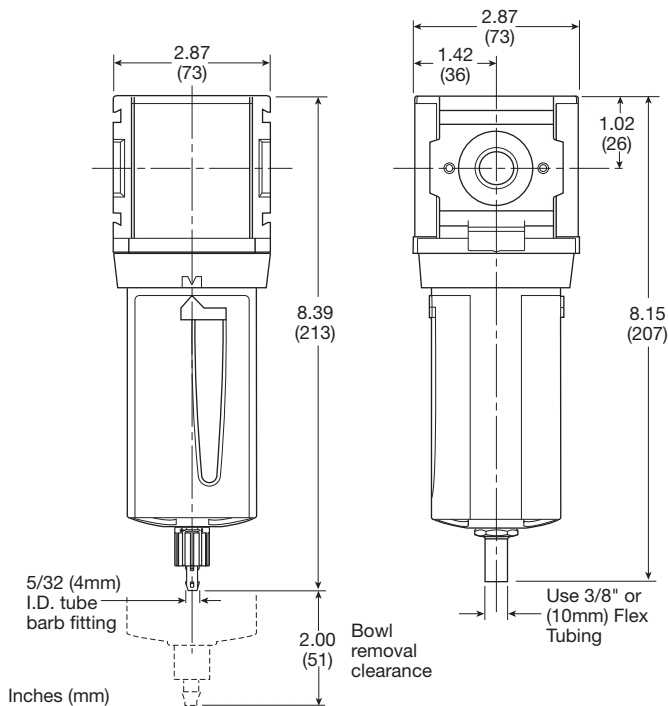
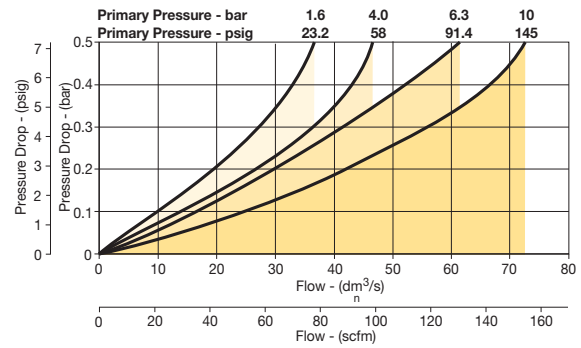

Manual Drain

Automatic Drain

B
Global Air Preparation
Introduction
Filters
Coalescers
Regulators
Filter/Regulators
Lubricators
Combinations
Accessories and Kits



For inventory, lead time, and kit lookup, visit www.pdnplu.com

P31 Coalescing and Adsorber Filters – Mini

- Integral 1/4" ports (NPT, BSPP & BSPT)
- Removes liquid aerosols and sub micron particles
- Oil free air for critical applications, such as air gauging, pneumatic instrumentation and control
- Differential Pressure Indicator (DPI) standard on coalescing filters
- Positive bayonet latch to ensure correct and safe fitting
- Adsorbing activated carbon element removes oil vapors and most hydrocarbons



Note: To optimize the life of coalescing element, it is advisable to install a P31F pre-filter with a 5 micron element upstream of the coalescing filter.

To optimize the life of an Adsorber it is advisable to install a P31 Coalescing Filter upstream of the Adsorber. Adsorber element should be replaced approximately every 1000 hours of service.

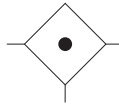

Port size	Description †	Element	Part number
1/4"	Poly bowl, manual drain	0.01 micron	P31FB92DGMN
1/4"	Poly bowl, pulse drain	0.01 micron	P31FB92DGBN
1/4"	Metal bowl, manual drain	0.01 micron	P31FB92DMMN
1/4"	Metal bowl, pulse drain	0.01 micron	P31FB92DMBN

† For polycarbonate bowl, see caution in Engineering Section A.

Operating information

Supply pressure (max):	
Poly bowl	150 psig (10 bar)
Metal bowl w/ DPI	150 psig (10 bar)
Metal bowl w/o DPI	250 psig (17 bar)
Operating temperature:	
Plastic bowl	14°F to 125°F (-10°C to 52°C)
Metal bowl	14°F to 150°F (-10°C to 65.5°C)
Standard filtration:	1.0 and 0.01 micron
Adsorber	Max. oil carryover (ppm w/w) 0.003 @ 70°F (21°C)
Flow capacity*:	
1.0 micron coalescing	12 scfm (5.5 dm ³ /s, ANR)
0.01 micron coalescing	7.5 scfm (3.6 dm ³ /s, ANR)
Activated carbon adsorber	12.7 scfm (6 dm ³ /s, ANR)
Useful retention†:	0.4 US oz. (12 cm ³)
Weight:	0.24 lb (0.11 kg)

* Inlet pressure 91.3 psig (6.3 bar). Pressure drop 3 psig (0.2 bar), saturated element.

† Useful retention refers to volume below the quiet zone baffle.

Ordering Information:

Basic series	Thread type	Port size	Element	Mounting	Drain type	Bowl type
Global modular mini coalescing filter P31FB	BSPP 1 BSPT 2 NPT 9	1/4 2	0.01µ Element C 0.01µ Element with DPI D 1µ Element 9 1µ Element with DPI Q Adsorber A	N No bracket	B Pulse drain M Manual drain X Flex drain	G Poly bowl with bowl guard M Metal bowl without sight gauge

Most popular.



For inventory, lead times, and kit lookup, visit www.pdnplu.com

Mini Coalescing and Adsorber Filters

Material Specifications

Body	Aluminum
Body cap	ABS
Plastic bowl	Polycarbonate
Metal bowl	Aluminum
Filter element	Borosilicate cloth
Adsorber element	Activated carbon
Seals	Nitrile

Repair and Service Kits

Plastic bowl / bowl guard, manual drain	P31KB00BGM
Metal bowl / w/o sight gauge ,manual drain	P31KB00BMM
Plastic bowl / bowl guard, pulse drain	P31KB00BGB
Metal bowl / w/o sight gauge, pulse drain	P31KB00BMB
1µ coalescing filter element	P31KA00ES9
0.01µ coalescing filter element	P31KA00ESC
Activated carbon adsorber filter element	P31KA00ESA
C-bracket (fits to body)	P31KA00MW
T-bracket with body connector	P31KA00MT
Body connector	P31KA00CB
Differential pressure indicator (replacement)	P31KB00RQ

Air Preparation Products Global Air Preparation

Flow Charts

P31FB - 1.0 micron flow

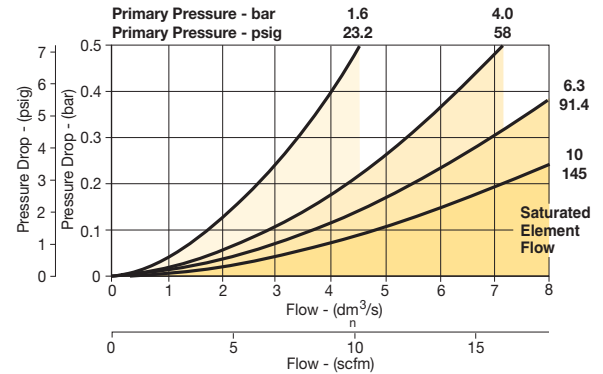

P31FB - 0.01 micron flow

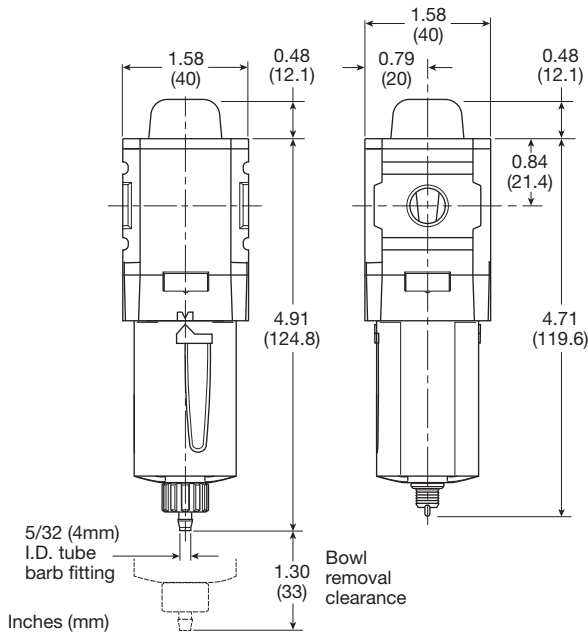
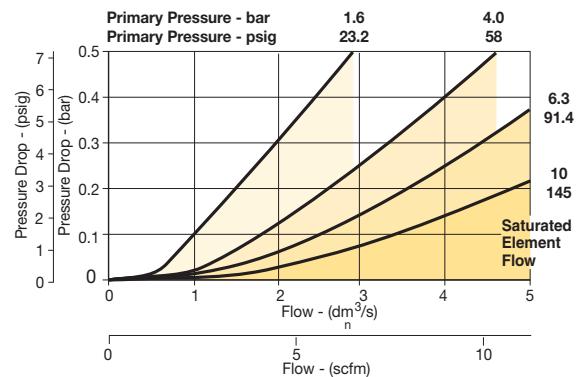

Manual Drain

Pulse Drain

B

Global Air Preparation

Introduction

Filters

Coalescers

Regulators

Filter/Regulators

Lubricators

Combinations

Accessories and Kits



For inventory, lead time, and kit lookup, visit www.pdnplu.com

P32 Coalescing and Adsorber Filters – Compact

- Integral 1/4", 3/8" or 1/2" ports (NPT, BSPP & BSPT)
- Removes liquid aerosols and sub micron particles
- Oil free air for critical applications, such as air gauging, pneumatic instrumentation and control
- Differential Pressure Indicator (DPI) standard on Coalescing Filters
- Positive bayonet latch to ensure correct & safe fitting
- Adsorbing activated carbon element removes oil vapors and most hydrocarbons

Note: To optimize the life of coalescing element, it is advisable to install a P32F pre-filter with a 5 micron element upstream of the coalescing filter. To optimize the life of an Adsorber it is advisable to install a P32 Coalescing Filter upstream of the Adsorber. Adsorber element should be replaced approximately every 1000 hours of service.

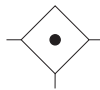

Port size	Description †	Element	Part number
1/4"	Poly bowl, manual drain	0.01 micron	P32FB92DGMN
1/4"	Poly bowl, auto drain	0.01 micron	P32FB92DGAN
1/4"	Metal bowl, manual drain	0.01 micron	P32FB92DSMN
1/4"	Metal bowl, auto drain	0.01 micron	P32FB92DSAN
3/8"	Poly bowl, manual drain	0.01 micron	P32FB93DGMN
3/8"	Poly bowl, auto drain	0.01 micron	P32FB93DGAN
3/8"	Metal bowl, manual drain	0.01 micron	P32FB93DSMN
3/8"	Metal bowl, auto drain	0.01 micron	P32FB93DSAN
1/2"	Poly bowl, manual drain	0.01 micron	P32FB94DGMN
1/2"	Poly bowl, auto drain	0.01 micron	P32FB94DGAN
1/2"	Metal bowl, manual drain	0.01 micron	P32FB94DSMN
1/2"	Metal bowl, auto drain	0.01 micron	P32FB94DSAN

† For polycarbonate bowl, see caution in Engineering Section A.

Operating information

Supply pressure (max):	
Poly bowl	150 psig (10 bar)
Metal bowl w/ DPI	150 psig (10 bar)
Metal bowl w/o DPI	250 psig (17 bar)
Operating temperature:	
Plastic bowl	-13°F to 125°F (-25°C to 52°C)
Metal bowl	-13°F to 150°F (-25°C to 65.5°C)
Standard filtration:	1.0 and 0.01 micron
Adsorber	Max. oil carryover (ppm w/w) 0.003 @ 70°F (21°C)
Flow capacity*:	
1.0 micron coalescing	53 scfm (25 dm³/s, ANR)
0.01 micron coalescing	36 scfm (17 dm³/s, ANR)
Activated carbon adsorber	85 scfm (40 dm³/s, ANR)
Useful retention†:	1.7 US oz. (51 cm³)
Weight:	0.71 lb (0.32 kg)

* Inlet pressure 91.3 psig (6.3 bar). Pressure drop 3 psig (0.2 bar), saturated element.

† Useful retention refers to volume below the quiet zone baffle.

Ordering Information:

P32FB	9	2	D	G	M	N
Basic series Global modular compact coalescing filter P32FB	Thread type BSPP 1 BSPT 2 NPT 9	Port size 1/4 2 3/8 3 1/2 4	Element 0.01µ Element C 0.01µ Element with DPI D 1µ Element 9 1µ Element with DPI Q Adsorber A	Drain type M Manual drain A Auto drain X Flex drain	Bowl type G Poly bowl with bowl guard M Metal bowl without sight gauge S Metal bowl with sight gauge	Mounting N No bracket

Most popular.



For inventory, lead times, and kit lookup, visit www.pdnplu.com

Material Specifications

Body	Aluminum
Body cap	ABS
Plastic bowl	Polycarbonate
Metal bowl	Aluminum
Filter element	Borosilicate cloth
Adsorber	Activated carbon
Seals	Nitrile
Sight gauge	Nylon

Repair and Service Kits

Plastic bowl / bowl guard, manual drain	P32KB00BGM
Metal bowl / sight gauge, manual drain	P32KB00BSM
Auto drain	P32KA00DA
1µ coalescing filter element	P32KA00ES9
0.01µ coalescing filter element	P32KA00ESC
Activated carbon adsorber filter element	P32KA00ESA
L-bracket (fits to body)	P32KA00ML
T-bracket (fits to body connector)	P32KA00MB
T-bracket with body connector	P32KA00MT
Body connector	P32KA00CB
Differential pressure indicator (replacement)	P32KA00RQ

Flow Charts

P32FB - 1.0 micron flow

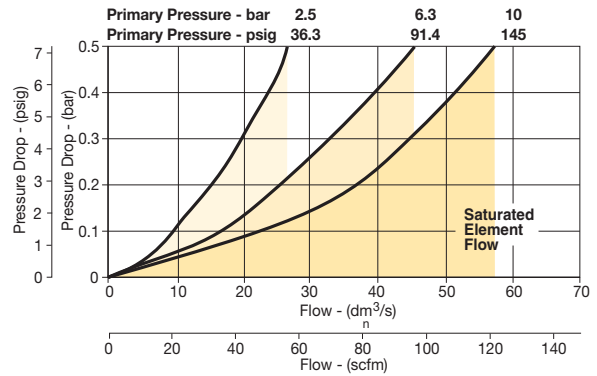

P32FB - 0.01 micron flow

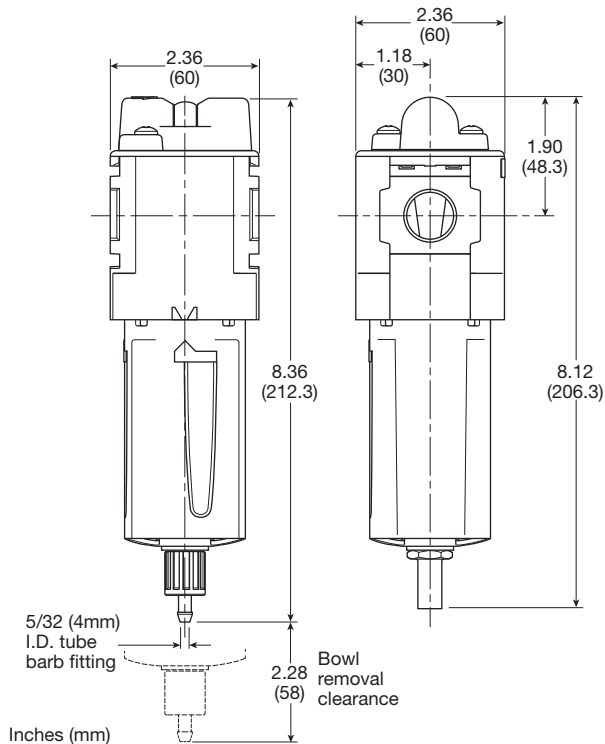
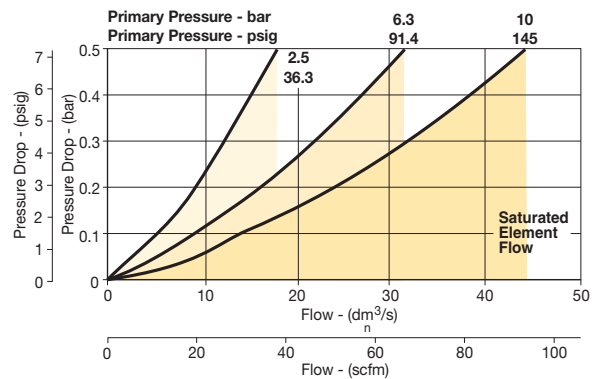

Manual Drain

Automatic Drain

B
Global Air Preparation
Introduction
Filters
Coalescers
Regulators
Filter/Regulators
Lubricators
Combinations
Accessories and Kits



For inventory, lead time, and kit lookup, visit www.pdnplu.com

P33 Coalescing and Adsorber Filters – Standard

- Integral 1/2" or 3/4" ports (NPT, BSPP & BSPT)
- Removes liquid aerosols and sub micron particles
- Oil free air for critical applications, such as air gauging, pneumatic instrumentation and control
- Differential Pressure Indicator (DPI) standard on Coalescing Filters
- Positive bayonet latch to ensure correct & safe fitting
- Adsorbing activated carbon element removes oil vapors and most hydrocarbons



Note: To optimize the life of coalescing element, it is advisable to install a P33F pre-filter with a 5 micron element upstream of the coalescing filter.

To optimize the life of an Adsorber it is advisable to install a P33 Coalescing Filter upstream of the Adsorber. Adsorber element should be replaced approximately every 1000 hours of service.

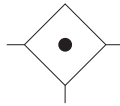

Port size	Description †	Element	Part number
1/2"	Poly bowl, manual drain	0.01 micron	P33FA94DGMN
1/2"	Poly bowl, auto drain	0.01 micron	P33FA94DGAN
1/2"	Metal bowl, manual drain	0.01 micron	P33FA94DSMN
1/2"	Metal bowl, auto drain	0.01 micron	P33FA94DSAN
3/4"	Poly bowl, manual drain	0.01 micron	P33FA96DGMN
3/4"	Poly bowl, auto drain	0.01 micron	P33FA96DGAN
3/4"	Metal bowl, manual drain	0.01 micron	P33FA96DSMN
3/4"	Metal bowl, auto drain	0.01 micron	P33FA96DSAN

† For polycarbonate bowl, see caution in Engineering Section A.

Operating information

Supply pressure (max):	
Poly bowl	150 psig (10 bar)
Metal bowl w/ DPI	150 psig (10 bar)
Metal bowl w/o DPI	250 psig (17 bar)
Operating temperature:	
Plastic bowl	-13°F to 125°F (-25°C to 52°C)
Metal bowl	-13°F to 150°F (-25°C to 65.6°C)
Standard filtration:	1.0 and 0.01 micron
Adsorber	Max. oil carryover (ppm w/w) 0.003 @ 70°F (21°C)
Flow capacity*:	
1.0 micron coalescing	68 scfm (32 dm³/s, ANR)
0.01 micron coalescing	42 scfm (20 dm³/s, ANR)
Activated carbon adsorber	72 scfm (34 dm³/s, ANR)
Useful retention†:	2.8 US oz. (85 cm³)
Weight:	1.10 lb (0.50 kg)

* Inlet pressure 91.3 psig (6.3 bar). Pressure drop 3 psig (0.2 bar), saturated element.

† Useful retention refers to volume below the quiet zone baffle.

Ordering information:

P33FA
9
6
D
G
M
N

Basic series Global modular standard coalescing filter P33FA	Thread type BSPP 1 BSPT 2 NPT 9	Port size 1/2 4 3/4 6	Element 0.01µ Element C 0.01µ Element with DPI D 1µ Element 9 1µ Element with DPI Q Adsorber A	Mounting N No bracket	Drain type M Manual drain A Auto drain	Bowl type G Poly bowl with bowl guard M Metal bowl without sight gauge S Metal bowl with sight gauge
--	---	------------------------------------	--	---------------------------------	---	--

Most popular.



For inventory, lead times, and kit lookup, visit www.pdnplu.com

Material Specifications

Body	Aluminum
Body cap	ABS
Plastic bowl	Polycarbonate
Metal bowl	Aluminum
Filter element	Borosilicate cloth
Adsorber	Activated carbon
Seals	Nitrile
Sight gauge	Nylon

Repair and Service Kits

Plastic bowl / bowl guard, manual drain	P33KA00BGM
Metal bowl / sight gauge, manual drain	P33KA00BSM
Auto drain	P32KA00DA
1µ coalescing filter element	P33KA00ES9
0.01µ coalescing filter element	P33KA00ESC
Activated carbon adsorber filter element	P33KA00ESA
L-bracket (fits to body)	P33KA00ML
T-bracket (fits to body connector)	P32KA00MB
T-bracket with body connector	P32KA00MT
Body connector	P32KA00CB
Differential pressure indicator (replacement)	P32KA00RQ

Flow Charts

P33FA - 1.0 micron flow

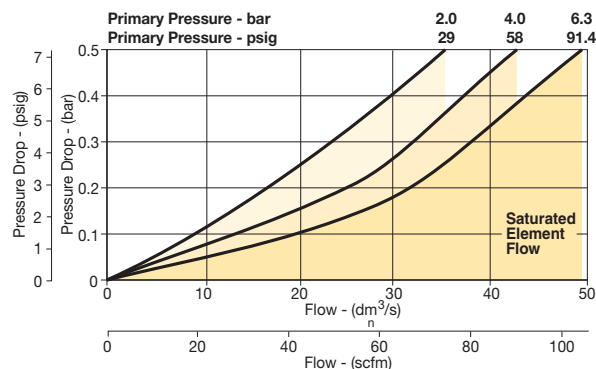

P33FA - 0.01 micron flow

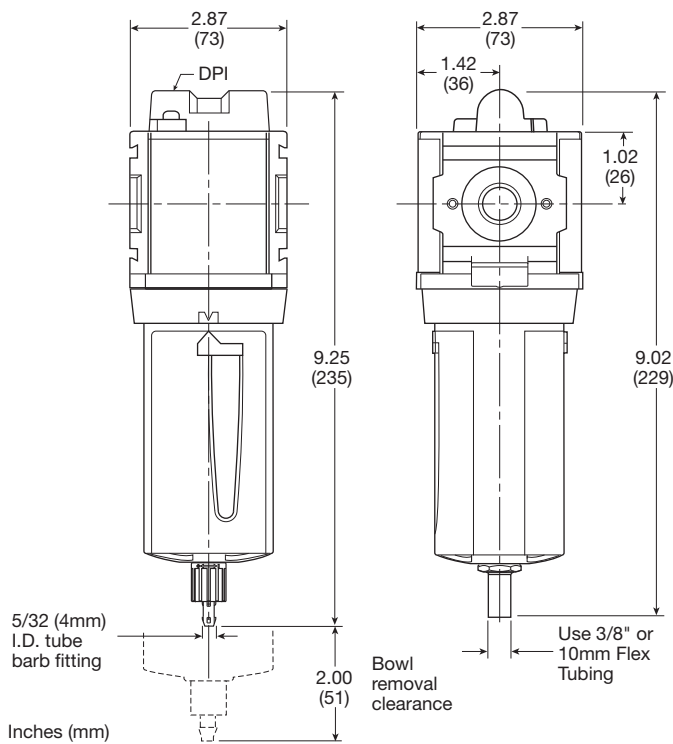
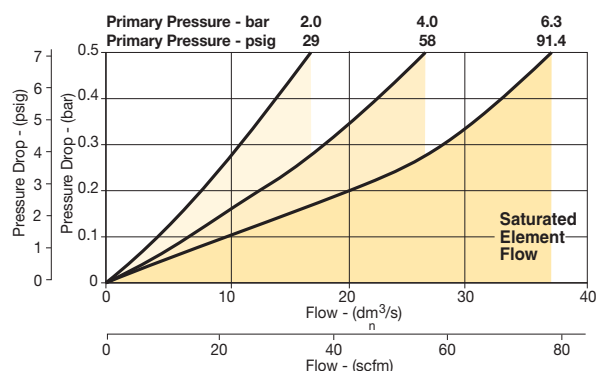

Manual Drain

Automatic Drain

B
Global Air Preparation
Introduction
Filters
Coalescers
Regulators
Filter/Regulators
Lubricators
Combinations
Accessories and Kits



For inventory, lead time, and kit lookup, visit www.pdnplu.com

P31 Regulators – Mini

- Integral 1/4" ports (NPT, BSPP & BSPT)
- Robust but lightweight aluminum construction
- Secondary pressure ranges
- Secondary aspiration plus balanced poppet provides quick response and accurate pressure regulation.
- Relieving & non-relieving types
- Non-rising knob

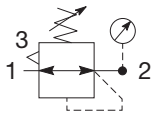

Self relieving regulator with gauge

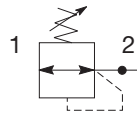

Non-relieving regulator

Operating information

Flow capacity*:	1/4	68 scfm (32 dm ³ /s, ANR)
Operating temperature†:		-4°F to 150°F (-20°C to 65.5°C)
Supply pressure (max):		300 psig (20 bar)
Adjusting range pressure:		30 psig (0-2 bar) 60 psig (0-4 bar) 125 psig (0-8 bar) 232 psig (0-16 bar)
Gauge port (2 each)**:		1/8 BSPP, BSPT, NPT
Weight:		0.37 lb (0.17 kg)

* Inlet pressure 145 psig (10 bar). Secondary pressure 91.3 psig (6.3 bar) and 14.5 psig (1 bar) pressure drop.

** Non-gauge option only.

† Units with square gauges: 5°F to 150°F (-15°C to 65.5°C)

Port size	Description (relieving)	Gauge	Part number
1/4"	125 psig (8 bar)	None	P31RB92BNNP
1/4"	125 psig (8 bar)	Square	P31RB92BN5P

Ordering Information:

P31RB	9	2	B	N	5	P
Basic series Global modular mini regulator P31RB	Thread type BSPP 1 BSPT 2 NPT 9	Port size 1/4 2	Relief Relieving B Non-relieving N Reverse flow-relieving R	Mounting P Plastic panel mount nut	Adjustment range	
				With square gauge		With round gauge
				psig	bar	Z 30 psig; 2 bar; 0.2 MPa
				1 = 30*	V = 2*	M 60 psig; 4 bar; 0.4 MPa
				3 = 60	S = 4	G 125 psig; 8 bar; 0.8 MPa
				5 = 125	T = 8	J 232 psig; 16 bar; 1.6 MPa
				* Regulator comes with gauge respective to the adjustment range selected.		Without gauge
				Adjustment		Y 30 psig; 2 bar; 0.2 MPa
				N Non-rising knob		L 60 psig; 4 bar; 0.4 MPa
						N 125 psig; 8 bar; 0.8 MPa
						H 232 psig; 16 bar; 1.6 MPa

Most popular.



For inventory, lead times, and kit lookup, visit www.pdnplu.com

B20

Parker Hannifin Corporation
 Pneumatic Division
 Richland, Michigan
www.parker.com/pneumatics

Material Specifications

Body	Aluminum
Adjustment knob	Acetal
Bonnet	PBT
Diaphragm assembly	Brass / Nitrile
Valve assembly	Brass / Nitrile
Springs	Steel
Seals	Nitrile
Panel nut	Acetal

Repair and Service Kits

Diaphragm repair kit - relieving	P31KB00RB
Diaphragm repair kit - non-relieving	P31KB00RC
Panel mount nut - aluminum	P31KA00MM
Panel mount nut - plastic	P31KA00MP
Angle bracket (attaches via panel nut)	P31KB00MR
C-bracket (fits to body)	P31KA00MW
T-bracket with body connector	P31KA00MT
Body connector	P31KA00CB

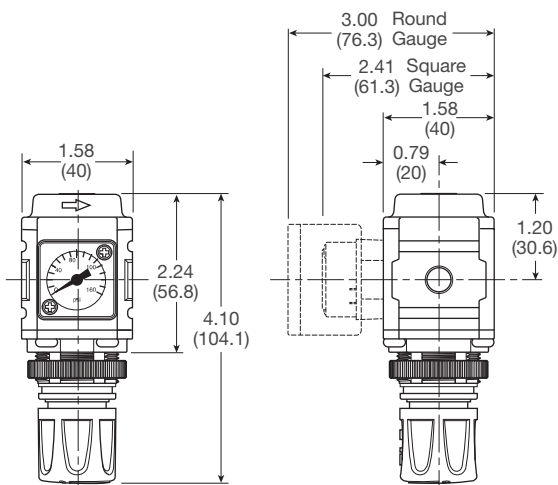

Inches (mm)

NOTE: 1.20 in. (30mm) hole required for panel nut mounting.

Flow Charts

P31RB 1/4" Regulator

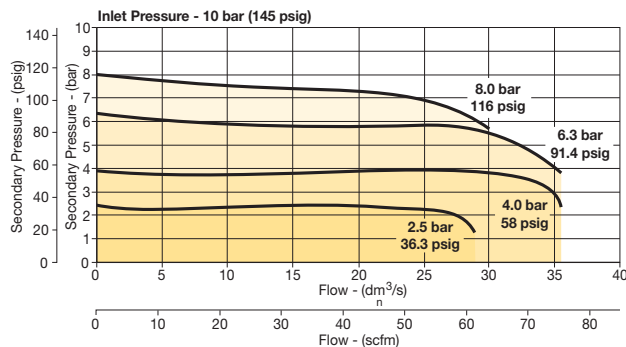

WARNING
 Product rupture can cause serious injury.
 Do not connect regulator to bottled gas.
 Do not exceed Maximum primary pressure rating.

CAUTION:

REGULATOR PRESSURE ADJUSTMENT – The working range of knob adjustment is designed to permit outlet pressures within their full range. Pressure adjustment beyond this range is also possible because the knob is not a limiting device. This is a common characteristic of most industrial regulators, and limiting devices may be obtained only by special design. For best performance, regulated pressure should always be set by increasing the pressure up to the desired setting.

Gauges

Square flush mount gauge	0-4 bar	K4511SCR04B
	0-11 bar	K4511SCR11B
	0-60 psig	K4511SCR060
	0-160 psig	K4511SCR160
Square with adapter kit	0-4 bar	P6G-PR10040
	0-11 bar	P6G-PR10110
	0-60 psig	P6G-PR90060
1.00" Round 1/8" center back mount	0-60 psig / 0-4 bar	K4510N18060
	0-160 psig / 0-11 bar	K4510N18160
	0-30 psig / 0-2 bar	K4515N18030
40mm Round 1/8" center back mount (Not for use with common port regulators)	0-60 psig / 0-4 bar	K4515N18060
	0-160 psig / 0-11 bar	K4515N18160

For best performance, regulated pressure should always be set by increasing the pressure up to the desired setting.

B
Global Air Preparation
Introduction
Filters
Coalescers
Regulators
Filter/Regulators
Lubricators
Combinations
Accessories and Kits



For inventory, lead time, and kit lookup, visit www.pdnplu.com

P31 Common P1 Regulators – Mini

- Manifold style regulator with line pressure on both sides
- Pressure output is at front or rear
- Inlet port 1/4" (NPT, BSPP & BSPT)
- Working port 1/8"
- Robust construction
- Secondary pressure ranges
- Secondary aspiration plus balanced poppet provides quick response and accurate pressure regulation
- Relieving & non-relieving types
- Non-rising knob

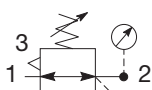
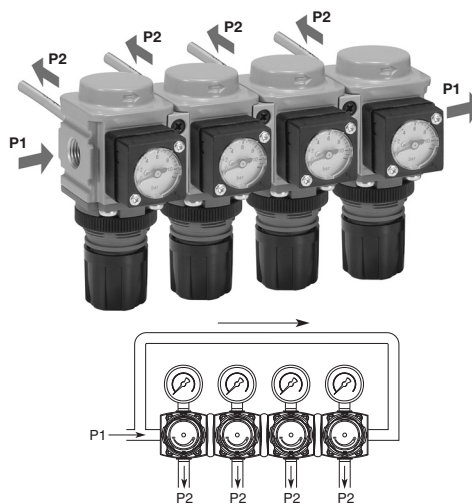

Self relieving regulator with gauge

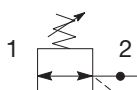

Non-relieving regulator

Port size	Description (relieving)	Gauge	Part number
1/4"	125 psig (8 bar)	None	P31HB92BNNP
1/4"	125 psig (8 bar)	Square	P31HB92BN5P

Operating information

Flow capacity*:	42 scfm (20 dm ³ /s, ANR)
Operating temperature:	-4°F to 150°F (-20°C to 65.5°C)
Supply pressure (max):	300 psig (20 bar)
Adjusting range pressure:	30 psig (0-2 bar) 60 psig (0-4 bar) 125 psig (0-8 bar) 232 psig (0-16 bar)
P1 port size (inlet/outlet)	1/4 NPT, BSPP, BSPT
P2 regulated ports (2 ea.)	1/8 NPT, BSPP, BSPT
Weight:	0.66 lb (0.30 kg)

* Inlet pressure 145 psig (10 bar). Secondary pressure 91.3 psig (6.3 bar) and 14.5 psig (1 bar) pressure drop.

Ordering Information:

P31HB **9** **2** **B** **N** **5** **P**

Basic series

Global modular mini common regulator **P31HB**

Thread type

BSPP	1
BSPT	2
NPT	9

Port size †

1/4	2
-----	---

† Working port 1/8".

Mounting

P Plastic panel mount nut

Relief

Relieving	B
Non-relieving	N
Reverse flow-relieving	R

Adjustment range

With square gauge		With round gauge	
psig	bar	Z	M
1 = 30*	V = 2*	G	J
3 = 60	S = 4		
5 = 125	T = 8		

* Regulator comes with gauge respective to the adjustment range selected.

Adjustment

N Non-rising knob

Without gauge

Y	30 psig; 2 bar; 0.2 MPa
L	60 psig; 4 bar; 0.4 MPa
N	125 psig; 8 bar; 0.8 MPa
H	232 psig; 16 bar; 1.6 MPa

Most popular.



For inventory, lead times, and kit lookup, visit www.pdnplu.com

Mini Common P1 Regulators

Materials of Construction

Body	Aluminum
Adjustment knob	Acetal
Bonnet	Glass-filled PBT
Diaphragm assembly	Brass / Nitrile
Valve assembly	Brass / Nitrile

Repair and Service Kits

Diaphragm repair kit - relieving	P31KB00RB
Diaphragm repair kit - non-relieving	P31KB00RC
Panel mount nut - aluminum	P31KA00MM
Panel mount nut - plastic	P31KA00MP
Angle bracket (attaches via panel nut)	P31KB00MR
T-bracket with body connector	P31KA00MT
Body connector	P31KA00CB

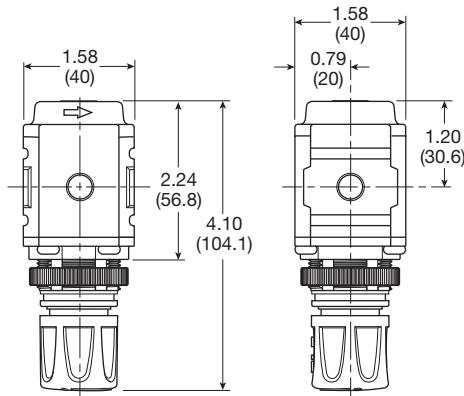

Inches (mm)

NOTE: 1.20 in. (30mm) hole required for panel nut mounting.

Air Preparation Products Global Air Preparation

Flow Charts

P31HB 1/4" Common Regulator

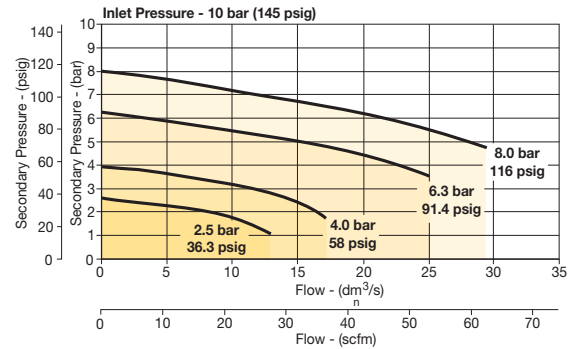

⚠ WARNING

**Product rupture can cause serious injury.
Do not connect regulator to bottled gas.
Do not exceed Maximum primary pressure rating.**

CAUTION:

REGULATOR PRESSURE ADJUSTMENT – The working range of knob adjustment is designed to permit outlet pressures within their full range. Pressure adjustment beyond this range is also possible because the knob is not a limiting device. This is a common characteristic of most industrial regulators, and limiting devices may be obtained only by special design. For best performance, regulated pressure should always be set by increasing the pressure up to the desired setting.

Gauges

Square with adapter kit	0-4 bar	P6G-PR10040
	0-11 bar	P6G-PR10110
	0-60 psig	P6G-PR90060
	0-160 psig	P6G-PR90160
1.00" round 1/8" center back mount	0-60 psig / 0-4 bar	K4510N18060
	0-160 psig / 0-11 bar	K4510N18160

For best performance, regulated pressure should always be set by increasing the pressure up to the desired setting.

B

Global Air Preparation

Introduction

Filters

Coalescers

Regulators

Filter/Regulators

Lubricators

Combinations

Accessories and Kits



For inventory, lead time, and kit lookup, visit www.pdnplu.com

P32 Regulators – Compact

- Integral 1/4", 3/8" or 1/2" ports (NPT, BSPP & BSPT)
- Robust but lightweight aluminum construction
- Secondary pressure ranges
- Secondary aspiration plus balanced poppet provides quick response and accurate pressure regulation
- Relieving & non-relieving types
- Non-rising knob
- Available T-handle

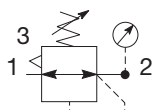

Self relieving regulator with gauge

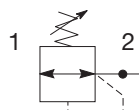

Non-relieving regulator

Port size	Description (relieving)	Gauge	Part number
1/4"	125 psig (8 bar)	None	P32RB92BNNP
1/4"	125 psig (8 bar)	Round	P32RB92BNGP
3/8"	125 psig (8 bar)	None	P32RB93BNNP
3/8"	125 psig (8 bar)	Round	P32RB93BNGP
1/2"	125 psig (8 bar)	None	P32RB94BNNP
1/2"	125 psig (8 bar)	Round	P32RB94BNGP

Operating information

Flow capacity*:	
1/4	148 scfm (70 dm ³ /s, ANR)
3/8, 1/2	165 scfm (78 dm ³ /s, ANR)
Operating temperature:	-13°F to 150°F (-25°C to 65.5°C)
Supply pressure (max):	300 psig (20 bar)
Adjusting range pressure:	30 psig (0-2 bar) 60 psig (0-4 bar) 125 psig (0-8 bar) 250 psig (0-17 bar)
Gauge port (2 each)	1/4 NPT, BSPP, BSPT
Weight:	0.90 lb (0.41 kg)
* Inlet pressure 145 psig (10 bar). Secondary pressure 91.3 psig (6.3 bar) and 14.5 psig (1 bar) pressure drop.	

Ordering Information:

P32RB		9	2	B	N	G	P																												
Basic series Global modular compact regulator P32RB		Thread type BSPP 1 BSPT 2 NPT 9		Port size 1/4 2 3/8 3 1/2 4		Relief Relieving B Non-relieving N																													
						Mounting P Plastic panel mount nut																													
						Adjustment range																													
						<table border="1"> <thead> <tr> <th colspan="2">With square gauge</th> <th colspan="2">With round gauge</th> </tr> <tr> <th>psig</th> <th>bar</th> <th>Z</th> <th>M</th> </tr> </thead> <tbody> <tr> <td>1 = 30*</td> <td>V = 2*</td> <td>30 psig; 2 bar; 0.2 MPa</td> <td>60 psig; 4 bar; 0.4 MPa</td> </tr> <tr> <td>3 = 60</td> <td>S = 4</td> <td>G 125 psig; 8 bar; 0.8 MPa</td> <td>J 250 psig; 17 bar; 1.7 MPa</td> </tr> <tr> <td>5 = 125</td> <td>T = 8</td> <td colspan="2">Without gauge</td> </tr> <tr> <td colspan="2"></td> <td>Y 30 psig; 2 bar; 0.2 MPa</td> <td>L 60 psig; 4 bar; 0.4 MPa</td> </tr> <tr> <td colspan="2"></td> <td>N 125 psig; 8 bar; 0.8 MPa</td> <td>H 250 psig; 17 bar; 1.7 MPa</td> </tr> </tbody> </table>		With square gauge		With round gauge		psig	bar	Z	M	1 = 30*	V = 2*	30 psig; 2 bar; 0.2 MPa	60 psig; 4 bar; 0.4 MPa	3 = 60	S = 4	G 125 psig; 8 bar; 0.8 MPa	J 250 psig; 17 bar; 1.7 MPa	5 = 125	T = 8	Without gauge				Y 30 psig; 2 bar; 0.2 MPa	L 60 psig; 4 bar; 0.4 MPa			N 125 psig; 8 bar; 0.8 MPa	H 250 psig; 17 bar; 1.7 MPa
With square gauge		With round gauge																																	
psig	bar	Z	M																																
1 = 30*	V = 2*	30 psig; 2 bar; 0.2 MPa	60 psig; 4 bar; 0.4 MPa																																
3 = 60	S = 4	G 125 psig; 8 bar; 0.8 MPa	J 250 psig; 17 bar; 1.7 MPa																																
5 = 125	T = 8	Without gauge																																	
		Y 30 psig; 2 bar; 0.2 MPa	L 60 psig; 4 bar; 0.4 MPa																																
		N 125 psig; 8 bar; 0.8 MPa	H 250 psig; 17 bar; 1.7 MPa																																
						Adjustment N Non-rising knob T T-Handle																													
						* Regulator comes with gauge respective to the adjustment range selected.																													

Most popular.



For inventory, lead times, and kit lookup, visit www.pdnplu.com

Material Specifications

Body	Aluminum
Adjustment knob	Acetal
Bonnet	Glass-filled nylon
Diaphragm assembly	Nitrile / Zinc
Valve assembly	Brass / Nitrile
Springs	Steel, stainless steel
Seals	Nitrile
Panel nut	Acetal

Repair and Service Kits

Diaphragm repair kit - relieving	P32KB00RB
Diaphragm repair kit - non-relieving	P32KB00RC
Panel mount nut - aluminum	P32KA00MM
Panel mount nut - plastic	P32KA00MP
Angle bracket (attaches via panel nut)	P32KB00MR
T-bracket with body connector	P32KA00MT
T-bracket	P32KA00MB
Body connector	P32KA00CB

WARNING

**Product rupture can cause serious injury.
 Do not connect regulator to bottled gas.
 Do not exceed Maximum primary pressure rating.**

CAUTION:

REGULATOR PRESSURE ADJUSTMENT – The working range of knob adjustment is designed to permit outlet pressures within their full range. Pressure adjustment beyond this range is also possible because the knob is not a limiting device. This is a common characteristic of most industrial regulators, and limiting devices may be obtained only by special design. For best performance, regulated pressure should always be set by increasing the pressure up to the desired setting.

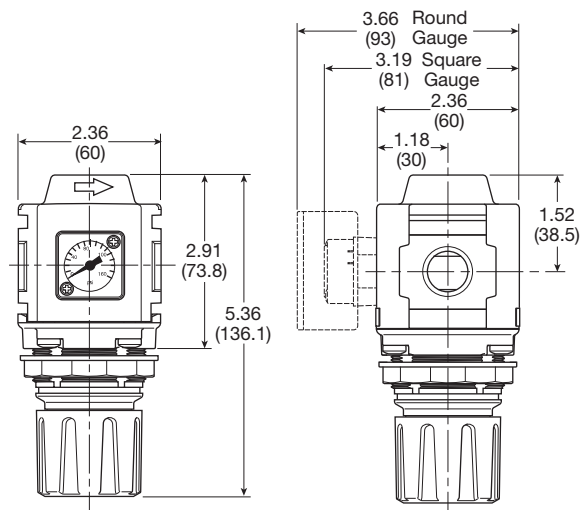

Inches (mm)

NOTE: 1.90 in. (48mm) hole required for panel nut mounting.

Flow Charts

P32RB 1/4" Regulator

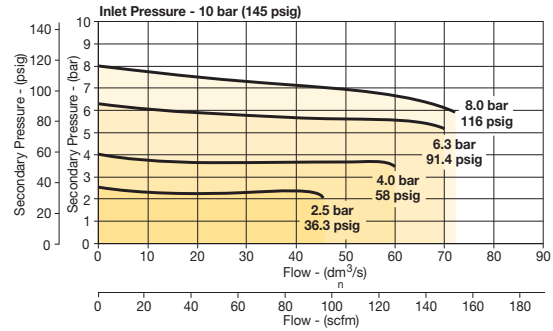

P32RB 3/8" Regulator

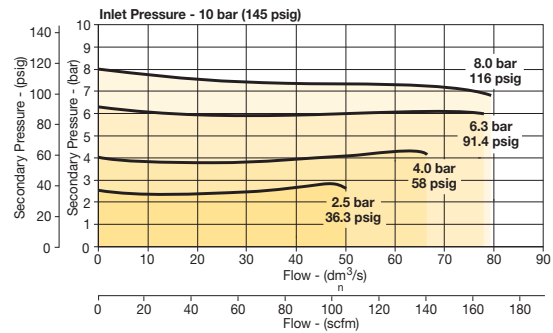

P32RB 1/2" Regulator

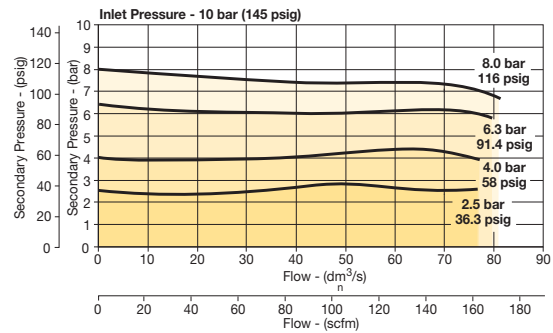

Gauges

Square flush mount gauge	0-4 bar	K4511SCR04B
	0-11 bar	K4511SCR11B
	0-60 psig	K4511SCR060
	0-160 psig	K4511SCR160
Square with adapter kit	0-4 bar	P6G-PR10040
	0-11 bar	P6G-PR10110
	0-60 psig	P6G-PR90060
	0-160 psig	P6G-PR90160
50mm (2") round 1/4" center back mount	0-30 psig / 0-2 bar	K4520N14030
	0-60 psig / 0-4 bar	K4520N14060
	0-160 psig / 0-11 bar	K4520N14160
	0-300 psig / 0-20 bar	K4520N14300

For best performance, regulated pressure should always be set by increasing the pressure up to the desired setting.



For inventory, lead time, and kit lookup, visit www.pdnplu.com

P32 Semi-Precision Regulator – Compact

- Integral 1/4", 3/8" or 1/2" ports (NPT, BSPP & BSPT)
- Robust but lightweight aluminum construction
- Secondary pressure ranges
- Secondary aspiration plus balanced poppet provides quick response and accurate pressure regulation
- Relieving & non-relieving types
- Non-rising knob

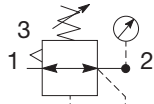

Self relieving regulator with gauge

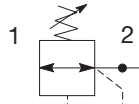

Non-relieving regulator

Port size	Description (relieving)	Gauge	Part number
1/4"	125 psig (8 bar)	None	P32RB92PNNP
1/4"	125 psig (8 bar)	Round	P32RB92PNGP
3/8"	125 psig (8 bar)	None	P32RB93PNNP
3/8"	125 psig (8 bar)	Round	P32RB93PNGP
1/2"	125 psig (8 bar)	None	P32RB94PNNP
1/2"	125 psig (8 bar)	Round	P32RB94PNGP

Operating information

Flow capacity*:	53 scfm (25 dm ³ /s, ANR)
Effect of supply pressure variation:	0.6 psig (0.04 bar) for 25 psig (1.7 bar) change in P1
Operating temperature:	-13°F to 150°F (-25°C to 65.5°C)
Supply pressure (max):	300 psig (20 bar)
Adjusting range pressure:	0 to 30 psig (0 to 2 bar) 0 to 60 psig (0 to 4 bar) 0 to 125 psig (0 to 8 bar) 0 to 250 psig (0 to 17 bar)
Gauge port (2 each):	1/4 NPT, BSPP, BSPT
Weight:	0.90 lb (0.41 kg)

* Inlet pressure 145 psig (10 bar). Secondary pressure 91.3 psig (6.3 bar) and 14.5 psig (1 bar) pressure drop.

Ordering Information:

P32RB 9 6 P N G P

Basic series Global modular compact regulator P32RB	Thread type BSPP 1 BSPT 2 NPT 9	Port size 1/4 2 3/8 3 1/2 4	Relief Semi-precision relieving P Semi-precision non-relieving T	Mounting P Plastic panel mount nut	Adjustment range																								
					<table border="1"> <thead> <tr> <th colspan="2">With square gauge</th> <th colspan="2">With round gauge</th> </tr> <tr> <th>psig</th> <th>bar</th> <th></th> <th></th> </tr> </thead> <tbody> <tr> <td>1 = 30*</td> <td>V = 2*</td> <td>Z</td> <td>30 psig; 2 bar; 0.2 MPa</td> </tr> <tr> <td>3 = 60</td> <td>S = 4</td> <td>M</td> <td>60 psig; 4 bar; 0.4 MPa</td> </tr> <tr> <td>5 = 125</td> <td>T = 8</td> <td>G</td> <td>125 psig; 8 bar; 0.8 MPa</td> </tr> <tr> <td></td> <td></td> <td>J</td> <td>250 psig; 17 bar; 1.7 MPa</td> </tr> </tbody> </table>	With square gauge		With round gauge		psig	bar			1 = 30*	V = 2*	Z	30 psig; 2 bar; 0.2 MPa	3 = 60	S = 4	M	60 psig; 4 bar; 0.4 MPa	5 = 125	T = 8	G	125 psig; 8 bar; 0.8 MPa			J	250 psig; 17 bar; 1.7 MPa
With square gauge		With round gauge																											
psig	bar																												
1 = 30*	V = 2*	Z	30 psig; 2 bar; 0.2 MPa																										
3 = 60	S = 4	M	60 psig; 4 bar; 0.4 MPa																										
5 = 125	T = 8	G	125 psig; 8 bar; 0.8 MPa																										
		J	250 psig; 17 bar; 1.7 MPa																										
					<table border="1"> <thead> <tr> <th colspan="2">Without gauge</th> </tr> <tr> <th></th> <th></th> </tr> </thead> <tbody> <tr> <td>Y</td> <td>30 psig; 2 bar; 0.2 MPa</td> </tr> <tr> <td>L</td> <td>60 psig; 4 bar; 0.4 MPa</td> </tr> <tr> <td>N</td> <td>125 psig; 8 bar; 0.8 MPa</td> </tr> <tr> <td>H</td> <td>250 psig; 17 bar; 1.7 MPa</td> </tr> </tbody> </table>	Without gauge				Y	30 psig; 2 bar; 0.2 MPa	L	60 psig; 4 bar; 0.4 MPa	N	125 psig; 8 bar; 0.8 MPa	H	250 psig; 17 bar; 1.7 MPa												
Without gauge																													
Y	30 psig; 2 bar; 0.2 MPa																												
L	60 psig; 4 bar; 0.4 MPa																												
N	125 psig; 8 bar; 0.8 MPa																												
H	250 psig; 17 bar; 1.7 MPa																												
				Adjustment N Non-rising knob T T-Handle																									

* Regulator comes with gauge respective to the adjustment range selected.

Most popular.



For inventory, lead times, and kit lookup, visit www.pdnplu.com

Material Specifications

Body	Aluminum
Adjustment knob	Acetal
Bonnet	Glass-filled nylon
Diaphragm assembly	Nitrile / zinc
Valve assembly	Brass / nitrile
Springs	Steel, stainless steel
Seals	Nitrile
Panel nut	Acetal

Repair and Service Kits

Diaphragm repair kit - relieving	P32KB00RB
Diaphragm repair kit - non-relieving	P32KB00RC
Panel mount nut - aluminum	P32KA00MM
Panel mount nut - plastic	P32KA00MP
Angle bracket (attaches via panel nut)	P32KB00MR
T-bracket with body connector	P32KA00MT
T-bracket	P32KA00MB
Body connector	P32KA00CB

⚠ WARNING

**Product rupture can cause serious injury.
Do not connect regulator to bottled gas.
Do not exceed Maximum primary pressure rating.**

CAUTION:

REGULATOR PRESSURE ADJUSTMENT – The working range of knob adjustment is designed to permit outlet pressures within their full range. Pressure adjustment beyond this range is also possible because the knob is not a limiting device. This is a common characteristic of most industrial regulators, and limiting devices may be obtained only by special design. For best performance, regulated pressure should always be set by increasing the pressure up to the desired setting.

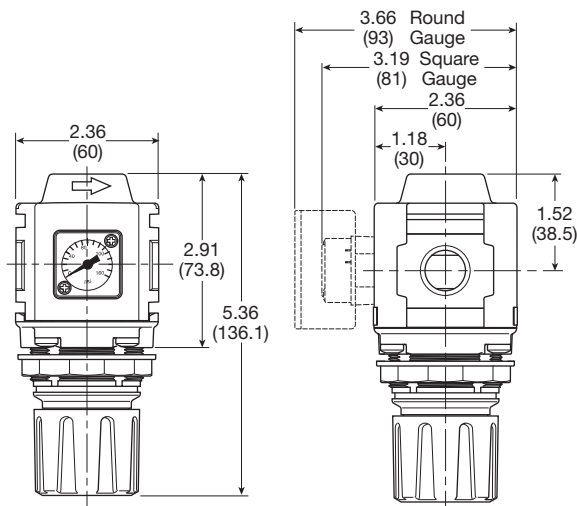

Inches (mm)

NOTE: 1.90 in. (48mm) hole required for panel nut mounting.

Flow Charts

P32RB 1/4" Regulator

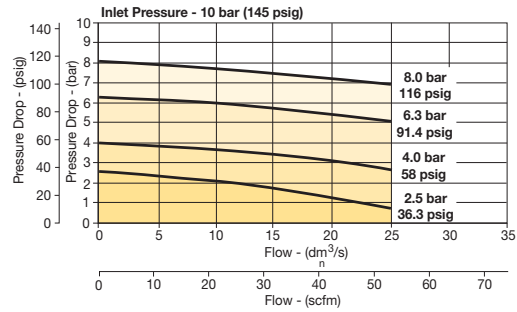

P32RB 3/8" Regulator

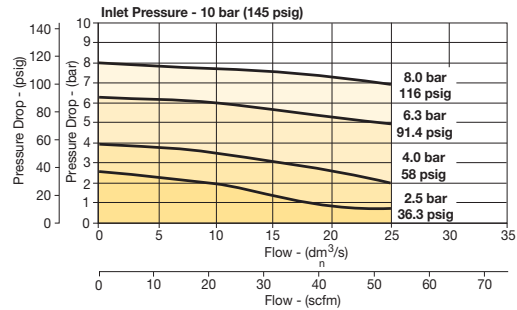

P32RB 1/2" Regulator

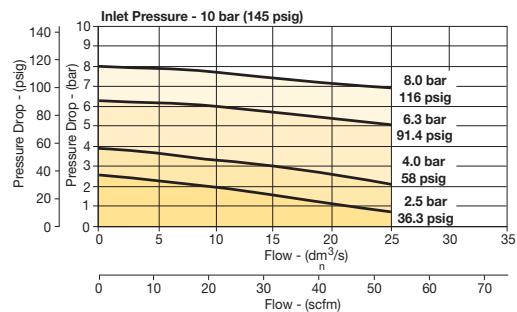

Gauges

Square flush mount gauge	0-4 bar	K4511SCR04B
	0-11 bar	K4511SCR11B
	0-60 psig	K4511SCR060
	0-160 psig	K4511SCR160
Square with adapter kit	0-4 bar	P6G-PR10040
	0-11 bar	P6G-PR10110
	0-60 psig	P6G-PR90060
	0-160 psig	P6G-PR90160
50mm (2") round 1/4" center back mount	0-30 psig / 0-2 bar	K4520N14030
	0-60 psig / 0-4 bar	K4520N14060
	0-160 psig / 0-11 bar	K4520N14160
	0-300 psig / 0-20 bar	K4520N14300

For best performance, regulated pressure should always be set by increasing the pressure up to the desired setting.



For inventory, lead time, and kit lookup, visit www.pdnplu.com

Compact Common P1 Precision Regulator

P32 Common - P1 Regulator – Compact

- Manifold style regulator with line pressure on both sides.
- Pressure output is at front or rear.
- Inlet ports 1/4", 3/8" or 1/2" (NPT, BSPP & BSPT)
- Working port 1/4"
- Robust construction
- Secondary pressure ranges
- Secondary aspiration plus balanced poppet provides quick response and accurate pressure regulation
- Relieving & non-relieving types
- Non-rising knob

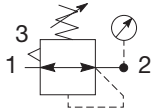
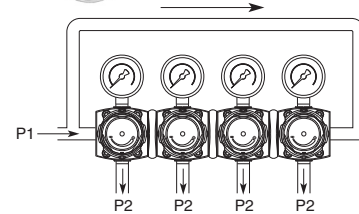

Self relieving regulator with gauge

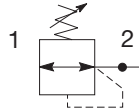

Non-relieving regulator

Port size	Description (relieving)	Gauge	Part number
1/4"	125 psig (8 bar)	None	P32HB92BNNP
3/8"	125 psig (8 bar)	None	P32HB93BNNP
1/2"	125 psig (8 bar)	None	P32HB94BNNP

Operating information

Flow capacity*:	1/4, 3/8, 1/2	64 scfm (30 dm ³ /s, ANR)
Operating temperature:		-25°C to 65.5°C (-13°F to 150°F)
Supply pressure (max):		300 psig (20 bar)
Adjusting range pressure:		0 to 30 psig (0 to 2 bar) 0 to 60 psig (0 to 4 bar) 0 to 125 psig (0 to 8 bar) 0 to 232 psig (0 to 16 bar)
Gauge port (2 each):		1/4 NPT, BSPP, BSPT
Weight:		0.50 lb (1.10 kg)

* Inlet pressure 145 psig (10 bar). Secondary pressure 91.3 psig (6.3 bar) and 14.5 psig (1 bar) pressure drop.

Ordering Information:

P32HB 9 2 B N N P

Basic series

Global modular compact regulator **P32HB**

Thread type

BSPP 1
BSPT 2
NPT 9

Port size †

1/4 2
3/8 3
1/2 4

† Working port 1/4".

Relief

Relieving B
Non-relieving N

Mounting

P Plastic panel mount nut

		Adjustment range	
		With square gauge	With round gauge
psig	bar		
1 = 30*	V = 2*	Z	30 psig; 2 bar; 0.2 MPa
3 = 60	S = 4	M	60 psig; 4 bar; 0.4 MPa
5 = 125	T = 8	G	125 psig; 8 bar; 0.8 MPa
		J	250 psig; 17 bar; 1.7 MPa
		Without gauge	
		Y	30 psig; 2 bar; 0.2 MPa
		L	60 psig; 4 bar; 0.4 MPa
		N	125 psig; 8 bar; 0.8 MPa
		H	250 psig; 17 bar; 1.7 MPa

* Regulator comes with gauge respective to the adjustment range selected.

Adjustment

N Non-rising knob
T T-Handle

Most popular.



For inventory, lead times, and kit lookup, visit www.pdnplu.com

Material Specifications

Body	Aluminum
Adjustment knob	Acetal
Bonnet	Glass-filled nylon
Diaphragm assembly	Nitrile / zinc
Valve assembly	Brass / nitrile
Springs	Steel, stainless steel
Seals	Nitrile
Panel nut	Acetal

Repair and Service Kits

Diaphragm repair kit - relieving	P32KB00RB
Diaphragm repair kit - non-relieving	P32KB00RC
Panel mount nut - aluminum	P32KA00MM
Panel mount nut - plastic	P32KA00MP
Angle bracket (attaches via panel nut)	P32KB00MR
T-bracket with body connector	P32KA00MT
T-bracket	P32KA00MB
Body connector	P32KA00CB

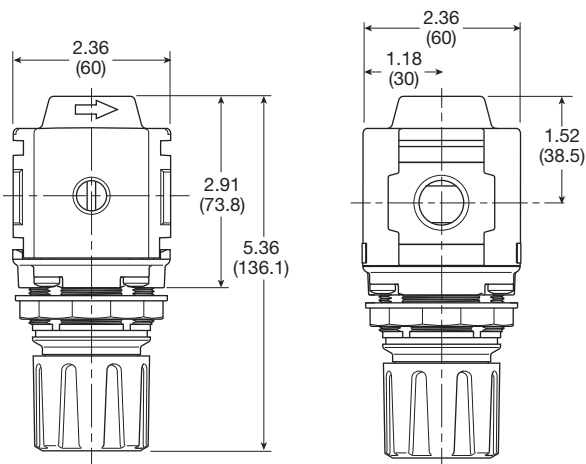

Inches (mm)

NOTE: 1.90 in. (48mm) hole required for panel nut mounting.

Flow Charts

P32HB Common Port Regulator

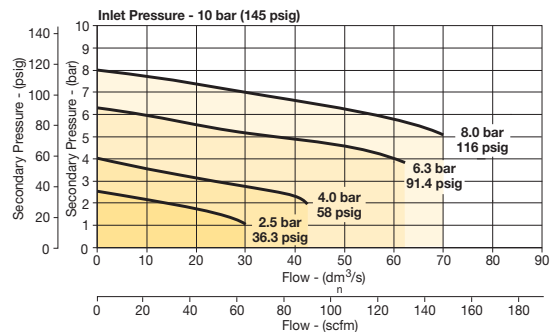

⚠ WARNING

**Product rupture can cause serious injury.
 Do not connect regulator to bottled gas.
 Do not exceed Maximum primary pressure rating.**

CAUTION:

REGULATOR PRESSURE ADJUSTMENT – The working range of knob adjustment is designed to permit outlet pressures within their full range. Pressure adjustment beyond this range is also possible because the knob is not a limiting device. This is a common characteristic of most industrial regulators, and limiting devices may be obtained only by special design. For best performance, regulated pressure should always be set by increasing the pressure up to the desired setting.

Gauges

Square flush mount gauge	0-4 bar	K4511SCR04B
	0-11 bar	K4511SCR11B
	0-60 psig	K4511SCR060
	0-160 psig	K4511SCR160
Square with adapter kit	0-4 bar	P6G-PR10040
	0-11 bar	P6G-PR10110
	0-60 psig	P6G-PR90060
	0-160 psig	P6G-PR90160
50mm (2") round 1/4" center back mount	0-30 psig / 0-2 bar	K4520N14030
	0-60 psig / 0-4 bar	K4520N14060
	0-160 psig / 0-11 bar	K4520N14160
	0-300 psig / 0-20 bar	K4520N14300

For best performance, regulated pressure should always be set by increasing the pressure up to the desired setting.



For inventory, lead time, and kit lookup, visit www.pdnplu.com

B	Global Air Preparation
Introduction	
Filters	
Coalescers	
Regulators	
Filter/Regulators	
Lubricators	
Combinations	
Accessories and Kits	

P33 Regulators – Standard

- Integral 1/2" or 3/4" ports (NPT, BSPP & BSPT)
- Robust but lightweight aluminum construction
- Secondary pressure ranges
- Secondary aspiration plus balanced poppet provides quick response and accurate pressure regulation
- Relieving & non-relieving types
- Non-rising knob

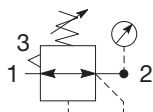

Self relieving regulator with gauge

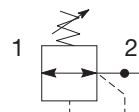

Non-relieving regulator

Operating information

Flow capacity*: 1/2, 3/4 233 scfm (110 dm³/s, ANR)
 Operating temperature: -13°F to 150°F (-25°C to 65.5°C)
 Supply pressure (max): 300 psig (20 bar)
 Adjusting range pressure: 0 to 30 psig (0 to 2 bar)
 0 to 60 psig (0 to 4 bar)
 0 to 125 psig (0 to 8 bar)
 0 to 250 psig (0 to 17 bar)
 Gauge port (2 each): 1/4 NPT, BSPP, BSPT
 Weight: 1.37 lb (0.62 kg)
 * Inlet pressure 145 psig (10 bar). Secondary pressure 91.3 psig (6.3 bar) and 14.5 psig (1 bar) pressure drop.

Port size	Description (relieving)	Gauge	Part number
1/2"	125 psig (8 bar)	None	P33RA94BNNP
1/2"	125 psig (8 bar)	Round	P33RA94BNGP
3/4"	125 psig (8 bar)	None	P33RA96BNNP
3/4"	125 psig (8 bar)	Round	P33RA96BNGP

Ordering Information:

P33RA 9 6 B N G P

- Basic series**
Global modular standard regulator **P33RA**
- Thread type**
BSPP 1
BSPT 2
NPT 9
- Port size**
1/2 4
3/4 6
- Relief**
Relieving **B**
Non-relieving **N**
Reverse flow-relieving **R**
- Adjustment**
Non-rising knob **N**
- Mounting**
P Plastic panel mount nut
- Adjustment range**

With round gauge	
Z	30 psig; 2 bar; 0.2 MPa
M	60 psig; 4 bar; 0.4 MPa
G	125 psig; 8 bar; 0.8 MPa
J	250 psig; 17 bar; 1.7 MPa
Without gauge	
Y	30 psig; 2 bar; 0.2 MPa
L	60 psig; 4 bar; 0.4 MPa
N	125 psig; 8 bar; 0.8 MPa
H	250 psig; 17 bar; 1.7 MPa

Most popular.



For inventory, lead times, and kit lookup, visit www.pdnplu.com

B30

Parker Hannifin Corporation
 Pneumatic Division
 Richland, Michigan
www.parker.com/pneumatics

Material Specifications

Body	Aluminum
Adjustment knob	Acetal
Body cap	ABS
Bonnet	Glass-filled nylon
Diaphragm assembly	Nitrile / zinc
Valve assembly	Brass / nitrile
Springs	Steel, stainless steel
Seals	Nitrile
Panel nut	Acetal

Repair and Service Kits

Diaphragm repair kit - relieving	P33KA00RB
Diaphragm repair kit - non-relieving	P33KA00RC
Panel mount nut - aluminum	P33KA00MM
Panel mount nut - plastic	P33KA00MP
Angle bracket (attaches via panel nut)	P33KA00MR
T-bracket with body connector	P32KA00MT
T-bracket	P32KA00MB
Body connector	P32KA00CB

WARNING

**Product rupture can cause serious injury.
 Do not connect regulator to bottled gas.
 Do not exceed Maximum primary pressure rating.**

CAUTION:

REGULATOR PRESSURE ADJUSTMENT – The working range of knob adjustment is designed to permit outlet pressures within their full range. Pressure adjustment beyond this range is also possible because the knob is not a limiting device. This is a common characteristic of most industrial regulators, and limiting devices may be obtained only by special design. For best performance, regulated pressure should always be set by increasing the pressure up to the desired setting.

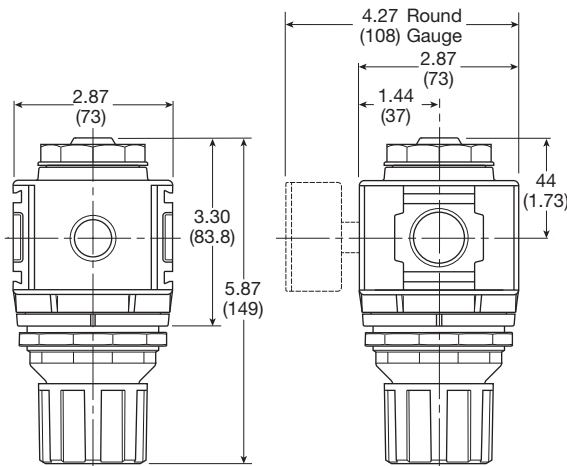

Inches (mm)

NOTE: 2.40 in. (61mm) hole required for panel nut mounting.

Flow Charts

P33RA 1/2" Regulator

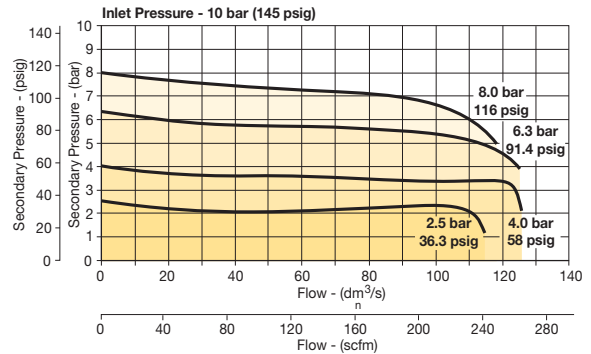

P33RA 3/4" Regulator

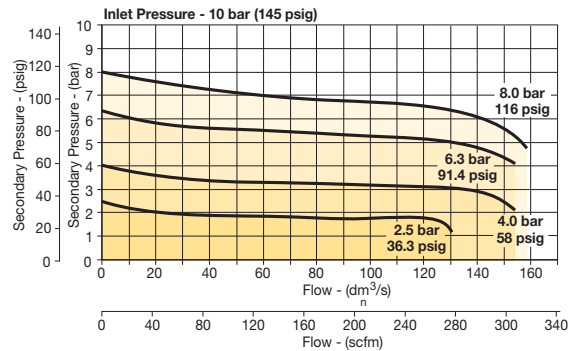

Gauges

50mm (2") round 1/4" center back mount	0-30 psig / 0-2 bar	K4520N14030
	0-60 psig / 0-4 bar	K4520N14060
	0-160 psig / 0-11 bar	K4520N14160
	0-300 psig / 0-20 bar	K4520N14300

For best performance, regulated pressure should always be set by increasing the pressure up to the desired setting.



For inventory, lead time, and kit lookup, visit www.pdnplu.com

P31P & P32P Proportional Regulators

- Very fast response times
- Accurate output pressure
- Parameter settings
- Selectable I/O parameters
- Quick, full flow exhaust
- LED display indicates output pressure
- No air consumption in steady state
- Multiple mounting options
- Protection to IP65



P31P Series
Bottom exhaust



P32P Series
Bottom exhaust

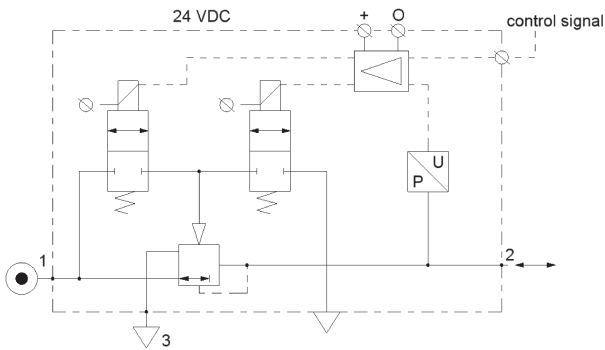

Port size	Description	Part number
1/4"	145 psig (0-10 bar), NC 0-10V	P31PA92AD2VD1
1/2"	145 psig (0-10 bar), NC 0-10V	P32PA92AD2VD1

Operating information

Flow capacity*:	P31P	40 scfm (19 dm ³ /s, ANR)
	P32P	120 scfm (57 dm ³ /s, ANR)
Temperature range:	32°F to 122°F (0°C to 50°C)	
Supply pressure (max):	2 bar unit	36.3 psig (2.5 bar)
	10 bar unit	152 psig (10.5 bar)
Operating pressure (min):	P2 pressure + 7.3 psig (0.5 bar)	
Working medium:	Compressed air or inert gasses, filtered to 40µ	
Pressure range:	0 to 30 psig (0 to 2 bar)	0 to 145 psig (0 to 10 bar)
Weight:	P31P	0.64 lb (0.291 kg)
	P32P	1.42 lb (0.645 kg)

* Inlet pressure 91.3 psig (6.3 bar), inlet pressure and 4.9 psig (0.34 bar) pressure drop.

Ordering Information:

P31PA 9 2 A D 2 V D 1

Body size	Thread type	Power supply	Control signal	Input connector
Global modular mini (1/4") P31PA	BSPP 1	2 24 volts	V 0-10V [†]	1 M12 (4-pin)
Global modular compact (1/2") P32PA	BSPT 2		‡ Factory setting is 0-10 V control signal. 4-20 mA control signal available via parameter 4 on keypad.	
	NPT 9			
Port size	Pressure range		Output signal	
Global modular mini (1/4") 2	Z 0 - 29 psig (0 - 2 bar)		D Digital, PNP	
Global modular compact (1/2") 4	D 0 - 145 psig (0 - 10 bar)		P PNP or 0-10V	
			N NPN or 0-10V	
			M 4-20mA fixed	
Version				
Bottom ported exhaust (NC) A				
Bottom ported forced exhaust (NO) [†] E				

† When the supply voltage is lost the unit will automatically exhaust the regulated pressure to 0 bar (atmospheric pressure)

D) Digital PNP output only, no analog output selectable
 P) Digital PNP and analogue 0-10V outputs selectable, by means of parameter 6. (Factory default 0-10V)
 N) Digital NPN and analog 0-10 V outputs selectable by means of parameter 6. Factory default 0-10V
 M) Analog 4-20mA output only.
 Note: On all analog outputs the F.S. value can be adjusted by means of parameter 8.

Most popular.



For inventory, lead times, and kit lookup, visit www.pdnplu.com

B32

Parker Hannifin Corporation
 Pneumatic Division
 Richland, Michigan
www.parker.com/pneumatics

Proportional Regulators

Technical Information

Accuracy

+/- 1.0% of F.S.*

* Full scale (F.S.) - For 2 bar (29 psig) versions this will be 2 bar (29 psig), for the 10 bar (145 psig) version full scale will be 10 bar (145 psig).

Air consumption

No consumption in stable regulated situation.

Display

The regulator is provided with a digital display, indicating the output pressure, either in bar or psig.

The factory setting is as indicated on the label, can be changed through to software at all times (parameter 14)

Supply voltage

24 VDC +/- 10%

Power consumption

Max. 1.1W with unloaded signal outputs

Control signals

The electronic pressure regulator can be externally controlled through an analogue control signal of either 0-10V or 4-20mA. (parameter 4).

Output signals

As soon as the output pressure is within the signal band a signal is given of 24VDC, PNP Ri = 1 kOhm
Outside the signal band this connection is 0V.

Connections

(In case of output signal (Option D)
Central M12 connector 4-pole
The electrical connections are as follows:

Pin No.	Function	Color
1	24 V Supply	Brown
2	0 to 10 V Control Signal Ri = 100k Ω	White
	4 to 20mA Control Signal Ri = 500 Ω	
3	0 V (GND) Supply	Blue
4	24 V Alarm Output Signal	Black

Air Preparation Products Global Air Preparation

Flow Charts

P31P Regulator 1/4" Ports

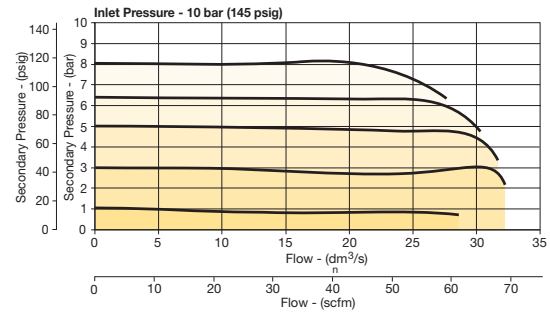

P32P Regulator 1/2" Ports

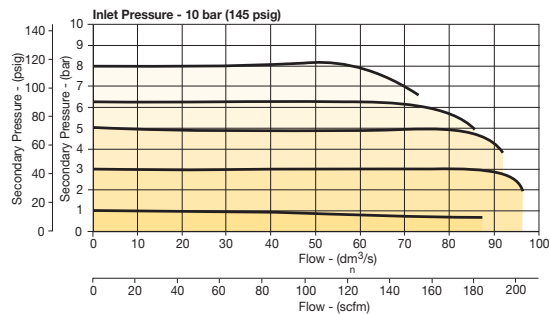

Degree of protection: IP65

EU conformity

CE: standard

EMC: according to directive 89/336/EEC

This pressure regulator is in accordance with:

EN 61000-6-1:2001

EN 61000-6-2:2001

EN 61000-6-3:2001

EN 61000-6-4:2001

Mounting position

Preferably vertical, with the cable gland on top.

Materials: P31P & P32P

Magnet core	Steel
Solenoid valve poppet	FPM
Solenoid valve housing	Techno polymer
Regulator body (P31P & P32P versions)	Aluminum
Regulator top housing	Nylon
Valve head	Brass & NBR
Remaining seals	NBR

B

Global Air Preparation

Introduction

Filters

Coalescers

Regulators

Filter/Regulators

Lubricators

Combinations

Accessories and Kits



For inventory, lead time, and kit lookup, visit www.pdnplu.com

B33

Parker Hannifin Corporation
Pneumatic Division
Richland, Michigan
www.parker.com/pneumatics

How to change parameters – How to Videos available at www.parker.com/pneu/propreg

Pressing the Accept key “acc” for more than 3 seconds, will activate parameter change mode. The user can then select the parameters by pressing up or down key (display will show Pxx). When parameter number is correct, pressing accept again will enter parameter number (display will show parameter value).

Pressing the up or down key will change the parameter itself (display will flash indicating parameter editing mode). Pressing the accept key will accept the new parameter value (all digits will flash whilst being accepted).

After releasing all keys, the next parameter number will be presented on the display (you may step to the next parameter). When no key is pressed, after 3 seconds the display will show the actual output pressure.

When the unit is initially powered up allow approximately 10 seconds for the unit to “boot-up” before changing parameter settings.

Only parameter numbers 0, 4, 6, 8, 9, 14, 18, 19, 20, 12, 13 and 21 are accessible to edit. All other parameters are fixed.

Manual mode:















When keys DOWN and UP are pressed during startup, (connecting to the 24V power supply) manual mode is activated. This means that the user is able to in/decrease the output pressure of the regulator, by pressing the UP or DOWN key. During this action the display will blink, indicating that the manual mode is activated. After powering up again, the unit will revert back to normal mode.

Back to Factory Setting

After start up. (Power is on)

Entering this value in parameter 0 will store the calibrated factory data into the working parameters. (Default calibration data is used)















Parameter Number 0 – Reset Back to Factory Settings

Step	1	2	3	4	5	
Press 	 3-6 seconds	 or 		 or 		
Until Display Reads			 Flashing Decimal	 Flashing Decimal	 Flashing	
Description	Accesses changeable parameters.	Accesses parameter no. 0.	Displays current parameter value.	Edits parameter. 3 = standard factory settings. If other than 3, use Up or Down Arrow and accept 3	Accepts and saves new parameter setting.	Sequences to next parameter.

Set Control Signal

The unit is factory set for 0-10 V control signal. If 4-20 mA control signal is required, change parameter 4.

Parameter Number 4 – Set Control Signal in Volts or Milliamps

Step	1	2	3	4	5	
Press 	 3-6 seconds	 or 		 or 		
Until Display Reads			 Flashing Decimal	 Flashing Decimal	 Flashing	
Description	Accesses changeable parameters.	Accesses parameter no. 4.	Displays current parameter value. 1 = V 0 = mA	Edits parameter.	Accepts and saves new parameter setting.	Sequences to next parameter.

How to Videos at www.parker.com/pneu/propreg

B

Global Air Preparation

Introduction

Filters

Coalescers

Regulators

Filter / Regulators

Lubricators

Combinations

Accessories and Kits



For inventory, lead times, and kit lookup, visit www.pdnplu.com

Set Output Signal

Parameter 6 is used to set the type of output signal to your PLC.
 This parameter is used as follows:

Output Signal option “0” = Digital Output – PNP

- Factory set at “0” Non Adjustable

Output Signal option “P” = Digital PNP or Analog 1-10V

- Factory set at “1” for Analog Signal
- Convert to Digital PNP by changing parameter to “0” setting











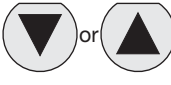

Output Signal option “N” = Digital NPN or Analog 1-10V

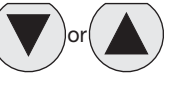
- Factory set at “1” Analog Signal
- Convert to Digital NPN by changing parameter to “0”

Output Signal option “M” = Analog 4-20 mA

- Factory set at “2” Non Adjustable

Parameter Number 6 – Set Output Signal

Step	1	2	3	4	5	
Press 	 3-6 seconds					
Until Display Reads			 Flashing Decimal	 Flashing Decimal (Value 0, 1 or 2)	 Flashing	
Description	Accesses changeable parameters.	Accesses parameter no. 6.	Displays current parameter value. 1 = m factory default for P3H with analog options	Edits parameter. 0 = digital (NPN or PNP) 1 = analog 0..10V 2 = analog 4..20 mA	Accepts and saves new parameter setting.	Sequences to next parameter.













Adjust Span Analog Output Signal

Set value is a % of Full Analog range. As an example for a 0-10V output signal, the original factory setting of 100% will give you an adjustment of 0-10V. If you reset Parameter 8 to 50%, the new output range would be 0-5V or 50% of the full range.

In the event that the output signal is to low, in a certain application, you can adjust it by increasing Parameter 8 to a maximum value of 130% of scale.

Note that all values are nominal and that an actual measurement may be required to ensure signal strength.

Parameter Number 8 – Adjust Span Analog Output Signal

Step	1	2	3	4	5	
Press 	 3-6 seconds					
Until Display Reads			 Flashing Decimal (For 2 bar versions value = 92)	 Flashing Decimal (Value between 0 and 130)	 Flashing	
Description	Accesses changeable parameters.	Accesses parameter no. 8.	Displays current parameter value.	Edits parameter.	Accepts and saves new parameter setting and implements the new analog signal span.	Sequences to next parameter.











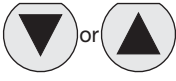

How to Videos at www.parker.com/pneu/propreg

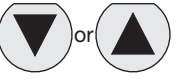

For inventory, lead time, and kit lookup, visit www.pdnplu.com











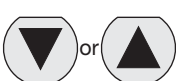

Adjust Digital Display

If necessary, adjustments can be made to the digital display when using an external pressure sensor.

Parameter Number 9 – Adjust Digital Display Value (Pressure Calibration)						
Step	1	2	3	4	5	
Press 	 3-6 seconds					
Until Display Reads			 Flashing Decimal	 Flashing Decimal	 Flashing	
Description	Accesses changeable parameters.	Accesses parameter no. 9.	Displays current digital display	Use up or down arrows and accept to adjust the display value if using an external pressure sensor.	Accepts and saves new parameter setting.	Sequences to next parameter.

Set Pressure Scale

Units with NPT port threads are supplied with a factory set psig pressure scale. Use parameter 14 to change scale to bar.

Parameter Number 14 – Set Pressure Scale in psig or bar						
Step	1	2	3	4	5	
Press 	 3-6 seconds					
Until Display Reads			 Flashing Decimal	 Flashing Decimal	 Flashing	
Description	Accesses changeable parameters.	Accesses parameter no. 14.	Displays current parameter value. 1 = psig 0 = bar 2 = MPa	Edits parameter.	Accepts and saves new parameter setting.	Sequences to next parameter.

How to Videos at www.parker.com/pneu/propreg











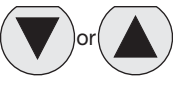

For inventory, lead times, and kit lookup, visit www.pdnplu.com

B
Global Air Preparation
Introduction
Filters
Coalescers
Regulators
Filter / Regulators
Lubricators
Combinations
Accessories and Kits

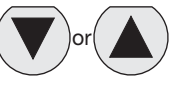
Preset Minimum Pressure

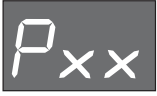
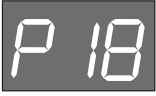
If there is a need for a pre-set Minimum pressure, use parameter 18. (Note: preset pressure is affected by % P19.)

Parameter Number 18 – Set Minimum Preset Pressure

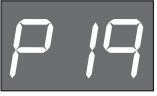
Step	1	2	3	4	5	
Press 	 3-6 seconds					
Until Display Reads			 Flashing Decimal	 Flashing Decimal (value between 0 and 200)	 Flashing	
Description	Accesses changeable parameters.	Accesses parameter no. 18.	Displays current parameter value. Incremental value is: <u>2 bar unit:</u> x 2 mbar x % P19 <u>10 bar unit:</u> x 10 mbar x % P19	Edits parameter.	Accepts and saves new parameter setting.	Sequences to next parameter.

Set Pressure Correction











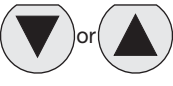

Pressure correction allows the user to set a Maximum pressure as a percentage of secondary pressure F.S.

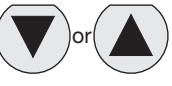
Example: If F.S. is 10 bar, set parameter 19 to 50 for Maximum preset pressure of 5 bar.

Pressure correction also affects the Minimum preset pressure in parameter 18.

Example: If F.S. is 10 bar and parameter 18 is set to a value of 100 (1 bar), and parameter 19 is set to 50%, then the actual Minimum preset pressure seen is 0.5 bar.

Parameter Number 19 – Set Maximum Preset Pressure

Step	1	2	3	4	5	
Press 	 3-6 seconds					
Until Display Reads			 Flashing Decimal	 Flashing Decimal (value between 0 and 100)	 Flashing	
Description	Accesses changeable parameters.	Accesses parameter no. 19.	Displays current parameter value. Incremental value is: % of F.S.	Edits parameter.	Accepts and saves new parameter setting.	Sequences to next parameter.

How to Videos at www.parker.com/pneu/propreg













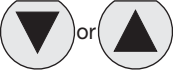

For inventory, lead time, and kit lookup, visit www.pdnplu.com

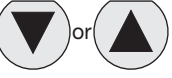
B
Global Air Preparation
Introduction
Filters
Coalescers
Regulators
Filter/Regulators
Lubricators
Combinations
Accessories and Kits

Behavior Control

The regulation speed of the pressure regulator can be modified by means of one parameter. (P 20)
The value in this parameter has a range from 0-5. A higher value indicates slower regulation speed, but will be more stable.

Parameter Number 20 – Set Behavior Control











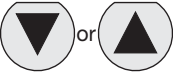

Step	1	2	3	4	5	
Press 	 3-6 seconds					
Until Display Reads			 Flashing Decimal	 Flashing Decimal (value between 0 and 5)	 Flashing	
Description	Accesses changeable parameters.	Accesses parameter no. 20.	Displays current parameter value.	Edits parameter 0 = custom set* 1 = fastest (narrow proportional band) 2 = fast 3 = normal 4 = slow 5 = slowest (proportional band is broad)	Accepts and saves new parameter setting.	Sequences to next parameter.

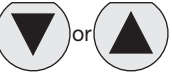
* When the value 0 is entered, you are able to create your own custom settings true parameters 12, 13 and 21.

**Fine Settings
Set Proportional Band**

Proportional band is used for setting the reaction sensitivity of the regulator. The displayed value is X 10 mbar and has a range between 50 (0.5 bar) and 250 (2.5 bar).

Parameter Number 12 – Set Proportional Band (P20 Must be Set to 0)

Step	1	2	3	4	5	
Press 	 3-6 seconds					
Until Display Reads			 Flashing Decimal	 Flashing Decimal (value between 50 and 250)	 Flashing	
Description	Accesses changeable parameters.	Accesses parameter no. 12.	Displays current parameter value. Incremental value is: x 10 mbar	Edits parameter.	Accepts and saves new parameter setting.	Sequences to next parameter.

How to Videos at www.parker.com/pneu/propreg













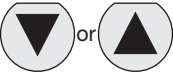

For inventory, lead times, and kit lookup, visit www.pdnplu.com

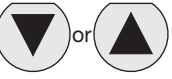
B
Global Air Preparation
Introduction
Filters
Coalescers
Regulators
Filter / Regulators
Lubricators
Combinations
Accessories and Kits

Set Deadband









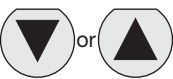

Deadband is the Minimum limit of accuracy at which the regulator is set for normal operation. The displayed value is X 10 mbar and has a range between 4 (40 mbar) and 40 (400 mbar).

Parameter Number 13 – Set Deadband (P20 Must be Set to 0)

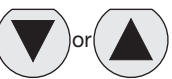



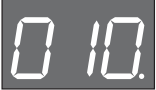

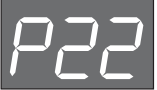
Step	1	2	3	4	5	
Press 	 3-6 seconds					
Until Display Reads			 Flashing Decimal	 Flashing Decimal (value between 4 and 40)	 Flashing	
Description	Accesses changeable parameters.	Accesses parameter no. 13.	Displays current parameter value. Incremental value is x 10 mbar	Edits parameter.	Accepts and saves new parameter setting.	Sequences to next parameter.

Proportional Effect

Parameter Number 21 – Set Proportional Effect (P20 Must be Set to 0)

Step	1	2	3	4	5	
Press 	 3-6 seconds					
Until Display Reads			 Flashing Decimal	 Flashing Decimal (value between 5 and 100)	 Flashing	
Description	Accesses changeable parameters.	Accesses parameter no. 21.	Displays current parameter value.	Edits parameter. 5 = fastest regulation 100 = slowest regulation.	Accepts and saves new parameter setting.	Sequences to next parameter.

Parameter Number 39 – Displays Current Software Version

Step	1	2	3	
Press 	 3-6 seconds			
Until Display Reads			 Flashing Decimal	
Description	Accesses changeable parameters.	Accesses parameter no. 39.	Displays current parameter value. XXX = current software version	

How to Videos at www.parker.com/pneu/propreg



For inventory, lead time, and kit lookup, visit www.pdnplu.com

P31P

Dimensions inches (mm)

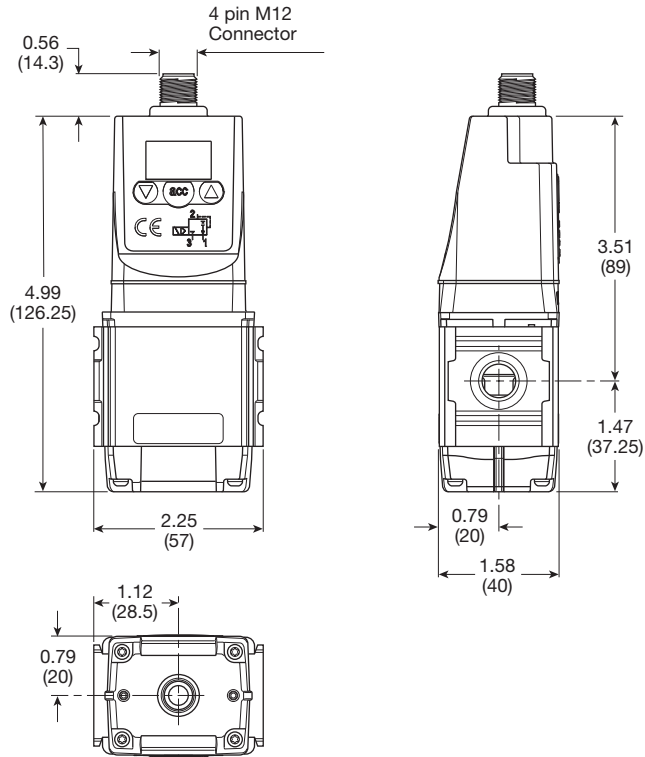

L-Bracket
P3HKA00ML

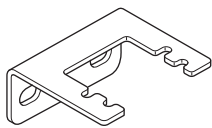
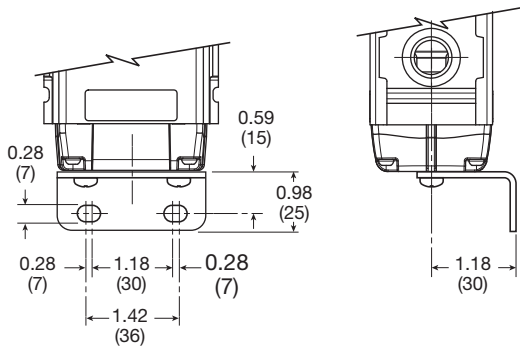

Foot Bracket
P3HKA00MC

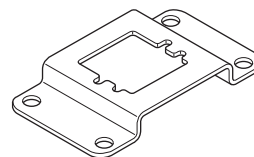
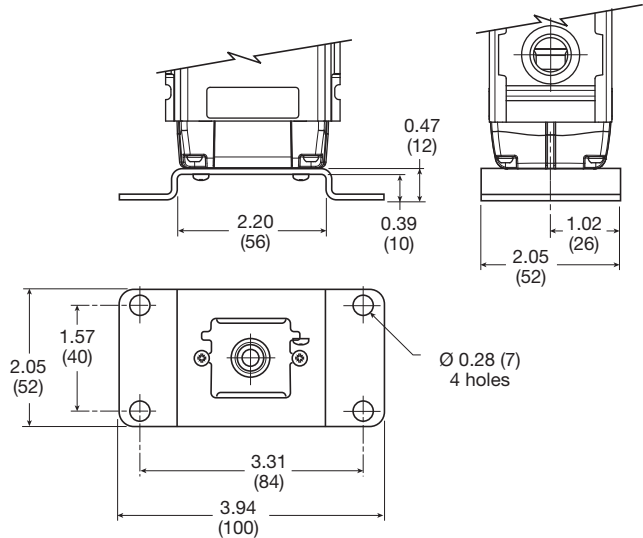

Cables

Description	Part number
2 mtr. cable with moulded straight M12x1 connector	CB-M12-4P-2M

Most popular.

B
Global Air Preparation
Introduction
Filters
Coalescers
Regulators
Filter / Regulators
Lubricators
Combinations
Accessories and Kits



For inventory, lead times, and kit lookup, visit www.pdnplu.com

P32P

Dimensions inches (mm)

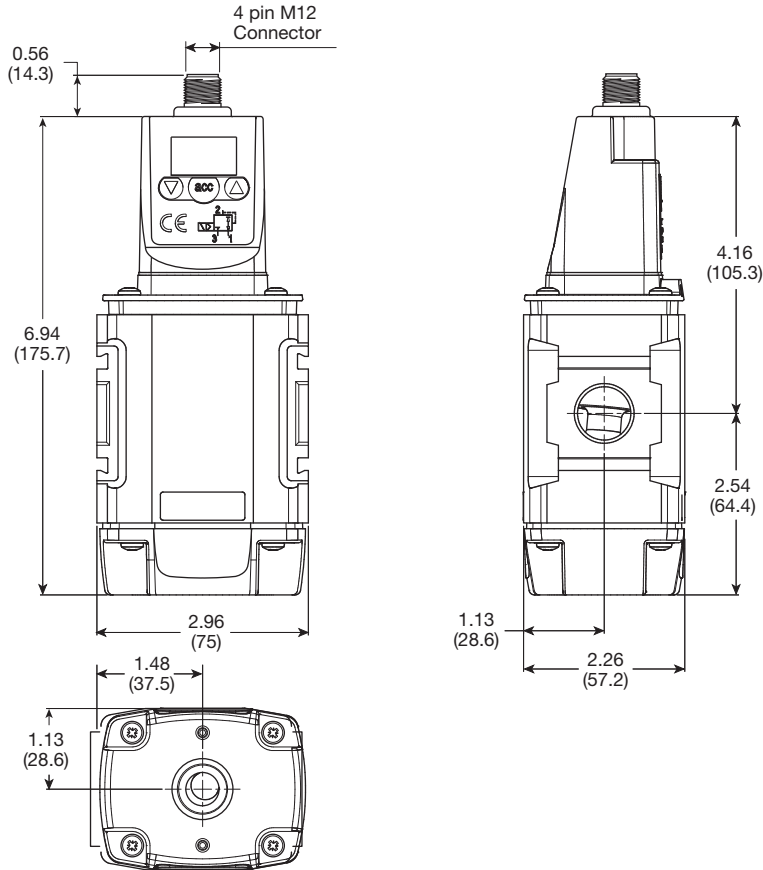

L-Bracket
P3KKA00ML

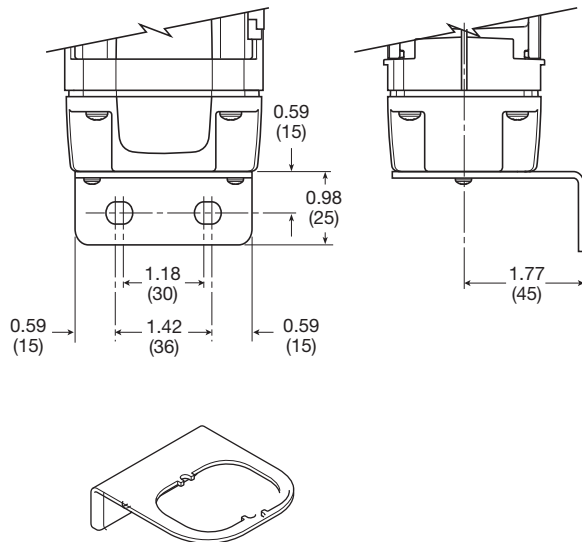

Foot Bracket
P3KKA00MC

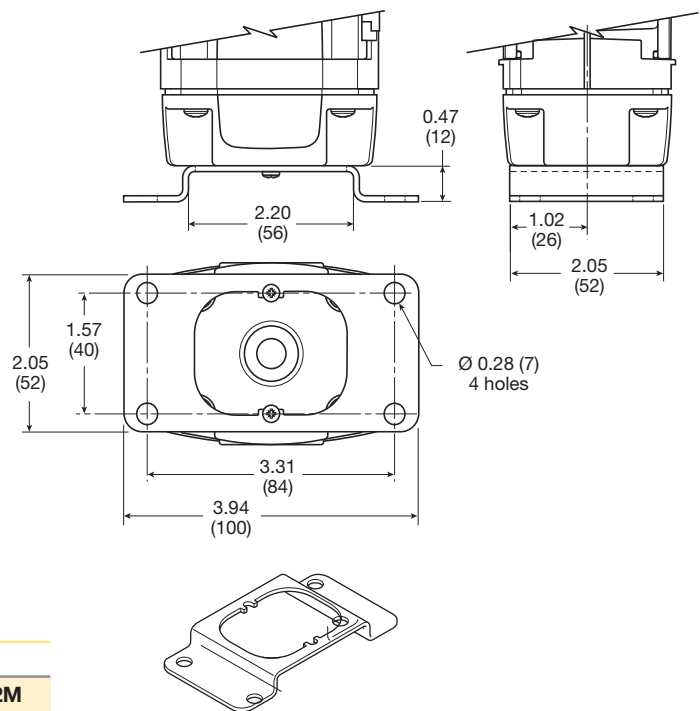

Cables

Description	Part number
2 mtr. cable with moulded straight M12x1 connector	CB-M12-4P-2M

Most popular.



For inventory, lead time, and kit lookup, visit www.pdnplu.com

P31 Filter / Regulators – Mini

- Integral 1/4" ports (NPT, BSPP & BSPT)
- High efficiency 5 micron element as standard
- Excellent water removal efficiency
- Robust but lightweight aluminum construction
- Positive bayonet latch to ensure correct & safe fitting
- Secondary pressure ranges
- Secondary aspiration plus balanced poppet provides quick response and accurate pressure regulation

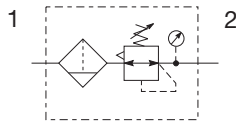

Port size	Description (relieving)	Bowl / drain type †	Part number
1/4"	125 psig (8 bar)	Poly / manual	P31EB92EGMBN5P
1/4"	125 psig (8 bar)	Poly / pulse	P31EB92EGBBN5P
1/4"	125 psig (8 bar)	Metal / manual	P31EB92EMMBN5P
1/4"	125 psig (8 bar)	Metal / pulse	P31EB92EMBBN5P

† For polycarbonate bowl, see caution in Engineering Section A.

Operating information

Flow capacity*:	1/4	73 scfm (35 dm ³ /s, ANR)
Operating temperature†:	Plastic bowl	14°F to 125°F (-10°C to 52°C)
	Metal bowl	14°F to 150°F (-10°C to 65.5°C)
Supply pressure (max):	Plastic bowl	150 psig (10 bar)
	Metal bowl	250 psig (17 bar)
Standard filtration		5 micron
Useful retention†:		0.4 US oz. (12 cm ³)
Adjusting range pressure:		0 to 30 psig (0 to 2 bar)
		0 to 60 psig (0 to 4 bar)
		0 to 125 psig (0 to 8 bar)
		0 to 250 psig (0 to 17 bar)
Gauge port (2 each)**:		1/8 NPT, BSPP, BSPT
Weight:		0.42 lb (0.19 kg)

* Inlet pressure 145 psig (10 bar). Secondary pressure 91.3 psig (6.3 bar) and 14.5 psig (1 bar) pressure drop.

** Non-gauge option only.

† Units with square gauges: 5°F to 150°F (-15°C to 65.5°C)

‡ Useful retention refers to volume below the quiet zone baffle.

Air quality: Within ISO 8573-1: 1991 Class 3 (Particulates)
 Within ISO 8573-1: 2001 Class 6 (Particulates)

Ordering Information:

P31EB 9 2 E G M B N 5 P

Basic series Global modular mini filter / regulator P31EB	Thread type BSPP 1 BSPT 2 NPT 9	Element 5µ Element E	Port size 1/4 2	Bowl type Poly bowl with bowl guard G Metal bowl without sight gauge M	Drain type Pulse drain B Manual drain M Flex drain X	Adjustment N Non-rising knob	Relief B Relieving N Non-relieving	Mounting p Plastic panel mount nut																																												
						<table border="1"> <thead> <tr> <th colspan="2">With square gauge</th> <th colspan="2">Adjustment range</th> </tr> <tr> <th>psig</th> <th>bar</th> <th colspan="2">With round gauge</th> </tr> </thead> <tbody> <tr> <td>1 = 30*</td> <td>V = 2*</td> <td>Z</td> <td>30 psig; 2 bar; 0.2 MPa</td> </tr> <tr> <td>3 = 60</td> <td>S = 4</td> <td>M</td> <td>60 psig; 4 bar; 0.4 MPa</td> </tr> <tr> <td>5 = 125</td> <td>T = 8</td> <td>G</td> <td>125 psig; 8 bar; 0.8 MPa</td> </tr> <tr> <td colspan="2"></td> <td>J[§]</td> <td>232 psig; 16 bar; 1.6 MPa</td> </tr> <tr> <td colspan="4" style="text-align: center;">Without gauge</td> </tr> <tr> <td colspan="2"></td> <td>Y</td> <td>30 psig; 2 bar; 0.2 MPa</td> </tr> <tr> <td colspan="2"></td> <td>L</td> <td>60 psig; 4 bar; 0.4 MPa</td> </tr> <tr> <td colspan="2"></td> <td>N</td> <td>125 psig; 8 bar; 0.8 MPa</td> </tr> <tr> <td colspan="2"></td> <td>H[§]</td> <td>232 psig; 16 bar; 1.6 MPa</td> </tr> </tbody> </table>			With square gauge		Adjustment range		psig	bar	With round gauge		1 = 30*	V = 2*	Z	30 psig; 2 bar; 0.2 MPa	3 = 60	S = 4	M	60 psig; 4 bar; 0.4 MPa	5 = 125	T = 8	G	125 psig; 8 bar; 0.8 MPa			J [§]	232 psig; 16 bar; 1.6 MPa	Without gauge						Y	30 psig; 2 bar; 0.2 MPa			L	60 psig; 4 bar; 0.4 MPa			N	125 psig; 8 bar; 0.8 MPa			H [§]	232 psig; 16 bar; 1.6 MPa
With square gauge		Adjustment range																																																		
psig	bar	With round gauge																																																		
1 = 30*	V = 2*	Z	30 psig; 2 bar; 0.2 MPa																																																	
3 = 60	S = 4	M	60 psig; 4 bar; 0.4 MPa																																																	
5 = 125	T = 8	G	125 psig; 8 bar; 0.8 MPa																																																	
		J [§]	232 psig; 16 bar; 1.6 MPa																																																	
Without gauge																																																				
		Y	30 psig; 2 bar; 0.2 MPa																																																	
		L	60 psig; 4 bar; 0.4 MPa																																																	
		N	125 psig; 8 bar; 0.8 MPa																																																	
		H [§]	232 psig; 16 bar; 1.6 MPa																																																	

* Regulator comes with gauge respective to the adjustment range selected.
 § Not available with poly bowl with bowl guard.

Most popular.



For inventory, lead times, and kit lookup, visit www.pdnplu.com

B42

Parker Hannifin Corporation
 Pneumatic Division
 Richland, Michigan
www.parker.com/pneumatics

Material Specifications

Body	Aluminum
Adjustment knob	Acetal
Body cap	ABS
Bonnet	PBT
Plastic bowl	Polycarbonate
Metal bowl	Aluminum
Bowl guard	Nylon
Filter element	Polyethylene
Seals	Nitrile
Springs	Steel
Valve assembly	Brass / Nitrile
Diaphragm assembly	Brass / Nitrile
Panel nut	Acetal

⚠ WARNING

**Product rupture can cause serious injury.
 Do not connect regulator to bottled gas.
 Do not exceed Maximum primary pressure rating.**

CAUTION:

REGULATOR PRESSURE ADJUSTMENT – The working range of knob adjustment is designed to permit outlet pressures within their full range. Pressure adjustment beyond this range is also possible because the knob is not a limiting device. This is a common characteristic of most industrial regulators, and limiting devices may be obtained only by special design. For best performance, regulated pressure should always be set by increasing the pressure up to the desired setting.

Flow Charts

P31EB 1/4" Filter / Regulator

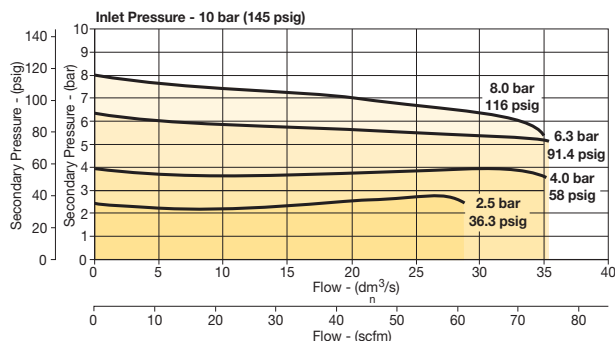

Repair and Service Kits

Plastic bowl / bowl guard manual drain	P31KB00BGM
Plastic bowl / bowl guard pulse drain	P31KB00BGB
Metal bowl / w/o sight gauge pulse drain	P31KB00BMB
5µ particle filter element	P31KA00ESE
Diaphragm repair kit - relieving	P31KB00RB
Diaphragm repair kit - non-relieving	P31KB00RC
Panel mount nut - aluminum	P31KA00MM
Panel mount nut - plastic	P31KA00MP
Angle bracket (attaches via panel nut)	P31KB00MR
C-bracket (fits to body)	P31KA00MW
T-bracket with body connector	P31KA00MT
Body connector	P31KA00CB

Gauges

Square flush mount gauge	0-4 bar	K4511SCR04B
	0-11 bar	K4511SCR11B
	0-60 psig	K4511SCR060
	0-160 psig	K4511SCR160

For best performance, regulated pressure should always be set by increasing the pressure up to the desired setting.

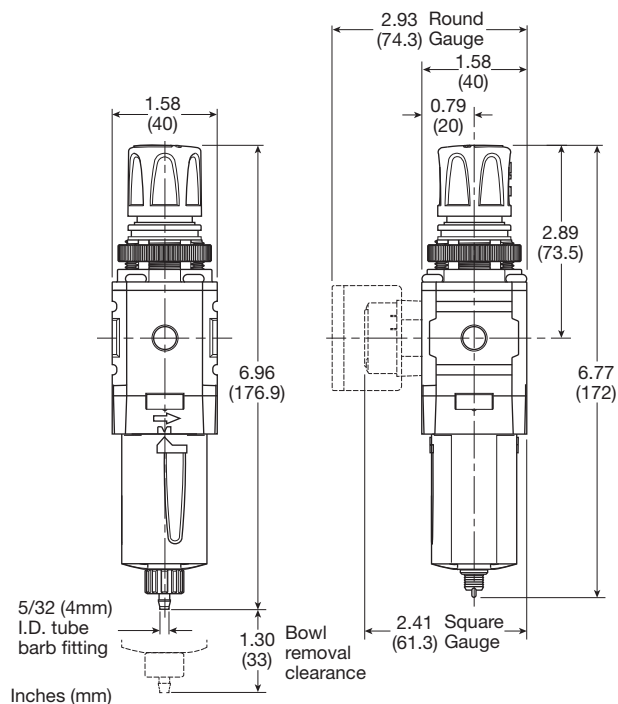

Manual Drain

Pulse Drain



For inventory, lead time, and kit lookup, visit www.pdnplu.com

B	Global Air Preparation
Introduction	
Filters	
Coalescers	
Regulators	
Filter / Regulators	
Lubricators	
Combinations	
Accessories and Kits	

P32 Filter / Regulators – Compact

- Integral 1/4", 3/8" or 1/2" ports (NPT, BSPP & BSPT)
- High efficiency 5 micron element as standard
- Excellent water removal efficiency
- Robust but lightweight aluminum construction
- Positive bayonet latch to ensure correct & safe fitting
- Secondary pressure ranges
- Secondary aspiration plus balanced poppet provides quick response and accurate pressure regulation

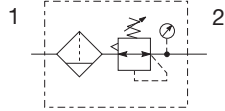

Port size	Description (relieving)	Bowl / drain type †	Part number
1/4"	125 psig (8 bar)	Poly / manual	P32EB92EGMBNGP
1/4"	125 psig (8 bar)	Poly / auto	P32EB92EGABNGP
1/4"	125 psig (8 bar)	Metal / manual	P32EB92ESMBNGP
1/4"	125 psig (8 bar)	Metal / auto	P32EB92ESABNGP
3/8"	125 psig (8 bar)	Poly / manual	P32EB93EGMBNGP
3/8"	125 psig (8 bar)	Poly / auto	P32EB93EGABNGP
3/8"	125 psig (8 bar)	Metal / manual	P32EB93ESMBNGP
3/8"	125 psig (8 bar)	Metal / auto	P32EB93ESABNGP
1/2"	125 psig (8 bar)	Poly / manual	P32EB94EGMBNGP
1/2"	125 psig (8 bar)	Poly / auto	P32EB94EGABNGP
1/2"	125 psig (8 bar)	Metal / manual	P32EB94ESMBNGP
1/2"	125 psig (8 bar)	Metal / auto	P32EB94ESABNGP

† For polycarbonate bowl, see caution in Engineering Section A.

Operating information

Flow capacity*:	1/4	148 scfm (70 dm ³ /s, ANR)
	3/8	158 scfm (75 dm ³ /s, ANR)
	1/2	164 scfm (77 dm ³ /s, ANR)
Operating temperature:		
Plastic bowl		-13°F to 125°F (-25°C to 52°C)
Metal bowl		-13°F to 150°F (-25°C to 65.5°C)
Supply pressure (max):		
Plastic bowl		150 psig (10 bar)
Metal bowl		250 psig (17 bar)
Standard filtration:		5 micron
Useful retention†:		1.7 US oz. (51 cm ³)
Adjusting range pressure:		0 to 30 psig (0 to 2 bar) 0 to 60 psig (0 to 4 bar) 0 to 125 psig (0 to 8 bar) 0 to 250 psig (0 to 17 bar)
Gauge port (2 each):		1/4 NPT, BSPP, BSPT
Weight:		1.17 lb (0.53 kg)

* Inlet pressure 145 psig (10 bar). Secondary pressure 91.3 psig (6.3 bar) and 14.5 psig (1 bar) pressure drop.

† Useful retention refers to volume below the quiet zone baffle.

Air quality: Within ISO 8573-1: 1991 Class 3 (Particulates)
Within ISO 8573-1: 2001 Class 6 (Particulates)

Ordering Information:

P32EB	9	2	E	G	M	B	N	5	P																																								
Basic series Global modular compact filter / regulator P32EB	Thread type BSPP 1 BSPT 2 NPT 9	Port size 1/4 2 3/8 3 1/2 4	Element 5µ Element E	Bowl type Poly bowl with bowl guard G Metal bowl without sight gauge M Metal bowl with sight gauge S	Drain type Manual drain M Auto drain A Flex drain X	Adjustment N Non-rising knob T T-Handle	Relief B Relieving N Non-relieving	Adjustment range	Mounting P Plastic panel mount nut																																								
								<table border="1"> <thead> <tr> <th colspan="2">With square gauge</th> <th colspan="2">With round gauge</th> </tr> <tr> <th>psig</th> <th>bar</th> <th>Z</th> <th>With round gauge</th> </tr> </thead> <tbody> <tr> <td>1 = 30*</td> <td>V = 2*</td> <td>M</td> <td>30 psig; 2 bar; 0.2 MPa</td> </tr> <tr> <td>3 = 60</td> <td>S = 4</td> <td>G</td> <td>60 psig; 4 bar; 0.4 MPa</td> </tr> <tr> <td>5 = 125</td> <td>T = 8</td> <td>J[§]</td> <td>125 psig; 8 bar; 0.8 MPa</td> </tr> <tr> <td colspan="4">Without gauge</td> </tr> <tr> <td colspan="2"></td> <td>Y</td> <td>30 psig; 2 bar; 0.2 MPa</td> </tr> <tr> <td colspan="2"></td> <td>L</td> <td>60 psig; 4 bar; 0.4 MPa</td> </tr> <tr> <td colspan="2"></td> <td>N</td> <td>125 psig; 8 bar; 0.8 MPa</td> </tr> <tr> <td colspan="2"></td> <td>H[§]</td> <td>250 psig; 17 bar; 1.7 MPa</td> </tr> </tbody> </table>	With square gauge		With round gauge		psig	bar	Z	With round gauge	1 = 30*	V = 2*	M	30 psig; 2 bar; 0.2 MPa	3 = 60	S = 4	G	60 psig; 4 bar; 0.4 MPa	5 = 125	T = 8	J [§]	125 psig; 8 bar; 0.8 MPa	Without gauge						Y	30 psig; 2 bar; 0.2 MPa			L	60 psig; 4 bar; 0.4 MPa			N	125 psig; 8 bar; 0.8 MPa			H [§]	250 psig; 17 bar; 1.7 MPa	
With square gauge		With round gauge																																															
psig	bar	Z	With round gauge																																														
1 = 30*	V = 2*	M	30 psig; 2 bar; 0.2 MPa																																														
3 = 60	S = 4	G	60 psig; 4 bar; 0.4 MPa																																														
5 = 125	T = 8	J [§]	125 psig; 8 bar; 0.8 MPa																																														
Without gauge																																																	
		Y	30 psig; 2 bar; 0.2 MPa																																														
		L	60 psig; 4 bar; 0.4 MPa																																														
		N	125 psig; 8 bar; 0.8 MPa																																														
		H [§]	250 psig; 17 bar; 1.7 MPa																																														

Most popular.



For inventory, lead times, and kit lookup, visit www.pdnplu.com

Material Specifications

Body	Aluminum
Adjustment knob	Acetal
Element retainer / baffle	Acetal
Plastic bowl	Polycarbonate
Metal bowl	Aluminum
Bowl guard	Nylon
Filter element	Sintered polyethylene
Seals	Nitrile
Springs	Steel, stainless steel
Valve assembly	Brass / nitrile
Diaphragm assembly	Nitrile / zinc
Panel nut	Acetal
Sight gauge	Nylon

Repair and Service Kits

Plastic bowl / bowl guard manual drain	P32KB00BGM
Metal bowl / sight gauge manual drain	P32KB00BSM
Auto drain	P32KA00DA
5µ particle filter element	P32KA00ESE
Diaphragm repair kit - relieving	P32KB00RB
Diaphragm repair kit - non-relieving	P32KB00RC
Panel mount nut - aluminum	P32KA00MM
Panel mount nut - plastic	P32KA00MP
Angle bracket (fits to panel mount threads)	P32KB00MR
T-bracket (fits to body connector)	P32KA00MB
T-bracket with body connector	P32KA00MT
Body connector	P32KA00CB

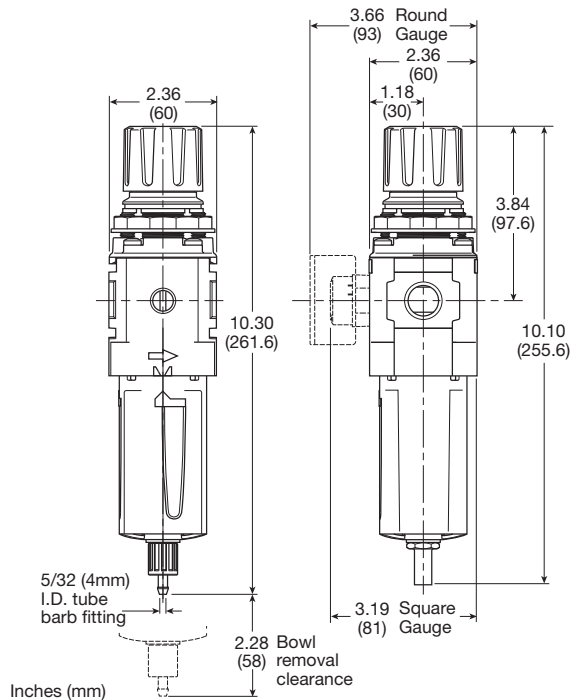

Flow Charts

P32EB 1/4" Filter / Regulator

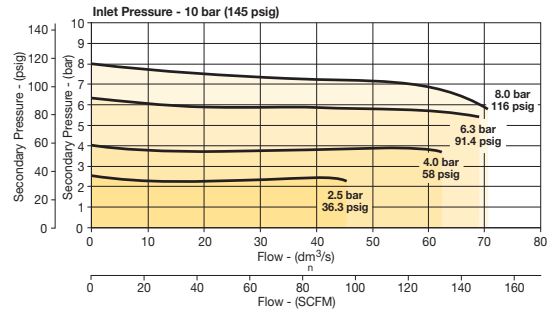

P32EB3/8" Filter/Regulator

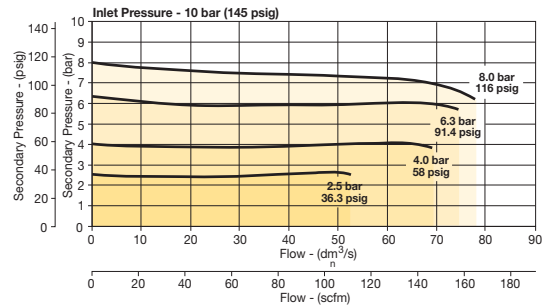

P32EB 1/2" Filter/Regulator

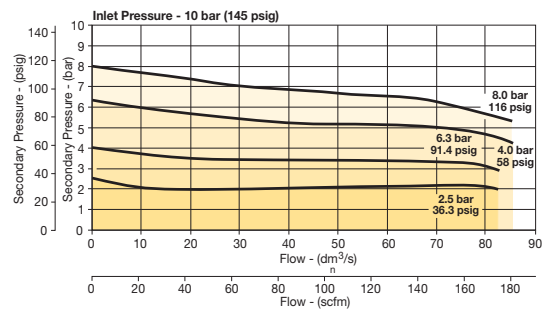

WARNING

Product rupture can cause serious injury.
Do not connect regulator to bottled gas.
Do not exceed Maximum primary pressure rating.

CAUTION:
REGULATOR PRESSURE ADJUSTMENT – The working range of knob adjustment is designed to permit outlet pressures within their full range. Pressure adjustment beyond this range is also possible because the knob is not a limiting device. This is a common characteristic of most industrial regulators, and limiting devices may be obtained only by special design. For best performance, regulated pressure should always be set by increasing the pressure up to the desired setting.

Gauges

50mm (2") round	0-30 psig / 0-2 bar	K4520N14030
1/4" center back mount	0-60 psig / 0-4 bar	K4520N14060
	0-160 psig / 0-11 bar	K4520N14160
	0-300 psig / 0-20 bar	K4520N14300

For best performance, regulated pressure should always be set by increasing the pressure up to the desired setting.

B

Global Air Preparation

Introduction

Filters

Coalescers

Regulators

Filter / Regulators

Lubricators

Combinations

Accessories and Kits



For inventory, lead time, and kit lookup, visit www.pdnplu.com

P32 Semi-Precision Filter / Regulators – Compact

- Integral 1/4", 3/8" or 1/2" ports (NPT, BSPP & BSPT)
- High efficiency 5 micron element as standard
- Excellent water removal efficiency
- Robust but lightweight aluminum construction
- Positive bayonet latch to ensure correct & safe fitting
- Secondary pressure ranges
- Secondary aspiration plus balanced poppet provides quick response and accurate pressure regulation

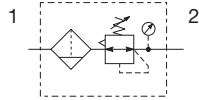

Port size	Description / relieving	Bowl / drain type †	Part number
1/4"	125 psig (8 bar)	Poly / manual	P32EB92EGMPNGP
1/4"	125 psig (8 bar)	Poly / auto	P32EB92EGAPNGP
1/4"	125 psig (8 bar)	Metal / manual	P32EB92ESMPNGP
1/4"	125 psig (8 bar)	Metal / auto	P32EB92ESAPNGP
3/8"	125 psig (8 bar)	Poly / manual	P32EB93EGMPNGP
3/8"	125 psig (8 bar)	Poly / auto	P32EB93EGAPNGP
3/8"	125 psig (8 bar)	Metal / manual	P32EB93ESMPNGP
3/8"	125 psig (8 bar)	Metal / auto	P32EB93ESAPNGP
1/2"	125 psig (8 bar)	Poly / manual	P32EB94EGMPNGP
1/2"	125 psig (8 bar)	Poly / auto	P32EB94EGAPNGP
1/2"	125 psig (8 bar)	Metal / manual	P32EB94ESMPNGP
1/2"	125 psig (8 bar)	Metal / auto	P32EB94ESAPNGP

† For polycarbonate bowl, see caution in Engineering Section A.

Operating information

Flow capacity*: 1/4, 3/8, 1/2	75 scfm (35 dm ³ /s, ANR)
Effect of supply pressure variation	0.6 psig (0.04 bar) for 25 psig (1.7 bar) change in P1
Operating temperature:	
Plastic bowl	-13°F to 125°F (-25°C to 52°C)
Metal bowl	-13°F to 150°F (-25°C to 65.5°C)
Supply pressure (max):	
Plastic bowl	150 psig (10 bar)
Metal bowl	250 psig (17 bar)
Standard filtration:	5 micron
Useful retention [†] :	1.7 US oz. (51 cm ³)
Adjusting range pressure:	0 to 30 psig (0 to 2 bar) 0 to 60 psig (0 to 4 bar) 0 to 125 psig (0 to 8 bar) 0 to 250 psig (0 to 17 bar)
Gauge port (2 each):	1/4 NPT, BSPP, BSPT
Weight:	0.53 lb (1.17 kg)

* Inlet pressure 145 psig (10 bar). Secondary pressure 91.3 psig (6.3 bar) and 14.5 psig (1 bar) pressure drop.

† Useful retention refers to volume below the quiet zone baffle.

Air quality: Within ISO 8573-1: 1991 Class 3 (Particulates)
Within ISO 8573-1: 2001 Class 6 (Particulates)

Ordering Information:

P32EB		9	2	E	G	M	P	N	G	P	
Basic series	Global modular compact filter / regulator	Thread type	BSPP 1 BSPT 2 NPT 9	Element	5µ Element E	Port size	1/4 2 3/8 3 1/2 4	Adjustment	N Non-rising knob T T-Handle	Mounting	p Plastic panel mount nut
						Bowl type	Poly bowl with bowl guard G Metal bowl without sight gauge M Metal bowl with sight gauge S	Relief	P Semi-Precision Relieving T Semi-Precision Non-relieving		
										Adjustment range	
										With square gauge	With round gauge
										psig	bar
										1 = 30*	V = 2*
										3 = 60	S = 4
										5 = 125	T = 8
											Z 30 psig; 2 bar; 0.2 MPa
											M 60 psig; 4 bar; 0.4 MPa
											G 125 psig; 8 bar; 0.8 MPa
											J [§] 250 psig; 17 bar; 1.7 MPa
											Without gauge
											Y 30 psig; 2 bar; 0.2 MPa
											L 60 psig; 4 bar; 0.4 MPa
											N 125 psig; 8 bar; 0.8 MPa
											H [§] 250 psig; 17 bar; 1.7 MPa

* Regulator comes with gauge respective to the adjustment range selected.
§ Not available with poly bowl with bowl guard.

Most popular.



For inventory, lead times, and kit lookup, visit www.pdnplu.com

Material Specifications

Body	Aluminum
Adjustment knob	Acetal
Element retainer / baffle	Acetal
Plastic bowl	Polycarbonate
Metal bowl	Aluminum
Bowl guard	Nylon
Filter element	Sintered polyethylene
Seals	Nitrile
Springs	Steel, stainless steel
Valve assembly	Brass / nitrile
Diaphragm assembly	Nitrile / zinc
Panel nut	Acetal
Sight gauge	Nylon

Repair and Service Kits

Plastic bowl / bowl guard manual drain	P32KB00BGM
Metal bowl / sight gauge manual drain	P32KB00BSM
Auto drain	P32KA00DA
5µ particle filter element	P32KA00ESE
Diaphragm repair kit - relieving	P32KB00RB
Diaphragm repair kit - non-relieving	P32KB00RC
Panel mount nut - aluminum	P32KA00MM
Panel mount nut - plastic	P32KA00MP
Angle bracket (fits to panel mount threads)	P32KB00MR
T-bracket (fits to body connector)	P32KA00MB
T-bracket with body connector	P32KA00MT
Body connector	P32KA00CB

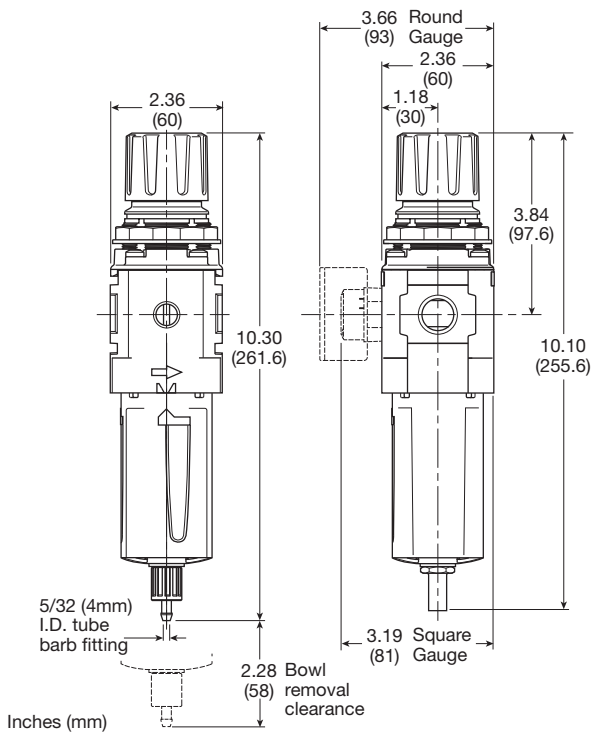

Manual Drain

Automatic Drain

Flow Charts

P32EB 1/4" Filter / Regulator

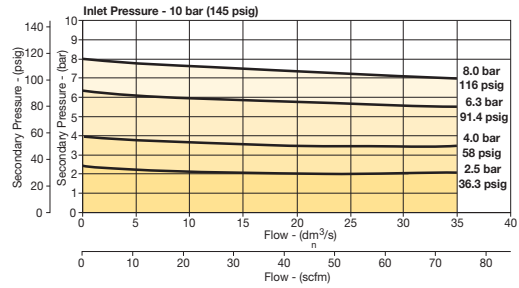

P32EB 3/8" Filter/Regulator

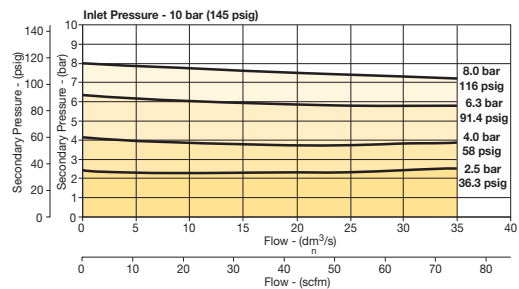

P32EB 1/2" Filter/Regulator

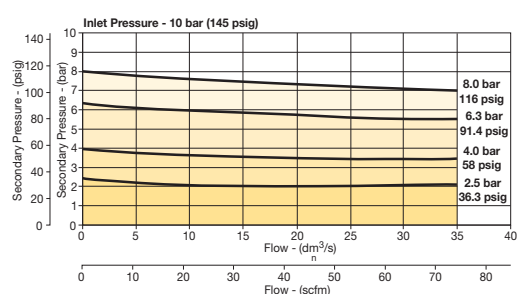

⚠ WARNING

**Product rupture can cause serious injury.
Do not connect regulator to bottled gas.
Do not exceed Maximum primary pressure rating.**

CAUTION:

REGULATOR PRESSURE ADJUSTMENT – The working range of knob adjustment is designed to permit outlet pressures within their full range. Pressure adjustment beyond this range is also possible because the knob is not a limiting device. This is a common characteristic of most industrial regulators, and limiting devices may be obtained only by special design. For best performance, regulated pressure should always be set by increasing the pressure up to the desired setting.

Gauges

50mm (2") round 1/4" center back mount	0-30 psig / 0-2 bar	K4520N14030
	0-60 psig / 0-4 bar	K4520N14060
	0-160 psig / 0-11 bar	K4520N14160
	0-300 psig / 0-20 bar	K4520N14300

For best performance, regulated pressure should always be set by increasing the pressure up to the desired setting.



For inventory, lead time, and kit lookup, visit www.pdnplu.com

P33 Filter / Regulators – Standard

- Integral 1/2" or 3/4" ports (NPT, BSPP & BSPT)
- High efficiency 5 micron element as standard
- Excellent water removal efficiency
- Robust but lightweight aluminum construction
- Positive bayonet latch to ensure correct & safe fitting
- Secondary pressure ranges
- Secondary aspiration plus balanced poppet provides quick response and accurate pressure regulation

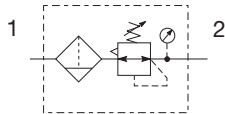

Port size	Description / relieving	Bowl / drain type †	Part number
1/2"	125 psig (8 bar)	Poly / manual	P33EA94EGMBNGP
1/2"	125 psig (8 bar)	Poly / auto	P33EA94EGABNGP
1/2"	125 psig (8 bar)	Metal / manual	P33EA94ESMBNGP
1/2"	125 psig (8 bar)	Metal / auto	P33EA94ESABNGP
3/4"	125 psig (8 bar)	Poly / manual	P33EA96EGMBNGP
3/4"	125 psig (8 bar)	Poly / auto	P33EA96EGABNGP
3/4"	125 psig (8 bar)	Metal / manual	P33EA96ESMBNGP
3/4"	125 psig (8 bar)	Metal / auto	P33EA96ESABNGP

† For polycarbonate bowl, see caution in Engineering Section A.

Operating information

Flow capacity*:	1/2	200 scfm (94 dm ³ /s, ANR)
	3/4	235 scfm (109 dm ³ /s, ANR)
Operating temperature:		
Plastic bowl		-13°F to 125°F (-25°C to 52°C)
Metal bowl		-13°F to 150°F (-25°C to 65.5°C)
Supply pressure (max):		
Plastic bowl		150 psig (10 bar)
Metal bowl		250 psig (17 bar)
Standard filtration:		5 micron
Useful retention†:		2.8 US oz. (85 cm ³)
Adjusting range pressure:		0 to 30 psig (0 to 2 bar)
		0 to 60 psig (0 to 4 bar)
		0 to 125 psig (0 to 8 bar)
		0 to 250 psig (0 to 17 bar)
Gauge port (2 each):		1/4 NPT, BSPP, BSPT
Weight:		1.87 psig (8 bar)

* Inlet pressure 145 psig (10 bar). Secondary pressure 91.3 psig (6.3 bar) and 14.5 psig (1 bar) pressure drop.
 † Useful retention refers to volume below the quiet zone baffle.

Air quality: Within ISO 8573-1: 1991 Class 3 (Particulates)
 Within ISO 8573-1: 2001 Class 6 (Particulates)

Ordering Information:

Basic series	Thread type	Element	Port size	Bowl type	Relief	Drain type	Adjustment	Mounting	Adjustment range
Global modular standard filter / regulator P33EA	BSPP 1 BSPT 2 NPT 9	5µ Element E	1/2 4 3/4 6	Poly bowl with bowl guard G Metal bowl without sight gauge M Metal bowl with sight gauge S	B Relieving N Non-relieving	M Manual drain A Auto drain	N Non-rising knob	P Plastic panel mount nut	With round gauge Z 30 psig; 2 bar; 0.2 MPa M 60 psig; 4 bar; 0.4 MPa G 125 psig; 8 bar; 0.8 MPa J [§] 250 psig; 17 bar; 1.7 MPa Without gauge Y 30 psig; 2 bar; 0.2 MPa L 60 psig; 4 bar; 0.4 MPa N 125 psig; 8 bar; 0.8 MPa H [§] 250 psig; 17 bar; 1.7 MPa

§ Not available with poly bowl with bowl guard.

Most popular.



For inventory, lead times, and kit lookup, visit www.pdnplu.com

B48

Parker Hannifin Corporation
 Pneumatic Division
 Richland, Michigan
www.parker.com/pneumatics

Material Specifications

Body	Aluminum
Adjustment knob	Acetal
Body cap	ABS
Element retainer / baffle	Acetal
Plastic bowl	Polycarbonate
Metal bowl	Aluminum
Filter element	Sintered Polyethylene
Seals	Nitrile
Springs	Steel, stainless steel
Valve assembly	Brass / nitrile
Diaphragm assembly	Nitrile / zinc
Panel nut	Acetal
Sight gauge	Nylon

Repair and Service Kits

Plastic bowl / bowl guard, manual drain	P33KA00BGM
Metal bowl / sight gauge, manual drain	P33KA00BSM
Auto drain	P32KA00DA
5µ particle filter element	P33KA00ESE
Diaphragm repair kit - Relieving	P33KA00RB
Diaphragm repair kit - Non-relieving	P33KA00RC
Panel mount nut - Aluminum	P33KA00MM
Panel mount nut - Plastic	P33KA00MP
Angle bracket (fits to panel mount threads)	P33KA00MR
T-bracket (fits to body connector)	P32KA00MB
T-bracket with body connector	P32KA00MT
Body connector	P32KA00CB

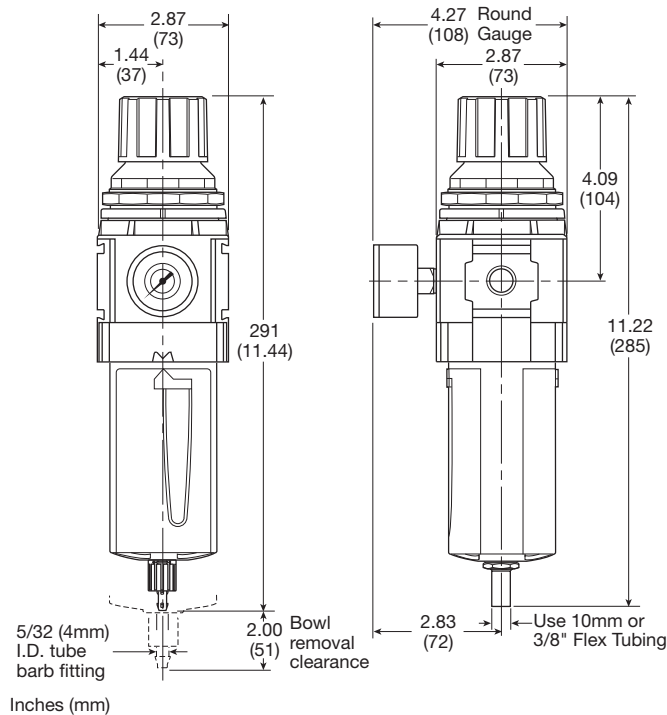

Flow Charts

P33EA 1/2" Filter / Regulator

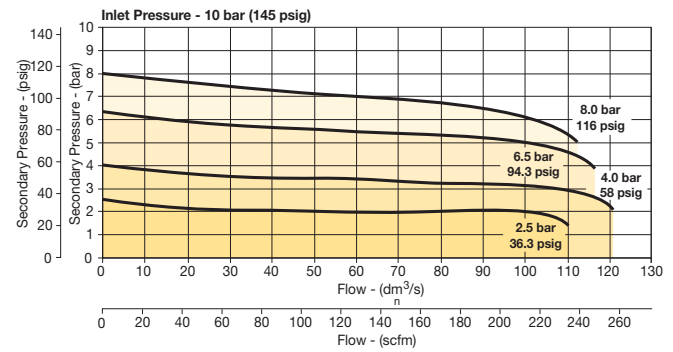

P33EA 3/4" Filter/Regulator

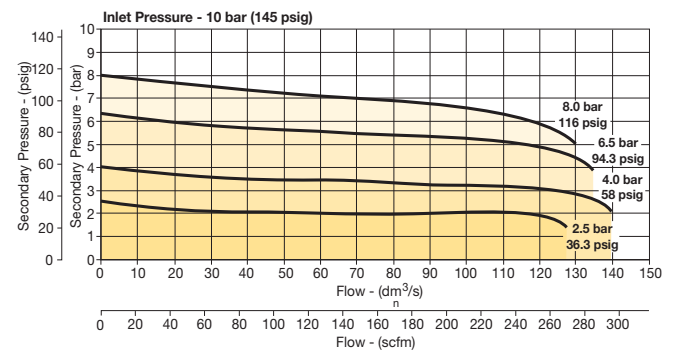

WARNING

Product rupture can cause serious injury.
Do not connect regulator to bottled gas.
Do not exceed Maximum primary pressure rating.

CAUTION:

REGULATOR PRESSURE ADJUSTMENT – The working range of knob adjustment is designed to permit outlet pressures within their full range. Pressure adjustment beyond this range is also possible because the knob is not a limiting device. This is a common characteristic of most industrial regulators, and limiting devices may be obtained only by special design. For best performance, regulated pressure should always be set by increasing the pressure up to the desired setting.

Gauges

50mm (2") round	0-30 psig / 0-2 bar	K4520N14030
1/4" center back mount	0-60 psig / 0-4 bar	K4520N14060
	0-160 psig / 0-11 bar	K4520N14160
	0-300 psig / 0-20 bar	K4520N14300

For best performance, regulated pressure should always be set by increasing the pressure up to the desired setting.

B
Global Air Preparation
Introduction
Filters
Coalescers
Regulators
Filter / Regulators
Lubricators
Combinations
Accessories and Kits



For inventory, lead time, and kit lookup, visit www.pdnplu.com

P31 Lubricators – Mini

- Integral 1/4" ports (NPT, BSPP & BSPT)
- Robust but lightweight aluminum construction
- Proportional oil delivery over a wide range of air flows
- Finger tip ratchet control for precise oil drip rate adjustment

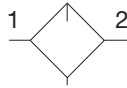

Lubricator with drain

Port size	Description †	Part number
1/4"	Poly bowl - No drain	P31LB92LGNN
1/4"	Metal bowl - No drain	P31LB92LMNN

† For polycarbonate bowl, see caution in Engineering Section A.

Operating information

Flow capacity*:	
1/4	52 scfm (25 dm ³ /s, ANR)
Operating temperature:	
Plastic bowl	14°F to 125°F (-10°C to 52°C)
Metal bowl	14°F to 150°F (-10°C to 65.5°C)
Supply pressure (max):	
Plastic bowl	150 psig (10 bar)
Metal bowl	250 psig (17 bar)
Bowl capacity:	0.6 US oz. (18 cm ³)
Weight:	0.29 lb (0.13 kg)
* Inlet pressure 91.3 psig (6.3 bar). Pressure drop 4.9 psig (0.34 bar).	

Ordering Information:

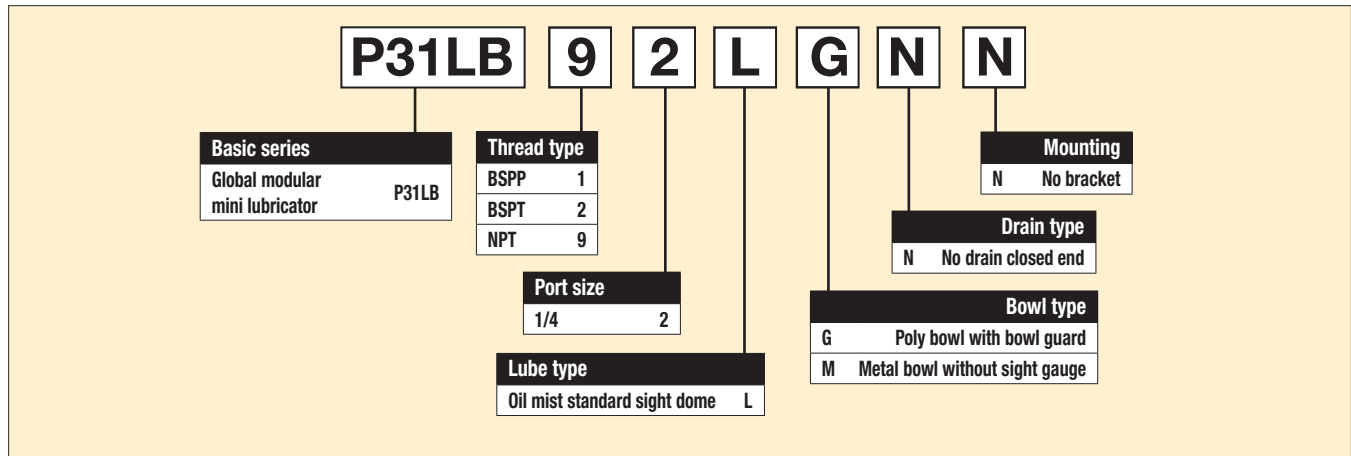

Suggested LubricantF442 Oil

Petroleum based oil of 100 to 200 SUS viscosity at 100°F (38°C) and an aniline point greater than 200°F (93°C)
 (DO NOT USE OILS WITH ADDITIVES, COMPOUNDED OILS CONTAINING SOLVENTS, GRAPHITE, DETERGENTS, OR SYNTHETIC OILS.)

Most popular.



For inventory, lead times, and kit lookup, visit www.pdnplu.com

B50

Parker Hannifin Corporation
 Pneumatic Division
 Richland, Michigan
www.parker.com/pneumatics

Material Specifications

Body	Aluminum
Body cap	ABS
Plastic bowl	Polycarbonate
Metal bowl	Aluminum
Seals	Nitrile
Sight dome	Polycarbonate
Suggested lubricant	ISO / ASTM VG32
Pick-up filter	Sintered bronze

Repair and Service Kits

Plastic bowl / bowl guard no drain	P31KB00BGN
Metal bowl / w/o sight gauge no drain	P31KB00BMN
Drip control assembly	P32KA00PG
Fill plug	P31KA00PL
C-bracket (fits to body)	P31KA00MW
T-bracket with body connector	P31KA00MT
Body connector	P31KA00CB
Oil (1 quart)	F442001
Oil (1 gallon)	F442002
Oil (12 quart case)	F442003
Oil (4 gallon case)	F442005

Flow Charts

P31LB 1/4" Lubricator

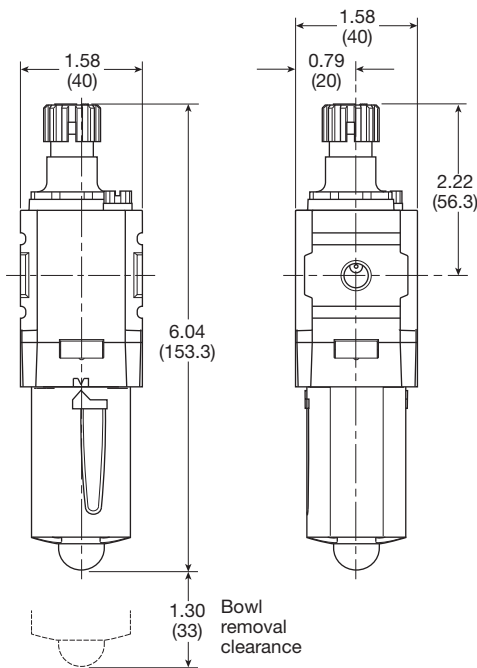
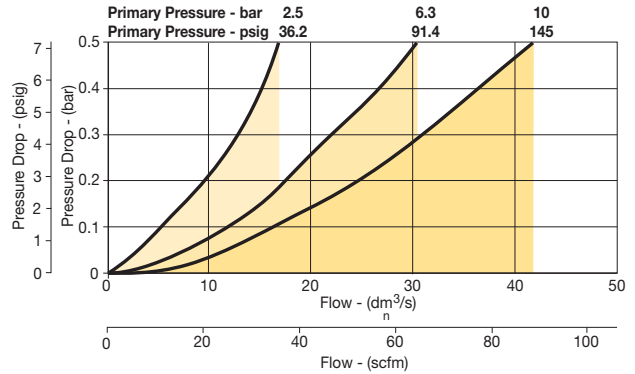

Inches (mm)

B

Global Air Preparation

Introduction

Filters

Coalescers

Regulators

Filter/Regulators

Lubricators

Combinations

Accessories and Kits



For inventory, lead time, and kit lookup, visit www.pdnplu.com

B51

Parker Hannifin Corporation
 Pneumatic Division
 Richland, Michigan
www.parker.com/pneumatics

P32 Lubricators – Compact

- Integral 1/4", 3/8" or 1/2" ports (NPT, BSPP & BSPT)
- Robust but lightweight aluminum construction
- Proportional oil delivery over a wide range of air flows
- Finger tip ratchet control for precise oil drip rate adjustment
- Fill from top under system pressure

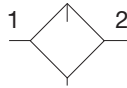

Lubricator with drain



Operating information

Flow capacity*:	
1/4	38 scfm (17 dm ³ /s, ANR)
3/8	70 scfm (33 dm ³ /s, ANR)
1/2	90 scfm (42 dm ³ /s, ANR)
Operating temperature:	
Plastic bowl	14°F to 125°F (-10°C to 52°C)
Metal bowl	14°F to 150°F (-10°C to 65.5°C)
Supply pressure (max):	
Plastic bowl	150 psig (10 bar)
Metal bowl	250 psig (17 bar)
Bowl capacity:	4.09 US oz. (121 cm ³)
Weight:	0.68 lb (0.31 kg)
* Inlet pressure 91.3 psig (6.3 bar). Pressure drop 4.9 psig (0.34 bar).	

Port size	Description †	Part number
1/4"	Poly bowl - No drain	P32LB92LGNN
1/4"	Metal bowl - No drain	P32LB92LSNN
3/8"	Poly bowl - No drain	P32LB93LGNN
3/8"	Metal bowl - No drain	P32LB93LSNN
1/2"	Poly bowl - No drain	P32LB94LGNN
1/2"	Metal bowl - No drain	P32LB94LSNN

† For polycarbonate bowl, see caution in Engineering Section A.

Ordering Information:

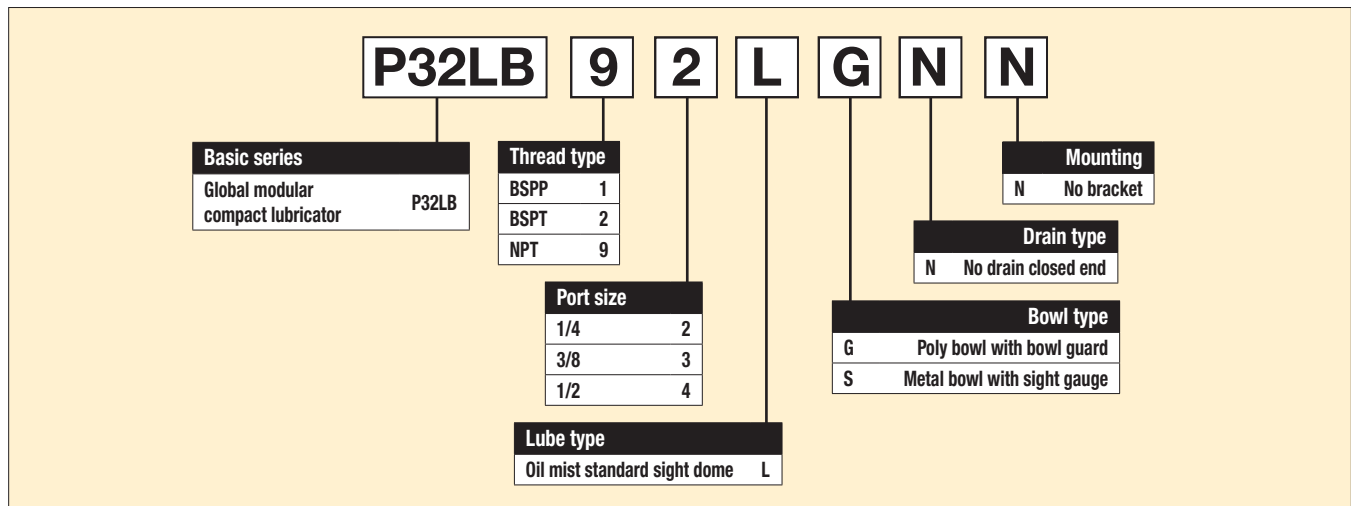

Suggested Lubricant **F442 Oil**
 Petroleum based oil of 100 to 200 SUS viscosity at 100°F (38°C) and an aniline point greater than 200°F (93°C)
 (DO NOT USE OILS WITH ADDITIVES, COMPOUNDED OILS CONTAINING SOLVENTS, GRAPHITE, DETERGENTS, OR SYNTHETIC OILS.)

Most popular.



For inventory, lead times, and kit lookup, visit www.pdnplu.com

Material Specifications

Body	Aluminum
Body cap	ABS
Plastic bowl	Polycarbonate
Metal bowl	Aluminum
Seals	Nitrile
Sight dome	Polycarbonate
Sight gauge	Nylon
Suggested lubricant	ISO / ASTM VG32
Pick-up filter	Sintered bronze

Repair and Service Kits

Plastic bowl / bowl guard no drain	P32KB00BGN
Metal bowl / w/o sight gauge no drain	P32KB00BMN
Metal bowl / Sight gauge no drain	P32KB00BSN
Drip control assembly	P32KA00PG
Fill plug	P32KA00PL
L-bracket (fits to body)	P32KA00ML
T-bracket (fits to body connector)	P32KA00MB
T-bracket with body connector	P32KA00MT
Body connector	P32KA00CB
Oil (1 quart)	F442001
Oil (1 gallon)	F442002
Oil (12 quart case)	F442003
Oil (4 gallon case)	F442005

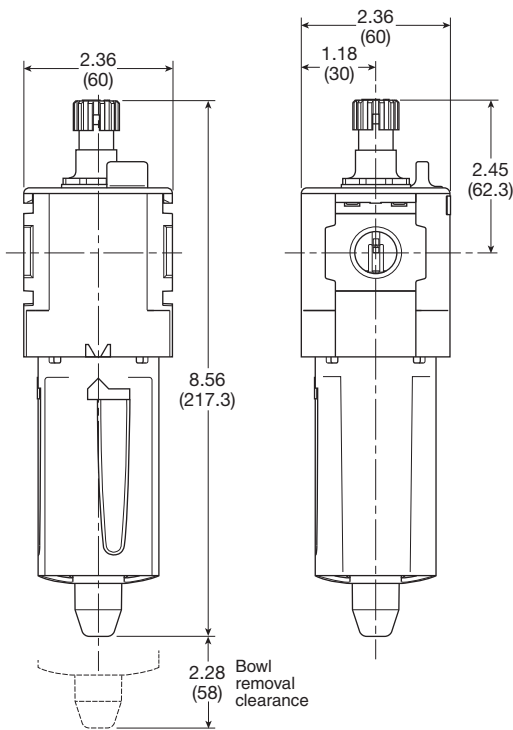

Inches (mm)

Flow Charts

P32LB 1/4" Lubricator

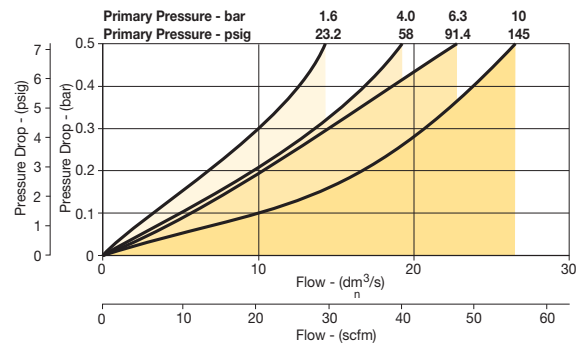

P32LB 3/8" Lubricator

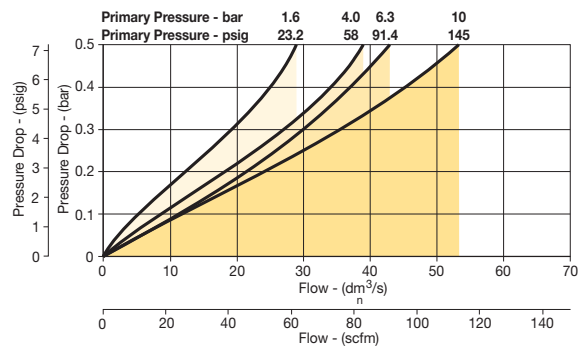

P32LB 1/2" Lubricator

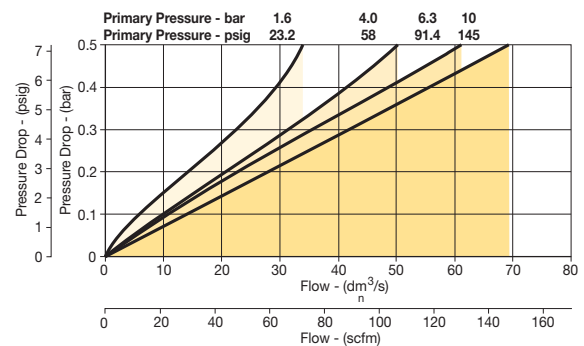

B

Global Air Preparation

Introduction

Filters

Coalescers

Regulators

Filter/Regulators

Lubricators

Combinations

Accessories and Kits



For inventory, lead time, and kit lookup, visit www.pdnplu.com

P33 Lubricators – Standard

- Integral 1/2" or 3/4" ports (NPT, BSPP & BSPT)
- Robust but lightweight aluminum construction
- Proportional oil delivery over a wide range of air flows
- Finger tip ratchet control for precise oil drip rate adjustment
- Fill from top under system pressure

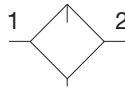

Lubricator with drain

Operating information

Flow capacity*:	
1/2	110 scfm (52 dm ³ /s, ANR)
3/4	150 scfm (71 dm ³ /s, ANR)
Operating temperature:	
Plastic bowl	14°F to 125°F (-10°C to 52°C)
Metal bowl	14°F to 150°F (-10°C to 65.5°C)
Supply pressure (max):	
Plastic bowl	150 psig (10 bar)
Metal bowl	250 psig (17 bar)
Bowl capacity:	6.1 US oz. (181 cm ³)
Weight:	1.04 lb (0.47 kg)
* Inlet pressure 91.3 psig (6.3 bar). Pressure drop 4.9 psig (0.34 bar).	

Port size	Description †	Part number
1/2"	Poly bowl - No drain	P33LA94LGNN
1/2"	Metal bowl - No drain	P33LA94LSNN
3/4"	Poly bowl - No drain	P33LA96LGNN
3/4"	Metal bowl - No drain	P33LA96LSNN

† For polycarbonate bowl, see caution in Engineering Section A.

Ordering Information:

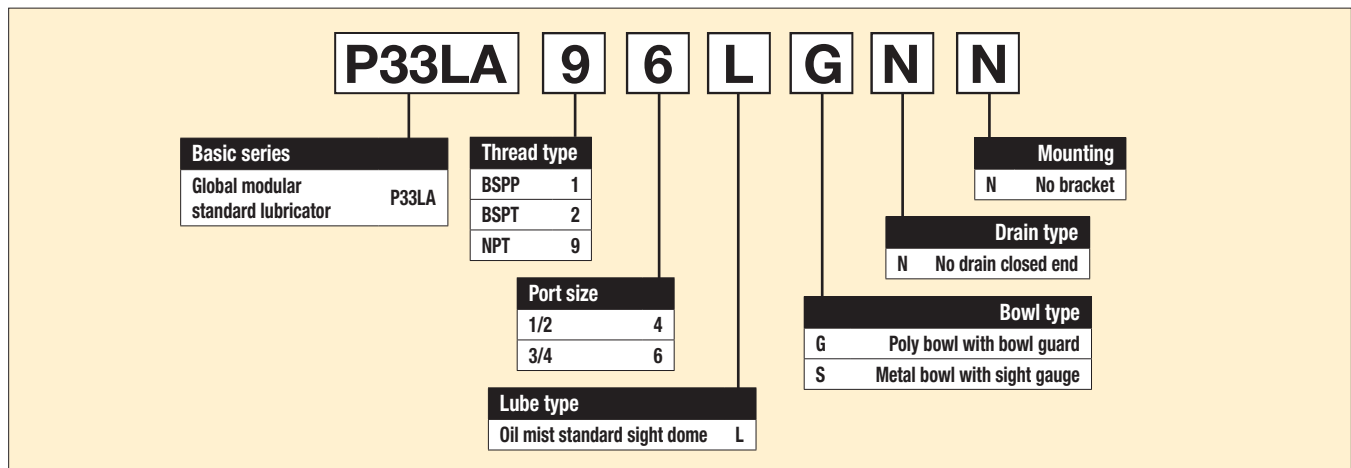

Suggested LubricantF442 Oil
 Petroleum based oil of 100 to 200 SUS viscosity at 100°F (38°C) and an aniline point greater than 200°F (93°C)
 (DO NOT USE OILS WITH ADDITIVES, COMPOUNDED OILS CONTAINING SOLVENTS, GRAPHITE, DETERGENTS, OR SYNTHETIC OILS.)

Most popular.



For inventory, lead times, and kit lookup, visit www.pdnplu.com

P Global Air Preparation
 Introduction
 Filters
 Coalescers
 Regulators
 Filter / Regulators
 Lubricators
 Combinations
 Accessories and Kits

Material Specifications

Body	Aluminum
Body cap	ABS
Plastic bowl	Polycarbonate
Metal bowl	Aluminum
Seals	Nitrile
Sight dome	Polycarbonate
Sight gauge	Nylon
Suggested lubricant	ISO / ASTM VG32
Pick-up filter	Sintered bronze

Repair and Service Kits

Plastic bowl / bowl guard no drain	P33KA00BGN
Metal bowl / w/o sight gauge no drain	P33KA00BMN
Metal bowl / sight gauge no drain	P33KA00BSN
Drip control assembly	P32KA00PG
Fill plug	P32KA00PL
L-bracket (fits to body)	P33KA00ML
T-bracket (fits to body connector)	P32KA00MB
T-bracket with body connector	P32KA00MT
Body connector	P32KA00CB
Oil (1 quart)	F442001
Oil (1 gallon)	F442002
Oil (12 quart case)	F442003
Oil (4 gallon case)	F442005

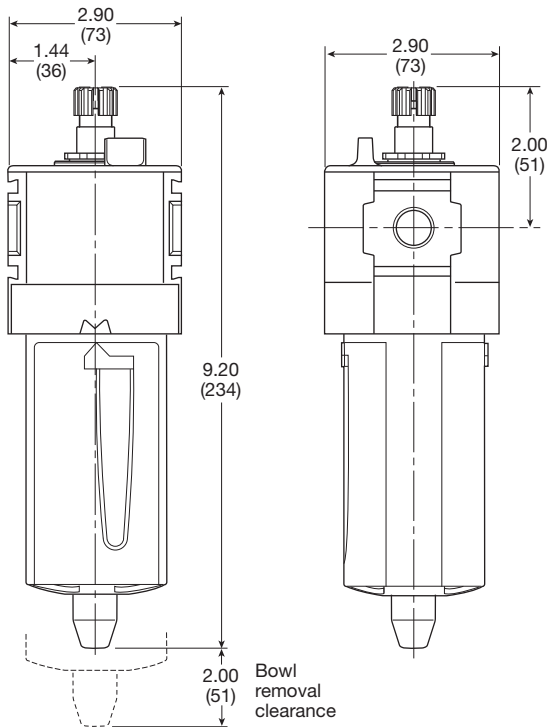

Inches (mm)

Flow Charts

P33LA 1/2" Lubricator

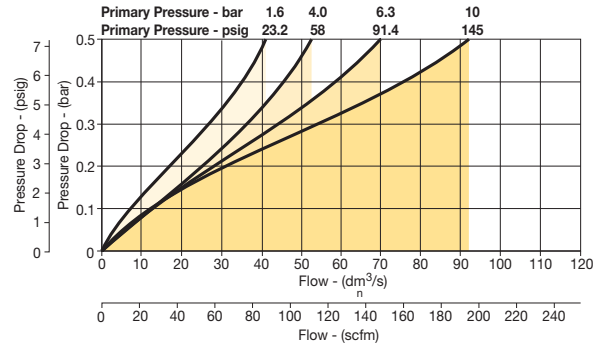

P33LA 3/4" Lubricator

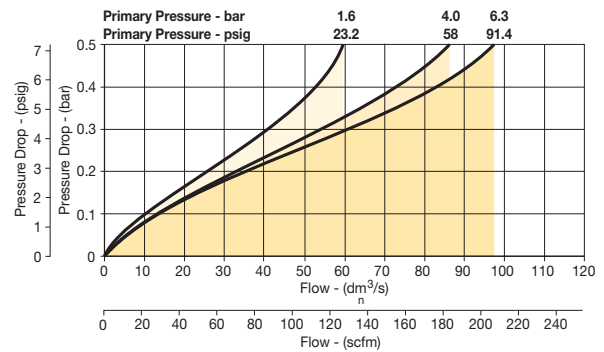

B

Global Air Preparation

Introduction

Filters

Coalescers

Regulators

Filter/Regulators

Lubricators

Combinations

Accessories and Kits



For inventory, lead time, and kit lookup, visit www.pdnplu.com

Popular Combinations: Inlet pressure 145 psig (10 bar), secondary pressure 91.3 psig (6.3 bar), 14.5 psig (1 bar) pressure drop.

B
Global Air Preparation
Introduction
Filters
Coalescers
Regulators
Filter / Regulators
Lubricators
Combinations
Accessories and Kits



**Filter + Regulator + Lubricator Combinations, poly bowl
5 micron element, 116 psig (8 bar) regulator + gauge and wall mounting brackets**

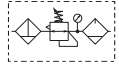

Port size	Flow	Manual drain	Pulse drain
1/4"	27 scfm (13 dm ³ /s, ANR)	P31CB92GEMN5LNW	P31CB92GEBN5LNW



**Filter/Regulator + Lubricator Combinations, poly bowl
5 micron element, 116 psig (8 bar) regulator + gauge and wall mounting brackets**

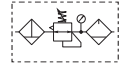

Port size	Flow	Manual drain	Pulse drain
1/4"	28 scfm (14 dm ³ /s, ANR)	P31CA92GEMN5LNW	P31CA92GEBN5LNW



**Ball Valve + Filter + Regulator + Lubricator Combinations, poly bowl
5 micron element, 116 psig (8 bar) regulator + gauge and wall mounting brackets**

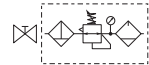

Port size	Flow	Manual drain	Pulse drain
1/4"	27 scfm (13 dm ³ /s, ANR)	P31QB92GEMN5LNW	P31QB92GEBN5LNW



**Ball Valve + Filter/Regulator + Lubricator Combinations, poly bowl
5 micron element, 116 psig (8 bar) regulator + gauge and wall mounting brackets**

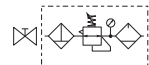

Port size	Flow	Manual drain	Pulse drain
1/4"	28 scfm (14 dm ³ /s, ANR)	P31QA92GEMN5LNW	P31QA92GEBN5LNW

Filter / Regulator coding
(use with codes: A M)

Filter coding (use with combo codes: B F G). For multiple filters, repeat as needed.	Regulator coding (use with combo code: B)	Lubricator coding (use with combo codes: A B)	Assembly configuration																													
<p>P31</p> <p>Combination B/V + Combination Q Combination + B/V X Combination C</p> <p>B/V = Ball valve</p> <p>Combination type*</p> <table border="1"> <tr> <td>F/R+L A</td> <td>F+Fc+Fa G</td> </tr> <tr> <td>F+R+L B</td> <td>F/R+Fc M</td> </tr> <tr> <td>F+Fc F</td> <td></td> </tr> </table> <p>* Combination type F = 5µ Fc1 = 1µ Fc = .01µ Fa = Adsorber</p> <p>Thread type BSPP 1 BSPT 2 NPT 9</p> <p>Port size 1/4 2</p> <p>Bowl type Poly bowl with bowl guard † G Metal bowl without sight gauge M</p> <p>Note: All bowl types are the same for each component Example: If a "G" is specified for a F+L, both units would get a poly bowl with bowl guard. † For polycarbonate bowl, see caution in Engineering Section A.</p>	F/R+L A	F+Fc+Fa G	F+R+L B	F/R+Fc M	F+Fc F		<p>E M</p> <p>Element 5µ Element E 0.01µ Element C 1µ Element 9 Adsorber A</p> <p>Drain type Manual drain M Pulse drain B</p>	<p>N 5</p> <p>Relief / Adjustment Non-rising knob N</p> <table border="1"> <thead> <tr> <th>Adjustment range</th> <th></th> </tr> </thead> <tbody> <tr> <td>With round gauge</td> <td></td> </tr> <tr> <td>30 psig; 2 bar; 0.2 MPa</td> <td>Z</td> </tr> <tr> <td>60 psig; 4 bar; 0.4 MPa</td> <td>M</td> </tr> <tr> <td>125 psig; 8 bar; 0.8 MPa</td> <td>G</td> </tr> <tr> <td>232 psig; 16 bar; 1.6 MPa</td> <td>J[§]</td> </tr> <tr> <td>Without gauge</td> <td></td> </tr> <tr> <td>30 psig; 2 bar; 0.2 MPa</td> <td>Y</td> </tr> <tr> <td>60 psig; 4 bar; 0.4 MPa</td> <td>L</td> </tr> <tr> <td>125 psig; 8 bar; 0.8 MPa</td> <td>N</td> </tr> <tr> <td>232 psig; 16 bar; 1.6 MPa</td> <td>H[§]</td> </tr> </tbody> </table>	Adjustment range		With round gauge		30 psig; 2 bar; 0.2 MPa	Z	60 psig; 4 bar; 0.4 MPa	M	125 psig; 8 bar; 0.8 MPa	G	232 psig; 16 bar; 1.6 MPa	J [§]	Without gauge		30 psig; 2 bar; 0.2 MPa	Y	60 psig; 4 bar; 0.4 MPa	L	125 psig; 8 bar; 0.8 MPa	N	232 psig; 16 bar; 1.6 MPa	H [§]	<p>L N</p> <p>Lub type Oil mist standard sight dome L</p> <p>Drain type No drain; closed end N</p>	<p>W</p> <p>Mounting No bracket A Port blocks C* Port blocks & wall brkt D* Wall bracket W</p> <p>* For 3/8" Port Blocks please order separately. See Kits section.</p> <p>* Regulator comes with gauge respective to the adjustment range selected. § Not available with poly bowl with bowl guard.</p>
F/R+L A	F+Fc+Fa G																															
F+R+L B	F/R+Fc M																															
F+Fc F																																
Adjustment range																																
With round gauge																																
30 psig; 2 bar; 0.2 MPa	Z																															
60 psig; 4 bar; 0.4 MPa	M																															
125 psig; 8 bar; 0.8 MPa	G																															
232 psig; 16 bar; 1.6 MPa	J [§]																															
Without gauge																																
30 psig; 2 bar; 0.2 MPa	Y																															
60 psig; 4 bar; 0.4 MPa	L																															
125 psig; 8 bar; 0.8 MPa	N																															
232 psig; 16 bar; 1.6 MPa	H [§]																															



For inventory, lead times, and kit lookup, visit www.pdnplu.com

Popular Combinations: Inlet pressure 145 psig (10 bar), secondary pressure 91.3 psig (6.3 bar), 14.5 psig (1 bar) pressure drop.

B
Global Air Preparation
Introduction
Filters
Coalescers
Regulators
Filter/Regulators
Lubricators
Combinations
Accessories and Kits



Filter + Regulator + Lubricator Combinations, poly bowl
5 micron element, 116 psig (8 bar) regulator + gauge and wall mounting brackets

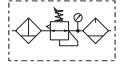

Port size	Flow	Manual drain	Auto drain
1/4"	42 scfm (20 dm ³ /s, ANR)	P32CB92GEMNGLNW	P32CB92GEANGLNW
3/8"	68 scfm (32 dm ³ /s, ANR)	P32CB93GEMNGLNW	P32CB93GEANGLNW
1/2"	85 scfm (40 dm ³ /s, ANR)	P32CB94GEMNGLNW	P32CB94GEANGLNW



Filter/Regulator + Lubricator Combinations, poly bowl
5 micron element, 116 psig (8 bar) regulator + gauge and wall mounting brackets

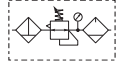

Port size	Flow	Manual drain	Auto drain
1/4"	45 scfm (22 dm ³ /s, ANR)	P32CA92GEMNGLNW	P32CA92GEANGLNW
3/8"	70 scfm (33 dm ³ /s, ANR)	P32CA93GEMNGLNW	P32CA93GEANGLNW
1/2"	90 scfm (43 dm ³ /s, ANR)	P32CA94GEMNGLNW	P32CA94GEANGLNW



Ball Valve + Filter + Regulator + Lubricator Combinations, poly bowl
5 micron element, 116 psig (8 bar) regulator + gauge and wall mounting brackets

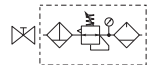

Port size	Flow	Manual drain	Auto drain
1/4"	42 scfm (20 dm ³ /s, ANR)	P32QB92GEMNGLNW	P32QB92GEANGLNW
3/8"	68 scfm (32 dm ³ /s, ANR)	P32QB93GEMNGLNW	P32QB93GEANGLNW
1/2"	85 scfm (40 dm ³ /s, ANR)	P32QB94GEMNGLNW	P32QB94GEANGLNW



Ball Valve + Filter/Regulator + Lubricator Combinations, poly bowl
5 micron element, 116 psig (8 bar) regulator + gauge and wall mounting brackets

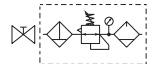

Port size	Flow	Manual drain	Auto drain
1/4"	45 scfm (22 dm ³ /s, ANR)	P32QA92GEMNGLNW	P32QA92GEANGLNW
3/8"	70 scfm (33 dm ³ /s, ANR)	P32QA93GEMNGLNW	P32QA93GEANGLNW
1/2"	90 scfm (43 dm ³ /s, ANR)	P32QA94GEMNGLNW	P32QA94GEANGLNW

Filter / Regulator coding
(use with codes: A M)

Filter coding (use with combo codes: B F G, For multiple filters, repeat as needed.	Regulator coding (use with combo code: B)	Lubricator coding (use with combo codes: A B)	Assembly configuration
--	--	---	---------------------------

<p>P32</p> <p>Combination</p> <table border="1"> <tr><td>B/V + Combination</td><td>Q</td></tr> <tr><td>Combination + B/V</td><td>X</td></tr> <tr><td>Combination</td><td>C</td></tr> </table> <p>B/V = Ball valve</p> <p>Combination type*</p> <table border="1"> <tr><td>F/R+L</td><td>A</td><td>F+Fc+Fa</td><td>G</td></tr> <tr><td>F+R+L</td><td>B</td><td>F/R+Fc</td><td>M</td></tr> <tr><td>F+Fc</td><td>F</td><td></td><td></td></tr> </table> <p>* Combination type F = 5μ Fc = 1μ Fa = Adsorber</p> <p>† For polycarbonate bowl, see caution in Engineering Section A.</p> <p>Bowl type</p> <table border="1"> <tr><td>Poly bowl with bowl guard ‡</td><td>G</td></tr> <tr><td>Metal bowl without sight gauge</td><td>M*</td></tr> <tr><td>Metal bowl with sight gauge</td><td>S</td></tr> </table> <p>* Not available when using Lubricator. Note: All bowl types are the same for each component. Example: If a "G" is specified for a F+L, both units would get a poly bowl with bowl guard.</p>	B/V + Combination	Q	Combination + B/V	X	Combination	C	F/R+L	A	F+Fc+Fa	G	F+R+L	B	F/R+Fc	M	F+Fc	F			Poly bowl with bowl guard ‡	G	Metal bowl without sight gauge	M*	Metal bowl with sight gauge	S	<p>C</p> <p>Thread type</p> <table border="1"> <tr><td>BSPP</td><td>1</td></tr> <tr><td>BSPT</td><td>2</td></tr> <tr><td>NPT</td><td>9</td></tr> </table> <p>Port size</p> <table border="1"> <tr><td>1/4</td><td>2*</td></tr> <tr><td>3/8</td><td>3</td></tr> <tr><td>1/2</td><td>4</td></tr> </table> <p>* Order combo Q or X: ball valve (BV) comes with 3/8 ports.</p> <p>Element</p> <table border="1"> <tr><td>0.01μ Element</td><td>C</td></tr> <tr><td>0.01μ Element with dpi</td><td>D*</td></tr> <tr><td>5μ Element</td><td>E</td></tr> <tr><td>5μ Element with dpi</td><td>F*</td></tr> <tr><td>1μ Element</td><td>9</td></tr> <tr><td>1μ Element with dpi</td><td>Q*</td></tr> <tr><td>Adsorber</td><td>A</td></tr> </table> <p>* Not available with F/R.</p> <p>Drain type</p> <table border="1"> <tr><td>Auto drain</td><td>A</td></tr> <tr><td>Manual drain</td><td>M</td></tr> </table>	BSPP	1	BSPT	2	NPT	9	1/4	2*	3/8	3	1/2	4	0.01μ Element	C	0.01μ Element with dpi	D*	5μ Element	E	5μ Element with dpi	F*	1μ Element	9	1μ Element with dpi	Q*	Adsorber	A	Auto drain	A	Manual drain	M	<p>E M</p> <p>Relief / Adjustment</p> <table border="1"> <tr><td>Non-rising knob relieving</td><td>N</td></tr> </table> <p>Adjustment range</p> <table border="1"> <tr><td colspan="2">With round gauge</td></tr> <tr><td>30 psig; 2 bar; 0.2 MPa</td><td>Z</td></tr> <tr><td>60 psig; 4 bar; 0.4 MPa</td><td>M</td></tr> <tr><td>125 psig; 8 bar; 0.8 MPa</td><td>G</td></tr> <tr><td>250 psig; 17 bar; 1.7 MPa</td><td>J[§]</td></tr> <tr><td colspan="2">Without gauge</td></tr> <tr><td>30 psig; 2 bar; 0.2 MPa</td><td>Y</td></tr> <tr><td>60 psig; 4 bar; 0.4 MPa</td><td>L</td></tr> <tr><td>125 psig; 8 bar; 0.8 MPa</td><td>N</td></tr> <tr><td>250 psig; 17 bar; 1.7 MPa</td><td>H[§]</td></tr> </table> <p>With square gauge</p> <table border="1"> <tr><td>30*</td><td>=</td><td>1</td><td>2*</td><td>=</td><td>V</td></tr> <tr><td>60</td><td>=</td><td>3</td><td>4</td><td>=</td><td>S</td></tr> <tr><td>125</td><td>=</td><td>5</td><td>8</td><td>=</td><td>T</td></tr> </table>	Non-rising knob relieving	N	With round gauge		30 psig; 2 bar; 0.2 MPa	Z	60 psig; 4 bar; 0.4 MPa	M	125 psig; 8 bar; 0.8 MPa	G	250 psig; 17 bar; 1.7 MPa	J[§]	Without gauge		30 psig; 2 bar; 0.2 MPa	Y	60 psig; 4 bar; 0.4 MPa	L	125 psig; 8 bar; 0.8 MPa	N	250 psig; 17 bar; 1.7 MPa	H[§]	30*	=	1	2*	=	V	60	=	3	4	=	S	125	=	5	8	=	T	<p>N G</p> <p>Lub type</p> <table border="1"> <tr><td>Oil mist standard sight dome</td><td>L</td></tr> </table> <p>Drain type</p> <table border="1"> <tr><td>No drain; closed end</td><td>N</td></tr> </table> <p>Mounting</p> <table border="1"> <tr><td>No bracket</td><td>A</td></tr> <tr><td>Port blocks</td><td>C</td></tr> <tr><td>Port blocks & wall brkt</td><td>D</td></tr> <tr><td>Wall bracket</td><td>W</td></tr> </table> <p>* Regulator comes with gauge respective to the adjustment range selected. [§] Not available with poly bowl with bowl guard.</p>	Oil mist standard sight dome	L	No drain; closed end	N	No bracket	A	Port blocks	C	Port blocks & wall brkt	D	Wall bracket	W
B/V + Combination	Q																																																																																																												
Combination + B/V	X																																																																																																												
Combination	C																																																																																																												
F/R+L	A	F+Fc+Fa	G																																																																																																										
F+R+L	B	F/R+Fc	M																																																																																																										
F+Fc	F																																																																																																												
Poly bowl with bowl guard ‡	G																																																																																																												
Metal bowl without sight gauge	M*																																																																																																												
Metal bowl with sight gauge	S																																																																																																												
BSPP	1																																																																																																												
BSPT	2																																																																																																												
NPT	9																																																																																																												
1/4	2*																																																																																																												
3/8	3																																																																																																												
1/2	4																																																																																																												
0.01μ Element	C																																																																																																												
0.01μ Element with dpi	D*																																																																																																												
5μ Element	E																																																																																																												
5μ Element with dpi	F*																																																																																																												
1μ Element	9																																																																																																												
1μ Element with dpi	Q*																																																																																																												
Adsorber	A																																																																																																												
Auto drain	A																																																																																																												
Manual drain	M																																																																																																												
Non-rising knob relieving	N																																																																																																												
With round gauge																																																																																																													
30 psig; 2 bar; 0.2 MPa	Z																																																																																																												
60 psig; 4 bar; 0.4 MPa	M																																																																																																												
125 psig; 8 bar; 0.8 MPa	G																																																																																																												
250 psig; 17 bar; 1.7 MPa	J[§]																																																																																																												
Without gauge																																																																																																													
30 psig; 2 bar; 0.2 MPa	Y																																																																																																												
60 psig; 4 bar; 0.4 MPa	L																																																																																																												
125 psig; 8 bar; 0.8 MPa	N																																																																																																												
250 psig; 17 bar; 1.7 MPa	H[§]																																																																																																												
30*	=	1	2*	=	V																																																																																																								
60	=	3	4	=	S																																																																																																								
125	=	5	8	=	T																																																																																																								
Oil mist standard sight dome	L																																																																																																												
No drain; closed end	N																																																																																																												
No bracket	A																																																																																																												
Port blocks	C																																																																																																												
Port blocks & wall brkt	D																																																																																																												
Wall bracket	W																																																																																																												



For inventory, lead time, and kit lookup, visit www.pdnplu.com

Popular Combinations: Inlet pressure 145 psig (10 bar), secondary pressure 91.3 psig (6.3 bar), 14.5 psig (1 bar) pressure drop.

B
Global Air Preparation
Introduction
Filters
Coalescers
Regulators
Filter / Regulators
Lubricators
Combinations
Accessories and Kits



Filter + Regulator + Lubricator Combinations, poly bowl
5 micron element, 116 psig (8 bar) regulator + gauge and wall mounting brackets

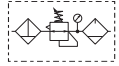

Port size	Flow	Manual drain	Auto drain
1/2"	90 scfm (43 dm³/s, ANR)	P33CB94GEMNGLNW	P33CB94GEANGLNW
3/4"	110 scfm (52 dm³/s, ANR)	P33CB96GEMNGLNW	P33CB96GEANGLNW



Filter/Regulator + Lubricator Combinations, poly bowl
5 micron element, 116 psig (8 bar) regulator + gauge and wall mounting brackets

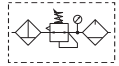

Port size	Flow	Manual drain	Auto drain
1/2"	110 scfm (52 dm³/s, ANR)	P33CA94GEMNGLNW	P33CA94GEANGLNW
3/4"	150 scfm (71 dm³/s, ANR)	P33CA96GEMNGLNW	P33CA96GEANGLNW



Ball Valve + Filter + Regulator + Lubricator Combinations, poly bowl
5 micron element, 116 psig (8 bar) regulator + gauge and wall mounting brackets

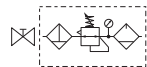

Port size	Flow	Manual drain	Auto drain
1/2"	90 scfm (43 dm³/s, ANR)	P33QB94GEMNGLNW	P33QB94GEANGLNW
3/4"	110 scfm (52 dm³/s, ANR)	P33QB96GEMNGLNW	P33QB96GEANGLNW



Ball Valve + Filter/Regulator + Lubricator Combinations, poly bowl
5 micron element, 116 psig (8 bar) regulator + gauge and wall mounting brackets

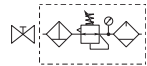

Port size	Flow	Manual drain	Auto drain
1/2"	110 scfm (52 dm³/s, ANR)	P33QA94GEMNGLNW	P33QA94GEANGLNW
3/4"	150 scfm (71 dm³/s, ANR)	P33QA96GEMNGLNW	P33QA96GEANGLNW

Filter / Regulator coding
(use with codes: A M)

Filter coding (use with combo codes: B F G). For multiple filters, repeat as needed.	Regulator coding (use with combo code: B)	Lubricator coding (use with combo codes: A B)	Assembly configuration
---	--	--	------------------------

<p>P33</p> <p>Combination</p> <p>B/V + Combination Q</p> <p>Combination + B/V X</p> <p>Combination C</p> <p>B/V = Ball valve</p> <p>Combination type*</p> <table border="1"> <tr> <td>F/R+L A</td> <td>F+Fc+Fa G</td> </tr> <tr> <td>F+R+L B</td> <td>F/R+Fc M</td> </tr> <tr> <td>F+Fc F</td> <td></td> </tr> </table> <p>* Combination type</p> <p>F = 5µ Fc = 1µ Fc = .01µ Fa = Adsorber</p> <p>Bowl type †</p> <table border="1"> <tr> <td>Poly bowl with bowl guard G</td> </tr> <tr> <td>Metal bowl without sight gauge M*</td> </tr> <tr> <td>Metal bowl with sight gauge S</td> </tr> </table> <p>† Not available when using lubricator. Note: All bowl types are the same for each component. Example: If a "G" is specified for a F+L, both units would get a poly bowl with bowl guard.</p>	F/R+L A	F+Fc+Fa G	F+R+L B	F/R+Fc M	F+Fc F		Poly bowl with bowl guard G	Metal bowl without sight gauge M*	Metal bowl with sight gauge S	<p>C</p> <p>Thread type</p> <table border="1"> <tr> <td>BSPP 1</td> </tr> <tr> <td>BSPT 2</td> </tr> <tr> <td>NPT 9</td> </tr> </table> <p>Port size</p> <table border="1"> <tr> <td>1/2 4</td> </tr> <tr> <td>3/4 6</td> </tr> </table>	BSPP 1	BSPT 2	NPT 9	1/2 4	3/4 6	<p>9 6 G</p> <p>Element</p> <table border="1"> <tr> <td>0.01µ Element C</td> </tr> <tr> <td>0.01µ Element with dpi D*</td> </tr> <tr> <td>5µ Element E</td> </tr> <tr> <td>5µ Element with dpi F*</td> </tr> <tr> <td>1µ Element 9</td> </tr> <tr> <td>1µ Element with dpi Q*</td> </tr> <tr> <td>Adsorber A</td> </tr> </table> <p>* Not available with F/R.</p> <p>Drain type</p> <table border="1"> <tr> <td>Auto drain A</td> </tr> <tr> <td>Manual drain M</td> </tr> </table>	0.01µ Element C	0.01µ Element with dpi D*	5µ Element E	5µ Element with dpi F*	1µ Element 9	1µ Element with dpi Q*	Adsorber A	Auto drain A	Manual drain M	<p>E M</p> <p>Relief / Adjustment</p> <table border="1"> <tr> <td>Non-rising knob relieving N</td> </tr> </table> <p>Adjustment range</p> <table border="1"> <tr> <td>With round gauge</td> </tr> <tr> <td>30 psig; 2 bar; 0.2 MPa Z</td> </tr> <tr> <td>60 psig; 4 bar; 0.4 MPa M</td> </tr> <tr> <td>125 psig; 8 bar; 0.8 MPa G</td> </tr> <tr> <td>250 psig; 17 bar; 1.7 MPa J*</td> </tr> <tr> <td>Without gauge</td> </tr> <tr> <td>30 psig; 2 bar; 0.2 MPa Y</td> </tr> <tr> <td>60 psig; 4 bar; 0.4 MPa L</td> </tr> <tr> <td>125 psig; 8 bar; 0.8 MPa N</td> </tr> <tr> <td>250 psig; 17 bar; 1.7 MPa H*</td> </tr> </table> <p>* Not available with poly bowl with bowl guard.</p>	Non-rising knob relieving N	With round gauge	30 psig; 2 bar; 0.2 MPa Z	60 psig; 4 bar; 0.4 MPa M	125 psig; 8 bar; 0.8 MPa G	250 psig; 17 bar; 1.7 MPa J*	Without gauge	30 psig; 2 bar; 0.2 MPa Y	60 psig; 4 bar; 0.4 MPa L	125 psig; 8 bar; 0.8 MPa N	250 psig; 17 bar; 1.7 MPa H*	<p>N G</p> <p>Lub type</p> <table border="1"> <tr> <td>Oil mist standard sight dome L</td> </tr> </table> <p>Drain type</p> <table border="1"> <tr> <td>No drain; closed end N</td> </tr> </table>	Oil mist standard sight dome L	No drain; closed end N	<p>L N</p> <p>Mounting</p> <table border="1"> <tr> <td>No bracket A</td> </tr> <tr> <td>Port blocks C</td> </tr> <tr> <td>Port blocks & wall brkt D</td> </tr> <tr> <td>Wall bracket W</td> </tr> </table>	No bracket A	Port blocks C	Port blocks & wall brkt D	Wall bracket W	<p>W</p>
F/R+L A	F+Fc+Fa G																																													
F+R+L B	F/R+Fc M																																													
F+Fc F																																														
Poly bowl with bowl guard G																																														
Metal bowl without sight gauge M*																																														
Metal bowl with sight gauge S																																														
BSPP 1																																														
BSPT 2																																														
NPT 9																																														
1/2 4																																														
3/4 6																																														
0.01µ Element C																																														
0.01µ Element with dpi D*																																														
5µ Element E																																														
5µ Element with dpi F*																																														
1µ Element 9																																														
1µ Element with dpi Q*																																														
Adsorber A																																														
Auto drain A																																														
Manual drain M																																														
Non-rising knob relieving N																																														
With round gauge																																														
30 psig; 2 bar; 0.2 MPa Z																																														
60 psig; 4 bar; 0.4 MPa M																																														
125 psig; 8 bar; 0.8 MPa G																																														
250 psig; 17 bar; 1.7 MPa J*																																														
Without gauge																																														
30 psig; 2 bar; 0.2 MPa Y																																														
60 psig; 4 bar; 0.4 MPa L																																														
125 psig; 8 bar; 0.8 MPa N																																														
250 psig; 17 bar; 1.7 MPa H*																																														
Oil mist standard sight dome L																																														
No drain; closed end N																																														
No bracket A																																														
Port blocks C																																														
Port blocks & wall brkt D																																														
Wall bracket W																																														



For inventory, lead times, and kit lookup, visit www.pdnplu.com

Popular Combination Dimensions

inches (mm)

P31C

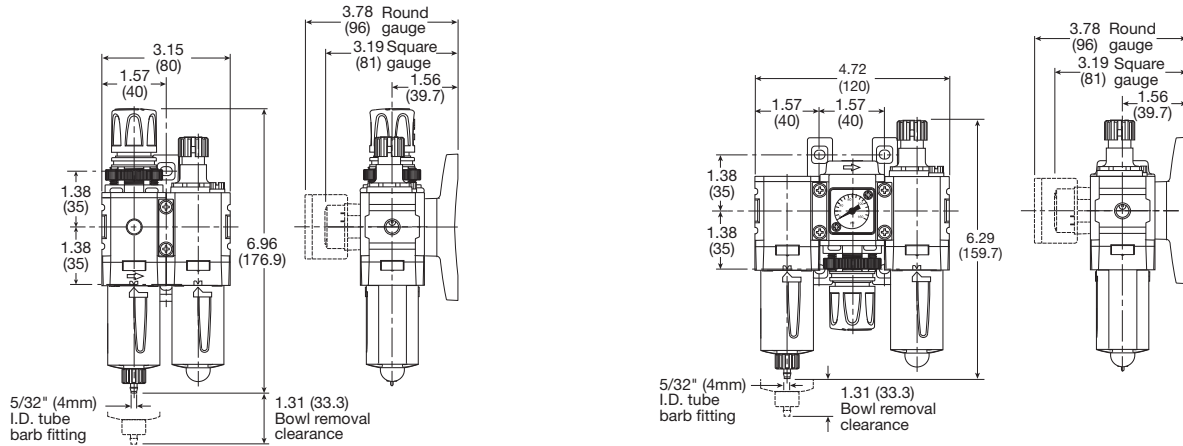

P32C

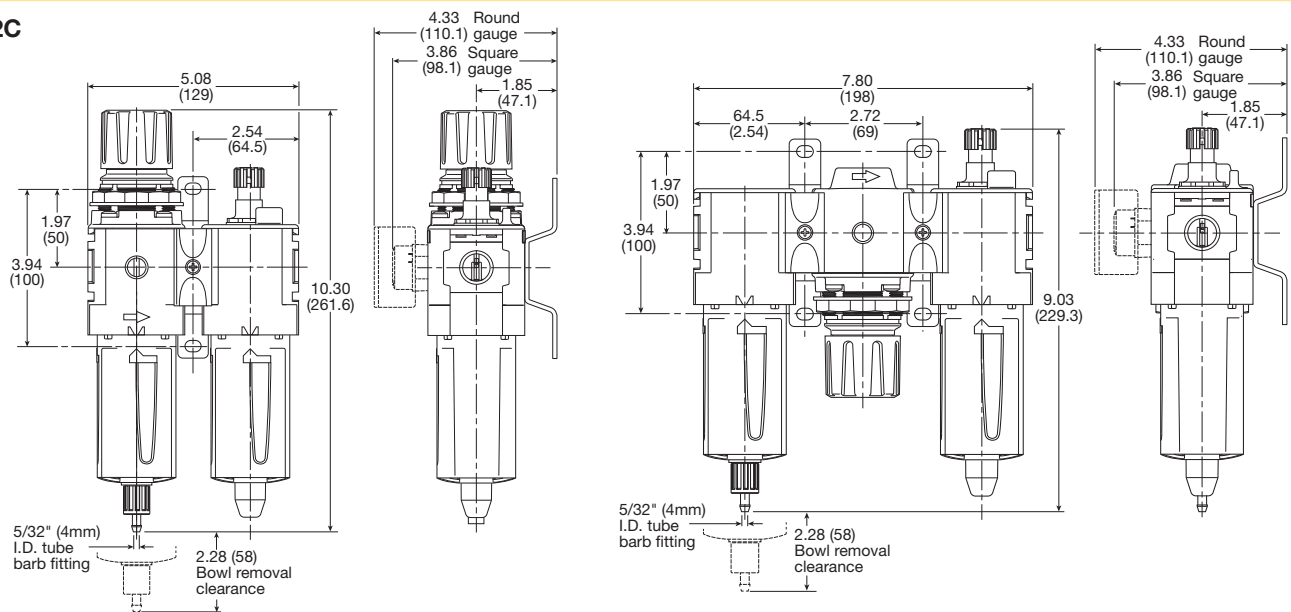

P33C

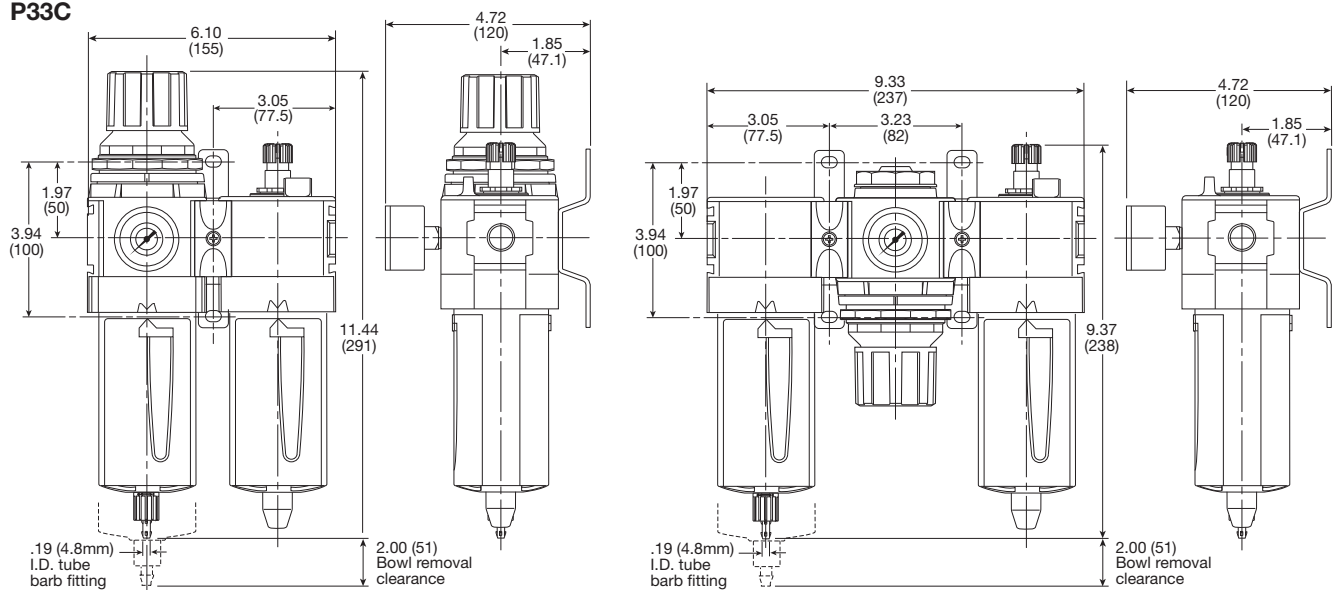

B
Global Air Preparation
Introduction
Filters
Coalescers
Regulators
Filter/Regulators
Lubricators
Combinations
Accessories and Kits



For inventory, lead time, and kit lookup, visit www.pdnplu.com

B59

Parker Hannifin Corporation
Pneumatic Division
Richland, Michigan
www.parker.com/pneumatics

P31D & P32D Dump Valves

- Modular design with 1/4" or 1/2" integral ports (NPT, BSPP & BSPT)
- The 3-way, 2-position function automatically dumps downstream pressure on the loss of pilot signal
- Solenoid or air pilot options
- High flow & exhaust capability
- Silencer included

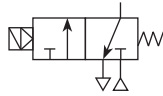

Remotely operated dump valves automatically shut off upstream pressure and exhaust the downstream pressure when the pilot pressure is released.

To maintain these units in the open position a pilot supply to the air pilot operated version or an electrical signal to the solenoid operated version must be maintained.

The valve will automatically dump when the holding signal is removed.

Port size	Description	Weight lbs (kg)	Part number
1/4"	120VAC Solenoid & cable plug	0.8 (0.37)	P31DA92SGNC1FN
1/4"	24VDC Solenoid & cable plug †	0.9 (0.41)	P31DA92SGNC2CN
1/4"	External air pilot operated	0.8 (0.37)	P31DA92PPN
1/2"	120VAC 30mm coil & cable plug incl. †	1.5 (0.69)	P32DA94SCNA3GN
1/2"	24VDC 30mm coil & cable plug incl. †	2.0 (0.91)	P32DA94SCNA2CN
1/2"	External air pilot operated †	1.9 (0.87)	P32DA94PPN

† Includes exhaust silencer

Operating information

Flow capacity*:	P31D	36 scfm (17 dm ³ /s, ANR)
	P32D	108 scfm (51 dm ³ /s, ANR)
Temperature range (max)†:	Solenoid operated	14°F to 122°F (-10°C to 50°C)
	Air pilot operated	-4°F to 176°F (-20°C to 80°C)
	Pressure (max):	
	Solenoid operated	150 psig (10 bar)
	Air pilot operated	250 psig (17 bar)
Operating pressure (min):		44 psig (3 bar)
Fluid:		Compressed air
Ports:	Air pilot	1/8
	Exhaust	P31D - 1/4; P32D - 1/2
	Gauge	P31D - 1/8; P32D - 1/4

* Inlet pressure 91.3 psig (6.3 bar), inlet pressure and 14.5 psig (1 bar) pressure drop.

† Air supply must be dry enough to avoid ice formation at temperatures below 35.6°F (2°C). Snap pressure: Full flow when downstream pressure reaches 50% of the inlet pressure.

Ordering Information:

P31DA
9
2
S
G
N

Body size

Dump valve (1/4")	P31DA
Dump valve (1/2")	P32DA

Thread type

BSPP	1
BSPT	2
NPT	9

Port size

Global modular mini (1/4")	2
Global modular compact (1/2")	4

Actuator interface

G	15mm solenoid (P31 only)
C	30mm solenoid
P	Threaded air pilot

Pilot type

P	External air pilot
S	Solenoid pilot

Solenoid type only

C
2CN

Solenoid voltage

2CN	24VDC non locking manual override
3GN	120VAC non locking manual override
1FN	120VAC non locking manual override (P31 series only)

Solenoid type

C	15mm (P31 series only)
A	30mm CNOMO coil (P32 only)
D	30mm CNOMO coil (M12 connection) (P32 only)

Note: P32 unit used for both P32 & P33 series

☐ Most popular.



For inventory, lead times, and kit lookup, visit www.pdnplu.com

B60

Parker Hannifin Corporation
 Pneumatic Division
 Richland, Michigan
www.parker.com/pneumatics

Dump Valves

Material Specifications

Body	Aluminum
Body cover	Polyester
Seals	Nitrile NBR

Mounting Brackets

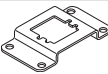
	Description	Part number
	L-bracket mounting kit	P31D
P31		P3HKA00ML
	Foot bracket mounting kit	P3HKA00MC
P31		P3HKA00MC

Note:

For solenoid operators and cable plugs (connectors) see page B79 and B80.

Air Preparation Products

Global Air Preparation

Flow Charts

P31DA 1/4" Remote Dump Valve

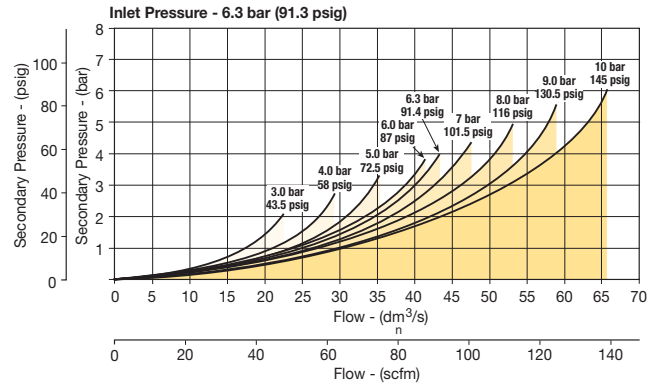

P32DA 1/2" Remote Dump Valve

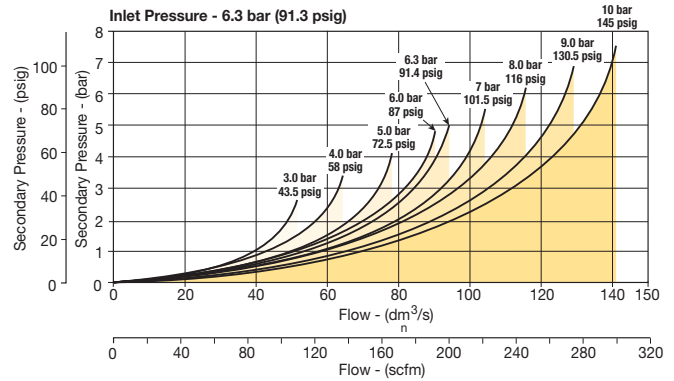

Dimensions inches (mm)

P31D

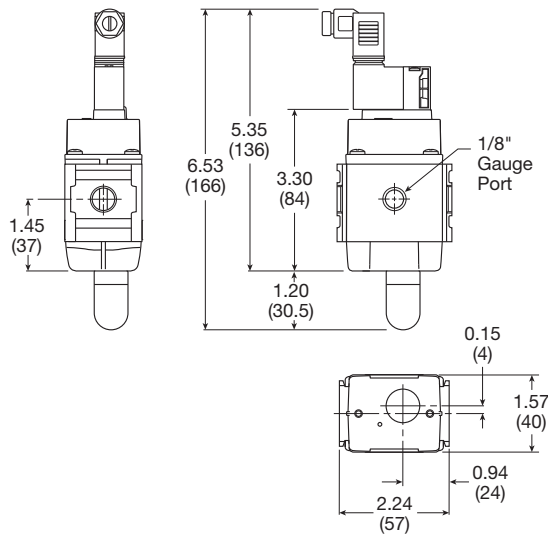

P32D

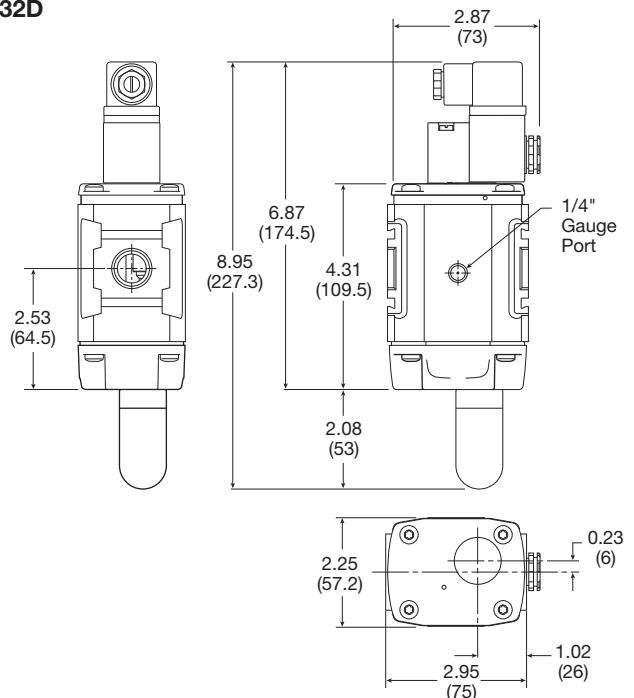

 Most popular.



For inventory, lead time, and kit lookup, visit www.pdnplu.com

B61

Parker Hannifin Corporation
 Pneumatic Division
 Richland, Michigan
www.parker.com/pneumatics

P31S & P32S Soft Start Valves

- Modular design with 1/4" or 1/2" integral ports (NPT, BSPP & BSPT)
- The 2-way, 2-position function provides for the safe introduction of pressure
- Adjustable slow start
- Solenoid or air pilot options
- High flow

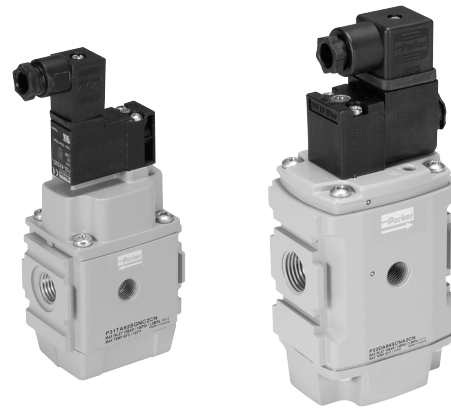
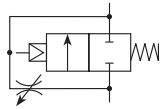

Parker Global Series Soft Start Valves, provide for the safe introduction of pressure to machines or systems. Soft Start Valves, allow the pressure to gradually build to the set point before fully opening to deliver full flow at line pressure.

The controlled introduction of pressure can be an important safety factor and prevent damage to tooling when air pressure is introduced at machine or system start up.

Note: Soft Start Valves must be installed downstream of a 3/2 valve with exhaust capability

Port size	Description	Weight lbs (kg)	Part number
1/4"	120VAC Solenoid & cable plug	0.8 (0.37)	P31SA92SGNC1FN
1/4"	24VDC Solenoid & cable plug	0.9 (0.41)	P31SA92SGNC2CN
1/4"	Internal air pilot operated	0.8 (0.37)	P31SA92Y0N
1/4"	External air pilot (1/8" threaded)	0.8 (0.37)	P31SA92PPN
1/2"	120VAC 30mm coil & cable plug incl.	1.5 (0.87)	P32SA94SCNA3GN
1/2"	24VDC 30mm coil & cable plug	2.0 (0.90)	P32SA94SCNA2CN
1/2"	Internal air pilot operated	2.0 (0.90)	P32SA94Y0N
1/2"	External air pilot (1/8 threaded)	1.5 (0.87)	P32SA94PPN

Operating information

Flow capacity*:	P31S	36 scfm (17 dm ³ /s, ANR)
	P32S	101 scfm (48 dm ³ /s, ANR)
Temperature range (max)†:		
Solenoid operated		14°F to 122°F (-10°C to 50°C)
Air pilot operated		-4°F to 176°F (-20°C to 80°C)
Pressure (max):		
Solenoid operated		150 psig (10 bar)
Air pilot operated		250 psig (7 bar)
Operating pressure (min):		44 psig (3 bar)
Fluid:		Compressed air
Ports:	Air pilot	1/8
	Gauge	P31S - 1/8; P32S - 1/4

* Inlet pressure 91.3 psig (6.3 bar), inlet pressure and 14.5 psig (1 bar) pressure drop.

† Air supply must be dry enough to avoid ice formation at temperatures below 35.6°F (2°C). Snap pressure: Full flow when downstream pressure reaches 50% of the inlet pressure.

Ordering Information:

P31SA
9
2
S
G
N

Body size

Soft start	P31SA
Soft start	P32SA

Thread type

BSPP	1
BSPT	2
NPT	9

Actuator interface

O	Internal pilot
G	15mm solenoid (P31 only)
C	30mm solenoid
P	Threaded air pilot

Solenoid voltage

2CN	24VDC non locking manual override
3GN	120VAC non locking manual override
1FN	120VAC non locking manual override (P31 series only)

Port size

Global modular mini (1/4")	2
Global modular compact (1/2")	4

Pilot type

P	External air pilot
S	Solenoid pilot
Y	Internal air pilot

Solenoid type

C	15mm (P31 series only)
A	30mm CNOMO coil (P32 only)
D	30mm CNOMO coil (M12 connection) (P32 only)

Note: P32 unit used for both P32 & P33 series

Most popular.



For inventory, lead times, and kit lookup, visit www.pdnplu.com



B62

Parker Hannifin Corporation
 Pneumatic Division
 Richland, Michigan
www.parker.com/pneumatics

Material Specifications

Body	Aluminum
Body cover	Polyester
Seals	Nitrile NBR

Mounting Brackets

	Description	Part number
		P31S
	L-bracket mounting kit	P3HKA00ML
	Foot bracket mounting kit	P3HKA00MC

Note:

For solenoid operators and cable plugs (connectors) see page B79 and B80.

Flow Charts

P31SA 1/4" Soft Start Valve

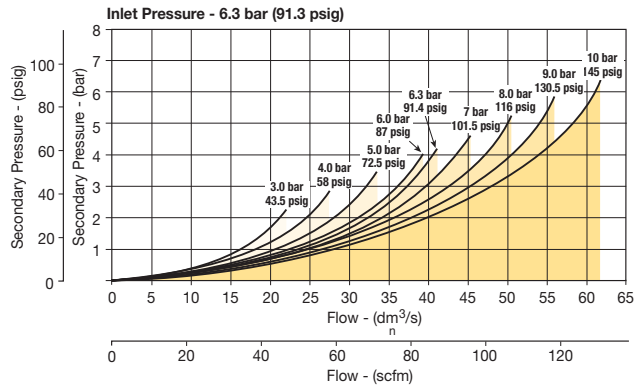

P32SA 1/2" Soft Start Valve

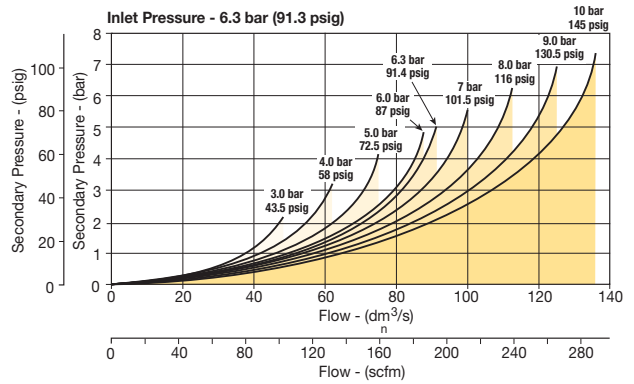

Dimensions inches (mm)

P31S

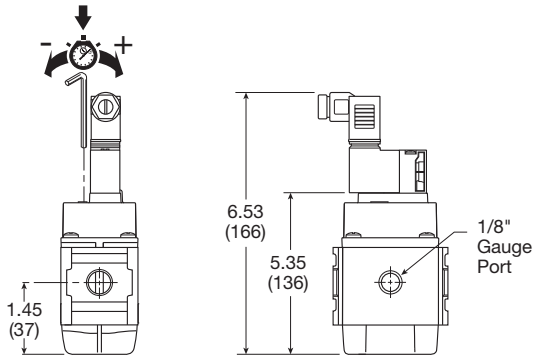

P32S

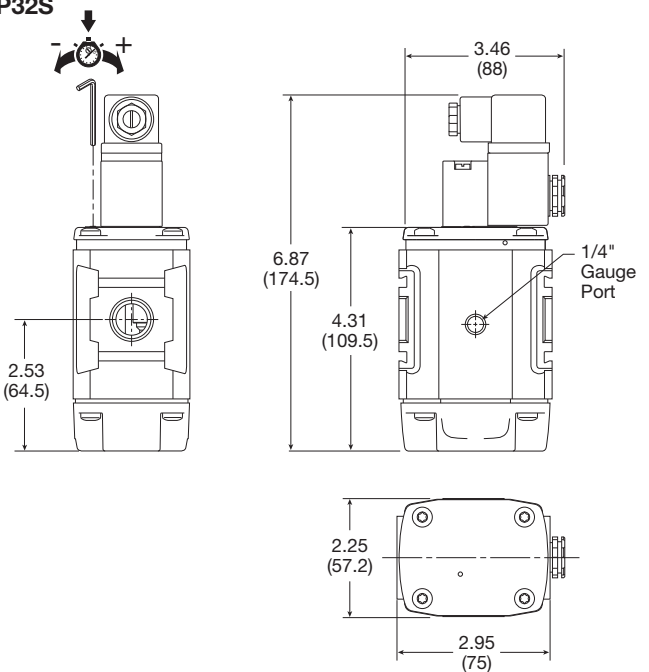

Soft Start Function:

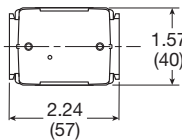
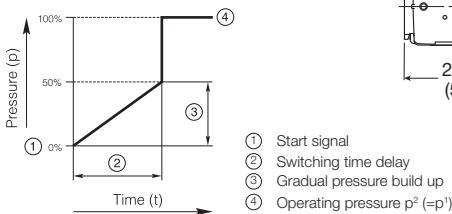

- ① Start signal
- ② Switching time delay
- ③ Gradual pressure build up
- ④ Operating pressure $p^2 (=p')$



For inventory, lead time, and kit lookup, visit www.pdnplu.com

P31T & P32T Combined Soft Start / Dump Valves

- Modular design with 1/4" or 1/2" integral ports (NPT, BSPP & BSPT)
- Provides for the safe introduction of pressure
- The 3-way, 2-position function automatically dumps downstream pressure on the loss of pilot signal
- Adjustable slow start
- Solenoid or air pilot options
- High flow & exhaust capability
- Silencer included

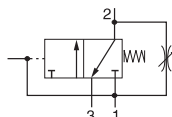

Parker Global Series Combined Soft Start / Dump Valves, provide for the safe introduction of pressure to machines or systems. Soft Start / Dump Valves when set, allow the pressure to gradually build to the set point before fully opening to deliver full flow at line pressure.

The controlled introduction of pressure can be an important safety factor and prevent damage to tooling when air pressure is introduced at machine or system start up.

To maintain these units in the open position a pilot supply to the air pilot operated version or an electrical signal to the solenoid operated version must be maintained. The valve will automatically dump when the holding signal is removed.

Port size	Description	Weight lbs (kg)	Part number
1/4"	120VAC Solenoid & cable plug	0.8 (0.37)	P31TA92SGNC1FN
1/4"	24VDC Solenoid & cable plug	0.9 (0.41)	P31TA92SGNC2CN
1/4"	External air pilot operated	0.8 (0.37)	P31TA92PPN
1/2"	120VAC 30mm coil & cable plug incl.	1.9 (0.87)	P32TA94SCNA3GN
1/2"	24VDC 30mm coil & cable plug incl.	2.0 (0.91)	P32TA94SCNA2CN
1/2"	External air pilot operated	1.9 (0.87)	P32TA94PPN

Operating information

Flow capacity*:	P31T	36 scfm (17 dm ³ /s, ANR)
	P32T	108 scfm (51 dm ³ /s, ANR)
Temperature range (max)†:		
Solenoid operated		14°F to 122°F (-10°C to 50°C)
Air pilot operated		-4°F to 176°F (-20°C to 80°C)
Pressure (max):		
Solenoid operated		150 psig (10 bar)
Air pilot operated		250 psig (7 bar)
Operating pressure (min):		44 psig (3 bar)
Fluid:		Compressed air
Ports:	Air pilot	1/8
	Exhaust	P31T - 1/4; P32T - 1/2
	Gauge	P31T - 1/8; P32T - 1/4

* Inlet pressure 91.3 psig (6.3 bar), inlet pressure and 14.5 psig (1 bar) pressure drop.

† Air supply must be dry enough to avoid ice formation at temperatures below 35.6°F (2°C). Snap pressure: Full flow when downstream pressure reaches 50% of the inlet pressure.

Ordering Information:

P31TA 9 2 S G N C 2CN

Body size	Actuator interface	Solenoid voltage
Soft start / dump valve (1/4") P31TA	G 15mm solenoid (P31 only)	2CN 24VDC non locking manual override
Soft start / dump valve (1/2") P32TA	C 30mm solenoid	3GN 120VAC non locking manual override
	P Threaded air pilot	1FN 120VAC non locking manual override (P31 series only)
Thread type	Pilot type	Solenoid type
BSPP 1	P External air pilot	C 15mm (P31 series only)
BSPT 2	S Solenoid pilot	A 30mm CNOMO coil (P32 only)
NPT 9		D 30mm CNOMO coil (M12 connection) (P32 only)
Port size		
Global modular mini (1/4") 2		
Global modular compact (1/2") 4		

Note: P32 unit used for both P32 & P33 series

Most popular.

B
Global Air
Preparation

Introduction

Filters

Coalescers

Regulators

Filter /
Regulators

Lubricators

Combinations

Accessories
and Kits



For inventory, lead times, and kit lookup, visit www.pdnplu.com

Combined Soft Start / Dump Valves

Material Specifications

Body	Aluminum
Body cover	Polyester
Seals	Nitrile NBR

Mounting Brackets

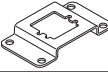
	Description	Part number
	L-bracket mounting kit	P31T
P31		P3HKA00ML
	Foot bracket mounting kit	P3HKA00MC
P31		

Note:

For solenoid operators and cable plugs (connectors) see page B79 and B80.

Air Preparation Products

Global Air Preparation

Flow Charts

P31TA 1/4" Soft Start & Dump Valve

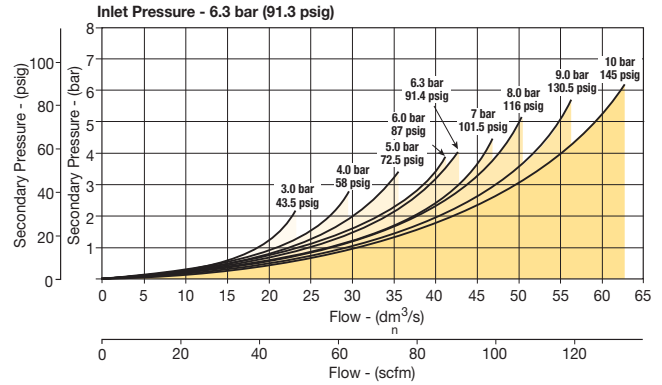

P32TA 1/2" Soft Start & Dump Valve

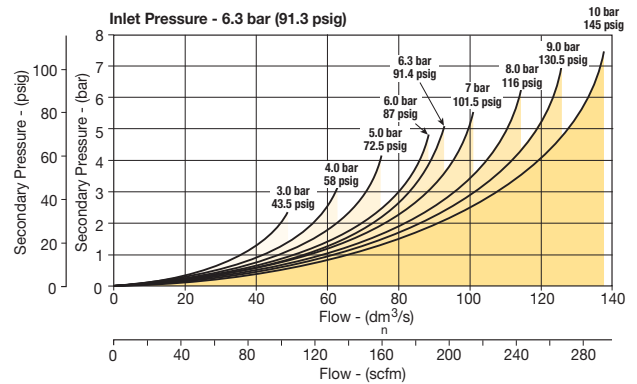

Dimensions inches (mm)

P31T

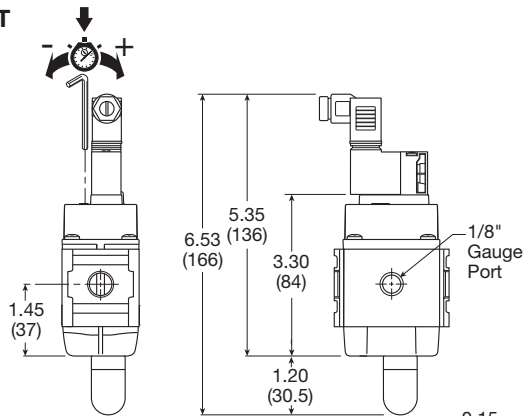

P32T

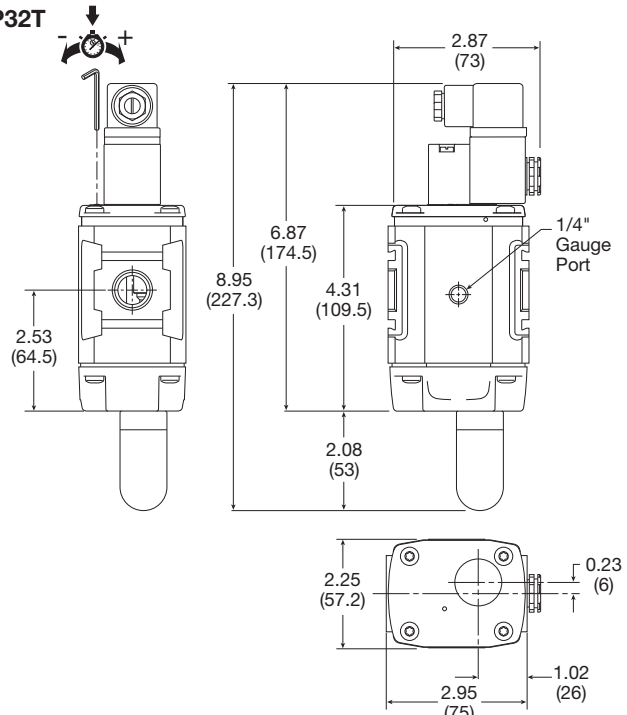

Soft Start Function:

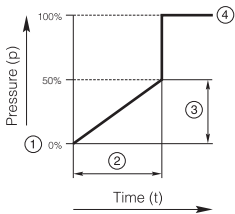

- Start signal
- Switching time delay
- Gradual pressure build up
- Operating pressure $p_2 (=p_1)$



For inventory, lead time, and kit lookup, visit www.pdnplu.com

P33T Redundant Safety Exhaust Valve

- Proven control reliable technology with integrated soft start
- Soft start application of air to the system when energized; can be adjusted for slower or faster buildup of system pressure
- Rapid exhaust of downstream air when de-energized to remove stored energy and allow safe access
- Memory, monitoring, and air flow control functions are integrated into two identical valve elements. Valves lock-out if asynchronous movement of valve elements occurs during actuation or de-actuation, resulting in a residual outlet pressure of less than 1% of supply.
- Reset can only be accomplished by the integrated electrical (solenoid) reset. Cannot be reset by removing and re-applying supply pressure.
- Basic 3/2 normally closed valve function: Dirt tolerant, wear compensating poppet design for quick response and high flow capacity.
- LED indicators of main solenoid operation, reset solenoid operation, and status indicator condition.
- Optional transducer for monitoring of downstream pressure in the system.
- Dual exhaust silencers included.
- Not for use with clutch / brake applications.
- For use in conjunction with a safety relay or safety PLC.



Operating information

Pilot Solenoids:	According to VDE 0580
Enclosure rating:	According to DIN 400 50 IP65
Connector socket:	According to DIN 43650 Form A Three solenoids, rated for continuous duty
Standard voltages:	24VDC
Power consumption (each solenoid), for primary & reset solenoids:	1.2 Watts on DC
Enclosure rating:	IP65, IEC 60529
Electrical connection:	M12, 5-pin
Ambient temperature:	15°F to 122°F (-10°C to 50°C)
Media temperature:	40°F to 175°F (4°C to 80°C)
Flow media:	Compressed Air, Filtered to Minimum 40 Micron
Inlet pressure:	30 to 150 psig (2 to 10 bar)
Monitoring:	Dynamically, cyclically, internally during each actuating and de-actuating movement. Monitoring function has memory and requires an overt act to reset unit after lockout.
Mounting orientation:	Vertically with pilot solenoids on top
Port threads:	3/4 NPT, 3/4 BSPP
Control reliable:	Category 4 (Cat 4); performance Level e (PLe) in accordance with Machine directive - EN ISO 13849-1 (Certification pending)
Weight:	16.1 lb (7.3 kg) w/o transducer 16.3 lb (7.4 kg) w/ transducer

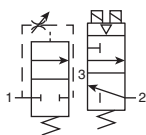

Port size			Cv		Part number*
Inlet	Outlet	Transducer	1 to 2	2 to 3	
3/4	3/4	w/o transducer	3.7	8.5	P33TA96RG4F2CN
3/4	3/4	w/ transducer	3.7	8.5	P33TA96RG4G2CN

* NPT port threads. For BSPP threads, replace "9" in the part number with a "1".

Ordering Information:

P33TA	9	6 R	G 4	F	2CN
Body size Standard P33T	Port size 3/4" 6	Operator 15mm Solenoid G	Solenoid Dual M12 connector without transducer F Triple M12 connector with transducer G	Voltage 24VDC with manual override 2CN	
Thread type BSPP 1 NPT 9	Type Solenoid pilot + gauge R	Mounting Cat 4 w/bracket 4			

Most popular.



For inventory, lead times, and kit lookup, visit www.pdnplu.com

B66

Parker Hannifin Corporation
Pneumatic Division
Richland, Michigan
www.parker.com/pneumatics

B
 Global Air Preparation
 Introduction
 Filters
 Coalescers
 Regulators
 Filter / Regulators
 Lubricators
 Combinations
 Accessories and Kits

Repair and Service Kits

Black grill	1834C05-001
Body connector	P32KA00CB
M12, 5-pin female to flying lead cable, TPE; 6.6 ft (2 m)	RKC 4.5T-2/S1587
M12, 5-pin male to flying lead cable, TPE; 6.6 ft (2 m)	RSC 4.5T-2/S1587
1/2 NPT, port block kit	P32KA94CP
3/4 NPT, port block kit	P32KA96CP
1/2 BSPP, port block kit	P32KA14CP
3/4 BSPP, port block kit	P32KA16CP
1/2 BSPT, port block kit	P32KA24CP
3/4 BSPT, port block kit	P32KA26CP
Pressure switch	1227A30-001
Pressure transducer (optional)	1232H30-001
T-bracket w/ body connector	P32KA00MT
T-bracket (fits to body connector or port block)	P32KA00MB
Silencer(s) 3/4"	5500A5013
Solenoid (main & reset)	1527B7916-001
Square flush mounting gauge kit, 0-160 psig	K4511SCR160

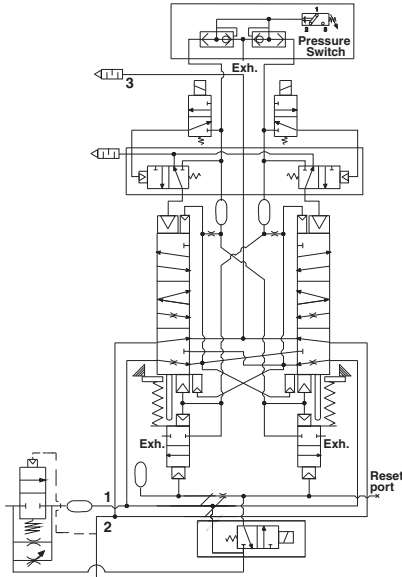

Valve Wiring

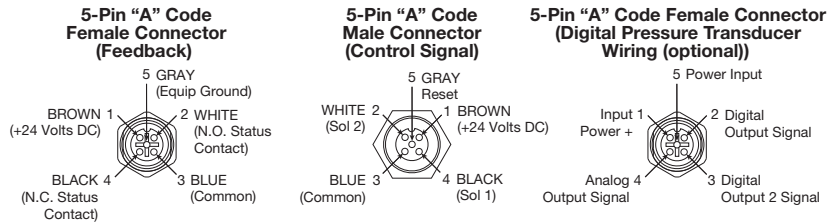

Dimensions inches (mm)

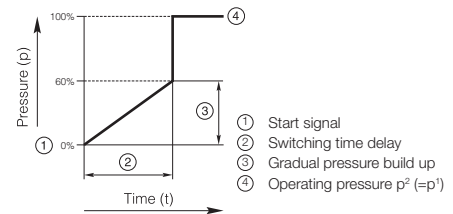
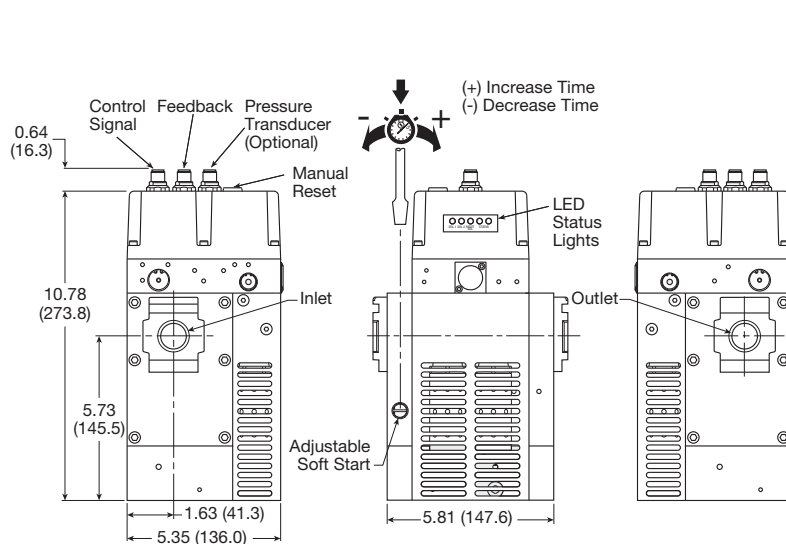

Angle Mounting Bracket

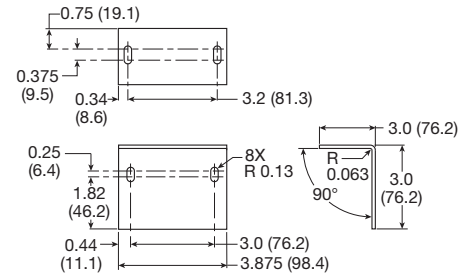

Note: Mounting bracket and installation screws included and required to install unit in the system.



For inventory, lead time, and kit lookup, visit www.pdnplu.com

B67

Valve de-actuated (ready-to-run):

The flow of inlet air pressure to the inlet chamber of the main valve internals is restricted by a fixed orifice and an adjustable flow control as well as an air piloted 2-way normally closed poppet valve. The flow of inlet air pressure into the crossover passages is restricted by the size of the passage between the stem and the valve body opening. Flow is sufficient to quickly pressurize pilot supply / timing chambers 1 and 2. The inlet poppets prevent air flow from crossover passages into the outlet chamber. Air pressure acting on the inlet poppets and return pistons securely hold the valve elements in the closed position. (Reset adapter omitted for clarity.)

The green "Status" LED will be illuminated indicating the valve is operational.

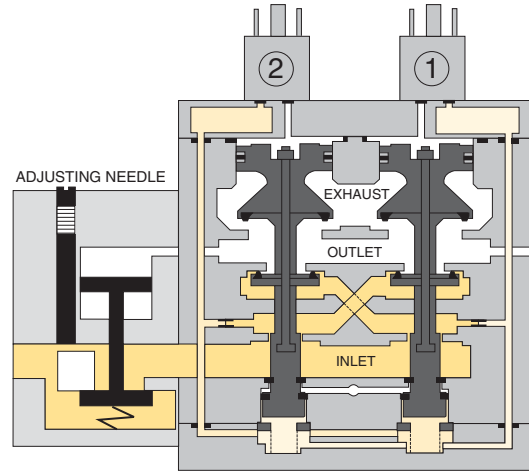
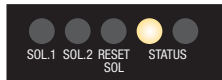

Valve actuated:

Energizing the pilot valves simultaneously applies pressure to both pistons, forcing the internal parts to move to their actuated (open) position, where inlet air flow to crossover passages is fully open, inlet poppets are fully open and exhaust poppets are fully closed. The outlet is then pressurized at a rate allowed by the fixed orifice and the adjusted flow control. Once the air pressure in the outlet chamber reaches approximately 60% of inlet pressure, the air piloted 2-way normally closed poppet valve opens fully and the pressure in the inlet, crossovers, outlet, and timing chambers are quickly equalized. The adjustable flow control will control the time it takes for the outlet air pressure to reach approximately 60% of inlet pressure.

De-energizing the pilots quickly causes the valve elements to return to the ready-to-run position.

Solenoid 1, Solenoid 2 and the green "Status" LED's will be illuminated indicating the valve is operating properly.

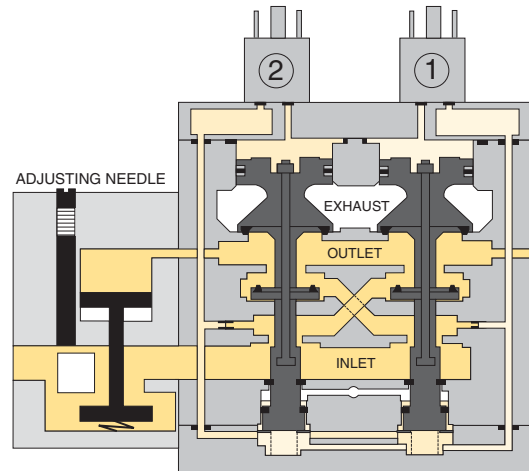
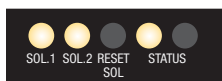

Soft start function:

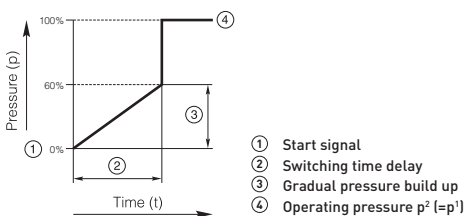

PA

Global Air Preparation

Introduction

Filters

Coalescers

Regulators

Filter / Regulators

Lubricators

Combinations

Accessories and Kits



For inventory, lead times, and kit lookup, visit www.pdnplu.com

B68

Parker Hannifin Corporation
Pneumatic Division
Richland, Michigan
www.parker.com/pneumatics

Valve fault and lock-out:

Whenever the valve elements operate in a sufficiently asynchronous manner, either on actuation or de-actuation, the valve will move to a locked-out position. In the locked-out position, one crossover and its related timing chamber will be exhausted, and the other crossover and its related timing chamber will be fully pressurized. The valve element (side 2) that is partially actuated has pilot air available to fully actuate it, but no air pressure on the return piston to fully de-actuate the valve element.

Air pressure in the crossover acts on the differential of side 2 stem diameters creating a latching force. Side 1 is in a fully closed position, and has no pilot air available to actuate, but has full pressure on the inlet poppet and return piston to hold the element in the fully closed position. Inlet air flow on side 1 into its crossover is restricted, and flows through the open inlet poppet on side 2, through the outlet into the exhaust port, and from the exhaust port to atmosphere. Residual pressure in the outlet is less than 1% of inlet pressure. The return springs are limited in travel, and can only return the valve elements to the intermediate (locked-out) position. Sufficient air pressure acting on the return pistons is needed to return the valve elements to a fully closed position.

The red "Status" LED will be illuminated indicating the valve in fault and lock-out must be reset

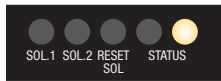

Valve reset (electrical or manual):

The reset procedure is as follows:

- Remove the electrical signals to the main coils
- Ensure there is air supplied to the valve
- Energize the reset solenoid for a minimum of 200 ms
- Allow a 200 ms delay after de-energizing the reset solenoid and re-energizing the main solenoids

The valve will remain in the locked-out position, even if the inlet air supply is removed and re-applied.

A remote reset signal must be applied to reset the valve. A momentary, remote electrical signal must be applied to the reset solenoid to apply pressure to the reset pistons in the valve. Actuation of the reset piston physically pushes the main valve elements to their closed position. Inlet air fully pressurizes the crossovers and holds the inlet poppets on seat. Actuation of the reset piston opens the reset poppet, thereby, immediately exhausting pilot supply air, thus, preventing valve operation during reset (Reset adapter added to illustration.). De-actuation of reset pistons causes the reset poppets to close and pilot supply to fully pressurize. Reset air pressure is applied by a 3/2 normally closed solenoid, or a manual push button mounted on the reset adapter in the top valve cover.

The green "Status" LED will be illuminated once the valve is reset.

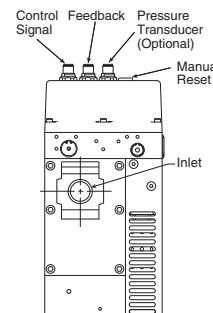
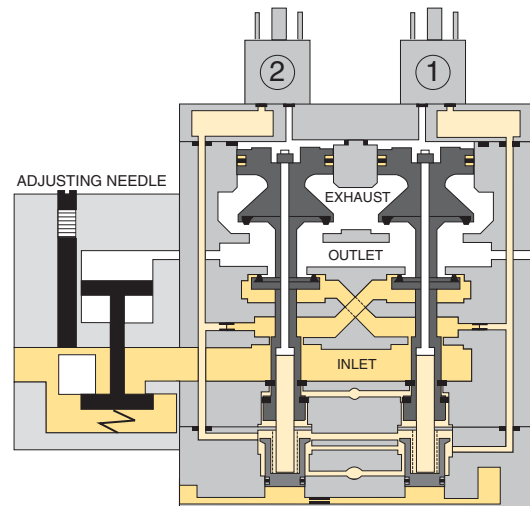
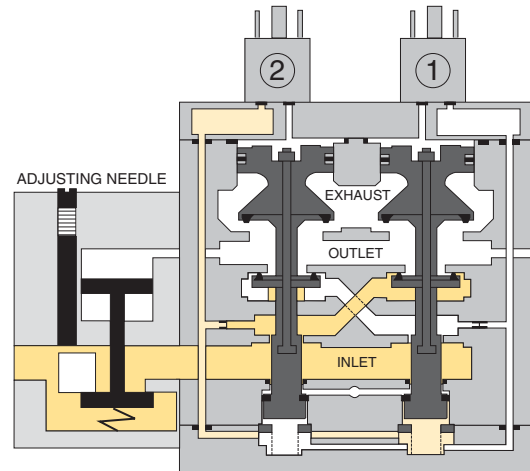
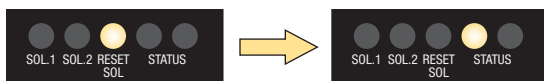

B	Global Air Preparation
	Introduction
Filters	
Coalescers	
Regulators	
Filter/Regulators	
Lubricators	
Combinations	
Accessories and Kits	



For inventory, lead time, and kit lookup, visit www.pdnplu.com

B69

Parker Hannifin Corporation
Pneumatic Division
Richland, Michigan
www.parker.com/pneumatics

Ball Valve / Lockout Valve

The Ball / Lockout Valve shuts off downstream line pressure in the closed position with a 90° turn of the handle. In the closed position, inlet air pressure is blocked and downstream / system air is exhausted through a threaded port. To prevent unauthorized adjustment, the padlock slide may be assembled on either side. It is recommended that this slide is installed after final system assembly.

The Safety Lockout valves conform to OSHA #29 CFR part 1910 — control of hazardous energy source (lockout / tagout).

Note: This padlock slide is a permanent assembly and may not be removed later, any unauthorized tampering will void any warranty claims. The valve can only be locked in the closed position.

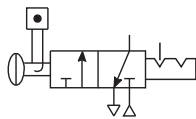
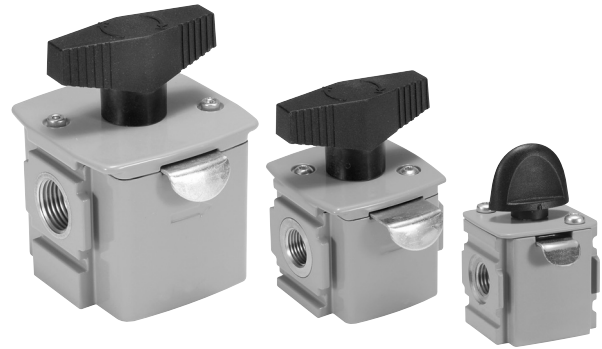

Ordering Information

Model type	Port size	Exhaust port	Thread type	Flow scfm (dm ³ /s, ANR)	Modular ball valve flow from left to right
P31	1/4"	1/4"	NPT	42.4 (20)	P31VB92LBNN
P32	3/8"	1/4"	NPT	190.7 (90)	P32VB93LBNN
	1/2"	1/4"	NPT	258.5 (122)	P32VB94LBNN
P33	1/2"	1/2"	NPT	561.5 (265)	P33VB94LBNN
	3/4"	1/2"	NPT	678 (320)	P33VB96LBNN

* Lockout tab and muffler supplied with unit.

For thread type: BSPP **1**
 BSPT **2**
 NPT **9**

Operating information

Operating temperature:	-40°C to 80°C (-40°F to 176°F)
Pressure supply (max):	250 psig (17 bar)
Port size:	BSPP / BSPT / NPT
	1/4, 3/8, 1/2, 3/4
Weight:	P31 0.33 lbs (0.15 kg)
	P32 0.79 lbs (0.36 kg)
	P33 1.21 lbs (0.55 kg)

Material Specifications

Body	Aluminum
Seals	PTFE
Ball	Stainless Steel
Lockout Tab	Zinc Plated Steel
Screw	Zinc Plated Steel

Dimensions inches (mm)

P31

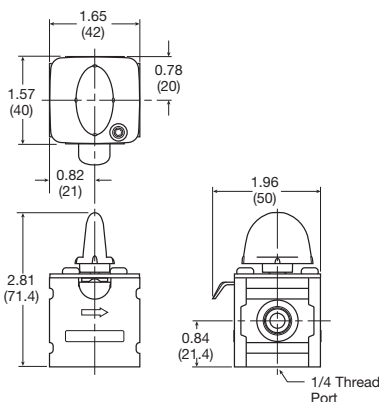

P32

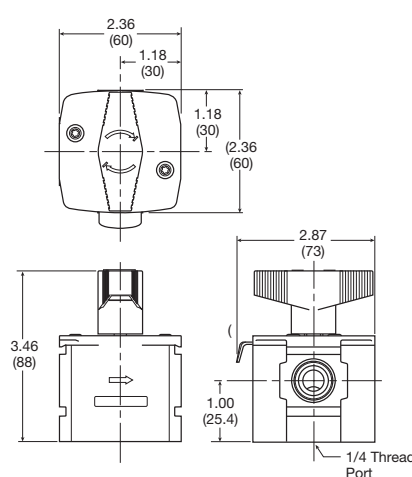

P33

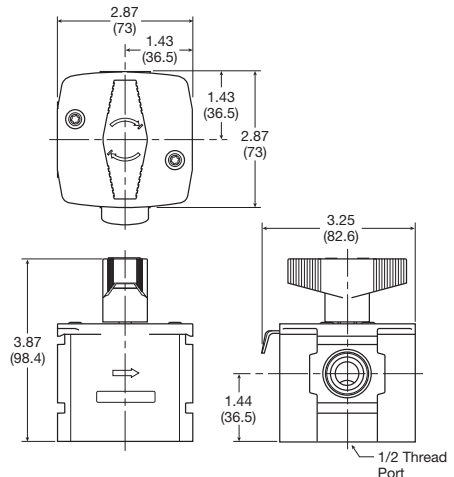

Most popular.



For inventory, lead times, and kit lookup, visit www.pdnplu.com

B70

Parker Hannifin Corporation
 Pneumatic Division
 Richland, Michigan
www.parker.com/pneumatics

Manifold Blocks

- Available in 1/4" or 3/4" threaded inlet / outlet ports
- Two additional top and bottom auxiliary ports standard
- Can be mounted anywhere in the FRL system

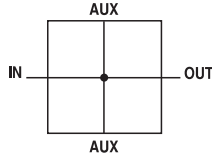

Ordering Information

Model type	In / Out port size	Auxiliary port size top	Auxiliary port size bottom	Thread type	Part number
P31	1/4"	1/4"	1/4"	NPT	P31MA92022N
P32	1/2"	1/4"	1/2"	NPT	P32MA94024N
P33	3/4"	1/4"	1/2"	NPT	P33MA96024N

For thread type: BSPP 1
 BSPT 2
 NPT 9

Operating information

Operating temperature:	-40°F to 150°F (-40°C to 65.5°C)
Pressure supply (max):	300 psig (20.7 bar)
Weight:	P31 0.26 lbs (0.12 kg)
	P32 0.45 lbs (0.20 kg)
	P33 0.45 lbs (0.20 kg)

Material Specifications

Body	Aluminum
------	----------

Dimensions inches (mm)

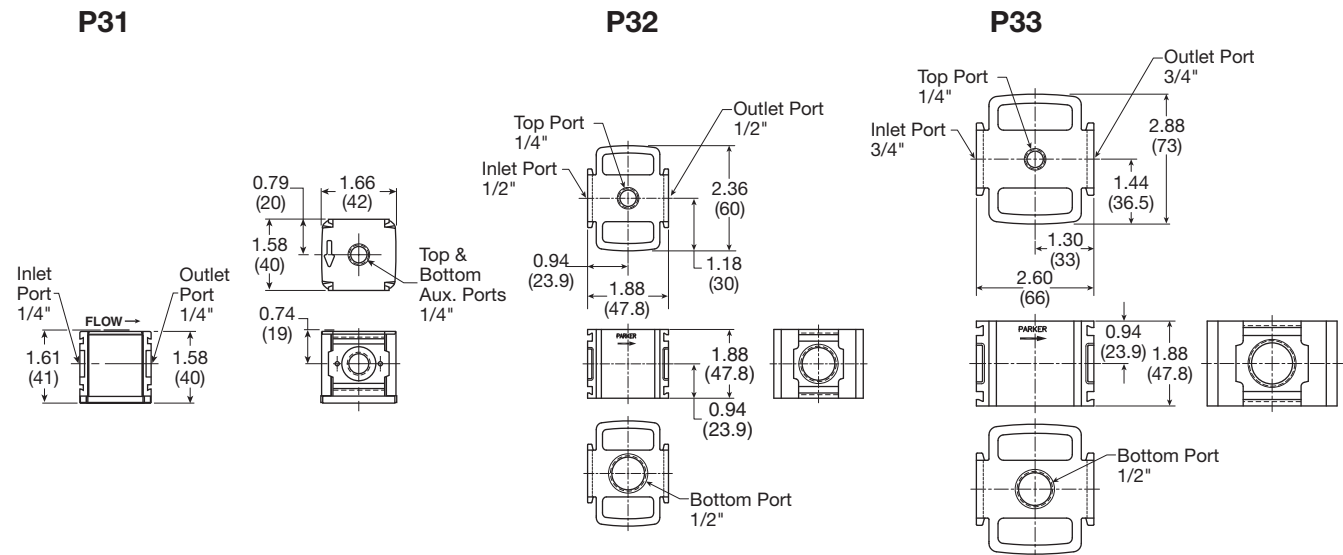

Most popular.



For inventory, lead time, and kit lookup, visit www.pdnplu.com

B71

Parker Hannifin Corporation
 Pneumatic Division
 Richland, Michigan
www.parker.com/pneumatics

PPS1 Pressure Switch

- Long life elastomer diaphragm
- High quality snap action switch
- Field adjustable
- Compact design
- Easily customized
- Quick delivery
- NEMA 4, 13

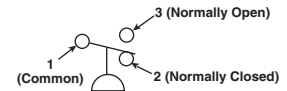

Definitions and Terminology

Repeatability — Accuracy is the maximum allowable set point deviation of a single pressure or temperature switch under one given set of environmental and operational conditions.

Single Pole Double Throw (SPDT) Switching element — A SPDT switching element has one normally open, one normally closed and one common terminal. Three terminals mean that the switch can be wired with the circuit either normally open (NO), or normally closed (NC), or both.

Dead Band — The dead band, sometimes referred to as “differential” or “hysteresis”, is the change in pressure between actuation and deactuation set points.

Operating information

Temperature range:	-40°F to 105°F (-40°C to 220°C)
Operating pressure range:	1, 2, 3 - 250 PSI (17.2 bar) 4 - 2000 PSI (137.9 bar)
Set point tolerance	±1 PSI or 5% (.07 bar)
Deadband	10 - 20% of set pressure
Current rating	3A @ 125 VAC 2A @ 30 VDC (Resistive)
Circuit form	SPDT Standard
Cycle life	1 Million

Ordering Information:

PPS1	-	1	C	3	-	R	HM																						
		<table border="1"> <thead> <tr><th>Thread</th><th></th></tr> </thead> <tbody> <tr><td>1/4" NPT male</td><td>1</td></tr> <tr><td>1/8" NPT male</td><td>2</td></tr> <tr><td>1/4" BSPP male</td><td>17</td></tr> <tr><td>1/8" BSPP male</td><td>18</td></tr> </tbody> </table>		Thread		1/4" NPT male	1	1/8" NPT male	2	1/4" BSPP male	17	1/8" BSPP male	18	<table border="1"> <thead> <tr><th>Set Point Direction</th><th></th></tr> </thead> <tbody> <tr><td>R</td><td>Rising</td></tr> </tbody> </table>		Set Point Direction		R	Rising	<table border="1"> <thead> <tr><th>Electrical Connection</th><th></th></tr> </thead> <tbody> <tr><td>HM</td><td>DIN 9.4mm</td></tr> <tr><td>WL</td><td>Wire leads 18"</td></tr> </tbody> </table>		Electrical Connection		HM	DIN 9.4mm	WL	Wire leads 18"		
Thread																													
1/4" NPT male	1																												
1/8" NPT male	2																												
1/4" BSPP male	17																												
1/8" BSPP male	18																												
Set Point Direction																													
R	Rising																												
Electrical Connection																													
HM	DIN 9.4mm																												
WL	Wire leads 18"																												
		<table border="1"> <thead> <tr><th>Circuit</th><th></th></tr> </thead> <tbody> <tr><td>SPDT</td><td>C</td></tr> </tbody> </table>		Circuit		SPDT	C	<table border="1"> <thead> <tr><th>Range*</th><th></th></tr> </thead> <tbody> <tr><td>1</td><td>3-10 PSI</td></tr> <tr><td>2</td><td>6-30 PSI</td></tr> <tr><td>3</td><td>20-120 PSI</td></tr> <tr><td>4†</td><td>100-400 PSI</td></tr> </tbody> </table>		Range*		1	3-10 PSI	2	6-30 PSI	3	20-120 PSI	4†	100-400 PSI	<p>* Factory setting for calibration purposes Range 1 = 6 PSI Range 2 = 18 PSI Range 3 = 70 PSI Range 4 = 250 PSI</p>									
Circuit																													
SPDT	C																												
Range*																													
1	3-10 PSI																												
2	6-30 PSI																												
3	20-120 PSI																												
4†	100-400 PSI																												
		<p>† Only available in 1/4" NPT</p>																											

Note: Switch is field adjustable.

Material Specifications

Adjustment knob	Anodized aluminum
Body	Brass
Diaphragm	Nitrile

Operation

The pressure switch monitors the air pressure in your pneumatic system. When the pressure in your system either drops below or exceeds the set point pressure, an electrical output is given.

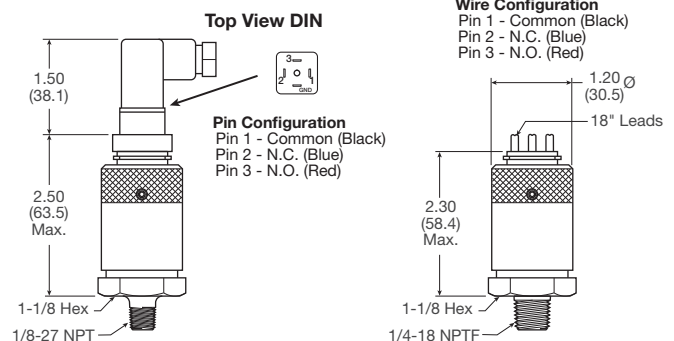
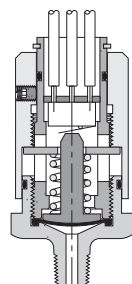

For inventory, lead times, and kit lookup, visit www.pdnplu.com

B72

Parker Hannifin Corporation
 Pneumatic Division
 Richland, Michigan
www.parker.com/pneumatics

P31 Accessories

C-Bracket
 (Fits to filter and lubricator body)
P31KA00MW

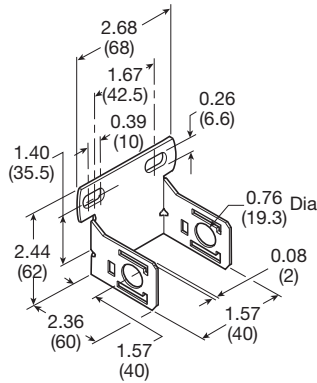
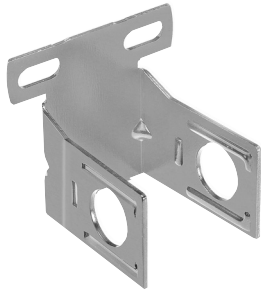

T-Bracket w/ Body Connector
 (O-ring not shown)
P31KA00MT

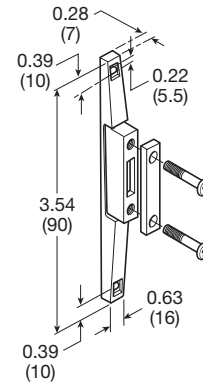

Body Connector
 (O-ring not shown)
P31KA00CB

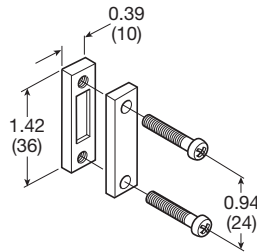
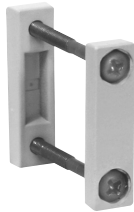

Port Block Kit
 (O-ring not shown)

- | | | | |
|----------------|------------------|----------------|------------------|
| 1/8 NPT | P31KA91CP | 1/8 BSPT | P31KA21CP |
| 1/4 NPT | P31KA92CP | 1/4 BSPT | P31KA22CP |
| 3/8 NPT | P31KA93CP | 3/8 BSPT | P31KA23CP |
| 1/8 BSPP | P31KA11CP | | |
| 1/4 BSPP | P31KA12CP | | |
| 3/8 BSPP | P31KA13CP | | |



Port Block Kit w/ T-Bracket
 (O-ring not shown)

- | | | | |
|----------------|------------------|----------------|------------------|
| 1/8 NPT | P31KA91CN | 1/8 BSPT | P31KA21CN |
| 1/4 NPT | P31KA92CN | 1/4 BSPT | P31KA22CN |
| 3/8 NPT | P31KA93CN | 3/8 BSPT | P31KA23CN |
| 1/8 BSPP | P31KA11CN | | |
| 1/4 BSPP | P31KA12CN | | |
| 3/8 BSPP | P31KA13CN | | |



Angle Bracket
 (Fits to regulator and filter/regulator body)
P31KB00MR

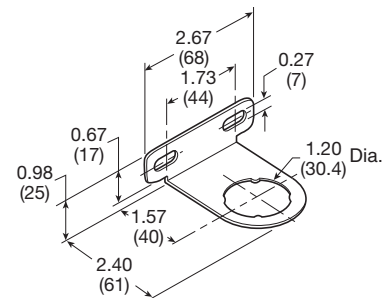

B

Global Air Preparation

Introduction

Filters

Coalescers

Regulators

Filter/Regulators

Lubricators

Combinations

Accessories and Kits



For inventory, lead time, and kit lookup, visit www.pdnplu.com

P32 Accessories

T-Bracket w/ Body Connector

P32KA00MT

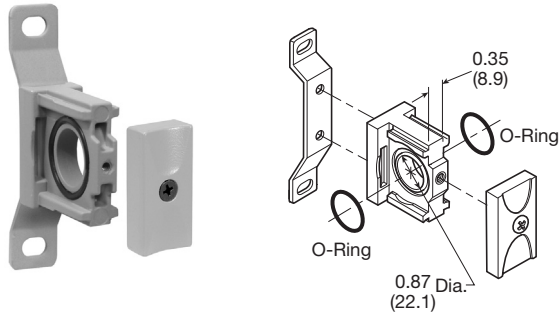

Body Connector

P32KA00CB

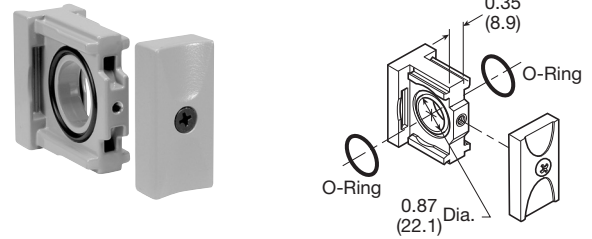

Port Block Kit

1/4 NPT.....	P32KA92CP	1/4 BSPT	P32KA22CP
3/8 NPT.....	P32KA93CP	3/8 BSPT	P32KA23CP
1/2 NPT.....	P32KA94CP	1/2 BSPT	P32KA24CP
3/4 NPT.....	P32KA96CP	3/4 BSPT	P32KA26CP
1/4 BSPP	P32KA12CP		
3/8 BSPP	P32KA13CP		
1/2 BSPP	P32KA14CP		
3/4 BSPP	P32KA16CP		



Angle Bracket

(Fits to regulator and filter/regulator bonnet)

P32KB00MR

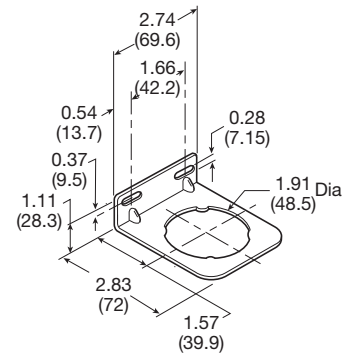

L-Bracket

(Fits to filter and lubricator body)

P32KA00ML

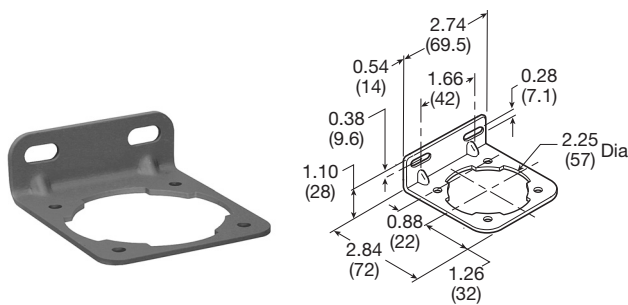

T-Bracket

(fits to body connector or port block)

P32KA00MB

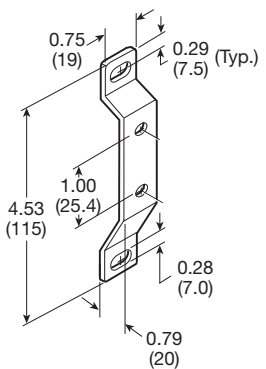

B
 Global Air Preparation
 Introduction
 Filters
 Coalescers
 Regulators
 Filter / Regulators
 Lubricators
 Combinations
 Accessories and Kits



For inventory, lead times, and kit lookup, visit www.pdnplu.com

P33 Accessories

T-Bracket w/ Body Connector

P32KA00MT

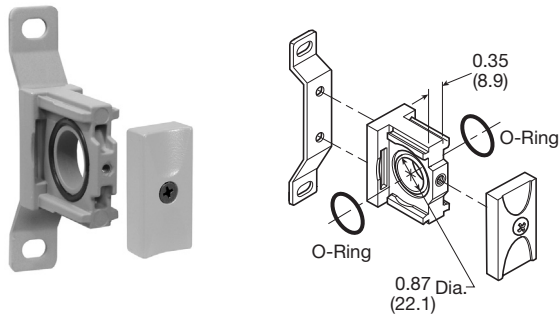

Body Connector

P32KA00CB

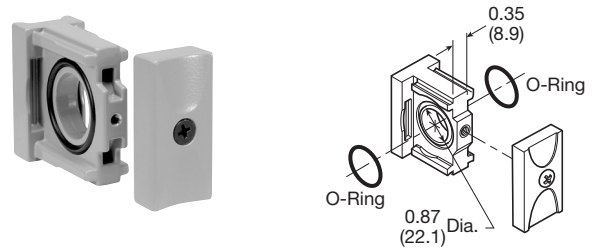

Port Block Kit

- | | | | |
|----------------|------------------|----------------|------------------|
| 1/4 NPT..... | P32KA92CP | 1/4 BSPT | P32KA22CP |
| 3/8 NPT..... | P32KA93CP | 3/8 BSPT | P32KA23CP |
| 1/2 NPT..... | P32KA94CP | 1/2 BSPT | P32KA24CP |
| 3/4 NPT..... | P32KA96CP | 3/4 BSPT | P32KA26CP |
| 1/4 BSPP | P32KA12CP | | |
| 3/8 BSPP | P32KA13CP | | |
| 1/2 BSPP | P32KA14CP | | |
| 3/4 BSPP | P32KA16CP | | |



Angle Bracket

(Fits to regulator and filter/regulator bonnet)

P33KA00MR

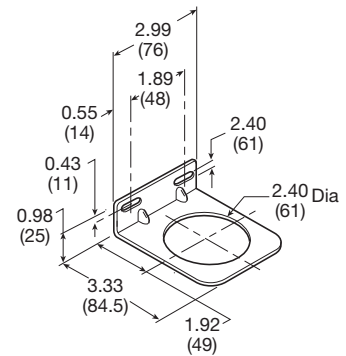

L-Bracket

(Fits to filter and lubricator body)

P33KA00ML

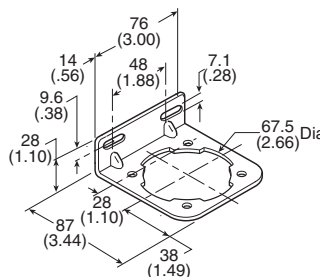

T-Bracket

(fits to body connector or port block)

P32KA00MB

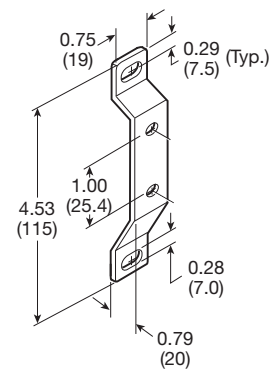











B
 Global Air Preparation
 Introduction
 Filters
 Coalescers
 Regulators
 Filter / Regulators
 Lubricators
 Combinations
 Accessories and Kits

Series	Description	Part number	
P31 P32 P33	Panel Mount Nut (Plastic)	P31KA00MP P32KA00MP P33KA00MP	
P31 P32 P33	Panel Mount Nut (Aluminum)	P31KA00MM P32KA00MM P33KA00MM	
P31 P32 P33	5µ Element Kit	P31KA00ESE P32KA00ESE P33KA00ESE	
P31 P32 P33	1µ Element Kit	P31KA00ES9 P32KA00ES9 P33KA00ES9	
P31 P32 P33	0.01µ Element Kit	P31KA00ESC P32KA00ESC P33KA00ESC	
P31 P32 P33	Adsorber Element Kit	P31KA00ESA P32KA00ESA P33KA00ESA	
P32 / P33	Auto Drain Kit	P32KA00DA	
P31 P32 / P33	Differential Pressure Indicator Kit	P31KB00RQ P32KA00RQ	
P31 / P32 / P33	Drip Control Assembly Kit	P32KA00PH	
P31 P32 / P33	Fill Plug Kit	P31KA00PL P32KA00PL	
P31 P32 P33	Lubricator - Plastic Bowl w/ Bowl Guard No Drain	P31KB00BGN P32KB00BGN P33KA00BGN	



For inventory, lead times, and kit lookup, visit www.pdnplu.com

Series	Description	Part number	
P31 P32 P33	Lubricator - Metal Bowl w/o Sight Gauge No Drain	P31KB00BMN P32KB00BMN P33KA00BMN	
P32 P33	Lubricator - Metal Bowl w/ Sight Gauge No Drain	P32KB00BSN P33KA00BSN	
P31 P32 P33	Metal Bowl w/o Sight Gauge & Manual Drain	P31KB00BMM P32KB00BMM P33KA00BMM	
P31	Metal Bowl w/o Sight Gauge & Pulse Drain	P31KB00BMB	
P32 P33	Metal Bowl w/o Sight Gauge & Auto Drain	P32KB00BMA P33KA00BMA	
P32 P33	Metal Bowl w/ Sight Gauge & Manual Drain	P32KB00BSM P33KA00BSM	
P32 P33	Metal Bowl w/ Sight Gauge & Auto Drain	P32KB00BSA P33KA00BSA	
P31 P32 P33	Plastic Bowl w/ Bowl Guard & Manual Drain	P31KB00BGM P32KB00BGM P33KA00BGM	
P31	Plastic Bowl w/ Bowl Guard & Pulse Drain	P31KB00BGB	
P32 P33	Plastic Bowl w/ Bowl Guard & Auto Drain	P32KB00BGA P33KA00BGA	
P31 P32 P33	Regulator - Relieving Repair Kit	P31KB00RB P32KB00RB P33KA00RB	
P31 P32 P33	Regulator - Non-Relieving Repair Kit	P31KB00RC P32KB00RC P33KA00RC	

B

Global Air
Preparation

Introduction

Filters

Coalescers

Regulators

Filter/
Regulators

Lubricators





Combinations

Accessories
and Kits

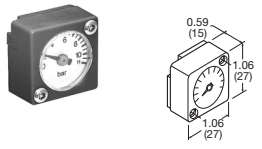
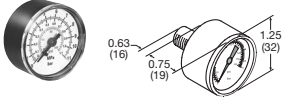
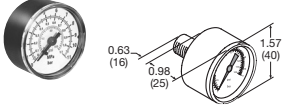
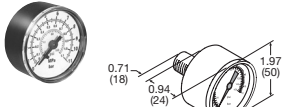

For inventory, lead time, and kit lookup, visit www.pdnplu.com

PD
Global Air Preparation
Introduction
Filters
Coalescers
Regulators
Filter / Regulators
Lubricators
Combinations
Accessories and Kits

Series	Description	Connection	Part number	
P31 P32 P33	Regulator - Main Adjusting Spring 0-30 psig (0-2 bar) Kit		P31KB00PR P32KB00PR P33KA00PR	
P31 P32 P33	Regulator - Main Adjusting Spring 0-60 psig (0-4.1 bar) Kit		P31KB00PS P32KB00PS P33KA00PS	
P31 P32 P33	Regulator - Main Adjusting Spring 0-125 psig (0-8.6 bar) Kit		P31KB00PT P32KB00PT P33KA00PT	
P31 P32 P33	Regulator - Main Adjusting Spring 0-250 psig (0-17 bar) Kit		P31KB00PV P32KB00PV P33KA00PV	
P31	Square Flush Mounting Gauge Kit	0-60 psig 0-160 psig 0-4 bar 0-11 bar	K4511SCR060 K4511SCR160 K4511SCR04B K4511SCR11B	
P31 / P32	Square Mounting Gauge with Adapter Kit	0-60 psig 0-160 psig 0-4 bar 0-11 bar	P6G-PR90060 P6G-PR90160 P6G-PR10040 P6G-PR10110	
P31	1" Round Gauge	0-60 psig / 0-4.1 bar 1/8" 0-160 psig / 0-10 bar 1/8"	K4510N18060 K4510N18160	
P31	40mm Round Gauge	0-30 psig / 0-2 bar 1/8" 0-60 psig / 0-4.1 bar 1/8" 0-160 psig / 0-10 bar 1/8"	K4515N18030 K4515N18060 K4515N18160	
P32 / P33	50mm Round Gauge	0-30 psig / 0-2 bar 1/4" 0-60 psig / 0-4.1 bar 1/4" 0-160 psig / 0-10 bar 1/4" 0-300 psig / 0-20 bar 1/4"	K4520N14030 K4520N14060 K4520N14160 K4520N14300	
P31 P32 / P33	Body Connector O-ring (Replacement kit) (Pack of 10)		P31KA00CY P32KA00CY	
P31 P32	Tamperproof Knob Kit		P31KB00AT P32KB00AT	
P31 P32	Tamperproof Lockable Kit		P31KB00AL P32KB00AL	



For inventory, lead times, and kit lookup, visit www.pdnplu.com

Solenoid Operators - CNOMO

Solenoid operators, coil combinations

	NC Normal Operator with 22 x 30 standard coil	NC Normal Operator with 30 x 30 standard coil
Working pressure	0 to 10 bar	0 to 10 bar
Ambient temperature	-10°C to 60°C *	-10°C to 60°C *
Power (DC)	4.8W	2.7W
Power (AC)	8.5VA	4.9VA
Voltage tolerance	+/-10%	+/-10%
Duty cycle	100%	100%
Insulation class	F	F
Electric connection	B Industrial	DIN 43650A
Protection	IP65	IP65
Approval		UL/CSA
Working media	All neutral media such as compressed air	

* Limited to 50°C if use with 100% duty cycle

Transients

Interrupting the current through the solenoid coil produces momentary voltage peaks which, under unfavorable conditions, can amount to several hundred times the rated operating voltage. Normally, these transients do not cause problems, but to achieve the Maximum life of relays in the circuit (and particularly of transistors, thyristors and integrated circuits) it is desirable to provide protection by means of voltage-dependent resistors (varistors). All connectors/cable plugs EN175301-803 with LED's include this type of circuit protection.

Materials

Pilot Valve

Body:	Polyamide
Armature tube:	Brass
Plunger & core:	Corrosion resistant Cr-Ni steel
Seals:	Fluorocarbon
Screws:	Stainless steel

Coil

Encapsulation material:	Thermoplastic as standard Duroplast for M12 connection
-------------------------	---

P31 Series only - Solenoid coils 15mm NC

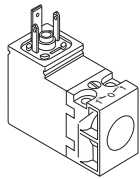

Voltage	Order code Override, blue, non-locking flush	Weight (Kg)
24VDC	PS2982B49P	0.038
115VAC 50Hz / 120VAC 60Hz	PS2982B53P	0.038

Solenoid Coils with M12 Connection

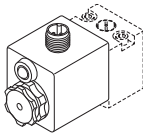

Voltage	Part number	Weight (Kg)
Direct current		
24VDC	P2FC6449	0.065

Spare Base Solenoid Pilot Operator CNOMO NC

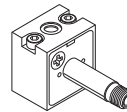

Description	Part number non-lock manual override	Weight (Kg)
Standard Duty	P2FP23N4B	0.065
No Override	P2FP23N4A	0.065

Note: Solenoid pilot operators are fitted to the Global range. Order the above part numbers for spares. The operators are supplied with mounting screws and interface 'O' rings. Coils and connectors must be ordered separately.

Solenoid Coils with DIN A or Industrial B Connection

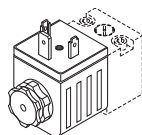

Voltage	22mm x 30mm Part number B industrial standard	Weight (Kg)	30mm x 30mm Part number DIN 43650A standard	Weight (Kg)
Direct current				
24VDC	P2FCB449	0.093	P2FCA449	0.105
Alternative current				
110V 50Hz, 120V 60Hz	P2FCB453	0.093	P2FCA453	0.105

Most popular.



For inventory, lead time, and kit lookup, visit www.pdnplu.com

Solenoid Connectors / Cable Plugs EN175301-803

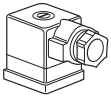
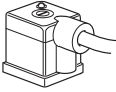
	Description	Part number 22mm Form B Industrial	Part number 30mm Form A DIN 43650A
	With standard screw	PS2429BP	PS2028BP
	With LED and protection 24VAC/DC	PS243079BP	PS203279BP
	With LED and protection 110VAC	PS243083BP	PS203283BP
	With cable	PS2429JBP	PS2028JCP
	24VAC/DC, 2m cable LED and protection IP65	PS2430J79BP	PS2032J79CP
	110VAC/DC, 2m cable LED and protection IP65	PS2430J83BP	PS2032J83CP

Solenoid coil dimensions inches (mm)

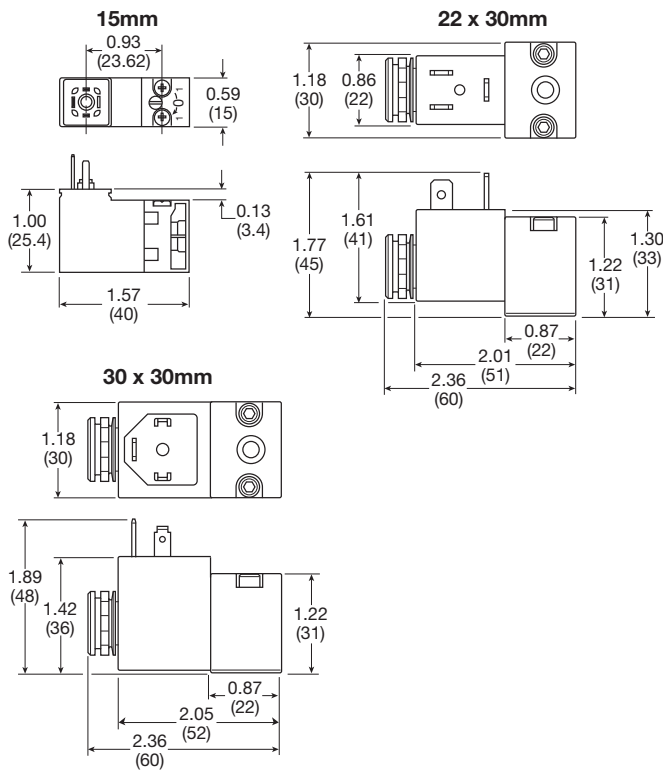

Electrical schematics



PS2028BP	PS243079BP	PS203279BP
PS2028JBP	PS2430J79BP	PS2032J79CP
PS2429BP	PS243083BP	PS203283BP
PS2429JBP	PS2430J83BP	PS2032J83CP
PS2932BP	PS294679BP	PS294683BP
PS2932JBP	PS2946J79BP	PS2946J83BP

Cable plug dimensions inches (mm)

22mm Form B Industrial Cable plugs	PS2429BP	30mm DIN 43650A Cable plugs	PS2028BP
---------------------------------------	-----------------	--------------------------------	-----------------

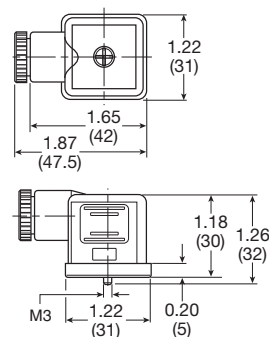
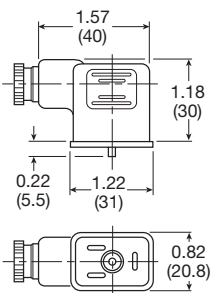

Most popular.



For inventory, lead times, and kit lookup, visit www.pdnplu.com

B80

Parker Hannifin Corporation
 Pneumatic Division
 Richland, Michigan
www.parker.com/pneumatics

Safety Guide For Selecting And Using Pneumatic Division Products And Related Accessories

WARNING:

FAILURE OR IMPROPER SELECTION OR IMPROPER USE OF PNEUMATIC DIVISION PRODUCTS, ASSEMBLIES OR RELATED ITEMS ("PRODUCTS") CAN CAUSE DEATH, PERSONAL INJURY, AND PROPERTY DAMAGE. POSSIBLE CONSEQUENCES OF FAILURE OR IMPROPER SELECTION OR IMPROPER USE OF THESE PRODUCTS INCLUDE BUT ARE NOT LIMITED TO:

- Unintended or mistimed cycling or motion of machine members or failure to cycle
- Work pieces or component parts being thrown off at high speeds.
- Failure of a device to function properly for example, failure to clamp or unclamp an associated item or device.
- Explosion
- Suddenly moving or falling objects.
- Release of toxic or otherwise injurious liquids or gasses.

Before selecting or using any of these Products, it is important that you read and follow the instructions below.

1. GENERAL INSTRUCTIONS

- 1.1. Scope:** This safety guide is designed to cover general guidelines on the installation, use, and maintenance of Pneumatic Division Valves, FRLs (Filters, Pressure Regulators, and Lubricators), Vacuum products and related accessory components.
- 1.2. Fail-Safe:** Valves, FRLs, Vacuum products and their related components can and do fail without warning for many reasons. Design all systems and equipment in a fail-safe mode, so that failure of associated valves, FRLs or Vacuum products will not endanger persons or property.
- 1.3 Relevant International Standards:** For a good guide to the application of a broad spectrum of pneumatic fluid power devices see: ISO 4414:1998, Pneumatic Fluid Power – General Rules Relating to Systems. See www.iso.org for ordering information.
- 1.4. Distribution:** Provide a copy of this safety guide to each person that is responsible for selection, installation, or use of Valves, FRLs or Vacuum products. Do not select, or use Parker valves, FRLs or vacuum products without thoroughly reading and understanding this safety guide as well as the specific Parker publications for the products considered or selected.
- 1.5. User Responsibility:** Due to the wide variety of operating conditions and applications for valves, FRLs, and vacuum products Parker and its distributors do not represent or warrant that any particular valve, FRL or vacuum product is suitable for any specific end use system. This safety guide does not analyze all technical parameters that must be considered in selecting a product. The user, through its own analysis and testing, is solely responsible for:
 - Making the final selection of the appropriate valve, FRL, Vacuum component, or accessory.
 - Assuring that all user's performance, endurance, maintenance, safety, and warning requirements are met and that the application presents no health or safety hazards.
 - Complying with all existing warning labels and / or providing all appropriate health and safety warnings on the equipment on which the valves, FRLs or Vacuum products are used; and,
 - Assuring compliance with all applicable government and industry standards.
- 1.6. Safety Devices:** Safety devices should not be removed, or defeated.
- 1.7. Warning Labels:** Warning labels should not be removed, painted over or otherwise obscured.
- 1.8. Additional Questions:** Call the appropriate Parker technical service department if you have any questions or require any additional information. See the Parker publication for the product being considered or used, or call 1-800-CPARKER, or go to www.parker.com, for telephone numbers of the appropriate technical service department.

2. PRODUCT SELECTION INSTRUCTIONS

- 2.1. Flow Rate:** The flow rate requirements of a system are frequently the primary consideration when designing any pneumatic system. System components need to be able to provide adequate flow and pressure for the desired application.
- 2.2. Pressure Rating:** Never exceed the rated pressure of a product. Consult product labeling, Pneumatic Division catalogs or the instruction sheets supplied for maximum pressure ratings.
- 2.3. Temperature Rating:** Never exceed the temperature rating of a product. Excessive heat can shorten the life expectancy of a product and result in complete product failure.
- 2.4. Environment:** Many environmental conditions can affect the integrity and suitability of a product for a given application. Pneumatic Division products are designed for use in general purpose industrial applications. If these products are to be used in unusual circumstances such as direct sunlight and/or corrosive or caustic environments, such use can shorten the useful life and lead to premature failure of a product.
- 2.5. Lubrication and Compressor Carryover:** Some modern synthetic oils can and will attack nitrile seals. If there is any possibility of synthetic oils or greases migrating into the pneumatic components check for compatibility with the seal materials used. Consult the factory or product literature for materials of construction.
- 2.6. Polycarbonate Bowls and Sight Glasses:** To avoid potential polycarbonate bowl failures:
 - Do not locate polycarbonate bowls or sight glasses in areas where they could be subject to direct sunlight, impact blow, or temperatures outside of the rated range.
 - Do not expose or clean polycarbonate bowls with detergents, chlorinated hydro-carbons, ketones, esters or certain alcohols.
 - Do not use polycarbonate bowls or sight glasses in air systems where compressors are lubricated with fire resistant fluids such as phosphate ester and di-ester lubricants.



2.7. Chemical Compatibility: For more information on plastic component chemical compatibility see Pneumatic Division technical bulletins Tec-3, Tec-4, and Tec-5

- 2.8. Product Rupture:** Product rupture can cause death, serious personal injury, and property damage.
- Do not connect pressure regulators or other Pneumatic Division products to bottled gas cylinders.
 - Do not exceed the maximum primary pressure rating of any pressure regulator or any system component.
 - Consult product labeling or product literature for pressure rating limitations.

3. PRODUCT ASSEMBLY AND INSTALLATION INSTRUCTIONS

- 3.1. Component Inspection:** Prior to assembly or installation a careful examination of the valves, FRLs or vacuum products must be performed. All components must be checked for correct style, size, and catalog number. DO NOT use any component that displays any signs of nonconformance.
- 3.2. Installation Instructions:** Parker published Installation Instructions must be followed for installation of Parker valves, FRLs and vacuum components. These instructions are provided with every Parker valve or FRL sold, or by calling 1-800-CPARKER, or at www.parker.com.
- 3.3. Air Supply:** The air supply or control medium supplied to Valves, FRLs and Vacuum components must be moisture-free if ambient temperature can drop below freezing

4. VALVE AND FRL MAINTENANCE AND REPLACEMENT INSTRUCTIONS

4.1. Maintenance: Even with proper selection and installation, valve, FRL and vacuum products service life may be significantly reduced without a continuing maintenance program. The severity of the application, risk potential from a component failure, and experience with any known failures in the application or in similar applications should determine the frequency of inspections and the servicing or replacement of Pneumatic Division products so that products are replaced before any failure occurs. A maintenance program must be established and followed by the user and, at minimum, must include instructions 4.2 through 4.9.

4.2. Installation and Service Instructions: Before attempting to service or replace any worn or damaged parts consult the appropriate Service Bulletin for the valve or FRL in question for the appropriate practices to service the unit in question. These Service and Installation Instructions are provided with every Parker valve and FRL sold, or are available by calling 1-800-CPARKER, or by accessing the Parker web site at www.parker.com.

4.3. Lockout / Tagout Procedures: Be sure to follow all required lockout and tagout procedures when servicing equipment. For more information see: OSHA Standard – 29 CFR, Part 1910.147, Appendix A, The Control of Hazardous Energy – (Lockout / Tagout)

- 4.4. Visual Inspection:** Any of the following conditions requires immediate system shut down and replacement of worn or damaged components:
- Air leakage: Look and listen to see if there are any signs of visual damage to any of the components in the system. Leakage is an indication of worn or damaged components.
 - Damaged or degraded components: Look to see if there are any visible signs of wear or component degradation.
 - Kinked, crushed, or damaged hoses. Kinked hoses can result in restricted air flow and lead to unpredictable system behavior.
 - Any observed improper system or component function: Immediately shut down the system and correct malfunction.
 - Excessive dirt build-up: Dirt and clutter can mask potentially hazardous situations.

Caution: Leak detection solutions should be rinsed off after use.

4.5. Routine Maintenance Issues:

- Remove excessive dirt, grime and clutter from work areas.
- Make sure all required guards and shields are in place.

4.6. Functional Test: Before initiating automatic operation, operate the system manually to make sure all required functions operate properly and safely.

4.7. Service or Replacement Intervals: It is the user's responsibility to establish appropriate service intervals. Valves, FRLs and vacuum products contain components that age, harden, wear, and otherwise deteriorate over time. Environmental conditions can significantly accelerate this process. Valves, FRLs and vacuum components need to be serviced or replaced on routine intervals. Service intervals need to be established based on:

- Previous performance experiences.
- Government and / or industrial standards.
- When failures could result in unacceptable down time, equipment damage or personal injury risk.

4.8. Servicing or Replacing of any Worn or Damaged Parts: To avoid unpredictable system behavior that can cause death, personal injury and property damage:

- Follow all government, state and local safety and servicing practices prior to service including but not limited to all OSHA Lockout Tagout procedures (OSHA Standard – 29 CFR, Part 1910.147, Appendix A, The Control of Hazardous Energy – Lockout / Tagout).
- Disconnect electrical supply (when necessary) before installation, servicing, or conversion.
- Disconnect air supply and depressurize all air lines connected to system and Pneumatic Division products before installation, service, or conversion.
- Installation, servicing, and / or conversion of these products must be performed by knowledgeable personnel who understand how pneumatic products are to be applied.
- After installation, servicing, or conversions air and electrical supplies (when necessary) should be connected and the product tested for proper function and leakage. If audible leakage is present, or if the product does not operate properly, do not put product or system into use.
- Warnings and specifications on the product should not be covered or painted over. If masking is not possible, contact your local representative for replacement labels.

4.9. Putting Serviced System Back into Operation: Follow the guidelines above and all relevant Installation and Maintenance Instructions supplied with the valve FRL or vacuum component to insure proper function of the system.

Part Number
Index

Safety Guide

Offer of Sale

Part Number Index,
Safety Guide, Offer of Sale



For inventory, lead time, and kit lookup, visit www.pdnplu.com

The goods, services or work (referred to as the "Products") offered by **Parker-Hannifin Corporation**, its subsidiaries, groups, divisions, and authorized distributors ("Seller") are offered for sale at prices indicated in the offer, or as may be established by Seller. The offer to sell the Products and acceptance of Seller's offer by any customer ("Buyer") is contingent upon, and will be governed by all of the terms and conditions contained in this Offer of Sale. Buyer's order for any Products specified in Buyer's purchase document or Seller's offer, proposal or quote ("Quote") attached to the purchase order, when communicated to Seller verbally, or in writing, shall constitute acceptance of this offer.

- 1. Terms and Conditions.** Seller's willingness to offer Products for sale or accept an order for Products is subject to the terms and conditions contained in this Offer of Sale or any newer version of the same, published by Seller electronically at www.parker.com/saleterms/. Seller objects to any contrary or additional terms or conditions of Buyer's order or any other document or other communication issued by Buyer.
- 2. Price; Payment.** Prices stated on Seller's Quote are valid for thirty (30) days, except as explicitly otherwise stated therein, and do not include any sales, use, or other taxes or duties unless specifically stated. Seller reserves the right to modify prices to adjust for any raw material price fluctuations. Unless otherwise specified by Seller, all prices are F.C.A. Seller's facility (INCOTERMS 2010). Payment is subject to credit approval and payment for all purchases is due thirty (30) days from the date of invoice (or such date as may be specified by Seller's Credit Department). Unpaid invoices beyond the specified payment date incur interest at the rate of 1.5% per month or the maximum allowable rate under applicable law.
- 3. Shipment; Delivery; Title and Risk of Loss.** All delivery dates are approximate. Seller is not responsible for damages resulting from any delay. Regardless of the manner of shipment, delivery occurs and title and risk of loss or damage pass to Buyer, upon placement of the Products with the shipment carrier at Seller's facility. Unless otherwise stated, Seller may exercise its judgment in choosing the carrier and means of delivery. No deferral of shipment at Buyers' request beyond the respective dates indicated will be made except on terms that will indemnify, defend and hold Seller harmless against all loss and additional expense. Buyer shall be responsible for any additional shipping charges incurred by Seller due to Buyer's acts or omissions.
- 4. Warranty.** Seller warrants that the Products sold hereunder shall be free from defects in material or workmanship for a period of twelve (12) months from the date of delivery or 2,000 hours of normal use, whichever occurs first. All prices are based upon the exclusive limited warranty stated above, and upon the following disclaimer: **DISCLAIMER OF WARRANTY: THIS WARRANTY IS THE SOLE AND ENTIRE WARRANTY PERTAINING TO PRODUCTS PROVIDED. SELLER DISCLAIMS ALL OTHER WARRANTIES, EXPRESS AND IMPLIED, INCLUDING DESIGN, MERCHANTABILITY AND FITNESS FOR A PARTICULAR PURPOSE.**
- 5. Claims; Commencement of Actions.** Buyer shall promptly inspect all Products upon receipt. No claims for shortages will be allowed unless reported to the Seller within ten (10) days of delivery. No other claims against Seller will be allowed unless asserted in writing within thirty (30) days after delivery. Buyer shall notify Seller of any alleged breach of warranty within thirty (30) days after the date the defect is or should have been discovered by Buyer. Any claim or action against Seller based upon breach of contract or any other theory, including tort, negligence, or otherwise must be commenced within twelve (12) months from the date of the alleged breach or other alleged event, without regard to the date of discovery.
- 6. LIMITATION OF LIABILITY.** IN THE EVENT OF A BREACH OF WARRANTY, SELLER WILL, AT ITS OPTION, REPAIR OR REPLACE A DEFECTIVE PRODUCT, OR REFUND THE PURCHASE PRICE WITHIN A REASONABLE PERIOD OF TIME. **IN NO EVENT IS SELLER LIABLE FOR ANY SPECIAL, INDIRECT, INCIDENTAL OR CONSEQUENTIAL DAMAGES ARISING OUT OF, OR AS THE RESULT OF, THE SALE, DELIVERY, NON-DELIVERY, SERVICING, USE OR LOSS OF USE OF THE PRODUCTS OR ANY PART THEREOF, OR FOR ANY CHARGES OR EXPENSES OF ANY NATURE INCURRED WITHOUT SELLER'S WRITTEN CONSENT, WHETHER BASED IN CONTRACT, TORT OR OTHER LEGAL THEORY. IN NO EVENT SHALL SELLER'S LIABILITY UNDER ANY CLAIM MADE BY BUYER EXCEED THE PURCHASE PRICE OF THE PRODUCTS.**
- 7. User Responsibility.** The user, through its own analysis and testing, is solely responsible for making the final selection of the system and Product and assuring that all performance, endurance, maintenance, safety and warning requirements of the application are met. The user must analyze all aspects of the application and follow applicable industry standards and Product information. If Seller provides Product or system options based upon data or specifications provided by the user, the user is responsible for determining that such data and specifications are suitable and sufficient for all applications and reasonably foreseeable uses of the Products or systems.
- 8. Loss to Buyer's Property.** Any designs, tools, patterns, materials, drawings, confidential information or equipment furnished by Buyer or any other items which become Buyer's property, will be considered obsolete and may be destroyed by Seller after two (2) consecutive years have elapsed without Buyer ordering the items manufactured using such property. Seller shall not be responsible for any loss or damage to such property while it is in Seller's possession or control.
- 9. Special Tooling.** A tooling change may be imposed for any special tooling, including without limitation, dies, fixtures, molds and patterns, acquired to manufacture Products. Such special tooling shall be and remain Seller's property notwithstanding payment of any charges by Buyer. In no event will Buyer acquire any interest in apparatus belonging to Seller which is utilized in the manufacture of the Products, even if such apparatus has been specially converted or adapted for such manufacture and notwithstanding any charges paid by Buyer. Unless otherwise agreed, Seller has the right to alter, discard or otherwise dispose of any special tooling or other property in its sole discretion at any time.
- 10. Buyer's Obligation; Rights of Seller.** To secure payment of all sums due or otherwise, Seller retains a security interest in all Products delivered to Buyer and this agreement is deemed to be a Security Agreement under the Uniform Commercial Code. Buyer authorizes Seller as its attorney to execute and file on Buyer's behalf all documents Seller deems necessary to perfect its security interest.
- 11. Improper Use and Indemnity.** Buyer shall indemnify, defend, and hold Seller harmless from any losses, claims, liabilities, damages, lawsuits, judgments and costs

- (including attorney fees and defense costs), whether for personal injury, property damage, patent, trademark or copyright infringement or any other claim, brought by or incurred by Buyer, Buyer's employees, or any other person, arising out of: (a) improper selection, application, design, specification or other misuse of Products purchased by Buyer from Seller; (b) any act or omission, negligent or otherwise, of Buyer; (c) Seller's use of patterns, plans, drawings, or specifications furnished by Buyer to manufacture Products; or (d) Buyer's failure to comply with these terms and conditions. Seller shall not indemnify Buyer under any circumstance except as otherwise provided.
- 12. Cancellations and Changes.** Buyer may not cancel or modify or cancel any order for any reason, except with Seller's written consent and upon terms that will indemnify, defend and hold Seller harmless against all direct, incidental and consequential loss or damage. Seller may change Product features, specifications, designs and availability.
- 13. Limitation on Assignment.** Buyer may not assign its rights or obligations under this agreement without the prior written consent of Seller.
- 14. Force Majeure.** Seller does not assume the risk and is not liable for delay or failure to perform any of Seller's obligations by reason of events or circumstances beyond its reasonable control (hereinafter "Events of Force Majeure"). Events of Force Majeure shall include without limitation: accidents, strikes or labor disputes, acts of any government or government agency, acts of nature, delays or failures in delivery from carriers or suppliers, shortages of materials, or any other cause beyond Seller's reasonable control.
- 15. Waiver and Severability.** Failure to enforce any provision of this agreement will not invalidate that provision; nor will any such failure prejudice Seller's right to enforce that provision in the future. Invalidation of any provision of this agreement by legislation or other rule of law shall not invalidate any other provision herein. The remaining provisions of this agreement will remain in full force and effect.
- 16. Termination.** Seller may terminate this agreement for any reason and at any time by giving Buyer thirty (30) days prior written notice. Seller may immediately terminate this agreement, in writing, if Buyer: (a) breaches any provision of this agreement (b) appoints a trustee, receiver or custodian for all or any part of Buyer's property (c) files a petition for relief in bankruptcy on its own behalf, or one if filed by a third party (d) makes an assignment for the benefit of creditors; or (e) dissolves its business or liquidates all or a majority of its assets.
- 17. Governing Law.** This agreement and the sale and delivery of all Products are deemed to have taken place in, and shall be governed and construed in accordance with, the laws of the State of Ohio, as applicable to contracts executed and wholly performed therein and without regard to conflicts of laws principles. Buyer irrevocably agrees and consents to the exclusive jurisdiction and venue of the courts of Cuyahoga County, Ohio with respect to any dispute, controversy or claim arising out of or relating to this agreement.
- 18. Indemnity for Infringement of Intellectual Property Rights.** Seller is not liable for infringement of any patents, trademarks, copyrights, trade dress, trade secrets or similar rights except as provided in this Section. Seller will defend and indemnify Buyer against allegations of infringement of U.S. patents, U.S. trademarks, copyrights, trade dress and trade secrets ("Intellectual Property Rights"). Seller will defend at its expense and will pay the cost of any settlement or damages awarded in an action brought against Buyer based on an allegation that a Product sold pursuant to this agreement infringes the Intellectual Property Rights of a third party. Seller's obligation to defend and indemnify Buyer is contingent on Buyer notifying Seller within ten (10) days after Buyer becomes aware of such allegations of infringement, and Seller having sole control over the defense of any allegations or actions including all negotiations for settlement or compromise. If a Product is subject to a claim that it infringes the Intellectual Property Rights of a third party, Seller may, at its sole expense and option, procure for Buyer the right to continue using the Product, replace or modify the Product so as to make it noninfringing, or offer to accept return of the Product and refund the purchase price less a reasonable allowance for depreciation. Notwithstanding the foregoing, Seller is not liable for claims of infringement based on information provided by Buyer, or directed to Products delivered hereunder for which the designs are specified in whole or part by Buyer, or infringements resulting from the modification, combination or use in a system of any Product sold hereunder. The foregoing provisions of this Section constitute Seller's sole and exclusive liability and Buyer's sole and exclusive remedy for infringement of Intellectual Property Rights.
- 19. Entire Agreement.** This agreement contains the entire agreement between the Buyer and Seller and constitutes the final, complete and exclusive expression of the terms of sale. All prior or contemporaneous written or oral agreements or negotiations with respect to the subject matter are herein merged. The terms contained herein may not be modified unless in writing and signed by an authorized representative of Seller.
- 20. Compliance with Laws.** Buyer agrees to comply with all applicable laws, regulations, and industry and professional standards of care, including those of the United Kingdom, the United States of America, and the country or countries in which Buyer may operate, including without limitation the U. K. Bribery Act, the U.S. Foreign Corrupt Practices Act ("FCPA"), the U.S. Anti-Kickback Act ("Anti-Kickback Act") and the U.S. Food Drug and Cosmetic Act ("FDCA"), each as currently amended, and the rules and regulations promulgated by the U.S. Food and Drug Administration ("FDA"), and agrees to indemnify and hold harmless Seller from the consequences of any violation of such provisions by Buyer, its employees or agents. Buyer acknowledges that it is familiar with the provisions of the U. K. Bribery Act, the FCPA, the FDA, and the Anti-Kickback Act, and certifies that Buyer will adhere to the requirements thereof. In particular, Buyer represents and agrees that Buyer will not make any payment or give anything of value, directly or indirectly to any governmental official, any foreign political party or official thereof, any candidate for foreign political office, or any commercial entity or person, for the purpose of influencing such person to purchase Products or otherwise benefit the business of Seller.



For inventory, lead time, and kit lookup, visit www.pdnplu.com

