

Parker Oil Seals Introduction

Catalog EPS 5350/USA

Contents

Engineering	6-2
Materials	6-5
Product Offering	6-9
Part Numbering	
Nomenclature	6-9
Parker Oil Seals	
Spring-Loaded Oil Retention Profiles	6-12
Springless Grease Retention Profiles	6-13
Dual Spring-Loaded Lip Profiles	6-14
Medium Pressure Profiles	6-15
Cassette Profiles	6-16
High Eccentricity Single Lip Profiles	6-17
Rotating Bore Profiles	6-18
PTFE/Elastomer Profiles	6-19
Wiper and Scraper Profiles	6-20



What makes Parker Oil Seals different?

Parker Oil Seals are backed with over 100 years of seal design experience. Available in the common metal OD construction for inch requirements and rubber covered OD for metric requirements. In addition to standard profiles, custom designs are available for O.E. and end user applications

Applications

Parker Oil Seal designs offer solutions to virtually any rotary sealing challenge. Along with seals that retain oil, grease and other viscous fluids, Parker offers seal designs to accommodate:

- High eccentricity
- Separation of two fluids
- Dry running
- High pressure
- Wiping and scraping

Also available are designs that exclude contaminants such as light dust, water splash, gravel and mud.

Parker Oil Seals can be found in:

- Gear Boxes
- Reducers
- Pumps
- Motors
- Custom Equipment
- Automotive Applications
- Appliances

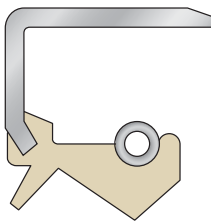

TB

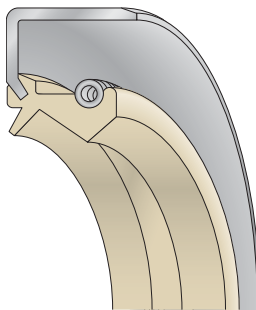

Parker Oil Seal

6

03/28/06



Shaft Recommendations

Material — Parker recommends a shaft material of carbon steel with a minimum hardness of Rockwell C30. Soft materials such as bronze, aluminum or plastic should be avoided because they are susceptible to grooving and will cause premature seal failure. If a soft shaft material must be used, a Parker Quick Sleeve or Parker Wear Sleeve can be installed over the soft shaft material to provide a durable sealing surface. See **Section 7** for details.

Shaft Finish — Parker recommends a plunge ground finish of 8 to 17 $\mu\text{in Ra}$ (0.20 to 0.43 $\mu\text{m Ra}$) with zero lead. Shaft finished significantly smoother or rougher will shorten the service life of the seal. For additional information on shaft finish refer to **Page 2-6**.

Shaft Profile — The shaft profile should include a lead-in chamfer per the following example (see **Table 2-2a** on **Page 2-8**). The leading edge helps prevent lip roll-back and spring dumping. The leading and trailing edges should be free of burrs and sharp edges that could cut the contact point of the seal lip.

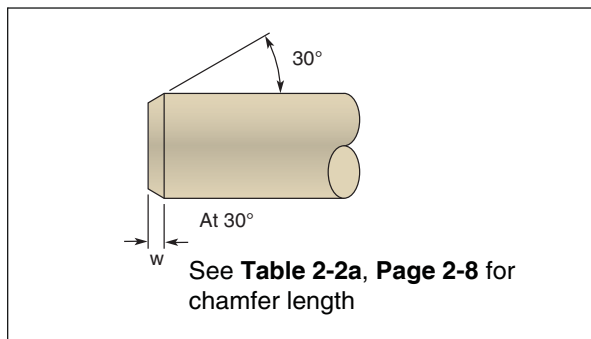

Figure 6-1. Shaft Profile

Shaft Tolerance — To ensure the proper lip-to-shaft interference is maintained, shaft diameters should fall within the tolerances specified in **Tables 6-1, 6-2** and **6-3**. Shafts significantly over the tolerance will increase the underlip temperatures and lead to premature failure. An undersized shaft compromises the amount of lip interference available to maintain a positive seal.

Housing Recommendations

Material — The most commonly used materials for seal housings are steel and cast iron. Care must be taken when softer materials such as aluminum, bronze or plastics are used for the housing material.

Housing Finish — A finish range of 40 to 100 $\mu\text{in Ra}$ (1.0 to 2.5 $\mu\text{m Ra}$) is recommended.

Housing Profile — A lead-in chamfer per the following example is highly recommended for all seal housings. The chamfer aligns the seal during installation and helps prevent the seal from cocking. Both corners of the chamfer should be free of burrs and sharp edges to minimize OD damage.

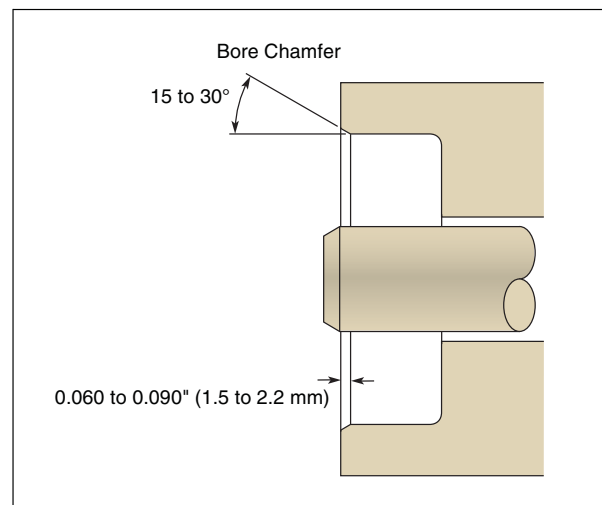

Figure 6-2. Housing Profile

Housing Tolerance — The diametrical tolerance of the housing for Parker Oil Seals should be within the limits specified on the next page.

03/28/06

Table 6-1. Shaft Tolerance

Inch		Metric			
Nominal Shaft Diameter	Shaft Tolerance	Nominal Shaft Diameter	Shaft Tolerance	Nominal Shaft Diameter	Shaft Tolerance
Up to 4.000"	±.003	6 to 10	+0.00 -0.09	250.01 to 315	+0.00 -0.32
		10.01 to 18	+0.00 -0.11	315.01 to 400	+0.00 -0.36
4.001 – 6.000"	±.004	18.01 to 30	+0.00 -0.13	400.01 to 500	+0.00 -0.40
		30.01 to 50	+0.00 -0.16	500.01 to 630	+0.00 -0.44
6.001 – 10.000"	±.005	50.01 to 80	+0.00 -0.19	630.01 to 800	+0.00 -0.50
		80.01 to 120	+0.00 -0.22	800.01 to 1000	+0.00 -0.56
Over 10.000"	±.006	120.01 to 180	+0.00 -0.25	1000.01 to 1250	+0.00 -0.66
		180.01 to 250	+0.00 -0.29	1250.01 to 1600	+0.00 -0.78

Table 6-2. Housing Tolerance for Inches

Nominal Bore Diameter	Bore Tolerance	Metal OD Seal			Rubber Covered OD Seal		
		Seal OD Tolerance	Nominal Press Fit		Seal OD Tolerance	Nominal Press Fit	
			Steel Bore	Aluminum Bore		Steel Bore	Aluminum Bore
Up to 2.000"	±.001"	±.002"	+0.005"	+0.006"	±.003"	+0.008"	+0.009"
2.001 – 3.000"	±.001"	±.0025"	+0.0055"	+0.008"	±.003"	+0.010"	+0.013"
3.001 – 4.000"	±.0015"	±.003"	+0.0065"	+0.010"	±.003"	+0.0105"	+0.014"
4.001 – 5.000"	±.0015"	±.003"	+0.0065"	+0.011"	±.003"	+0.0105"	+0.016"
5.001 – 7.000"	±.0015"	±.003"	+0.007"	+0.014"	±.004"	+0.012"	+0.020"
7.001 – 9.000"	±.002"	±.0035"	+0.0085"	Not Recommended	±.004"	+0.0125"	+0.023"
9.001 – 10.000"	±.002"	±.0035"	+0.0085"	Not Recommended	±.004"	+0.0125"	+0.023"



Table 6-3. Housing Tolerance for Metric

Nominal Bore Diameter	Bore Tolerance	Metal OD Seal		Rubber Covered OD Seal	
		Seal OD Tolerance		Seal OD Tolerance	
		Steel Bore	Aluminum Bore	Steel Bore	Aluminum Bore
Up to 50.00 mm	-0.00 +0.039	+0.20	+0.23	+0.30	+0.33
		+0.08	+0.11	+0.15	+0.18
50.01 – 80.00 mm	-0.00 +0.046	+0.23	+0.32	+0.35	+0.44
		+0.09	+0.18	+0.20	+0.29
80.01 – 120.00 mm	-0.00 +0.054	+0.25	+0.36	+0.35	+0.49
		+0.10	+0.21	+0.20	+0.34
120.01 – 180.00 mm	-0.00 +0.063	+0.28	+0.46	+0.45	+0.65
		+0.12	+0.30	+0.25	+0.45
180.01 – 250.00 mm	-0.00 +0.072	+0.35	Not Recommended	+0.45	+0.72
		+0.15		+0.25	+0.52

03/28/06



Parker Oil Seal Installation

1. Clean seal bore and shaft and remove all burrs and nicks.
2. Pre-lubricate the seal ID and shaft before installing the seal into the cavity. Use a pre-lube that is compatible with the system lubricant. The pre-lube will make the seal easier to install and prevent dry running during initial start-up.
3. Protect seal lip against damage from sharp keyways, splines and screw threads. This can be done by either taping the keyway, inserting an element into the keyway or using an assembly sleeve that fits over the shaft.
4. Point seal lip in correct direction and push to edge of the counterbore.

5. Slide the seal over the shaft to the seal housing. With finger pressure, start seal into housing with a slight rotating motion until seal has a light press fit in the housing. Be sure seal is square or perpendicular to the shaft. If the seal is crooked or cocked, continuing with installation will damage the seal.

6. Finish installation by using a tool appropriate for your seal/housing configuration. Drive seal to final position. If using a plate, the plate diameter should be large enough so it contacts the face of seal housing. This will ensure seal is positioned straight and perpendicular to the shaft.

6

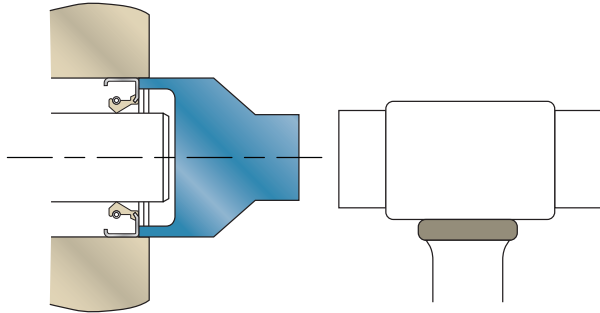

Through bore — Installation tool bottoms on shaft face

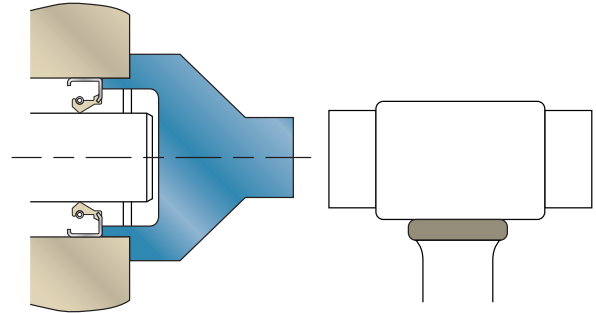

Through bore — Installation tool bottoms on machined housing face

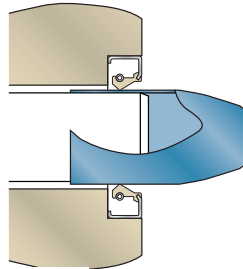

Coned assembly sleeve

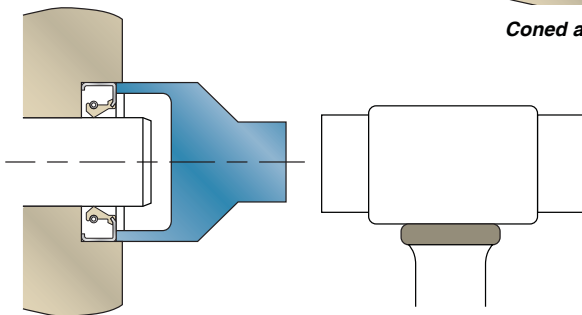

Stepped bore — Seal bottoms on machined bore shoulder

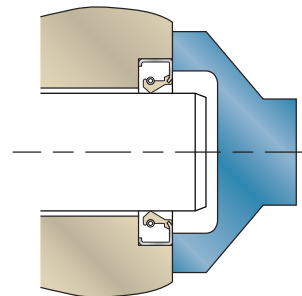

Stepped bore — Seal flush with bore face

03/28/06

Parker Oil Seals Materials

Catalog EPS 5350/USA

Common Materials Used in this Product

Parker Oil Seals are available in a wide range of materials. The following general material descriptions are for the lip material.

N — Nitrile (NBR)

Standard Nitrile is the most commonly used polymer in the rotary shaft seal industry. NBR has very good resistance to oil, fuel and alkali solutions. Nitrile offers excellent resistance to petroleum-based hydraulic fluids and is resistant to hydrocarbon solvents. Standard Nitrile has poor resistance to ozone, ketones, automotive or aircraft brake fluid, and steam or hot water. Standard Nitrile is recommended for operating in temperatures ranging from -20 to +250 °F (-29 to +121 °C) and offers good mechanical properties and abrasion resistance.

L40, L55 — Low Temp Nitrile (NBR)

Nitrile compounds can be formulated for applications in extreme cold weather environments. These special formulations of Nitrile allow for operation at minimum temperatures ranging down to -70 °F (-57 °C), while maintaining good chemical and abrasion resistance, but the upper temperature limit is lowered to 212 °F (100 °C).

X — Carboxylated Nitrile (XNBR)

XNBR is formulated to greatly enhance tear and abrasion resistance over standard Nitrile, while maintaining similar chemical compatibility. It is used in applications where abrasive materials may collect at the point of shaft contact. XNBR is less resilient and flexible at low temperature, and offers poorer compression set resistance than standard Nitrile. Carboxylated Nitriles are recommended for operation at temperatures ranging from -30 to +250 °F (-34 to +121°C).

H — Hydrogenated Nitrile (HNBR)

Hydrogenated Nitriles offer improved abrasion resistance, excellent chemical resistance and higher operating temperatures than standard NBR. Ozone and weather resistance, as well as resistance to hot water are also increased. HNBR compounds are recommended for operating temperatures ranging from -40 to +300 °F (-40 to +149 °C).

V — Fluoroelastomer (FKM)

FKM provides excellent resistance to oils, fuels and hydraulic fluids at temperatures that far exceed standard Nitrile. It also has very good resistance to flame and excellent impermeability to gases and vapors. FKM is recommended for operating temperatures that range from -40 to +400 °F (-40 to +204 °C).

03/28/06



T — PTFE (T)

Polytetrafluoroethylene is recommended for use with virtually any fluid. Extremely low friction, high temperature tolerance, and dry running capabilities are other advantages of PTFE materials. Excellent mechanical properties are achieved when PTFE is used with fillers such as glass, bronze, carbon fiber, mineral and others. Parker EPS has over 300 compounds to cover virtually all application requirements. Parker can bond PTFE to rubber for enhanced performance.

S — Silicone (VMQ)

Generally recommended for high temperature, low friction applications. Silicone is resistant to weather, ozone, water, bases and alcohols. Not recommended in applications where steam, acids, aliphatic hydrocarbons, aromatic hydrocarbons, halogenated hydrocarbons, phosphate ester or polar solvents are present. It has poor abrasion resistance. Recommended for operating temperatures ranging from -90 to +400 °F (-67 to +204 °C).

C — Neoprene (CR)

Neoprene offers very good resistance to weather, ozone and natural aging as well as good flame resistance while maintaining moderate resistance to oil and gasoline. Good abrasion, flex and cracking resistance is available with the Neoprene material. Neoprene is recommended for operating temperatures ranging from -45 to +250 °F (-43 to +121 °C).

P — Polyacrylate (ACM)

Polyacrylate elastomers are most often recommended for higher operating temperatures or applications where extreme pressure lubricants are used. This material also offers additional resistance over standard Nitrile to ozone and weather attack. Recommended for operating temperatures ranging between -13 to +302 °F (-25 to +150 °C).

E — Ethylene Propylene (EPDM)

EPDM offers excellent heat, ozone and sunlight resistance. EPDM offers very good low temperature flexibility, good resistance to alkalis, acids (such as acetic), and oxygenated solvents (such as MEK). Provides improved resistance to water and steam in applications where NBR and FKM exhibit poor service life. Good replacement for FKM where solvents are a problem. It is not recommended for petroleum oil. EPDM is recommended for operating temperatures of -60 to +300 °F (-51 to +149°C).

EA — Ethylene Acrylic (AEM)

Ethylene Acrylic is generally recommended for low temperature transmission applications. It has good dry running capabilities and good abrasion resistance. Recommended for operating temperatures ranging from -40 to +350 °F (-40 to +177 °C).

03/28/06

Parker Oil Seals





Case Code (B, A, P) — Metal Case

Cold rolled carbon steel is the most common and cost-effective metal case material. Cases are treated to resist corrosion during normal handling and storage. Stainless steel case materials are available at additional cost for use in corrosive applications and extreme conditions. A front chamfer and ParKote™ polymer coating on the OD of the metal case is standard. ParKote™ coating fills small imperfections in the bore. A ground OD is also available.

Case Code (C, M, D) — Rubber Covered

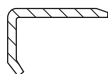
Case material can be partially or completely coated in rubber. Generally, carbon steel cases are used in rubber covered profiles. Rubber covered OD can ease installation and improve bore sealability.

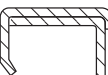
Table 6-4. Case Profiles/Materials

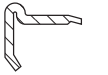
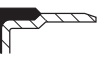
Application	Description	Profile
Most common and economical. ParKote™ coating is standard.	"L" Case	B 
Improved OD sealing in bores with minor imperfections and in soft alloy housings.	Rubber Covered Case	C 
Inner case provides structural rigidity for large cross-sections. ParKote™ coating is standard. Guides shaft during installation.	Double Case	A 
Protects metal case from internal corrosion.	Rubber Lined Case	M 
Ease of removal. Positioning Flange.	"P" Case	P 
Reduced spring back. Ease of installation. Combines sealability of rubber OD and metal retention of metal OD	Heel Case	D 

Spring Materials

Springs are available in a wide range of materials. Parker Oil Seal designs are furnished with carbon steel springs as standard. Other spring materials are available at an additional cost. **Table 6-5** shows general operating parameters for the most common spring materials.

Table 6-5. Spring Material Parameters

Wire Type	Maximum Service Temperature		Application
	°C	°F	
Carbon Steel	120	250	General purpose
Monel 400	230	450	Saltwater
Inconel 750	675	1250	Extreme temperature
Phosphor Bronze	95	200	Saltwater
302/304 Stainless Steel	260	500	Corrosion resistance
316 Stainless Steel	315	600	Hi-temp corrosion resistance
Hastelloy®	315	600	Hi-temp



Table 6-6. Parker Oil Seal Standard Material

Lip Matl. Code	Material Description	Abrasion Resistance	Min. Temp	Cont. Temp	Peak. Temp
N	Nitrile (NBR) Standard NBR offering. The NBR lip material has very good resistance to oil and gasoline. Superior resistance to petroleum based hydraulic fluids. Good resistance to hydrocarbon solvents. Very good resistance to alkalis and solvents. Poor resistance to oxygenated solvents.	Very Good	-20 °F -29 °C	212 °F 100 °C	250 °F 121 °C
X	Carboxylated Nitrile (XNBR) The XNBR lip material is generally tougher and more resistant to tear and abrasion than standard NBR.	Outstanding	-30 °F -34 °C	212 °F 100 °C	250 °F 121 °C
H	Hydrogenated Nitrile (HNBR) The HNBR lip material offers improved abrasion resistance, chemical resistance, higher operating temperature and better ozone resistance than standard NBR.	Outstanding	-40 °F -40 °C	250 °F 121 °C	300 °F 149 °C
L40	Low Temp (NBR) Low temperature Nitrile lip material allows for lower minimum operating temperatures while providing good chemical and abrasion resistance.	Very Good	-40 °F -40 °C	200 °F 93 °C	212 °F 100 °C
L55	Low Temp (NBR) Same characteristics as L40, with lower minimum temperature.	Very Good	-67 °F -55 °C	200 °F 93 °C	212 °F 100 °C
V	Fluoroelastomer (FKM) FKM lip material offers outstanding resistance to high heat. Excellent resistance to oil, gasoline, petroleum hydraulic fluids and hydrocarbon solvents. Very good impermeability to gases and vapors. Very good resistance to flame, weather, oxygen, ozone and sunlight. Very little resistance to oxygenated solvents. Poor tear resistance.	Good	-40 °F -40 °C	325 °F 163 °C	400 °F 204 °C
E	Ethylene Propylene (EPDM) Excellent heat, ozone and sunlight resistance. Very good low temperature flexibility, good resistance to alkalis, acids (such as acetic) and oxygenated solvents (such as MEK). Provides improved resistance to water and steam in applications where NBR and FKM exhibit poor service life. Good replacement for FKM where solvents are a problem. Not recommended for petroleum oil.	Very Good	-60 °F -51 °C	250 °F 121 °C	300 °F 149 °C
S	Silicone (VMQ) Generally recommended for high temperature, low friction applications. Silicone is resistant to weather, ozone, water, bases and alcohols. Not recommended in applications where steam, acids, aliphatic hydrocarbons, aromatic hydrocarbons, halogenated hydrocarbons, phosphate ester or polar solvents are present.	Poor	-90 °F -67 °C	325 °F 163 °C	400 °F 204 °C
CR	Neoprene (CR) Very good resistance to weather, ozone and natural aging as well as good flame resistance while maintaining moderate resistance to oil and gasoline. Good abrasion, flex and cracking resistance is available with the Neoprene material	Very Good	-45 °F -43 °C	212 °F 100 °C	250 °F 121 °C
P	Polyacrylate (ACM) Most often recommended for higher operating temperatures or applications where extreme pressure (EP) lubricants are used. This material also offers additional resistance over standard Nitrile to ozone and weather attack.	Good	-13 °F -25 °C	260 °F 127 °C	302 °F 150 °C
EA	Ethylene Acrylic (AEM) Generally recommended for lower temperature transmission applications. Good dry running capabilities. Good compatibility to ATF fluids. Increased swelling properties over NBR, ACM and FKM.	Good	-40 °F -40 °C	325 °F 163 °C	350 °F 176 °C

03/28/06

Parker Oil Seals Product Offering

Catalog EPS 5350/USA

Part Number Nomenclature — Parker Oil Seals

English

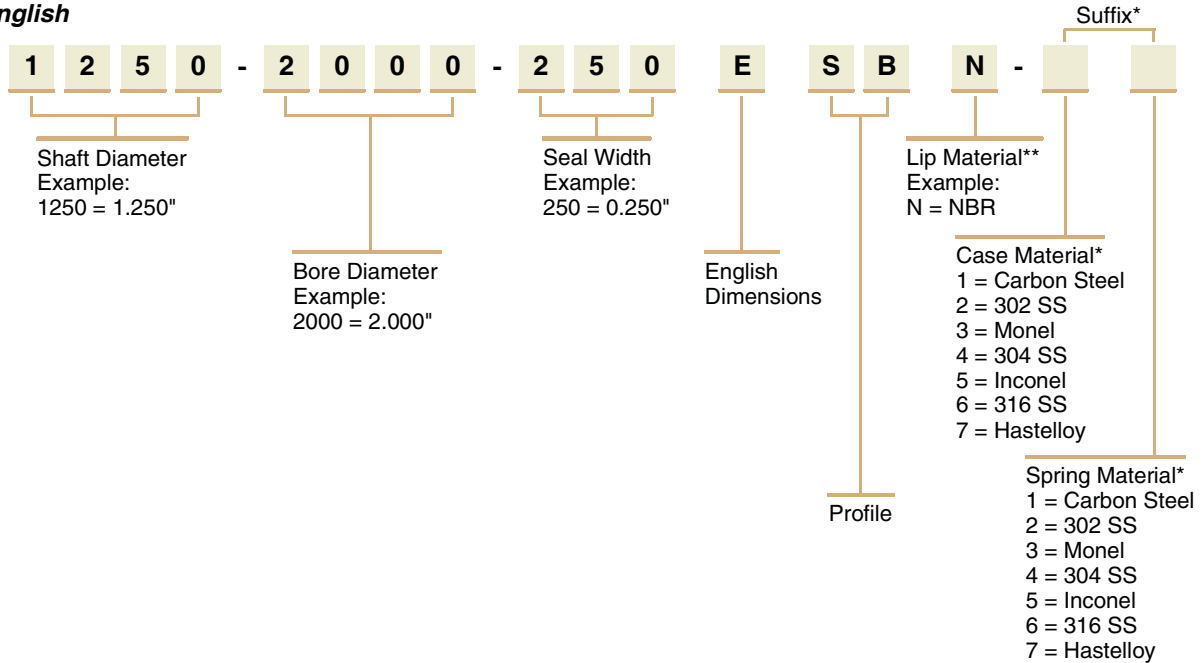

Metric

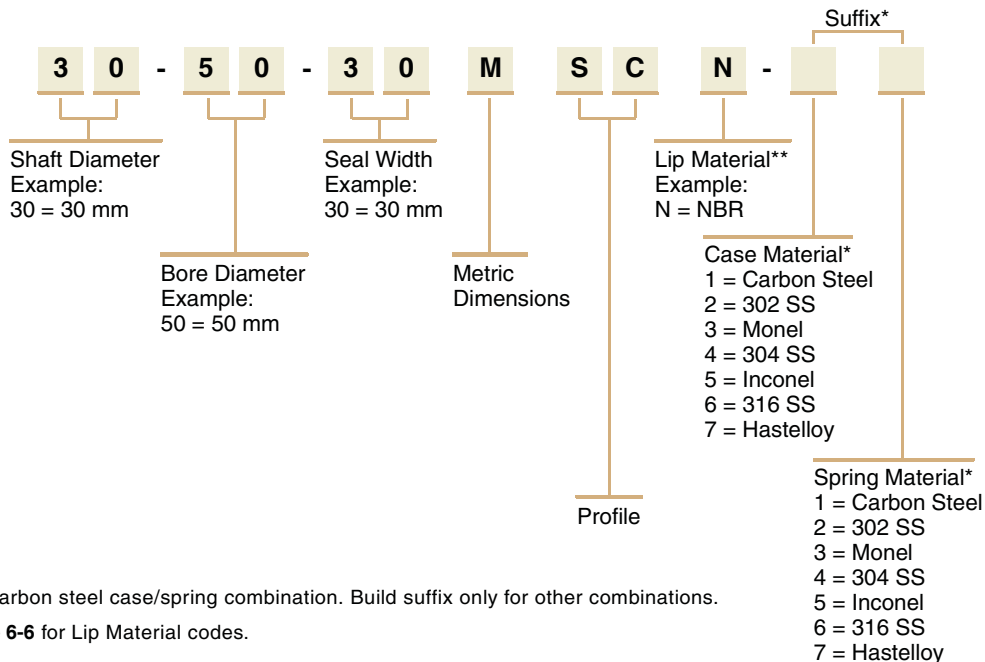

* Blank = Carbon steel case/spring combination. Build suffix only for other combinations.







































** See Table 6-6 for Lip Material codes.

03/28/06



Profiles

Table 6-7. Product Profiles

Standard Profiles	Other Profiles Available				Features	Applications	
SB 	SC 	SA 	SM 	SD 	General purpose. Spring-loaded single lip. For oil retention or grease retention.	Electric motors, gearboxes, pumps, fans and rolling mills.	
TB 	TC 	TA 	TM 	TD 	General purpose. Spring-loaded double lip. For oil retention. Excludes light dust and fluid.	Electric motors, gearboxes, pumps, fans, rolling mills and custom equipment.	
SCE 	SAE 	SME 			Spring-loaded single lip. For oil or grease retention. Low speeds.	High runout conditions. Electric motors, gearboxes, pumps, fans, rolling mills.	
KB 	KC 	KA 	KM 			General purpose. Double lip springless design. For grease retention. Excludes light dust and fluid.	Electric motors, gearboxes, pumps and fans.
VB 	VC 	VA 	VM 			General purpose. Springless single lip. For grease retention.	Electric motors, gearboxes, pumps and fans.
OSB 	OSC 	OSA 			Outside lip design. Spring-loaded single lip. For rotating bores. Press fit on shaft.	Electric motors, gearboxes, pumps and fans. For grease applications where bore rotates.	
W 					General purpose rod wiper. For rotary and reciprocating service. Springless single lip. For dust exclusion.	Low retention, dust exclusion or scraper for reciprocating shafts.	
TDN3 	NSC4 	NTC4 			Pressures to 200 psi (13.7 bar) depending on design. FKM material often used for high temperatures normally associated with friction caused by pressure.	Pumps, washers, compressors and blowers.	
DB 	DC 				Dual spring-loaded lips.	Used when the separation of two fluids is required. The design is also used for high contamination applications in keeping out a dirty environment.	
SBF 	SCF 	TBF 	TCF 			Specially designed seals that utilize a layer of PTFE bonded to the sealing lip to reduce excessive wearing on the shaft and seal.	With the PTFE lip, the seal can be utilized in dry running applications, at higher speeds and accepts a broader range of chemical compatibility.
TN 					The TN lip element is PTFE bonded to NBR and combines the low friction properties of PTFE with the flexibility of rubber.	The TN seal was specially developed for severe service applications.	
CB 	CL (Low Speed) 	CH (High Speed) 			One-piece unitized designs. The sealing elements ride on a proper internal sealing surface which offers the advantage of eliminating the cost of preparing or resurfacing the shaft.	Reducers, gearboxes and torque hubs.	

03/28/06

Operating Temperature Range	Shaft Surface Speed fpm (m/s)	Shaft Size Range Inches (mm)	Maximum Shaft Dynamic Runout (TIR)	Maximum (STBM) Misalignment	Maximum Pressure psi (bar)	Page
NBR -20 °F to 250 °F -29 °C to 121 °C FKM -40 °F to 400 °F -40 °C to 204 °C	Up to 3200 (16.3)	1/4 – 10 (5 – 260)	0.010" (0.254 mm)	0.010" (0.254 mm)	0 – 7 (0 – 0.48) <i>Depending on Shaft Speed</i>	6-12
NBR -20 °F to 250 °F -29 °C to 121 °C FKM -40 °F to 400 °F -40 °C to 204 °C	Up to 2500 (12.7)	1/4 – 10 (5 – 260)	0.010" (0.25 mm)	0.010" (0.25 mm)	0 – 7 (0 – 0.48) <i>Depending on Shaft Speed</i>	6-12
NBR -20 °F to 250 °F -29 °C to 121 °C FKM -40 °F to 400vF -40 °C to 204 °C	Up to 2500 (12.7) <i>Speed Depends on Runout</i>	3/4 – 10 (20 – 260)	0.020" – 0.125" (0.51 – 3.18 mm)	0.020 – 0.125" (0.51 – 3.18 mm)	0 – 3 (0 – 0.20) <i>Depending on Shaft Speed</i>	6-17
NBR -20 °F to 250 °F -29 °C to 121 °C FKM -40 °F to 400 °F -40 °C to 204 °C	Up to 2000 (10.2)	1/4 – 10 (5 – 260)	0.010" (0.254 mm)	0.010" (0.254 mm)	0 – 7 (0 – 0.48) <i>Depending on Shaft Speed</i>	6-13
NBR -20 °F to 250 °F -29 °C to 121 °C FKM -40 °F to 400 °F -40 °C to 204 °C	Up to 2000 (10.2)	1/4 – 6 (5 – 150)	0.010" (0.254 mm)	0.010" (0.254 mm)	0 – 7 (0 – 0.48) <i>Depending on Shaft Speed</i>	6-13
NBR -20 °F to 250 °F -29 °C to 121 °C FKM -40 °F to 400 °F -40 °C to 204 °C	Up to 1000 (5.1)	1/4 – 10 (5 – 260)	0.010" (0.254 mm)	0.010" (0.254 mm)	0 – 7 (0 – 0.48) <i>Depending on Shaft Speed</i>	6-18
NBR -20 °F to 250 °F -29 °C to 121 °C FKM -40 °F to 400 °F -40 °C to 204 °C	Rotary: Up to 2000 (10.2) Reciprocating: Up to 300 (1.5)	3/8 – 10 (10 – 250)	0.010" (0.254 mm)	0.008" (0.20 mm)	0	6-20
NBR -20 °F to 250 °F -29 °C to 121 °C FKM -40 °F to 400 °F -40 °C to 204 °C	Up to 4000 (20.3)	1/4 – 4 (5 – 100)	0.005" (0.127 mm)	0.005" (0.127 mm)	200 (13.7) <i>Depending on Shaft Speed</i>	6-15
NBR -20 °F to 250 °F -29 °C to 121 °C FKM -40 °F to 400 °F -40 °C to 204 °C	Up to 2000 (10.2)	1/4 – 4 (5 – 100)	0.010" (0.254 mm)	0.010" (0.254 mm)	0 – 7 (0 – 0.48) <i>Depending on Shaft Speed</i>	6-14
NBR -20 °F to 250 °F -29 °C to 121 °C FKM -40 °F to 400 °F -40 °C to 204 °C	Up to 5000 (25.4)	1/2 – 10 (10 – 250)	0.010" (0.254 mm)	0.010" (0.254 mm)	0 – 7 (0 – 0.68) <i>Depending on Shaft Speed</i>	6-19
NBR -20 °F to 250 °F -29 °C to 121 °C FKM -40 °F to 400 °F -40 °C to 204 °C	Up to 2500 (12.7)	3/8 – 6 (9.5 – 152)	0.006" (0.15 mm)	0.010" (0.254 mm)	0 – 10 (0.68) <i>Depending on Shaft Speed</i>	6-19
NBR -20 °F to 250 °F -29 °C to 121 °C FKM -40 °F to 400 °F -40 °C to 204 °C	Up to 3200 (16.3)	1/2 – 14 (10 – 350)	0.010" (0.254 mm)	0.010" (0.254 mm)	0 – 7 (0 – 0.48) <i>Depending on Shaft Speed</i>	6-16



03/28/06



Parker Oil Seals

Spring-Loaded Oil Retention Profiles

Catalog EPS 5350/USA

Spring-Loaded Oil Retention Profiles

TB, SB — Metal case with ParKote™ bore sealant or ground OD. Most common and economical.

TC, SC — Rubber covered OD for improved OD sealing and soft alloy housing.

TA, SA — Double case with ParKote™ bore sealant or ground OD. Structural rigidity, blind shaft installation.

Application

General purpose, spring-loaded design. Most commonly used for oil or grease retention. Double lip profiles have secondary lip for light dust and fluid exclusion.

Technical Data

Operating Temperature Range

NBR: -20 to 250 °F (-29 to 121 °C)
FKM: -40 to 400 °F (-40 to 204 °C)

Shaft Surface Speed

TB, TC, TA — Up to 2500 fpm (12.7 m/s)
SB, SC, SA — Up to 3200 fpm (16.3 m/s)

Maximum Pressure

0 to 7 psi (0 to 0.48 bar), depending on shaft speed

Shaft Size Range

0.250 to 10.000 inches (5 to 260 mm)

Important: For full listings of standard sizes, see **Appendices B and C**.

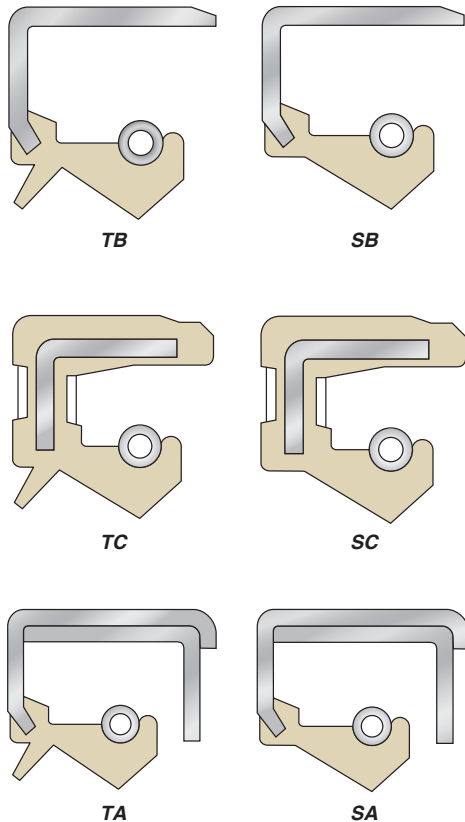

For additional case profiles/materials options, see **Page 6-7**.

03/28/06

Parker Oil Seals

Springless Grease Retention Profiles

Catalog EPS 5350/USA

Springless Grease Retention Profiles

KB, VB — Metal case with ParKote™ bore sealant or ground OD. Most common and economical.

KC, VC — Rubber covered OD. Improved OD sealing and soft alloy housing.

KA, VA — Double case with ParKote™ bore sealant or ground OD. Structural rigidity, blind shaft installation.

Application

General purpose, springless design. Most commonly used for grease retention. Double lip profiles incorporate a secondary lip for exclusion of light dust and fluids.

6

Technical Data

Operating Temperature Range

NBR: -20 to 250 °F (-29 to 121 °C)
FKM: -40 to 400 °F (-40 to 204 °C)

Shaft Surface Speed

Up to 2000 fpm (10.2 m/s)

Maximum Pressure

0 to 7 psi (0 to 0.48 bar), depending on shaft speed

Shaft Size Range

0.250 to 6.000 inches (5 to 150 mm)

Important: For full listings of standard sizes, see **Appendices B and C**.

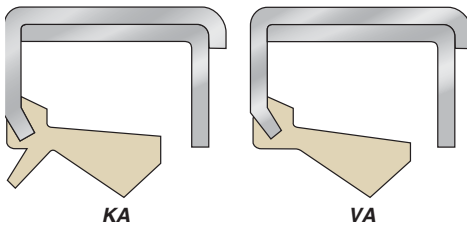
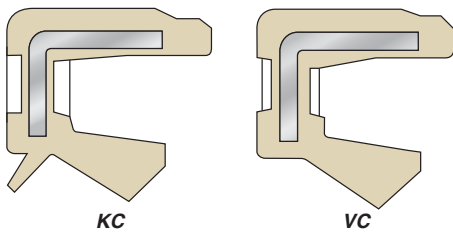
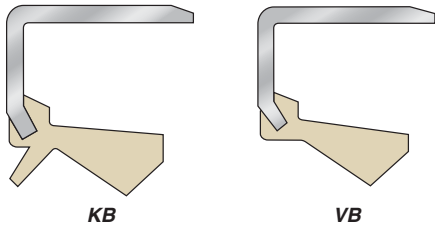

For additional case profiles/materials options, see **Page 6-7**.

03/28/06

Parker Oil Seals

Dual Spring-Loaded Lip Profiles

Catalog EPS 5350/USA

Dual Spring-Loaded Lip Profiles

DB — Metal case with ParKote™ bore sealant or ground OD. Most common and economical.

DC — Rubber covered OD for improved OD sealing and soft alloy housing.

DA — Assembled case with ParKote™ bore sealant or ground OD. Structural rigidity, blind shaft installation.

Application

Dual spring-loaded lips are generally used where separation of two fluids is required. Also used for high contamination applications.

Technical Data

Operating Temperature Range

NBR: -20 to 250 °F (-29 to 121 °C)

FKM: -40 to 400 °F (-40 to 204 °C)

Shaft Surface Speed

Up to 2000 fpm (10.2 m/s)

Maximum Pressure

0 to 7 psi (0 to 0.48 bar), depending on shaft speed

Shaft Size Range

0.250 to 4.000 inches (5 to 100 mm)

Important: Contact customer service for available sizes.

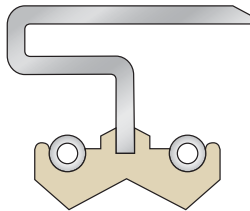

DB

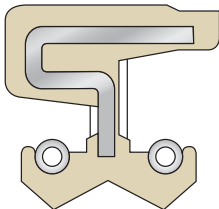

DC

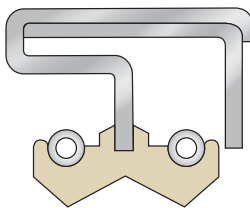

DA

6

03/28/06

Parker Oil Seals

Medium Pressure Profiles

Catalog EPS 5350/USA

Medium Pressure Profiles

TDN3 — Rubber covered OD for improved OD sealing and secondary lip for light dust exclusion.

NSC4 — Rubber covered OD for improved OD sealing.

NTC4 — Rubber covered OD for improved OD sealing and secondary lip for light dust exclusion.

Application

For medium pressure applications.

Technical Data

Operating Temperature Range

NBR: -20F to 250 °F (-29 to 121 °C)

FKM: -40 to 400 °F (-40 to 204 °C)

Shaft Surface Speed

Thru 4000 fpm (20.3 m/s)

Maximum Pressure

Up to 200 psi (13.7 bar), depending on design and shaft speed

Shaft Size Range

0.250 to 4.000 inches (5 to 100 mm)

Important: Contact customer service for available sizes.

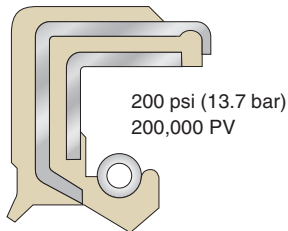

TDN3

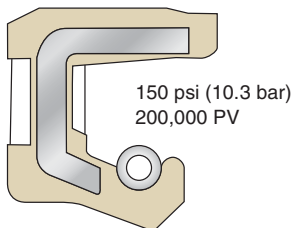

NSC4

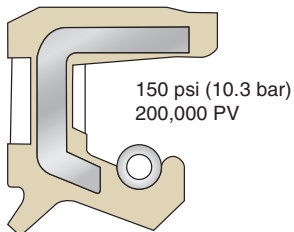

NTC4

6

03/28/06

Parker Oil Seals Cassette Profiles

Catalog EPS 5350/USA

6

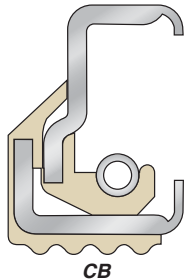

CB

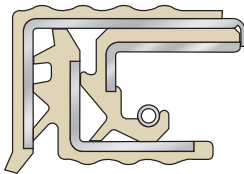

CL
(Low Speed)

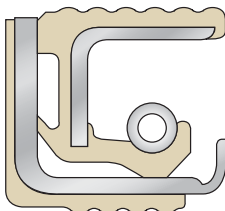

CH
(High Speed)

Cassette Profiles

CB — Metal case with ParKote™ bore sealant standard. CB design requires special installation tool.

CL, CH — Rubber covered OD for improved OD sealing and soft alloy housing.

Application

Unitized design. Sealing elements ride on a proper internal sealing surface. Primarily used in gear box applications. Improved contaminant exclusion. Minimizes shaft surfacing requirements and will not groove shaft.

Technical Data

Operating Temperature Range

NBR: -20 to 250 °F (-29 to 121 °C)

FKM: -40 to 400 °F (-40 to 204 °C)

Shaft Surface Speed

Up to 3200 fpm (16.3 m/s) depending on design

Maximum Pressure

0 to 7 psi (0 to 0.48 bar), depending on shaft speed

Shaft Size Range

0.500 to 14.000 inches (10 to 350 mm)

Important: Contact customer service for available sizes.

03/28/06

Parker Oil Seals

High Eccentricity Single Lip Profiles

Catalog EPS 5350/USA

High Eccentricity Single Lip Profiles

SCE — Rubber covered OD for improved OD sealing in bores with minor imperfections and soft alloy housing.

SME — Metal case OD with rubber inside providing corrosion protection for inside of case.

SAE — Double case with ParKote™ bore sealant standard. Inner case provides structural rigidity for large cross-sections. Guides shaft during installation.

Application

Seal lip floats with shaft for more uniform lip loading during misalignment conditions. High runout conditions, up to 0.125 inch (3.18 mm) total eccentricity for oil or grease retention. Moderate speeds, dependent on misalignment.

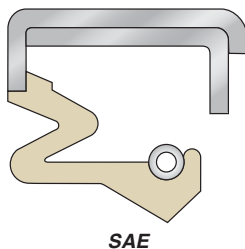
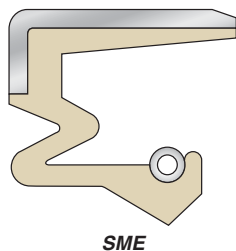
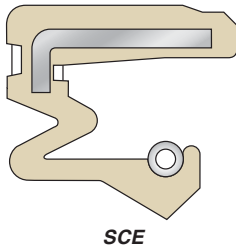

Technical Data

Operating Temperature Range

NBR: -20 to 250 °F (-29 to 121 °C)
FKM: -40 to 400 °F (-40 to 204 °C)

Shaft Surface Speed

Up to 2500 fpm (12.7 m/s) depending on runout

Maximum Pressure

0 to 3 psi (0.20 bar), depending on shaft speed

Shaft Size Range

0.750 to 10.000 inches (20 to 260 mm)

Important: Contact customer service for available sizes.

6

03/28/06

Parker Oil Seals

Rotating Bore Profiles

Catalog EPS 5350/USA

Rotating Bore Profiles

OSB — Metal case with press fit ID.

OSC — Rubber covered ID for improved ID sealing.

OSA — Double case for structural rigidity.

Application

Outside spring-loaded single lip design. For grease applications where bore rotates.

Technical Data

Operating Temperature Range

NBR: -20 to 250 °F (-29 to 121 °C)

FKM: -40 to 400 °F (-40 to 204 °C)

Surface Speed

Up to 1000 fpm (5.1 m/s)

Maximum Pressure

0 to 7 psi (0 to 0.48 bar), depending on speed

Shaft Size Range

0.250 to 10.000 inches (5 to 260 mm)

Important: Contact customer service for available sizes.

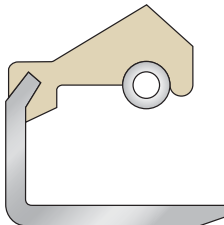

OSB

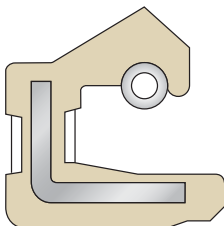

OSC

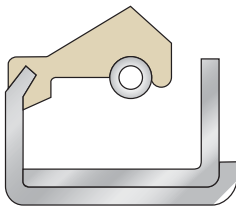

OSA

6

03/28/06

Parker Oil Seals

PTFE/Elastomer Profiles

Catalog EPS 5350/USA

PTFE/Elastomer Profiles

SBF — Metal case with ParKote™ bore sealant standard. Most common and economical.

SCF — Rubber covered OD for improved OD sealing in bores with minor imperfections and soft alloy housing.

TBF — Metal case with ParKote™ bore sealant standard. Most common and economical.

TCF — Rubber covered OD for improved OD sealing in bores with minor imperfections and soft alloy housing.

TN — The TN lip element is PTFE bonded to NBR and combines the low friction properties of PTFE with the flexibility of rubber.

Application

The lip element is PTFE bonded to rubber and combines the low friction properties of PTFE with the flexibility of rubber. For dry running applications, higher speeds and enhanced chemical compatibility.

Technical Data

Operating Temperature Range

NBR: -20 to 250 °F (-29 to 121 °C)
FKM: -40 to 400 °F (-40 to 204 °C)

Shaft Surface Speed

Up to 5000 fpm (25.4 m/s)
(TN — up to 2500 fpm [12.7 m/s])

Maximum Pressure

0 to 7 psi (0 to 0.48 bar), depending on shaft speed
(TN — up to 10 psi [0.68 bar])

Shaft Size Range

0.500 to 10.000 inches (10 to 250 mm)

Important: Contact customer service for available sizes.

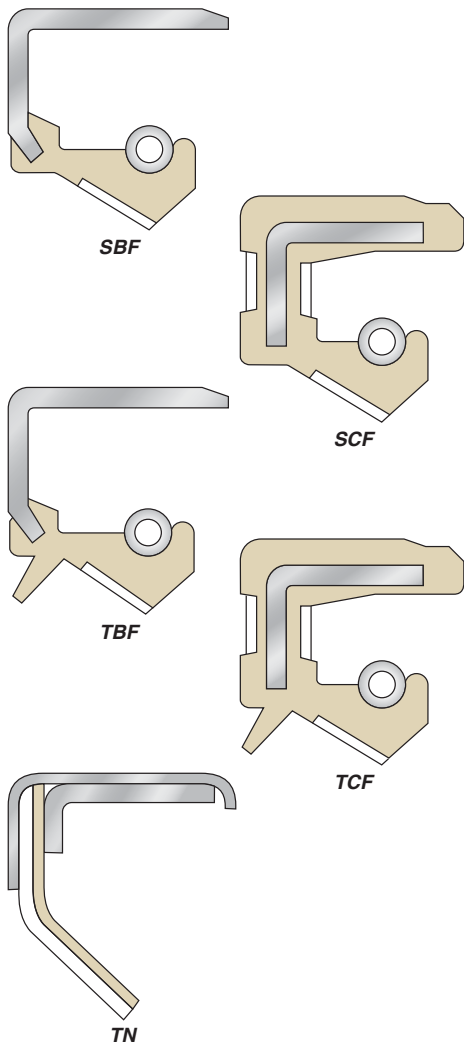

6

03/28/06

Parker Oil Seals

Wiper and Scraper Profiles

Catalog EPS 5350/USA

Wiper and Scraper Profiles

W — Metal case with ParKote™ bore sealant or ground OD. Scraper lip profile.

WPC — Rubber covered OD for improved OD sealing. Wiper profile for grease retention in slow rotary and reciprocating applications.

WPR — Rubber covered OD for improved OD sealing. Scraper lip profile.

Application

General purpose rod wiper. For rotary and reciprocating shafts. Single lip, springless design. For heavy dust exclusion.

Technical Data

Operating Temperature Range

NBR: -20 to 250 °F (-29 to 121 °C)

FKM: -40 to 400 °F (-40 to 204 °C)

Shaft Surface Speed

Up to 2000 fpm (10.2 m/s) Rotary

Up to 300 fpm (1.5 m/s) Reciprocating

Maximum Pressure

0

Shaft Size Range

0.375 to 10.000 inches (10 to 250 mm)

Important: Contact customer service for available sizes.

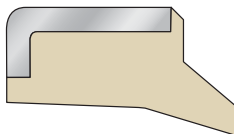

W

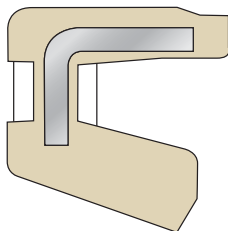

WPC

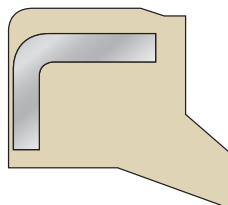

WPR

6

03/28/06