

Contents

Solenoid Valves

CV Check Valves

SH Shuttle Valves

LM Load/Motor Controls

FC Flow Controls

PC Pressure Controls

LE Logic Elements

DC Directional Controls

MV Manual Valves

SV Solenoid Valves

PV Proportional Valves

CE Coils & Electronics

BC Bodies & Cavities

TD Technical Data

SERIES	CAVITY	DESCRIPTION	FLOW LPM/GPM	PRESSURE BAR/PSI	PAGE NO.
HIGH FLOW VALVE FAMILY					
<i>See individual catalog pages for exact specifications.</i>					
2 WAY SPOOL TYPE					
		GS02 22* 2X / C09-2 .. 2 Position, 2 Way, N.C. Spool	19/5	350/5000	SV7-SV8
		GS02 27* 2X / C09-2 .. 2 Position, 2 Way, N.O. Spool	19/5	350/5000	SV9-SV10
<i>*These valves fit the C09-2 Parker cavity.</i>					
4 WAY, 2 POSITION SPOOL TYPE					
		GS02 42 C08-4 2 Position, 4 Way	19/5	350/5000	SV11-SV12
2 WAY POPPET TYPE					
	☆	DSL081 C08-2 2 Position, 2 Way, N.C. or N.O.	30/8	250/3600	SV13-SV14
	☆	DSH081 C08-2 2 Position, 2 Way, N.C. or N.O.	30/8	350/5000	SV15-SV16
	☆	DSL101 C10-2 2 Position, 2 Way, N.C. or N.O.	60/15	250/3600	SV17-SV18
	☆	DSH101 C10-2 2 Position, 2 Way, N.C. or N.O.	60/15	350/5000	SV19-SV20
		DSH121 C12-2 2 Position, 2 Way, N.C. or N.O.	90/24	350/5000	SV21-SV22
		DS161 C16-2 2 Position, 2 Way, N.C. or N.O.	150/40	210/3000	SV23-SV24
	☆	DSH161* C16-2 2 Position, 2 Way, N.C. or N.O.	150/40	350/5000	SV25-SV26
		DS201 C20-2 2 Position, 2 Way, N.C. or N.O.	260/70	210/3000	SV27-SV28
	☆	DSL201* C20-2 2 Position, 2 Way, N.C. or N.O.	260/70	250/3600	SV29-SV30
<i>*The DSH161 and DSL201 will be available January 1, 2011</i>					
		GH02 01 C08-2 2 Position, 2 Way, N.C., with Flow Adj.	11/3	285/4000	SV31-SV32
		GS02 72/73 C08-2 Bi-Directional Poppet, N.C.	1.7/45	210/3000	SV33-SV34
		GS02 80*/81 C08-2 Bi-Directional Poppet, N.C.	58/15	350/5000	SV35-SV36
		GS04 80*/81 2R Bi-Directional Poppet, N.C.	76/20	350/5000	SV37-SV38
		GS06 80*/81 C16-2 Bi-Directional Poppet, N.C.	285/75	350/5000	SV39-SV40
		GS02 77/78 C08-2 Bi-Directional Poppet, N.O.	1.7/45	210/3000	SV41-SV42
		GS02 85*/86 C08-2 Bi-Directional Poppet, N.O.	58/15	350/5000	SV43-SV44
		GS04 85*/86 2R Bi-Directional Poppet, N.O.	76/20	350/5000	SV45-SV46
		GS06 85*/86 C16-2 Bi-Directional Poppet, N.O.	285/75	350/5000	SV47-SV48
<i>*210/3000 psi rating</i>					

☆ Denotes New Winner's Circle Product Line.



	SERIES	CAVITY	DESCRIPTION	FLOW LPM/GPM	PRESSURE BAR/PSI	PAGE NO.
2 WAY SPOOL TYPE						
	☆ DSL082	C08-2	2 Position, 2 Way	15/4	250/3600	SV49-SV50
	☆ DSH082	C08-2	2 Position, 2 Way	15/4	350/5000	SV51-SV52
	☆ DSL102	C10-2	2 Position, 2 Way	30/8	250/3600	SV53-SV54
	☆ DSH102	C10-2	2 Position, 2 Way	30/8	350/5000	SV55-SV56
	DS162	C16-2	2 Position, 2 Way	75/20	210/3000	SV57-SV58
3 WAY SPOOL TYPE						
	☆ DSL083	C08-3	2 Position, 3 Way	15/4	250/3600	SV59-SV61
	☆ DSH083	C08-3	2 Position, 3 Way	15/4	350/5000	SV62-SV64
	☆ DSL103	C10-3	2 Position, 3 Way	30/8	250/3600	SV65-SV67
	☆ DSH103	C10-3	2 Position, 3 Way	30/8	350/5000	SV68-SV70
	DS163	C16-3	2 Position, 3 Way	57/15	210/3000	SV71-SV72
4 WAY, 2 POSITION SPOOL TYPE						
	☆ DSL084	C08-4	2 Position, 4 Way	15/4	250/3600	SV73-SV74
	☆ DSH084	C08-4	2 Position, 4 Way	15/4	350/5000	SV75-SV76
	☆ DSL104	C10-4	2 Position, 4 Way	30/8	250/3600	SV77-SV78
	☆ DSH104	C10-4	2 Position, 4 Way	30/8	350/5000	SV79-SV80
	DSH164	C16-4	2 Position, 4 Way	113/30	350/5000	SV81-SV82
4 WAY, 3 POSITION SPOOL TYPE						
	GS02 51	C08-4	3 Position, 4 Way	17/4.5	350/5000	SV83-SV84
	GS02 53	C08-4	3 Position, 4 Way	15/4	350/5000	SV85-SV86
	GS02 57	C08-4	3 Position, 4 Way	13/3.5	350/5000	SV87-SV88
	GS02 59	C08-4	3 Position, 4 Way	13/3.5	350/5000	SV89-SV90
	☆ DSL105	C10-4	3 Position, 4 Way	19/5	250/3600	SV91-SV92
	GS04 52D	C10-4	3 Position, 4 Way	20/8	350/5000	SV93-SV94
	GS04 54D	C10-4	3 Position, 4 Way	38/10	350/5000	SV95-SV96
	GS04 57D	C10-4	3 Position, 4 Way	42/11	350/5000	SV97-SV98
	GS04 59D	C10-4	3 Position, 4 Way	42/11	350/5000	SV99-SV100
	DSH125 52	C12-4L	3 Position, 4 Way	57/15	350/5000	SV101-SV102
	DSH125 54	C12-4L	3 Position, 4 Way	57/15	350/5000	SV103-SV104
	DSH125 57	C12-4L	3 Position, 4 Way	57/15	350/5000	SV105-SV106
	DSH125 59	C12-4L	3 Position, 4 Way	57/15	350/5000	SV107-SV108

- CV**
Check Valves
- SH**
Shuttle Valves
- LM**
Load/Motor Controls
- FC**
Flow Controls
- PC**
Pressure Controls
- LE**
Logic Elements
- DC**
Directional Controls
- MV**
Manual Valves
- SV**
Solenoid Valves
- PV**
Proportional Valves
- CE**
Coils & Electronics
- BC**
Bodies & Cavities
- TD**
Technical Data

☆ Denotes New Winner's Circle Product Line.



CV

Check Valves

SH

Shuttle Valves

LM

Load/Motor Controls

FC

Flow Controls

PC

Pressure Controls

LE

Logic Elements

DC

Directional Controls

MV

Manual Valves

SV

Solenoid Valves

PV

Proportional Valves

CE

Coils & Electronics

BC

Bodies & Cavities

TD

Technical Data

INTRODUCTION

This technical tips section is designed to help familiarize you with the Parker line of Solenoid Valves. In this section we highlight new products to this catalog as well as some design features of our solenoid valves. In addition we present common options available to help you in selecting products for your application. Finally, we give a brief synopsis of the operation and applications of the various products offered in this section. Some tips in applying and selecting our products are provided throughout this guide.

NEW PRODUCTS

There are several new additions and product improvements to our Solenoid Valve product line.

Here are just some of the design features and advantages to the product line.

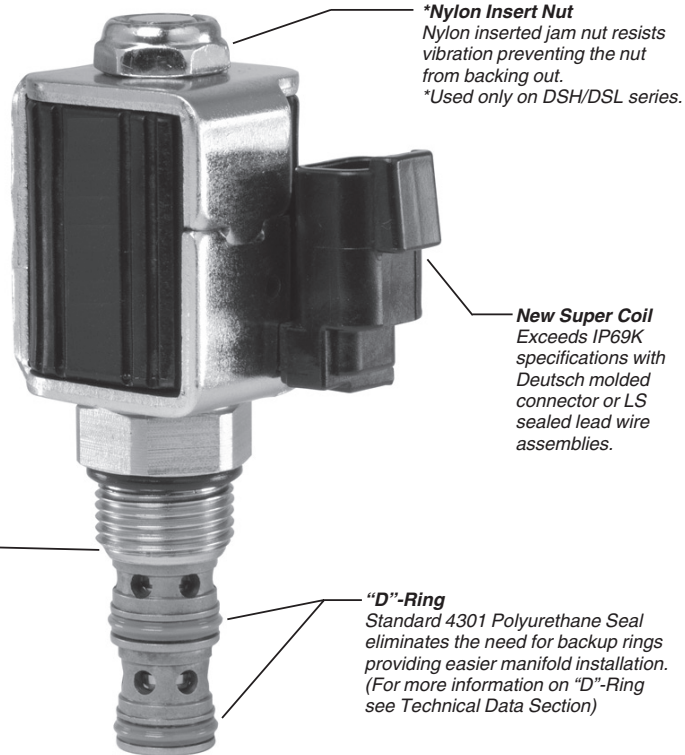

***Nylon Insert Nut**
Nylon inserted jam nut resists vibration preventing the nut from backing out.
**Used only on DSH/DSL series.*

New Super Coil
Exceeds IP69K specifications with Deutsch molded connector or LS sealed lead wire assemblies.

Crimp Design
Fold over crimp provides secure holding and eliminates the need for adhesive.

"D"-Ring
Standard 4301 Polyurethane Seal eliminates the need for backup rings providing easier manifold installation. (For more information on "D"-Ring see Technical Data Section)

New Parker SUPER COIL Now Available!

***Exceeds IP69k Specifications**

After exhaustive testing, the new Super Coil has clearly distanced itself from the competition. This coil was subjected to the rigors of this environmental standard and the results were excellent. This coil stands up to most rugged of environmental conditions including weather, dust, and extreme temperature variations.

***Water Dunk Test Qualified**

The Super Coil was taken to task in a repeated water dunk thermal cycle test program with alternate exposure to high and low temperature, only to perform with outstanding results.

***Endurance Tested**

The goal of this test was to cycle the coil to high temperature extremes in order to validate the coils ability to perform in extreme temperature environments.

***Water Spray and Chemical Solvent Compatibility**

The Super Coil was subjected to numerous chemical solvents in a rigorous test which established the fact that these coils can withstand harsh and unusual environments. Also, the coils were subjected to a high pressure water spray test. Once again, the Super Coil passed this test.

**Deutsch molded connector or LS option is highly recommended.*

NOTE: LS coil option will be available January 1, 2011.



COMMON OPTIONS

As you will see, Parker offers a variety of solenoid valve products. As such, some of the options mentioned below may not be available on all valves. Consult the model coding and dimensions for each valve for more specifics. Here are some of the common options available.

Seals: The Winner's Circle products feature a standard Polyurethane "D"-Ring. The "D"-Ring eliminates the need for backup rings. For more information on the "D"-Ring see the Technical Data section of the catalog. The majority of the products are available in Nitrile or Fluorocarbon Seals. You should always match the seal compatibility to the temperature and fluid being used in your application.

Coils: Coils can be ordered as part of the full assembly or separately. Various terminations and voltages are available. For detailed information on the coil options consult the coil section of the catalog. The ordering information for each valve will direct you to the proper coil.

Manual Overrides: Many of our solenoid valves are also offered with a manual override. The override allows the user to shift the valve when coil force is not available. They provide a means of shifting the solenoid valve due to a loss of power or a coil failure. Overrides are intended for infrequent usage and are not designed to be used as a primary method of valve actuation.

The most common override option for the 2 Position valves is the push & twist style shown below. With a normally closed valve or a pull style tube, the valve is in normal operation (or de-energized)

when the pin is seated in the slotted groove at the lowest position. To shift the valve manually, the operator pushes down on the knob and twists it counterclockwise. When the pressure is removed from the knob, an internal spring pushes the pin up the slotted groove to the upper position of the override. With a normally open valve, or push style tube, the actuation is reversed. The valve is in the normal position (or de-energized)

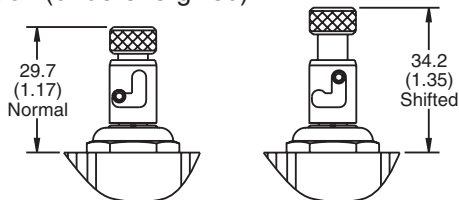

Normally Closed Pull Type Tube

when the pin is in the upper position of the override. To shift the valve manually, the operator pushes

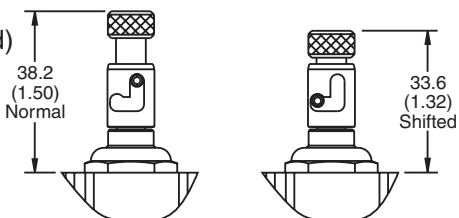

Normally Open Push Type Tube

down on the knob and twists is clockwise. Once the pin is seated in the slotted groove, the operator can remove pressure and the valve will stay actuated.

In addition to the push and twist style override, normally closed (pull style tube) 2 position valves can be ordered with a pull and release override. Normally open (push style) 2 position valves are available with flush style and extended style overrides. These overrides are not detented. Each style is shown below.

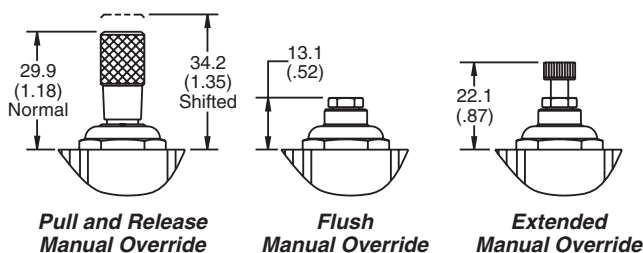

3 Position valves are offered with a Push / Pull style override. This override is not detented. Springs hold the spool of the valve in the center position of the valve. When the knob is pulled, the spool is moved upward simulating the action of the upper coil. When the override is pushed, the spool moves downward simulating the action of the lower coil. When no pressure is applied to the knob, it centers the spool.

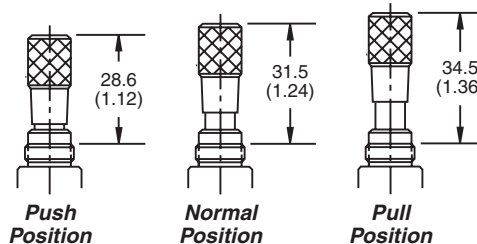

Screens: 2 way valves can be ordered with a small mesh screen (60 x 60 mesh) placed over the cage of the cartridge valve. This screen is intended for cursory protection of the internal components of the solenoid valve. It should not be used as the primary method of filtration. The mesh catches small pieces of debris that could impede spool or poppet movement. Note that a screen will trap debris from both directions. Thus, any debris coming from the nose of the cartridge would be trapped inside the valve. As such, we recommend that screens be implemented in only applications where hydraulic fluid passes through the cartridge from the side of the cage to the nose. It should also be noted that the pressure drop through the cartridge will be increased slightly due to the small restriction of the mesh. As the screen fills with debris, pressure drop will continue to rise.



- CV**
- Check Valves
- SH**
- Shuttle Valves
- LM**
- Load/Motor Controls
- FC**
- Flow Controls
- PC**
- Pressure Controls
- LE**
- Logic Elements
- DC**
- Directional Controls
- MV**
- Manual Valves
- SV**
- Solenoid Valves
- PV**
- Proportional Valves
- CE**
- Coils & Electronics
- BC**
- Bodies & Cavities
- TD**
- Technical Data

CV

Check Valves

SH

Shuttle Valves

LM

Load/Motor Controls

FC

Flow Controls

PC

Pressure Controls

LE

Logic Elements

DC

Directional Controls

MV

Manual Valves

SV

Solenoid Valves

PV

Proportional Valves

CE

Coils & Electronics

BC

Bodies & Cavities

TD

Technical Data

PRODUCT TYPES / APPLICATIONS

Two Way Poppet Valves

Two way poppet valves are pilot operated, low leakage solenoid actuated valves. Two way poppet valves control the flow of a two way function by blocking flow in one direction (similar to a check valve). They are generally selected due to their low leakage and ability to meet higher flow requirements. Poppet valves are often used on single operation actuators or in unloading functions. They are available in normally closed and normally open types. In addition, free reverse flow and fast response versions are available.

Normally Closed Poppet

Normally closed two way poppet valves act as a check valve when de-energized, blocking flow from one direction and allowing restricted free flow in the reverse condition. When energized, the poppet lifts allowing free flow from the side to the nose of the cartridge. Should the application require free flow in both directions, the free reverse flow option should be chosen.

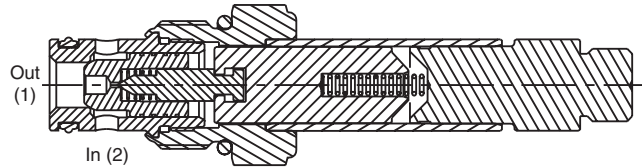
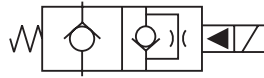

OPERATION - The valve pilot is held on its seat by spring force, blocking pilot flow. This allows pressure at the inlet (port 2) to hold the poppet on its seat, thus, preventing flow through the valve (2-1). If the nose of the cartridge (port 1) is pressurized, the pressure will overcome the spring force, pushing the poppet off of its seat, allowing free flow through the cartridge (1-2). When the coil is energized, the valve pilot is pulled off of its seat. This vents the pressure inside the poppet to port 1, creating a pressure imbalance across the main poppet. This differential lifts the poppet allowing flow from the side to nose (2-1). Since poppet valves are piloted operated, a minimum amount of pressure differential (25-50 psi) and flow between ports 2 and 1 must be present to overcome the spring and lift the poppet.

Normally Open Poppet

Normally open two way poppet valves, when de-energized, allow free flow from the side (port 2) of the cartridge to the nose (port 1). Flow in the reverse direction is restricted. Should free flow be required in both directions, the free reverse flow option should be specified. Once the coil is energized the normally open poppet valve acts as a check valve, blocking flow from one direction and allowing restricted free flow in the reverse condition.

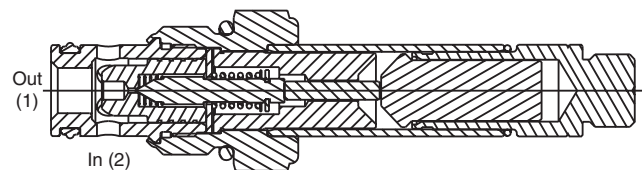
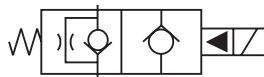

OPERATION - The valve pilot is held off its seat by spring force. Pilot flow is vented to port 1, creating a pressure imbalance that moves the main poppet. This differential lifts the poppet allowing flow from the side to nose (2-1). Since poppet valves are piloted operated, a minimum amount of pressure differential (25-50 psi) between ports 2 and 1 must be present to overcome the spring and lift the poppet. When the coil is energized, the coil force overcomes the spring force to drive the valve pilot and main poppet into their seats, thus blocking flow from port 2-1. If the nose of the cartridge (port 1) is pressurized, the pressure will overcome the spring force and solenoid force, pushing the poppet off of its seat, allowing restricted flow through the cartridge (1-2).

Free Reverse Flow

The free reverse flow versions are available on both the normally closed and normally open poppet valves. As mentioned above, the operation is the same as the standard poppet valve except flow through the reverse direction is not restricted. The free reverse flow option is only needed if the application requires flow to pass through the cartridge valve from the nose to side (port 1 to port 2).

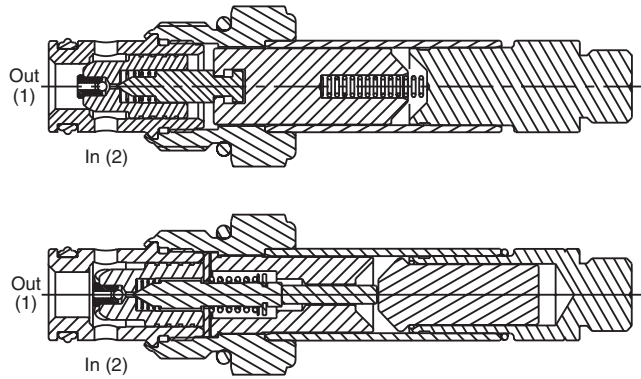
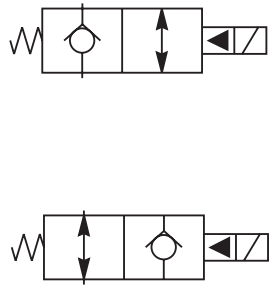

Fast Response

Since poppet valves are pilot operated valves, a few milliseconds are needed to move the pilot and allow the poppet to lift. Should a faster response time be required on normally closed poppet valves, this option can be chosen. The fast response is accomplished by reducing the movement of the pilot. Thus, the flow capacity of the poppet valve is also decreased.

Two Way Spool Valves

Two way spool valves are direct acting, fast responding solenoid actuated valves. Like the poppet valves described earlier, they block the flow of a two way function. Unlike two way poppet valves, spool valves block flow from both the side port and the nose port. They do not have the check like function of the poppet valve, thus they are either open or closed. Spool valves are directed operated, so they respond more quickly to coil voltage than poppet valves. Spool valves operate via a sliding spool, thus, some leakage will be present due to the required spool clearance. Spool valves block flow in both directions, but the preferred flow path is still from the side of the cartridge to the nose due to the flow forces acting on the spool. Two way spool valves are available in normally open and normally closed types.

Normally Closed Spool

When de-energized, the spool is positioned by the spring force to cover both the side (2) and nose (1) ports of the valve. Thus, no flow is allowed from either direction. Once the coil is energized, the spool shifts exposing a flow path between the two ports. Flow can then be passed through the valve from either direction.

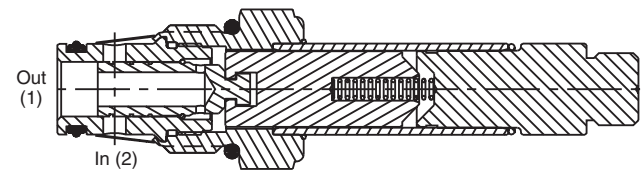

Normally Open Spool

When de-energized, the spool is positioned by the spring force so that a flow path between the side (2) and nose (1) ports is exposed, allowing flow through the valve from either direction. Once the coil is energized, the spool shifts to cover both the side (2) and nose (1) ports of the valve. Thus, no flow is allowed from either direction.

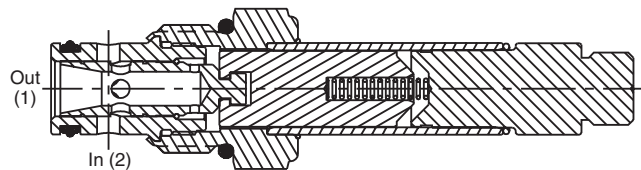

- CV**
Check Valves
- SH**
Shuttle Valves
- LM**
Load/Motor Controls
- FC**
Flow Controls
- PC**
Pressure Controls
- LE**
Logic Elements
- DC**
Directional Controls
- MV**
Manual Valves
- SV**
Solenoid Valves
- PV**
Proportional Valves
- CE**
Coils & Electronics
- BC**
Bodies & Cavities
- TD**
Technical Data

- CV** Check Valves
- SH** Shuttle Valves
- LM** Load/Motor Controls
- FC** Flow Controls
- PC** Pressure Controls
- LE** Logic Elements
- DC** Directional Controls
- MV** Manual Valves
- SV** Solenoid Valves
- PV** Proportional Valves
- CE** Coils & Electronics
- BC** Bodies & Cavities
- TD** Technical Data

Bi-Directional Poppet Valve

Bi-directional poppet valves combine the dual blocking function of spool valves with the lower leakage capabilities of poppet valves. These valves also have a limited flow capacity compared to standard poppet or spool valves.

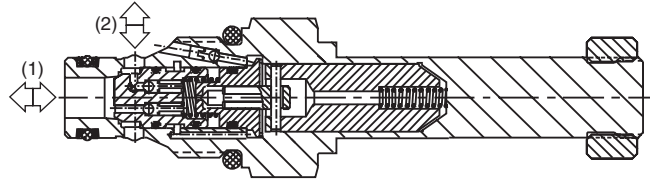
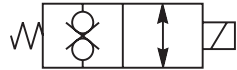

Two Position, Three Way Spool Valve

Three way spool solenoid valves provide directional control of flow. Each three way valve has a special internal spool which connects two of the three valve ports. When actuated, the spool connects a different combination of valve ports. These valves are often used for raise and lower functions of a single acting cylinder, control of a uni-directional motor, or as a circuit selector.

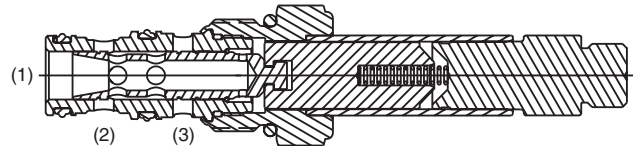
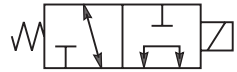

OPERATION - In the de-energized mode, the spool is positioned by spring force. When energized, the coil force directly shifts the spool against the spring, thus changing the flow through the valve. Each spool type can be used as a normally open, normally closed, or selector valve. To explain this we will review the DSL103A which is pictured here. When the valve is de-energized, ports 1 and 2 are open to one another. When energized, ports 1 and 3 are connected.

Thus, if we use port 3 as our pressure port, we have a

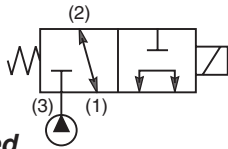

normally closed valve. The pressure port (3) is blocked, while the actuator port (1) is drained to tank (2).

If we use port 2 as our pressure port, we have a

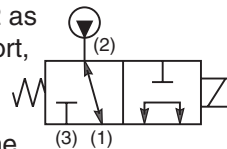

normally open valve. The pressure port (2) is connected to the actuator port (1), and the tank port (3) is blocked.

If we use port 1 as our pressure port, we have a

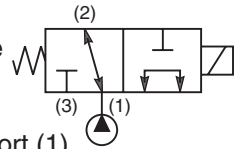

selector valve. The pressure port (1) is either connected to port (2) or port (3). Thus, it is "selecting" which port will get the system pressure and flow.

Note that in all three examples, we were using the same valve. The flow forces acting on the spool change depending on which port is pressurized. Thus, if you will be shifting the three way valve under full flow and pressure, it is important to review the shift limit characteristics for the flow paths you have chosen to be sure the coil has enough force to shift the spool. Various spools are available in this catalog to maximize the flow and pressure capacities for the desired flow function.

**Two Position,
Four Way Spool Valve**

Four way spool solenoid valves provide directional control of flow. Each four way valve has a special internal spool which connects some combination of the four valve ports together. When actuated, the spool connects a different combination of valve ports. These valves are often used for the raise / lower function of a double acting cylinder, or as a forward / reverse function of bi-directional motors.

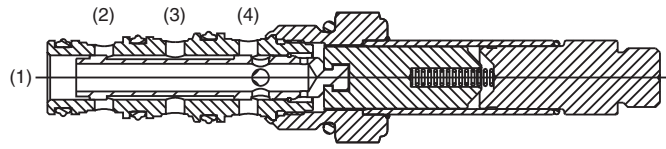
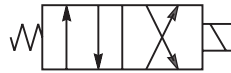

OPERATION - In the de-energized mode, the spool is positioned by spring force. When energized, the coil force directly shifts the spool against the spring, thus changing the flow through the valve. Each spool type is customized to provide the flow combination desired. The flow forces acting on the spool change depending on which port is pressurized. Thus, if you will be shifting the four way valve under full flow and pressure, it is important to review the shift limit characteristics for the flow paths you have chosen to ensure the coil has enough force to shift the spool. Various spools are shown in this catalog to maximize the flow and pressure capacities for the desired flow function.

**Three Position,
Four Way Spool Valve**

Three position, four way spool solenoid valves provide directional control of flow. Each four way valve has a special internal spool which connects some combination of the four ports together. When one coil is actuated, the spool connects a different combination of valve ports. When the other coil is actuated a third combination of valve ports are connected. These valves are often used for the raise / lower function of a double acting cylinder, or as a forward / reverse function of bi-directional motors. The center position can be used to stop the actuator in mid-stroke, or dump the pump flow.

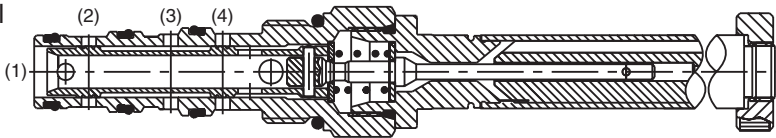

OPERATION - In the de-energized mode, the spool is positioned by spring force. When energized, the coil force directly shifts the against the spring, thus changing the flow through the valve. Each spool type is customized to provide the flow combination desired. The flow forces acting on the spool change depending on which port is pressurized. Thus, if you will be shifting the four way valve under full flow and pressure, it is important to review the shift limit characteristics for the flow paths you chosen to ensure the coil has enough force to shift the spool. Various spools are shown in this catalog to maximize the flow and pressure capacities for the desired flow function.

- CV**
Check Valves
- SH**
Shuttle Valves
- LM**
Load/Motor Controls
- FC**
Flow Controls
- PC**
Pressure Controls
- LE**
Logic Elements
- DC**
Directional Controls
- MV**
Manual Valves
- SV**
Solenoid Valves
- PV**
Proportional Valves
- CE**
Coils & Electronics
- BC**
Bodies & Cavities
- TD**
Technical Data

Technical Information

- CV** Check Valves
- SH** Shuttle Valves
- LM** Load/Motor Controls
- FC** Flow Controls
- PC** Pressure Controls
- LE** Logic Elements
- DC** Directional Controls
- MV** Manual Valves
- SV** Solenoid Valves
- PV** Proportional Valves
- CE** Coils & Electronics
- BC** Bodies & Cavities
- TD** Technical Data

General Description

2-Way, 2 Position, Normally Closed Spool Valve. For additional information see Technical Tips on pages SV1-SV6.

Features

- High flow capacity
- One piece cartridge housing ensures internal concentricity
- Coil: Waterproof, hermetically sealed, requires no O’Rings; Symmetrical coil can be reversed without affecting performance.

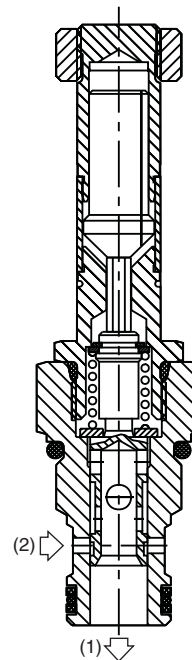
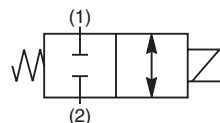

Specifications

Rated Flow (At 70 PSI ΔP)	13 LPM (3.5 GPM)
Maximum Inlet Pressure	350 Bar (5000 PSI)
Leakage at 150 SSU (32 cSt)	82 cc/min @ 210 Bar (3000 PSI)
Minimum Operating Voltage	85% of rated voltage at 20°C (72°F).
Cartridge Material	All parts steel. All operating parts hardened steel.
Operating Temp. Range/Seals	-40°C to +93.3°C (Nitrile) (-40°F to +200°F) -31.7°C to +121.1°C (Fluorocarbon) (-25°F to +250°F)
Fluid Compatibility/ Viscosity	Mineral-based or synthetic with lubricating properties at viscosities of 45 to 2000 SSU (6 to 420 cSt)
Filtration	ISO Code 16/13, SAE Class 4 or better
Approx. Weight	.14 kg (.31 lbs.)
Cavity	C09-2 (See BC Section for more details)

Performance Curves

Pressure Drop vs. Flow (Through cartridge only)

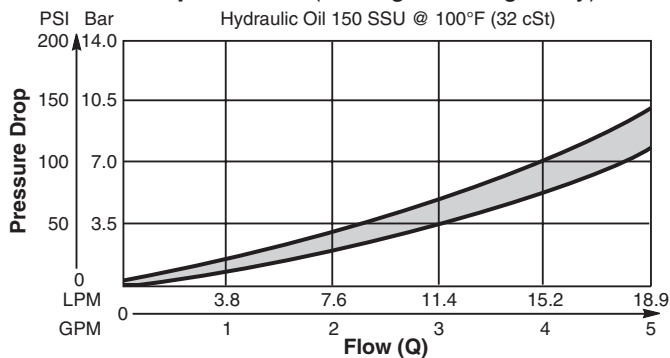

Operating Limits (Measured at 75% of Nominal Current)

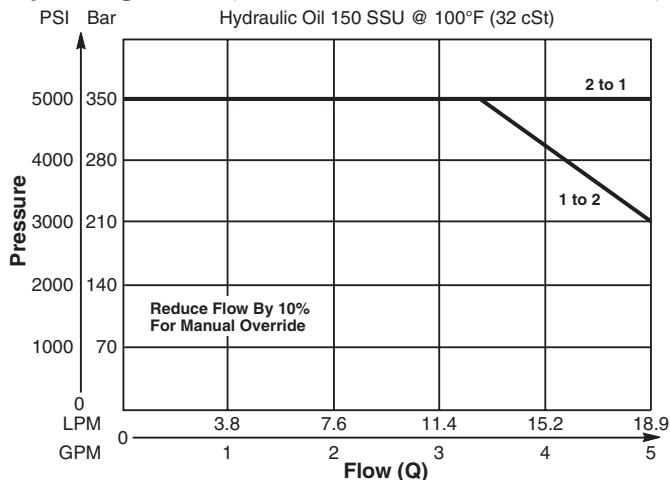

Dimensions Millimeters (Inches)

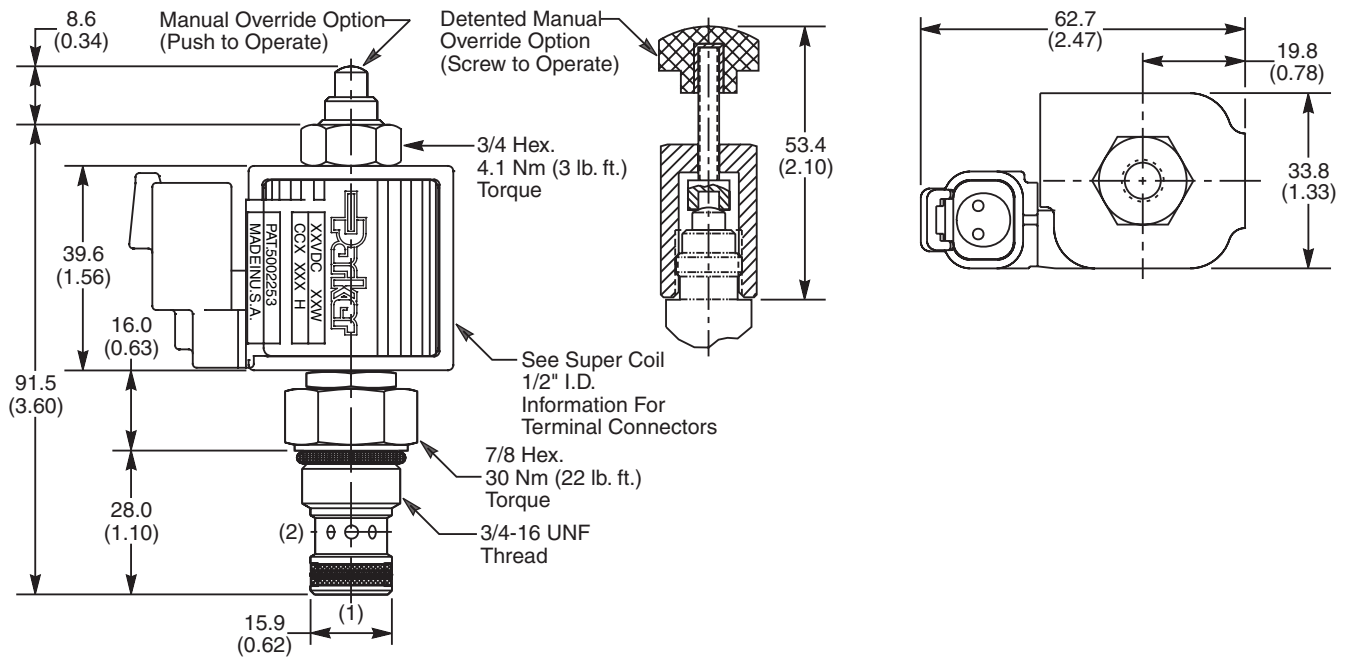

Ordering Information

GS02	22								
09 Size Solenoid Valve	Style Normally Closed	Override Option	Screen	Seals	Coil Type	Coil Voltage	Coil Termination	Body Material	Port Size

Code	Style
22	High Pressure ('SP' Coil)

Code	Seals / Kit No.
N	Nitrile / Buna-N (Std.) (SK30076N-1)
V	Fluorocarbon / (SK30076V-1)

Code	Coil Termination
Omit	Without Coil
C	Conduit With Leads
D	DIN Plug Face
A	Amp Jr. Timer*
S	Dual Spade*
L	Dual Lead Wire*
LS	Sealed Lead Wire*
H	Molded Deutsch*

Code	Body Material
Omit	Steel
A	Aluminum

Code	Override Options
0	None
1	Manual Override
2	Detented Part No. 900690

Code	Coil Type
Omit	Without Coil
SP	Super Coil - 19 Watts

Code	Port Size	Body Part No.
Omit		Cartridge Only
6T	SAE-6	(B09-2-*6T)
6B	3/8" BSPG	(B09-2-6B)†

Code	Screen
0	None

Code	Coil Voltage
Omit	Without Coil
D012	12 VDC
D024	24 VDC
A120	120 VAC, 60/50 Hz
A240	240 VAC, 60/50 Hz*

*22 Watts

See Super Coil 1/2" I.D.
*DC Only

* Add "A" for aluminum, omit for steel.
† Steel body only.

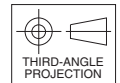

- CV Check Valves
- SH Shuttle Valves
- LM Load/Motor Controls
- FC Flow Controls
- PC Pressure Controls
- LE Logic Elements
- DC Directional Controls
- MV Manual Valves
- SV Solenoid Valves
- PV Proportional Valves
- CE Coils & Electronics
- BC Bodies & Cavities
- TD Technical Data

Technical Information

- CV** Check Valves
- SH** Shuttle Valves
- LM** Load/Motor Controls
- FC** Flow Controls
- PC** Pressure Controls
- LE** Logic Elements
- DC** Directional Controls
- MV** Manual Valves
- SV** Solenoid Valves
- PV** Proportional Valves
- CE** Coils & Electronics
- BC** Bodies & Cavities
- TD** Technical Data

General Description

2-Way, 2 Position, Normally Open Spool Valve.
For additional information see Technical Tips on pages SV1-SV6.

Features

- High flow capacity
- One piece cartridge housing ensures internal concentricity
- Coil: Waterproof, hermetically sealed, requires no O’Rings; Symmetrical coil can be reversed without affecting performance.

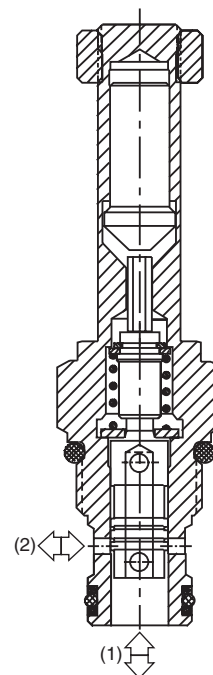
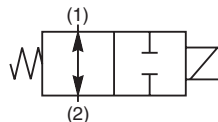

Specifications

Rated Flow (At 70 PSI ΔP)	15 LPM (4 GPM)
Maximum Inlet Pressure	350 Bar (5000 PSI)
Leakage at 150 SSU (32 cSt)	82 cc/min @ 210 Bar (3000 PSI)
Minimum Operating Voltage	85% of rated voltage at 20°C (72°F).
Cartridge Material	All parts steel. All operating parts hardened steel.
Operating Temp. Range/Seals	-40°C to +93.3°C (Nitrile) (-40°F to +200°F) -31.7°C to +121.1°C (Fluorocarbon) (-25°F to +250°F)
Fluid Compatibility/ Viscosity	Mineral-based or synthetic with lubricating properties at viscosities of 45 to 2000 SSU (6 to 420 cSt)
Filtration	ISO Code 16/13, SAE Class 4 or better
Approx. Weight	.14 kg (.31 lbs.)
Cavity	C09-2 (See BC Section for more details)

Performance Curves

Pressure Drop vs. Flow (Through cartridge only)

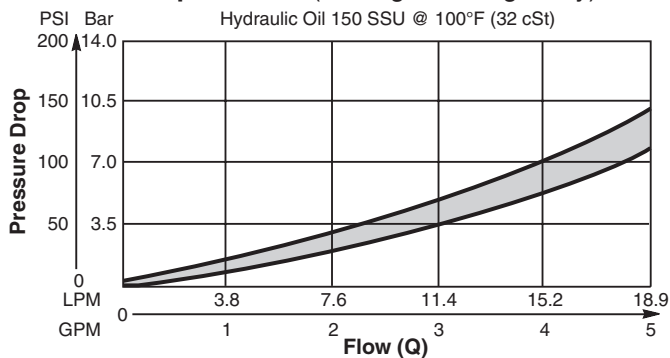

Operating Limits (Measured at 75% of Nominal Current)

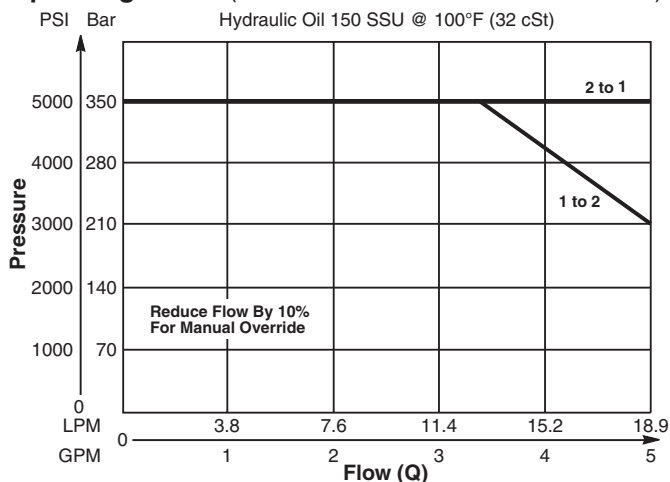

Technical Information

Dimensions Millimeters (Inches)

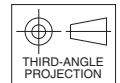
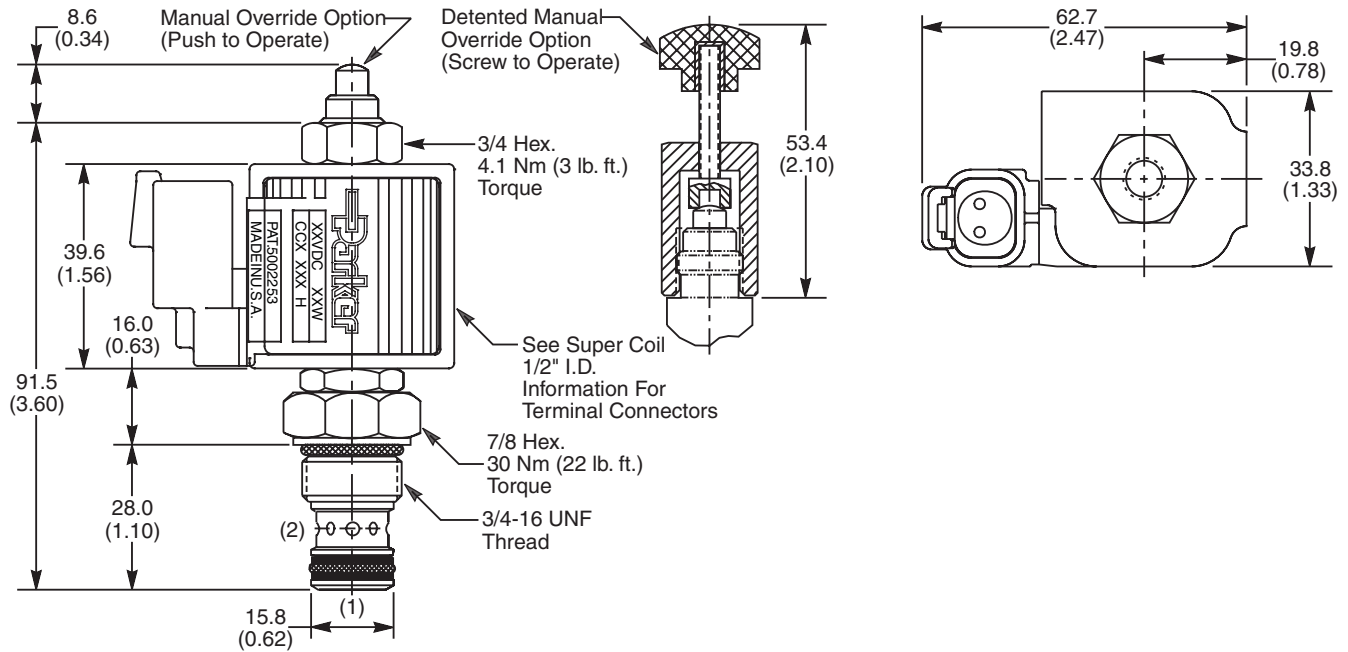

Ordering Information

GS02	27								
09 Size Solenoid Valve	Style Normally Open	Override Option	Screen	Seals	Coil Type	Coil Voltage	Coil Termination	Body Material	Port Size

Code	Style
27	High Pressure ('SP' Coil)

Code	Seals / Kit No.
N	Nitrile / Buna-N (Std.) (SK30076N-1)
V	Fluorocarbon / (SK30076V-1)

Code	Coil Termination
Omit	Without Coil
C	Conduit With Leads
D	DIN Plug Face
A	Amp Jr. Timer*
S	Dual Spade*
L	Dual Lead Wire*
LS	Sealed Lead Wire*
H	Molded Deutsch*

Code	Body Material
Omit	Steel
A	Aluminum

Code	Override Options
0	None
1	Manual Override
2	Detented Part No. 900690

Code	Coil Type
Omit	Without Coil
SP	Super Coil - 19 Watts

Code	Port Size	Body Part No.
Omit	Cartridge Only	
6T	SAE-6	(B09-2-*6T)
6B	3/8" BSPG	(B09-2-6B)†

Code	Screen
0	None

Code	Coil Voltage
Omit	Without Coil
D012	12 VDC
D024	24 VDC
A120	120 VAC, 60/50 Hz
A240	240 VAC, 60/50 Hz*

*22 Watts

See Super Coil 1/2" I.D.
*DC Only

* Add "A" for aluminum, omit for steel.
† Steel body only.



- CV Check Valves
- SH Shuttle Valves
- LM Load/Motor Controls
- FC Flow Controls
- PC Pressure Controls
- LE Logic Elements
- DC Directional Controls
- MV Manual Valves
- SV Solenoid Valves
- PV Proportional Valves
- CE Coils & Electronics
- BC Bodies & Cavities
- TD Technical Data

Technical Information

- CV** Check Valves
- SH** Shuttle Valves
- LM** Load/Motor Controls
- FC** Flow Controls
- PC** Pressure Controls
- LE** Logic Elements
- DC** Directional Controls
- MV** Manual Valves
- SV** Solenoid Valves
- PV** Proportional Valves
- CE** Coils & Electronics
- BC** Bodies & Cavities
- TD** Technical Data

General Description

4-Way, 2 Position, Reversing Spool Valve. For additional information see Technical Tips on pages SV1-SV6.

Features

- Designed to operate double and single acting cylinders, pilot circuits and bi-directional motors, etc.
- High flow capacity with reduced space requirements
- High pressure capacity to 350 Bar (5000 PSI)
- One piece cartridge housing ensures internal concentricity
- Coil: Waterproof, hermetically sealed, requires no O'Rings; Symmetrical coil can be reversed without affecting performance.
- Manual override available

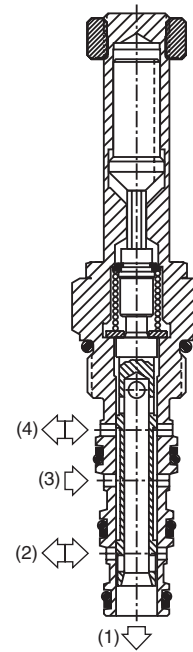
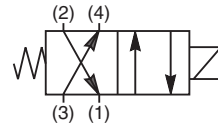
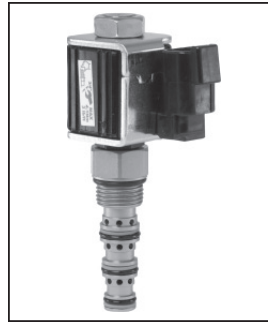

Specifications

Rated Flow (At 70 PSI ΔP)	19 LPM (5 GPM)
Maximum Inlet Pressure	350 Bar (5000 PSI)
Leakage at 150 SSU (32 cSt)	
Minimum Operating Voltage	85% of rated voltage at 20°C (72°F).
Cartridge Material	All parts steel. All operating parts hardened steel.
Operating Temp. Range/Seals	-40°C to +93.3°C (Nitrile) (-40°F to +200°F) -31.7°C to +121.1°C (Fluorocarbon) (-25°F to +250°F)
Fluid Compatibility/ Viscosity	Mineral-based or synthetic with lubricating properties at viscosities of 45 to 2000 SSU (6 to 420 cSt)
Filtration	ISO Code 16/13, SAE Class 4 or better
Approx. Weight	.30 kg (.66 lbs.)
Cavity	C08-4 (See BC Section for more details)

Performance Curves

Pressure Drop vs. Flow (Through cartridge only)

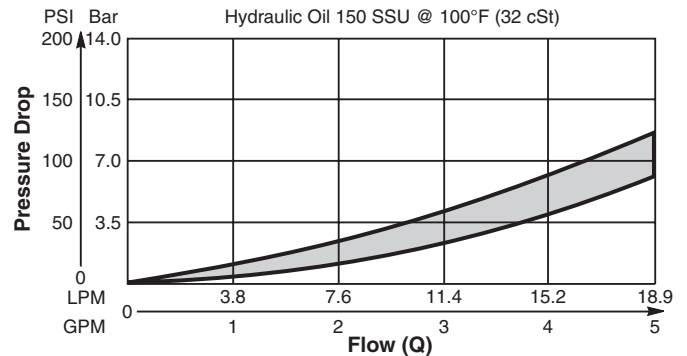

Operating Limits (Measured at 75% of Nominal Current)

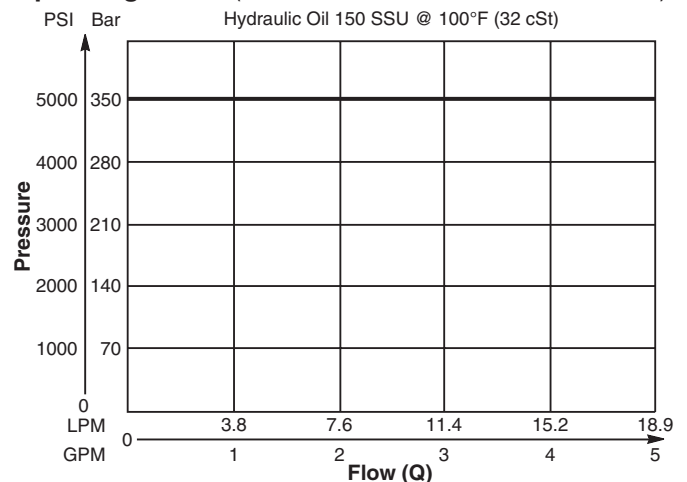

Technical Information

Dimensions Millimeters (Inches)

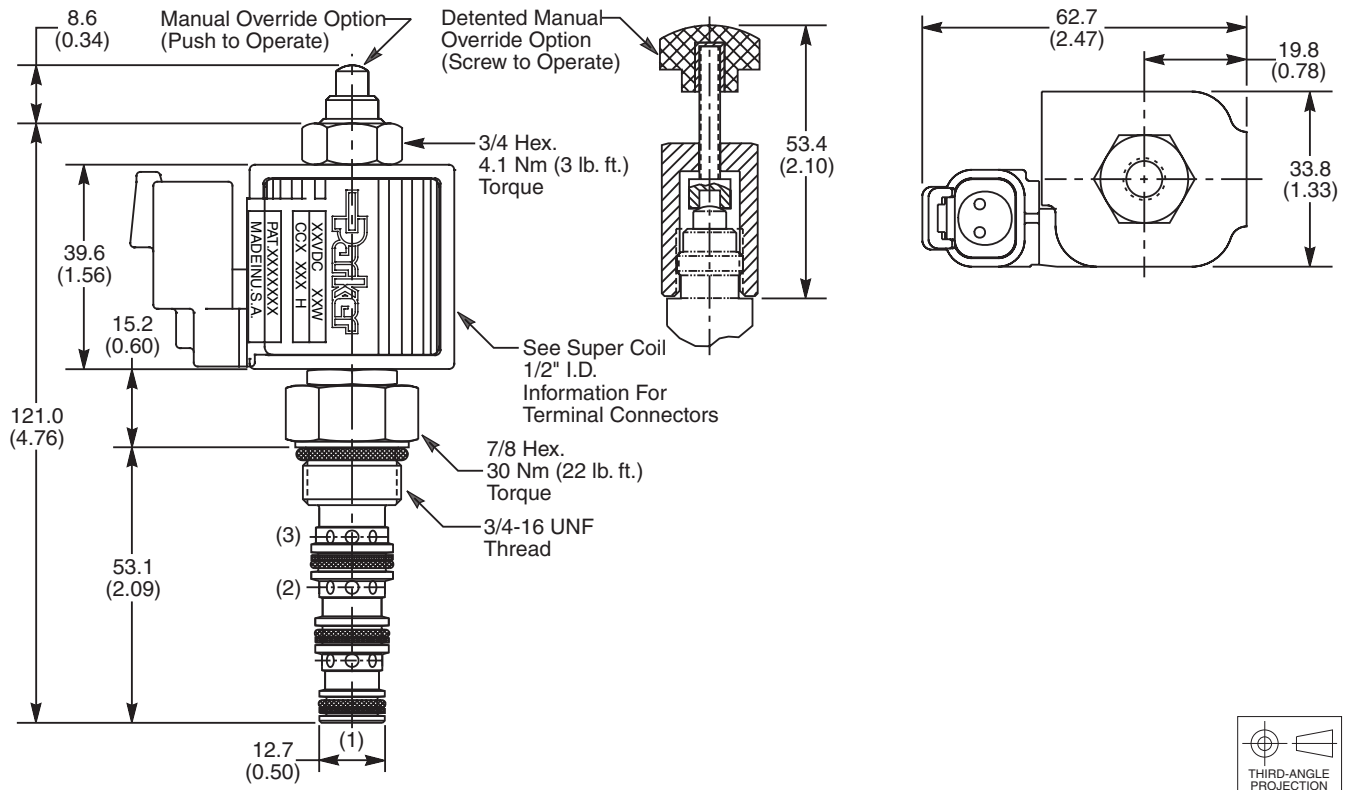

Ordering Information

GS02	42								
08 Size Solenoid Valve	Style	Override Option	Screen	Seals	Coil Type	Coil Voltage	Coil Termination	Body Material	Port Size

Code	Style
42	High Pressure ('SP' Coil)

Code	Seals / Kit No.
N	Nitrile / Buna-N (Std.) (SK30078N-1)
V	Fluorocarbon / (SK30078V-1)

Code	Coil Termination
Omit	Without Coil
C	Conduit With Leads
D	DIN Plug Face
A	Amp Jr. Timer*
S	Dual Spade*
L	Dual Lead Wire*
LS	Sealed Lead Wire*
H	Molded Deutsch*

Code	Body Material
Omit	Steel
A	Aluminum

Code	Override Options
0	None
1	Manual Override
2	Detented Part No. 900690

Code	Coil Type
Omit	Without Coil
SP	Super Coil - 19 Watts

Code	Port Size	Body Part No.
Omit	Cartridge Only	
6T	SAE-6	(B08-4-*6T)
6B	3/8" BSPG	(B08-4-*6B)

* Add "A" for aluminum, omit for steel.

Code	Screen
0	Not Available

Code	Coil Voltage
Omit	Without Coil
D012	12 VDC
D024	24 VDC
A120	120 VAC, 60/50 Hz
A240	240 VAC, 60/50 Hz*

*22 Watts

See Super Coil 1/2" I.D.
*DC Only

- CV Check Valves
- SH Shuttle Valves
- LM Load/Motor Controls
- FC Flow Controls
- PC Pressure Controls
- LE Logic Elements
- DC Directional Controls
- MV Manual Valves
- SV Solenoid Valves
- PV Proportional Valves
- CE Coils & Electronics
- BC Bodies & Cavities
- TD Technical Data

Technical Information

- CV** Check Valves
- SH** Shuttle Valves
- LM** Load/Motor Controls
- FC** Flow Controls
- PC** Pressure Controls
- LE** Logic Elements
- DC** Directional Controls
- MV** Manual Valves
- SV** Solenoid Valves
- PV** Proportional Valves
- CE** Coils & Electronics
- BC** Bodies & Cavities
- TD** Technical Data

General Description

2-Way Poppet Valves. For additional information see Technical Tips on pages SV1-SV6.



Features

- Replaceable, one piece encapsulated, coils with minimal amperage draw
- Variety of coil terminations and voltages
- Variety of manual override options available
- Fast response available, (CH and CHR) rated at 15 LPM (4.0 GPM)
- Polyurethane "D"-Ring eliminates need for backup rings
- Spherical poppet for low leakage
- Nylon inserted jam-nut provides secure holding in high vibration applications
- All external parts zinc plated

Specifications

Rated Flow (At 70 PSI ΔP)	30 LPM (8 GPM)	
Maximum Inlet Pressure	250 Bar (3600 PSI)	
Leakage at 150 SSU (32 cSt)	5 drops/min. (.33 cc/min.)	
Minimum Operating Voltage	85% of rated voltage at 20°C (72°F).	
Response Time	Energized	De-Energized
C, CR	50 ms	50 ms
CH, CHR	30 ms	50 ms
N, NR	50 ms	40 ms
Cartridge Material	All parts steel. All operating parts hardened steel.	
Operating Temp. Range/Seals	-45°C to +93.3°C ("D"-Ring) (-50°F to +200°F) -31.7°C to +121.1°C (Fluorocarbon) (-25°F to +250°F)	
Fluid Compatibility/ Viscosity	Mineral-based or synthetic with lubricating properties at viscosities of 45 to 2000 SSU (6 to 420 cSt)	
Filtration	ISO Code 16/13, SAE Class 4 or better	
Approx. Weight	.11 kg (.25 lbs.)	
Cavity	C08-2 (See BC Section for more details)	
Form Tool	Rougher Finisher	None NFT08-2F

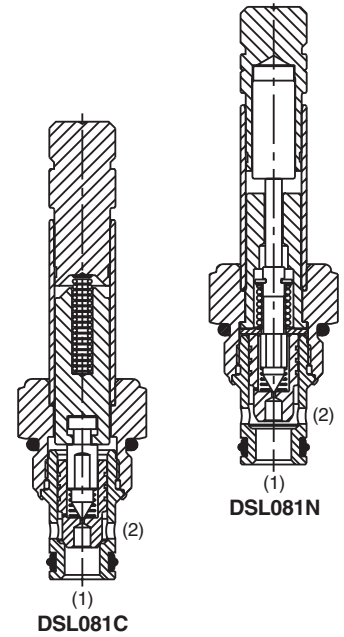
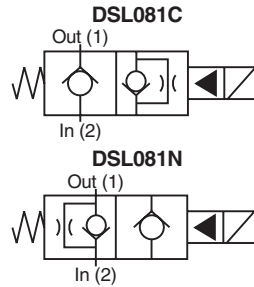

Performance Curves

Pressure Drop vs. Flow (Through cartridge only)

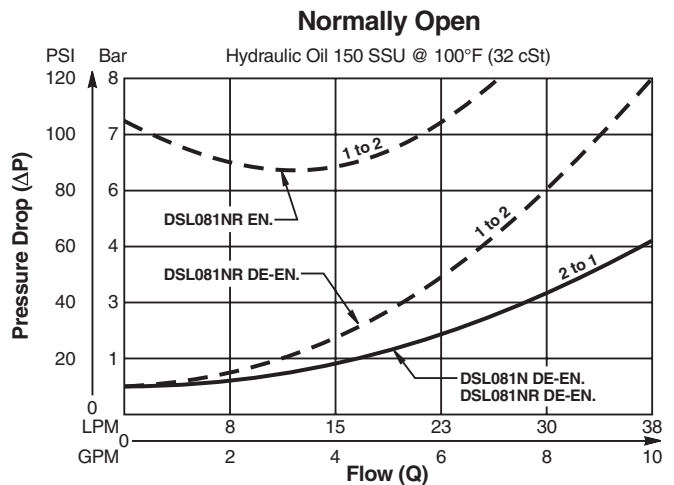
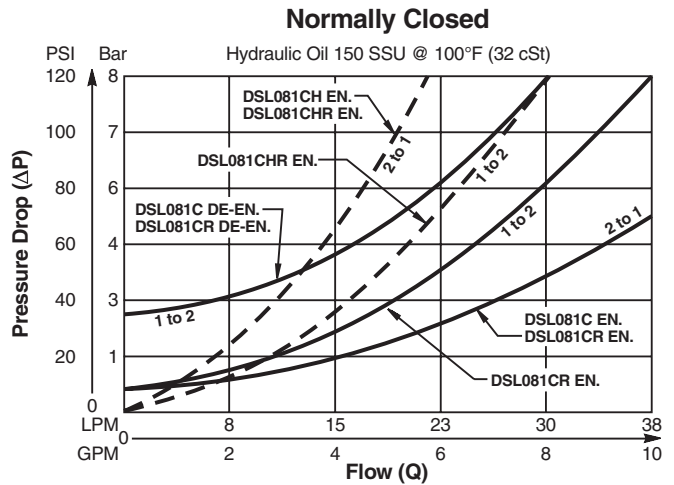

Dimensions Millimeters (Inches)

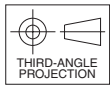
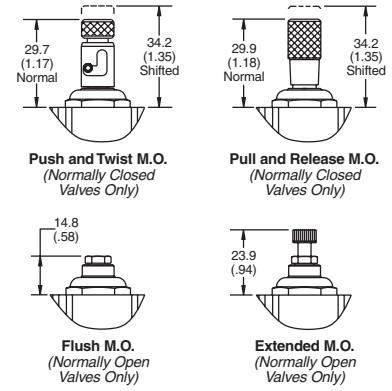
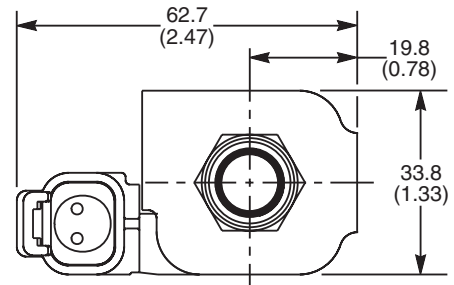
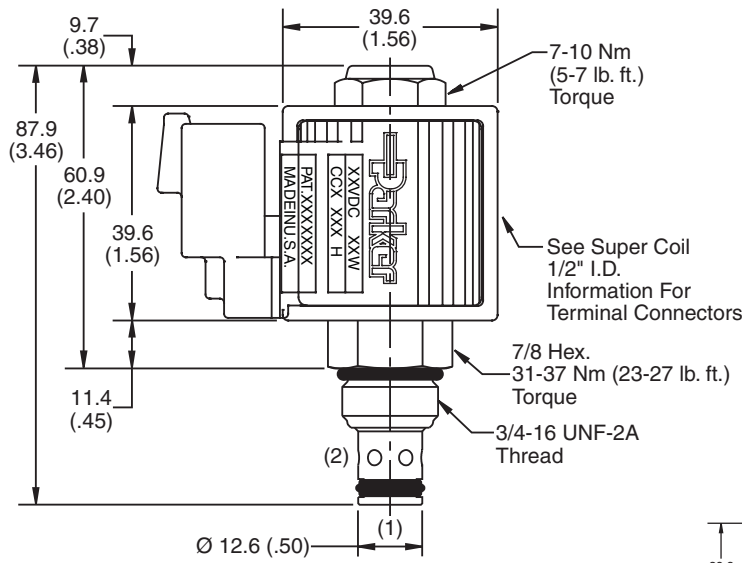

Ordering Information

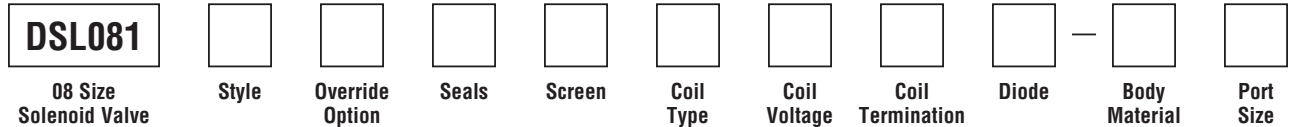

Code / Style	Symbol
C Normally Closed Metered reverse flow	
CH Normally Closed Metered reverse flow (Fast response)	
CHR Normally Closed Full reverse flow (Fast response)	
CR Normally Closed Free reverse flow	
N Normally Open Metered reverse flow	
NR Normally Open Free reverse flow	

Code	Override Options
Omit	None
E	Push Type with Extended Rod (N.O. Only)
M	Push Type with Flush Rod (N.O. Only)
P	Pull & Release (N.C. Only)
T	Push & Twist (N.C. & N.O.)

Code	Seals / Kit No.
Omit	"D"-Ring / (SK08-2)
N	Nitrile / (SK08-2N)
V	Fluorocarbon / (SK08-2V)

Code	Screen
Omit	None
S	Screen

Code	Coil Type
Omit	Without Coil
SP*	Super Coil - 19 Watts

**Recommended*

Code	Coil Voltage
Omit	Without Coil
D012	12 VDC
D024	24 VDC
A120	120/110 VAC, 60/50 Hz
A240	240/220 VAC, 60/50 Hz

SP* Coil	Coil Termination
Omit	Without Coil
C	Conduit With Leads
D	DIN Plug Face
A	Amp Jr. Timert†
S	Dual Spade†
L	Dual Lead Wire†
LS	Sealed Lead Wire†
H	Molded Deutsch†

Code	Diode
Omit	None
R	Diode

Code	Body Material
Omit	Steel
A	Aluminum

Code	Port Size	Body Part No.
Omit	Cartridge Only	
4P	1/4" NPTF	(B08-2-*4P)
6P	3/8" NPTF	(B08-2-*6P)
4T	SAE-4	(B08-2-*4T)
6T	SAE-6	(B08-2-*6T)
6B	3/8" BSPG	(B08-2-*6B)

** Add "A" for aluminum, omit for steel.*

**Recommended †DC Only*



- CV** Check Valves
- SH** Shuttle Valves
- LM** Load/Motor Controls
- FC** Flow Controls
- PC** Pressure Controls
- LE** Logic Elements
- DC** Directional Controls
- MV** Manual Valves
- SV** Solenoid Valves
- PV** Proportional Valves
- CE** Coils & Electronics
- BC** Bodies & Cavities
- TD** Technical Data

Technical Information

- CV** Check Valves
- SH** Shuttle Valves
- LM** Load/Motor Controls
- FC** Flow Controls
- PC** Pressure Controls
- LE** Logic Elements
- DC** Directional Controls
- MV** Manual Valves
- SV** Solenoid Valves
- PV** Proportional Valves
- CE** Coils & Electronics
- BC** Bodies & Cavities
- TD** Technical Data

General Description

2-Way Poppet Valves. For additional information see Technical Tips on pages SV1-SV6.



Features

- Replaceable, one piece encapsulated, coils with minimal amperage draw
- Variety of coil terminations and voltages
- Variety of manual override options available
- Fast response available, (CH and CHR) rated at 15 LPM (4.0 GPM)
- Polyurethane "D"-Ring eliminates need for backup rings
- Spherical poppet for low leakage
- Nylon inserted jam-nut provides secure holding in high vibration applications
- All external parts zinc plated

Specifications

Rated Flow (At 70 PSI ΔP)	30 LPM (8 GPM)	
Maximum Inlet Pressure	350 Bar (5000 PSI)	
Leakage at 150 SSU (32 cSt)	5 drops/min. (.33 cc/min.)	
Minimum Operating Voltage	85% of rated voltage at 20°C (72°F).	
Response Time	Energized	De-Energized
C, CR	50 ms	50 ms
CH, CHR	30 ms	50 ms
N, NR	50 ms	40 ms
Cartridge Material	All parts steel. All operating parts hardened steel.	
Operating Temp. Range/Seals	-45°C to +93.3°C ("D"-Ring) (-50°F to +200°F) -31.7°C to +121.1°C (Fluorocarbon) (-25°F to +250°F)	
Fluid Compatibility/Viscosity	Mineral-based or synthetic with lubricating properties at viscosities of 45 to 2000 SSU (6 to 420 cSt)	
Filtration	ISO Code 16/13, SAE Class 4 or better	
Approx. Weight	.11 kg (.25 lbs.)	
Cavity	C08-2 (See BC Section for more details)	
Form Tool	Rougher Finisher	None NFT08-2F

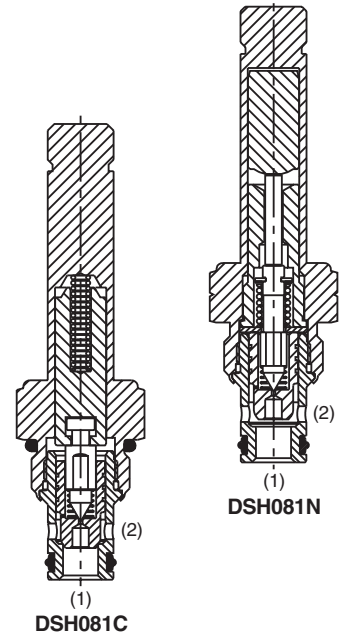
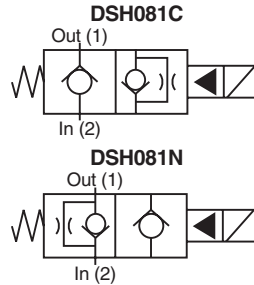

Performance Curves

Pressure Drop vs. Flow (Through cartridge only)

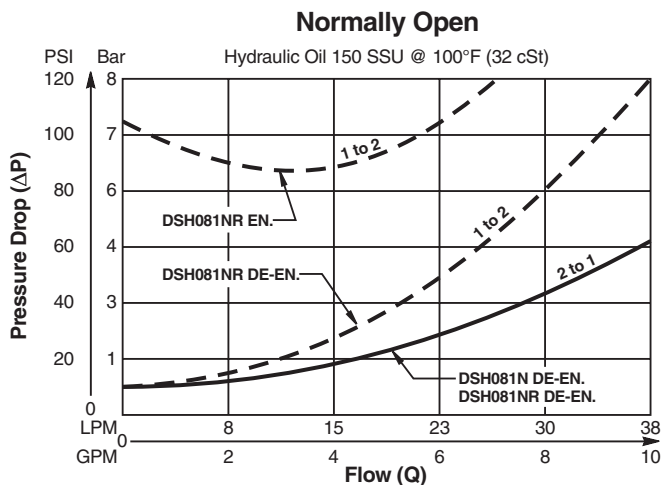
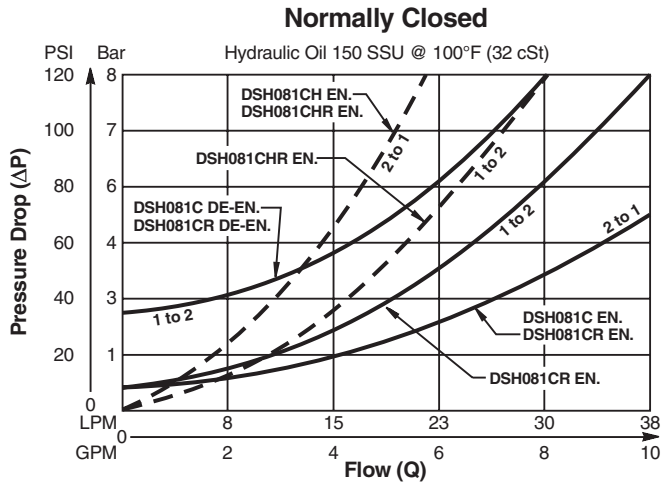

Dimensions Millimeters (Inches)

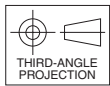
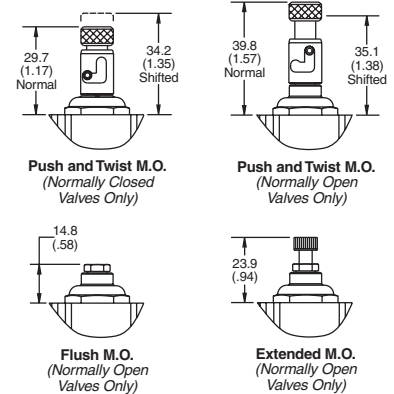
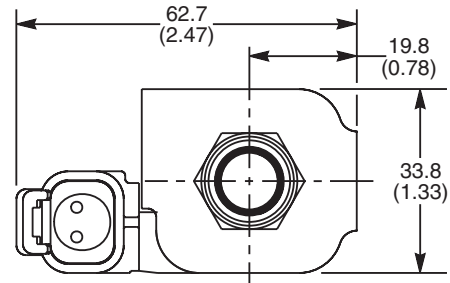
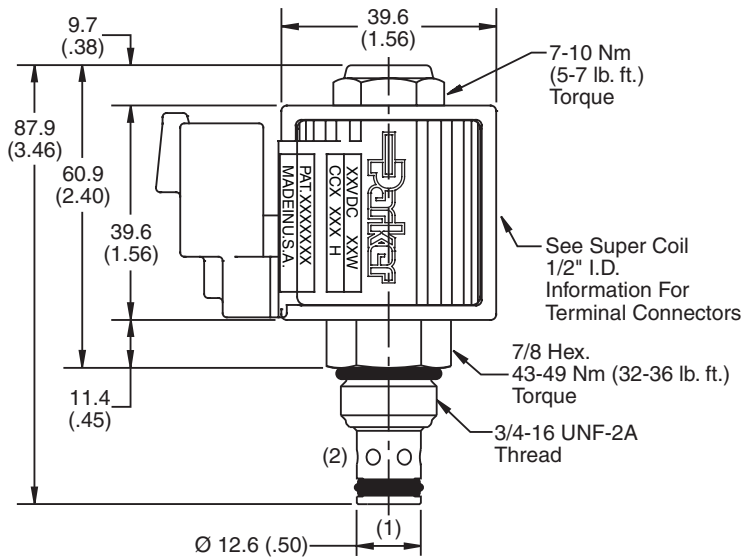

Ordering Information

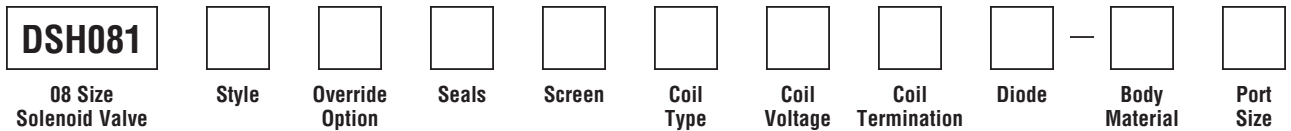

Code / Style	Diagram
C Normally Closed Metered reverse flow	
CH Normally Closed Metered reverse flow (Fast response)	
CHR Normally Closed Free reverse flow (Fast response)	
CR Normally Closed Free reverse flow	
N Normally Open Metered reverse flow	
NR Normally Open Free reverse flow	

Code	Override Options
Omit	None
E	Push Type with Extended Rod (N.O. Only)
M	Push Type with Flush Rod (N.O. Only)
T	Push & Twist (N.C.* & N.O.)

**Requires Super Coil*

Code	Seals / Kit No.
Omit	"D"-Ring / (SK08-2)
N	Nitrile / (SK08-2N)
V	Fluorocarbon / (SK08-2V)

Code	Screen
Omit	None
S	Screen

Code	Coil Type
Omit	Without Coil
SP*	Super Coil - 19 Watts

**Recommended*

Code	Coil Voltage
Omit	Without Coil
D012	12 VDC
D024	24 VDC
A120	120/110 VAC, 60/50 Hz
A240	240/220 VAC, 60/50 Hz

SP* Coil	Coil Termination
Omit	Without Coil
C	Conduit With Leads
D	DIN Plug Face
A	Amp Jr. Timert†
S	Dual Spade†
L	Dual Lead Wire†
LS	Sealed Lead Wire†
H	Molded Deutsch†

**Recommended †DC Only*

Code	Diode
Omit	None
R	Diode

Code	Body Material
Omit	Steel
A	Aluminum

Code	Port Size	Body Part No.
Omit	Cartridge Only	
4P	1/4" NPTF	(B08-2-*4P)
6P	3/8" NPTF	(B08-2-*6P)
4T	SAE-4	(B08-2-*4T)
6T	SAE-6	(B08-2-*6T)
6B	3/8" BSPG	(B08-2-*6B)

** Add "A" for aluminum, omit for steel.*

- CV** Check Valves
- SH** Shuttle Valves
- LM** Load/Motor Controls
- FC** Flow Controls
- PC** Pressure Controls
- LE** Logic Elements
- DC** Directional Controls
- MV** Manual Valves
- SV** Solenoid Valves
- PV** Proportional Valves
- CE** Coils & Electronics
- BC** Bodies & Cavities
- TD** Technical Data

Technical Information

- CV** Check Valves
- SH** Shuttle Valves
- LM** Load/Motor Controls
- FC** Flow Controls
- PC** Pressure Controls
- LE** Logic Elements
- DC** Directional Controls
- MV** Manual Valves
- SV** Solenoid Valves
- PV** Proportional Valves
- CE** Coils & Electronics
- BC** Bodies & Cavities
- TD** Technical Data

General Description

2-Way Poppet Valves. For additional information see Technical Tips on pages SV1-SV6.



Features

- Low hysteresis
- Replaceable, one piece encapsulated coils with minimal amperage draw
- Various coil terminations and voltages
- Various manual override options
- Fast response available, (CH and CHR) rated at 11 LPM (3.0 GPM)
- Polyurethane "D"-Ring
- All external parts zinc plated

Specifications

Rated Flow (At 70 PSI ΔP)	60 LPM (15 GPM)		
Maximum Inlet Pressure	250 Bar (3600 PSI)		
Leakage at 150 SSU (32 cSt)	5 drops/min. (.33 cc/min.)		
Minimum Operating Voltage	85% of rated voltage at 20°C (72°F).		
Response Time		Energized	De-Energized
	C, CR	80 ms	150 ms
	CH, CHR	50 ms	50 ms
	N, NR	35 ms	175 ms
Cartridge Material	All parts steel. All operating parts hardened steel.		
Operating Temp. Range/Seals	-45°C to +93.3°C ("D"-Ring) (-50°F to +200°F) -31.7°C to +121.1°C (Fluorocarbon) (-25°F to +250°F)		
Fluid Compatibility/Viscosity	Mineral-based or synthetic with lubricating properties at viscosities of 45 to 2000 SSU (6 to 420 cSt)		
Filtration	ISO Code 16/13, SAE Class 4 or better		
Approx. Weight	.20 kg (0.41 lbs.)		
Cavity	C10-2 (See BC Section for more details)		
Form Tool	Rougher Finisher	None	NFT10-2F

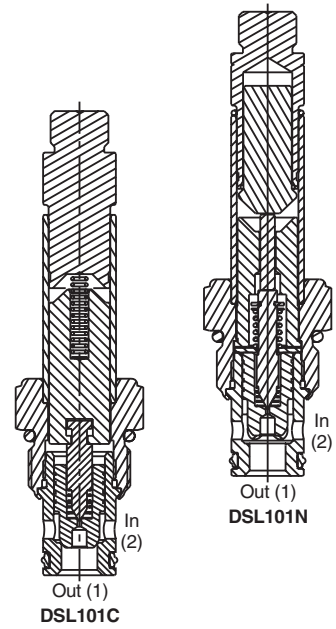
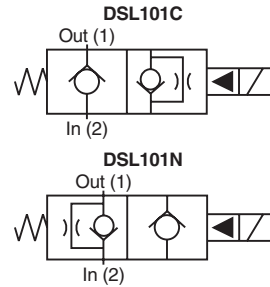

Performance Curves

Pressure Drop vs. Flow (Through cartridge only)

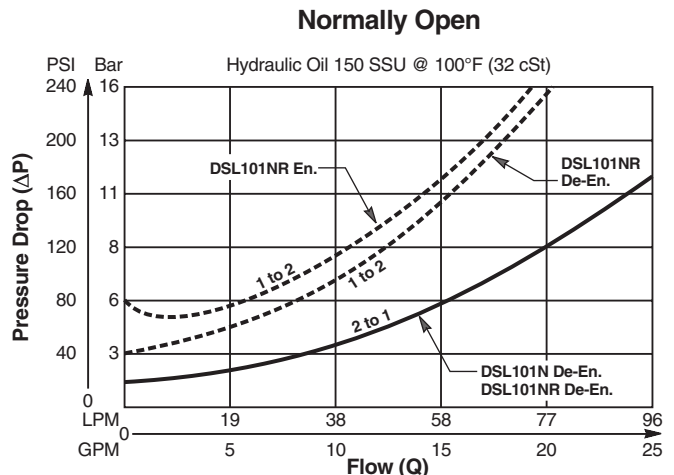
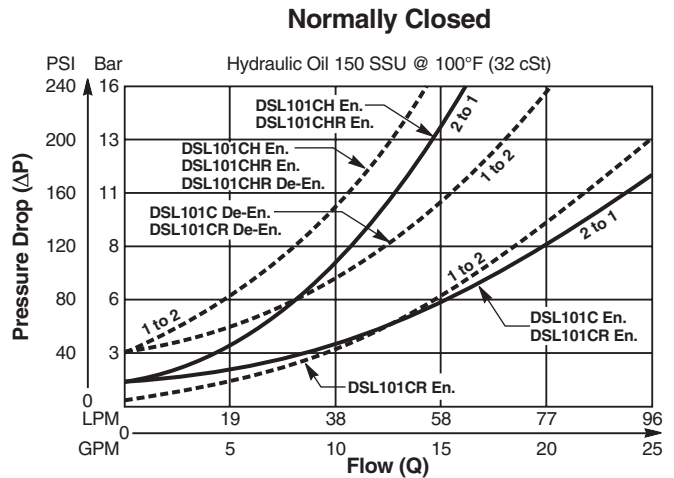

Dimensions Millimeters (Inches)

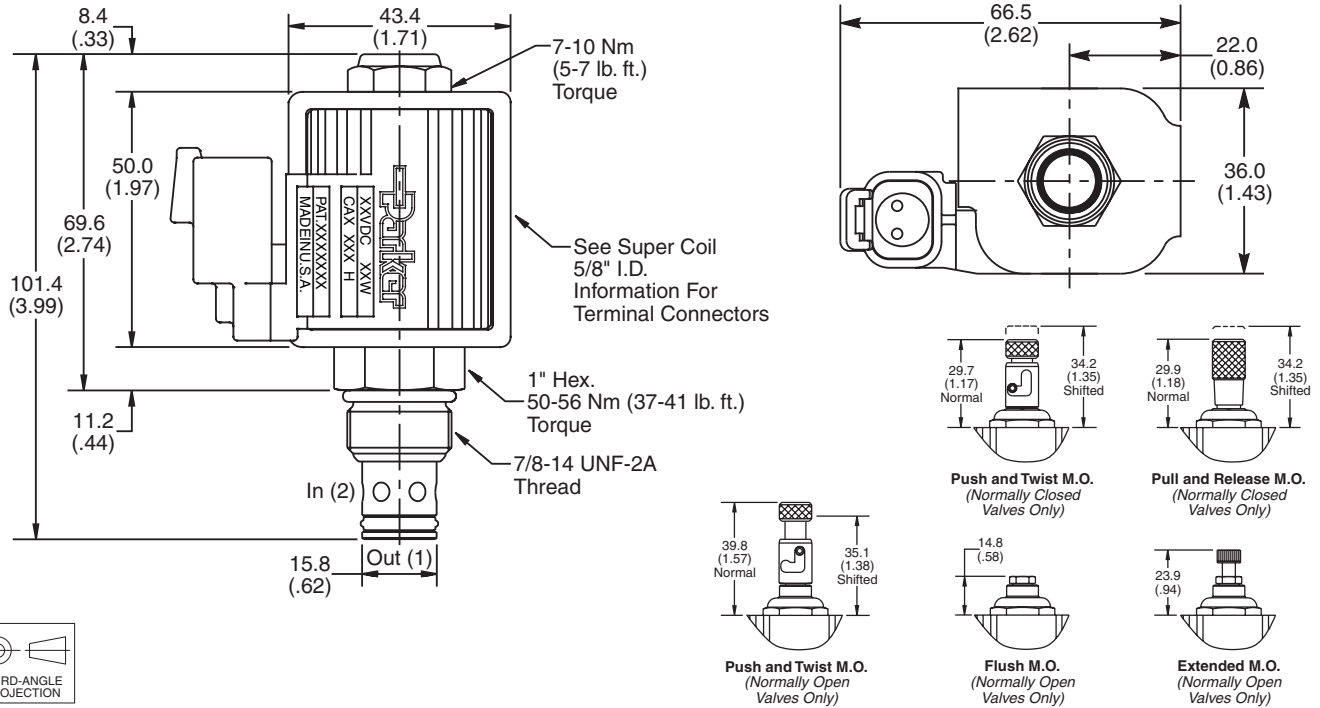

Ordering Information

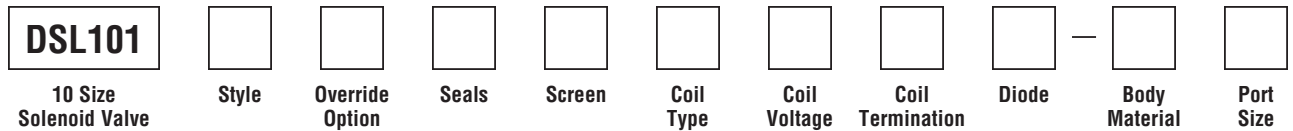

Code / Style	Diagram
C Normally Closed Metered reverse flow	
CH Normally Closed Metered reverse flow (Fast response)	
CHR Normally Closed Free reverse flow (Fast response)	
CR Normally Closed Free reverse flow	
N Normally Open Metered reverse flow	
NR Normally Open Free reverse flow	

Code	Override Options
Omit	None
E	Push Type with Extended Rod (N.O. Only)
M	Push Type with Flush Rod (N.O. Only)
P	Pull & Release (N.C. Only)
T	Push & Twist (N.C. & N.O.)

Code	Seals / Kit. No.
Omit	"D"-Ring / (SK10-2)
N	Nitrile / (SK10-2N)
V	Fluorocarbon / (SK10-2V)

Code	Screen
Omit	None
S	Screen

Code	Coil Type
Omit	Without Coil
SP*	Super Coil - 28 Watts

**Recommended*

Code	Coil Voltage
Omit	Without Coil
D012	12 VDC
D024	24 VDC
A120	120/110 VAC, 60/50 Hz
A240	240/220 VAC, 60/50 Hz

SP* Coil	Coil Termination
Omit	Without Coil
C	Conduit With Leads
D	DIN Plug Face
A	Amp Jr. Timert†
S	Dual Spade†
L	Dual Lead Wire†
LS	Sealed Lead Wire†
H	Molded Deutsch†

**Recommended †DC Only*

Code	Diode
Omit	None
R	Diode

Code	Body Material
Omit	Steel
A	Aluminum

Code	Port Size	Body Part No.
Omit	Cartridge Only	
4P	1/4" NPTF	(B10-2-*4P)
6P	3/8" NPTF	(B10-2-*6P)
8P	1/2" NPTF	(B10-2-*8P)
6T	SAE-6	(B10-2-*6T)
8T	SAE-8	(B10-2-*8T)
T8T	SAE-8	(B10-2-T8T)†
6B	3/8" BSPG	(B10-2-6B)†

** Add "A" for aluminum. omit for steel. † Steel body only.*

Technical Information

- CV** Check Valves
- SH** Shuttle Valves
- LM** Load/Motor Controls
- FC** Flow Controls
- PC** Pressure Controls
- LE** Logic Elements
- DC** Directional Controls
- MV** Manual Valves
- SV** Solenoid Valves
- PV** Proportional Valves
- CE** Coils & Electronics
- BC** Bodies & Cavities
- TD** Technical Data

General Description

2-Way Poppet Valves. For additional information see Technical Tips on pages SV1-SV6.



Features

- Low hysteresis
- Replaceable, one piece encapsulated coils with minimal amperage draw
- Various coil terminations and voltages
- Various manual override options
- Fast response available, (CH and CHR) rated at 30 LPM (8 GPM)
- Polyurethane "D"-Ring eliminates need for backup rings
- Nylon inserted jam-nut provides secure holding in high vibration applications
- All external parts zinc plated

Specifications

Rated Flow (At 70 PSI ΔP)	60 LPM (15 GPM)	
Maximum Inlet Pressure	350 Bar (5000 PSI)	
Leakage at 150 SSU (32 cSt)	5 drops/min. (.33 cc/min.)	
Minimum Operating Voltage	85% of rated voltage at 20°C (72°F).	
Response Time	Energized	De-Energized
	C, CR	80 ms / 150 ms
	CH, CHR	50 ms / 50 ms
	N, NR	70 ms / 35 ms
Cartridge Material	All parts steel. All operating parts hardened steel.	
Operating Temp. Range/Seals	-45°C to +93.3°C ("D"-Ring) (-50°F to +200°F) -31.7°C to +121.1°C (Fluorocarbon) (-25°F to +250°F)	
Fluid Compatibility/Viscosity	Mineral-based or synthetic with lubricating properties at viscosities of 45 to 2000 SSU (6 to 420 cSt)	
Filtration	ISO Code 16/13, SAE Class 4 or better	
Approx. Weight	.20 kg (0.41 lbs.)	
Cavity	C10-2 (See BC Section for more details)	
Form Tool	Rougher Finisher	None / NFT10-2F

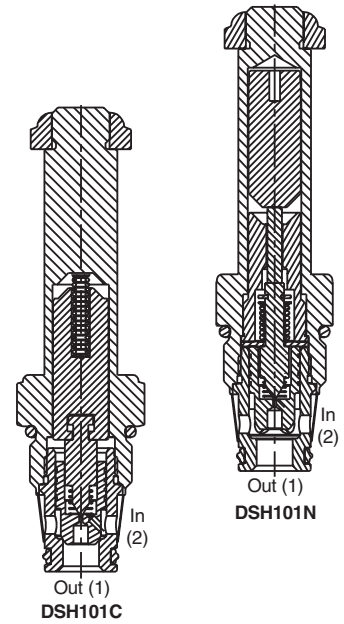
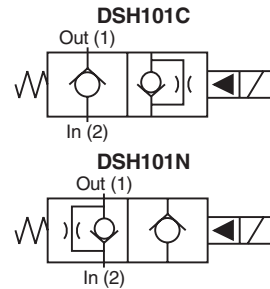

Performance Curves

Pressure Drop vs. Flow (Through cartridge only)

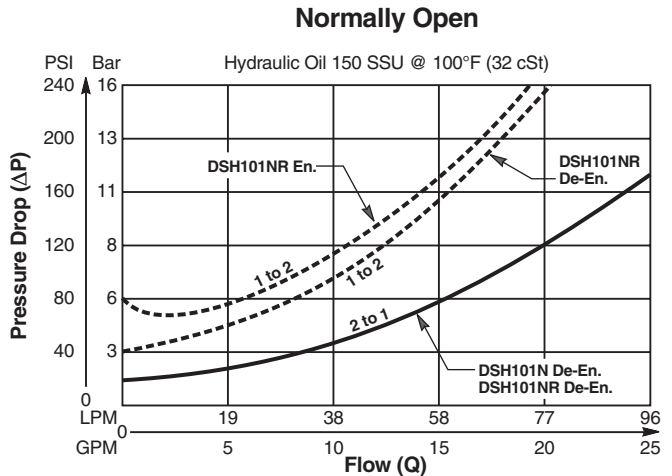
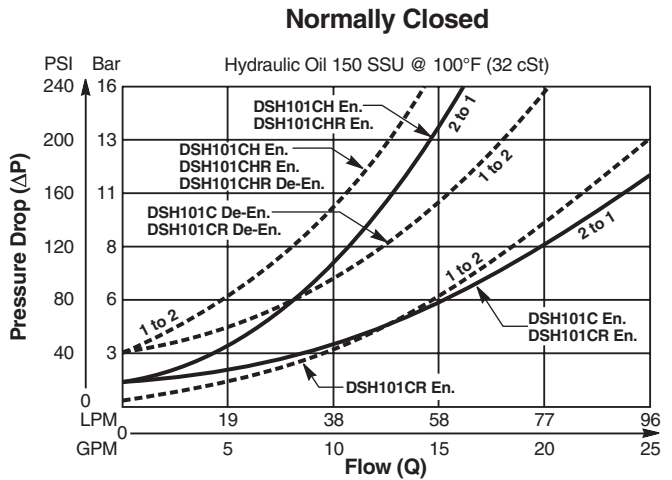

Dimensions Millimeters (Inches)

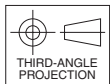
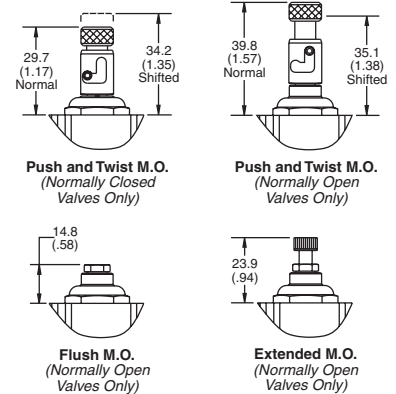
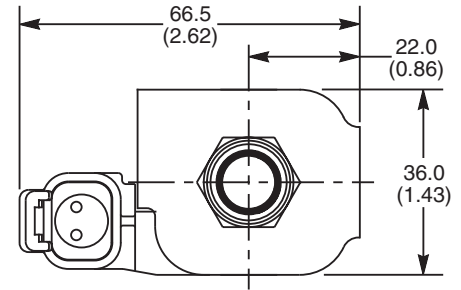
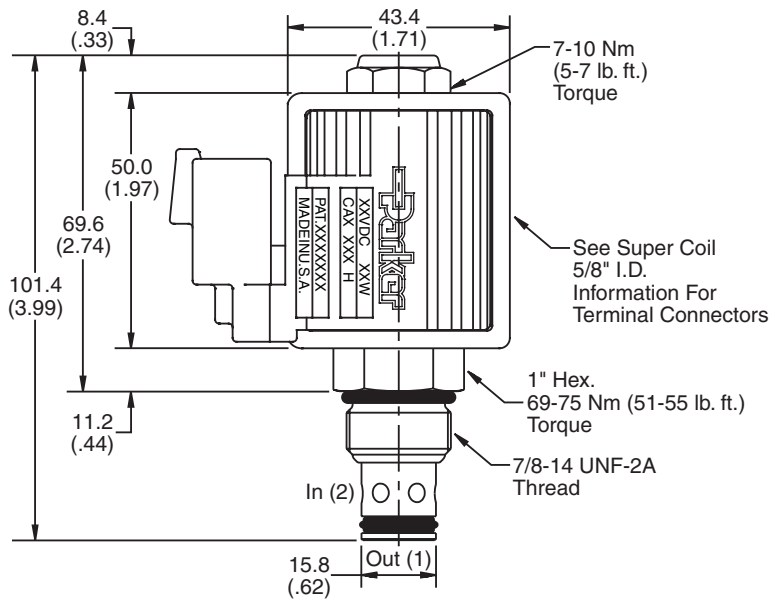

Ordering Information

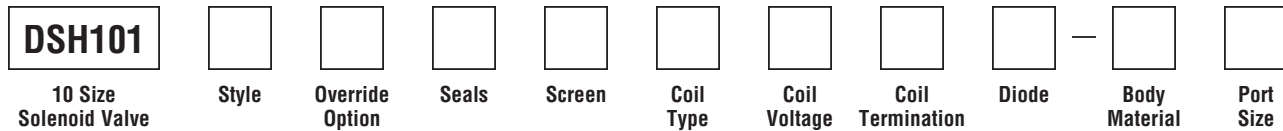

Code / Style	Diagram
C Normally Closed Metered reverse flow	
CH Normally Closed Metered reverse flow (Fast response)	
CHR Normally Closed Free reverse flow (Fast response)	
CR Normally Closed Free reverse flow	
N Normally Open Metered reverse flow	
NR Normally Open Free reverse flow	

Code	Override Options
Omit	None
E	Push Type with Extended Rod (N.O. Only)
M	Push Type with Flush Rod (N.O. Only)
T	Push & Twist (N.C. & N.O.)

Code	Seals / Kit No.
Omit	"D"-Ring / (SK10-2)
N	Nitrile / (SK10-2N)
V	Fluorocarbon / (SK10-2V)

Code	Screen
Omit	None
S	Screen

Code	Coil Type
Omit	Without Coil
SP*	Super Coil - 28 Watts

*Recommended

Code	Coil Voltage
Omit	Without Coil
D012	12 VDC
D024	24 VDC
A120	120/110 VAC, 60/50 Hz
A240	240/220 VAC, 60/50 Hz

SP* Coil	Coil Termination
Omit	Without Coil
C	Conduit With Leads
D	DIN Plug Face
A	Amp Jr. Timert†
S	Dual Spade†
L	Dual Lead Wire†
LS	Sealed Lead Wire†
H	Molded Deutsch†

*Recommended †DC Only

Code	Diode
Omit	None
R	Diode

Code	Body Material
Omit	Steel
A	Aluminum

Code	Port Size	Body Part No.
Omit	Cartridge Only	
4P	1/4" NPTF	(B10-2-*4P)
6P	3/8" NPTF	(B10-2-*6P)
8P	1/2" NPTF	(B10-2-*8P)
6T	SAE-6	(B10-2-*6T)
8T	SAE-8	(B10-2-*8T)
T8T	SAE-8	(B10-2-T8T)†
6B	3/8" BSPG	(B10-2-6B)†

* Add "A" for aluminum. omit for steel.
† Steel body only.



- CV**
- Check Valves
- SH**
- Shuttle Valves
- LM**
- Load/Motor Controls
- FC**
- Flow Controls
- PC**
- Pressure Controls
- LE**
- Logic Elements
- DC**
- Directional Controls
- MV**
- Manual Valves
- SV**
- Solenoid Valves
- PV**
- Proportional Valves
- CE**
- Coils & Electronics
- BC**
- Bodies & Cavities
- TD**
- Technical Data

Technical Information

- CV** Check Valves
- SH** Shuttle Valves
- LM** Load/Motor Controls
- FC** Flow Controls
- PC** Pressure Controls
- LE** Logic Elements
- DC** Directional Controls
- MV** Manual Valves
- SV** Solenoid Valves
- PV** Proportional Valves
- CE** Coils & Electronics
- BC** Bodies & Cavities
- TD** Technical Data

General Description

2-Way Poppet Valves. For additional information see Technical Tips on pages SV1-SV6.

Features

- Low hysteresis
- Replaceable, one piece encapsulated coils with minimal amperage draw
- Various coil terminations and voltages
- Various manual override options
- All external parts zinc plated

Specifications

Rated Flow	90 LPM (24 GPM)		
Maximum Inlet Pressure	350 Bar (5000 PSI)		
Leakage at 150 SSU (32 cSt)	5 drops/min. (.33 cc/min.)		
Minimum Operating Voltage	85% of rated voltage at 20°C (72°F).		
Response Time		Energized	De-Energized
	C, CR	100 ms	150 ms
	CH, CHR	60 ms	60 ms
	N, NR	70 ms	150 ms
Cartridge Material	All parts steel. All operating parts hardened steel.		
Operating Temp. Range/Seals	-40°C to +93.3°C (Nitrile) (-40°F to +200°F) -31.7°C to +121.1°C (Fluorocarbon) (-25°F to +250°F)		
Fluid Compatibility/ Viscosity	Mineral-based or synthetic with lubricating properties at viscosities of 45 to 2000 SSU (6 to 420 cSt)		
Filtration	ISO Code 16/13, SAE Class 4 or better		
Approx. Weight	.29 kg (.65 lbs.)		
Cavity	C12-2 (See BC Section for more details)		
Form Tool	Rougher	None	
	Finisher	NFT12-2F	

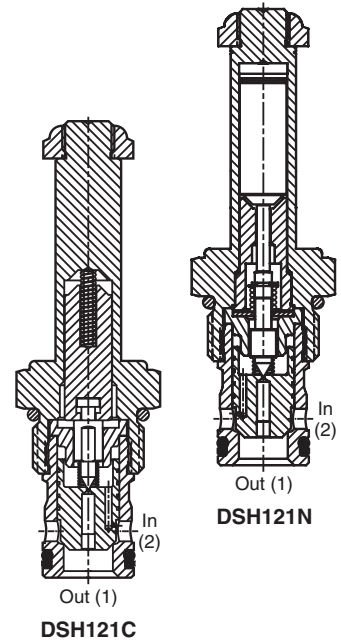
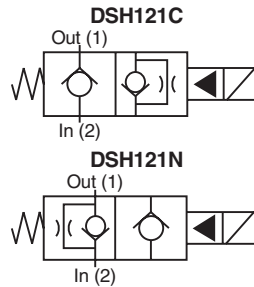

Performance Curves

Pressure Drop vs. Flow (Through cartridge only)

Normally Closed

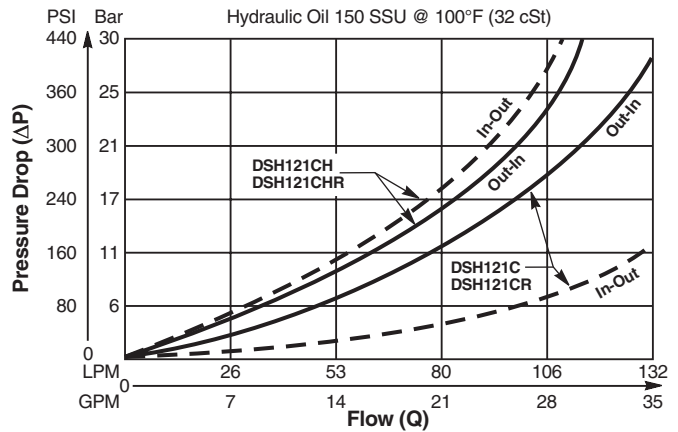

Normally Open

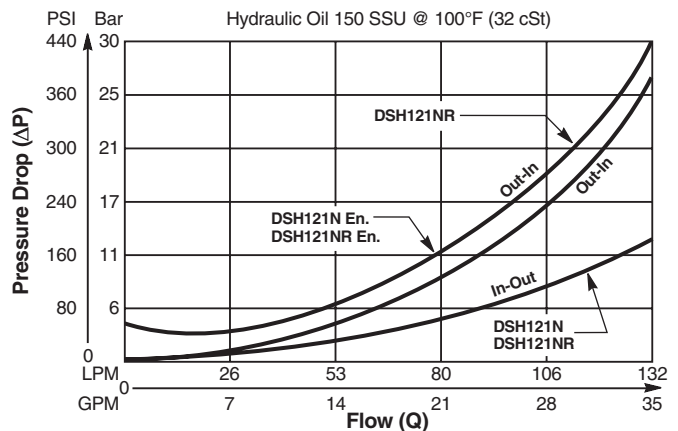

Dimensions Millimeters (Inches)

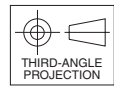
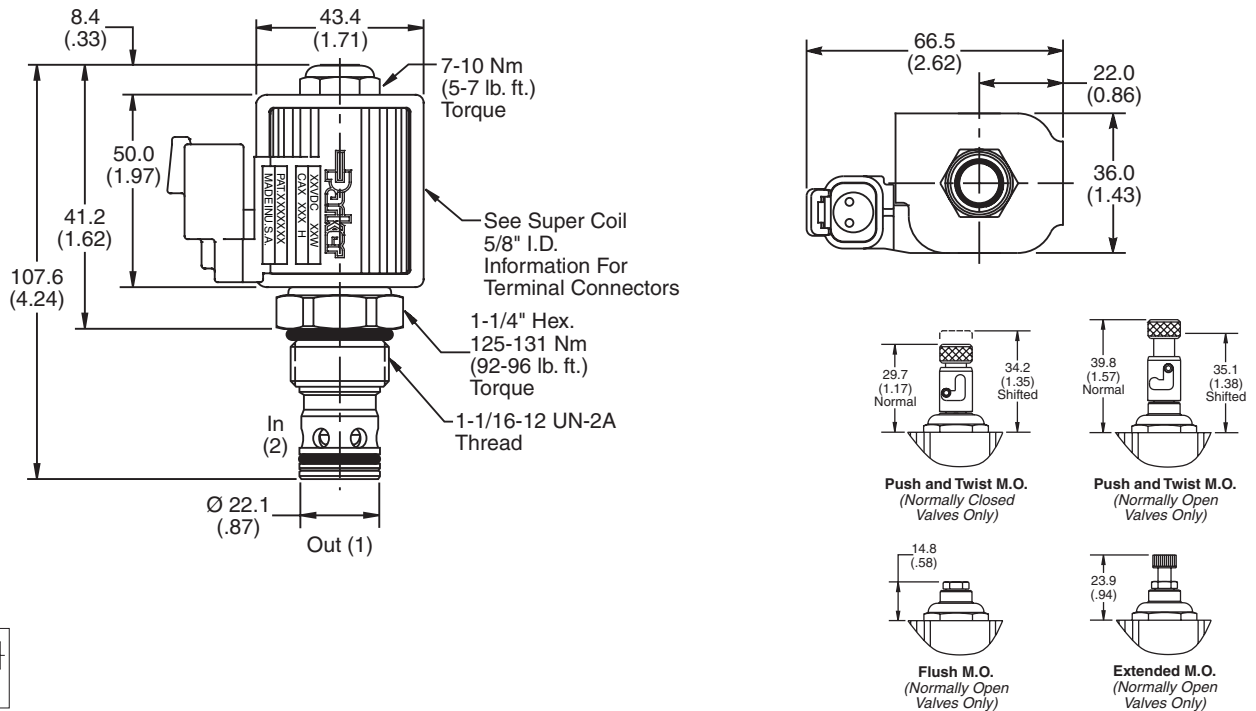

Ordering Information

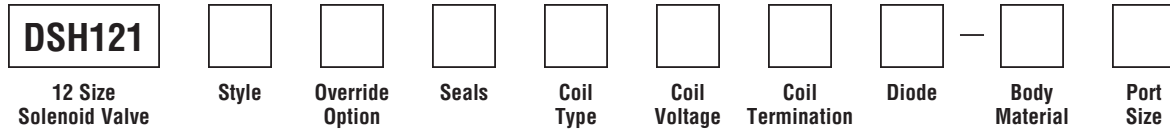

Code / Style	Symbol
C Normally Closed Metered reverse flow	
CH Normally Closed Metered reverse flow (Fast response)	
CHR Normally Closed Full reverse flow (Fast response)	
CR Normally Closed Free reverse flow	
N Normally Open Metered reverse flow	
NR Normally Open Free reverse flow	

Code	Override Options
Omit	None
E	Push Type with Extended Rod (N.O. Only)
M	Push Type with Flush Rod (N.O. Only)
T	Push & Twist (N.C. & N.O.)

Code	Seals / Kit No.
Omit	Nitrile / (SK12-2)
V	Fluorocarbon / (SK12-2V)

Code	Coil Type
Omit	Without Coil
SP*	Super Coil - 28 Watts

**Recommended*

Code	Coil Voltage
Omit	Without Coil
D012	12 VDC
D024	24 VDC
A120	120/110 VAC, 60/50 Hz
A240	240/220 VAC, 60/50 Hz

SP* Coil	Coil Termination
Omit	Without Coil
C	Conduit With Leads
D	DIN Plug Face
A	Amp Jr. Timert†
S	Dual Spade†
L	Dual Lead Wire†
LS	Sealed Lead Wire†
H	Molded Deutsch†

**Recommended †DC Only*

Code	Diode
Omit	None
R	Diode

Code	Body Material
Omit	Steel
A	Aluminum

Code	Port Size	Body Part No.
Omit		Cartridge Only
12P	3/4" NPTF	(B12-2-*12P)
8T	SAE-8	(B12-2-*8T)
12T	SAE-12	(B12-2-*12T)

** Add "A" for aluminum, omit for steel.*

- CV**
Check Valves
- SH**
Shuttle Valves
- LM**
Load/Motor Controls
- FC**
Flow Controls
- PC**
Pressure Controls
- LE**
Logic Elements
- DC**
Directional Controls
- MV**
Manual Valves
- SV**
Solenoid Valves
- PV**
Proportional Valves
- CE**
Coils & Electronics
- BC**
Bodies & Cavities
- TD**
Technical Data

Technical Information

- CV** Check Valves
- SH** Shuttle Valves
- LM** Load/Motor Controls
- FC** Flow Controls
- PC** Pressure Controls
- LE** Logic Elements
- DC** Directional Controls
- MV** Manual Valves
- SV** Solenoid Valves
- PV** Proportional Valves
- CE** Coils & Electronics
- BC** Bodies & Cavities
- TD** Technical Data

General Description

2-Way Poppet Valves. For additional information see Technical Tips on pages SV1-SV6.

Features

- Low hysteresis
- Replaceable, one piece encapsulated coils with minimal amperage draw
- Various coil terminations and voltages
- Various manual override options
- Fast response available, (CH) rated at 60 LPM (15 GPM)
- All external parts zinc plated

Specifications

Rated Flow	150 LPM (40 GPM)												
Maximum Inlet Pressure	210 Bar (3000 PSI)												
Leakage at 150 SSU (32 cSt)	20 drops/min. (1.33 cc/min.)												
Minimum Operating Voltage	85% of rated voltage at 20°C (72°F).												
Response Time	<table border="1" style="display: inline-table; vertical-align: middle;"> <tr> <td></td> <td>Energized</td> <td>De-Energized</td> </tr> <tr> <td>C, CR</td> <td>50 ms</td> <td>130 ms</td> </tr> <tr> <td>CH</td> <td>40 ms</td> <td>60 ms</td> </tr> <tr> <td>N, NR</td> <td>45 ms</td> <td>75 ms</td> </tr> </table>		Energized	De-Energized	C, CR	50 ms	130 ms	CH	40 ms	60 ms	N, NR	45 ms	75 ms
	Energized	De-Energized											
C, CR	50 ms	130 ms											
CH	40 ms	60 ms											
N, NR	45 ms	75 ms											
Cartridge Material	All parts steel. All operating parts hardened steel.												
Operating Temp. Range/Seals	-40°C to +93.3°C (Nitrile) (-40°F to +200°F) -31.7°C to +121.1°C (Fluorocarbon) (-25°F to +250°F)												
Fluid Compatibility/Viscosity	Mineral-based or synthetic with lubricating properties at viscosities of 45 to 2000 SSU (6 to 420 cSt)												
Filtration	ISO Code 16/13, SAE Class 4 or better												
Approx. Weight	.34 kg (.75 lbs.)												
Cavity	C16-2 (See BC Section for more details)												
Form Tool	Rougher None Finisher NFT16-2F												

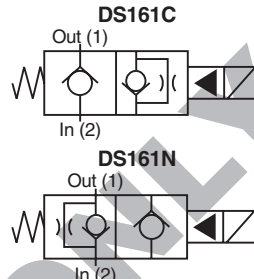
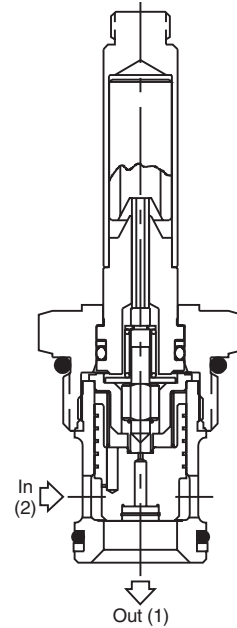
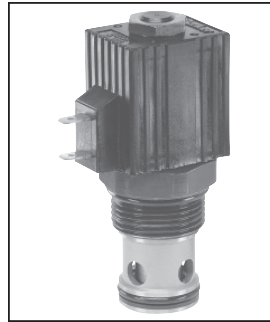

Performance Curves

Pressure Drop vs. Flow (Through cartridge only)

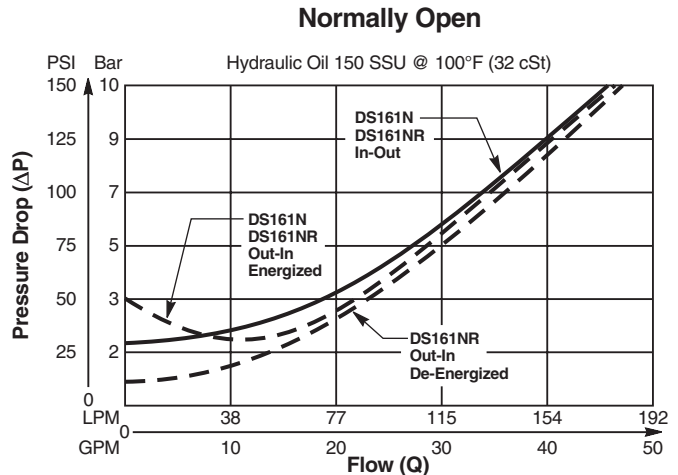
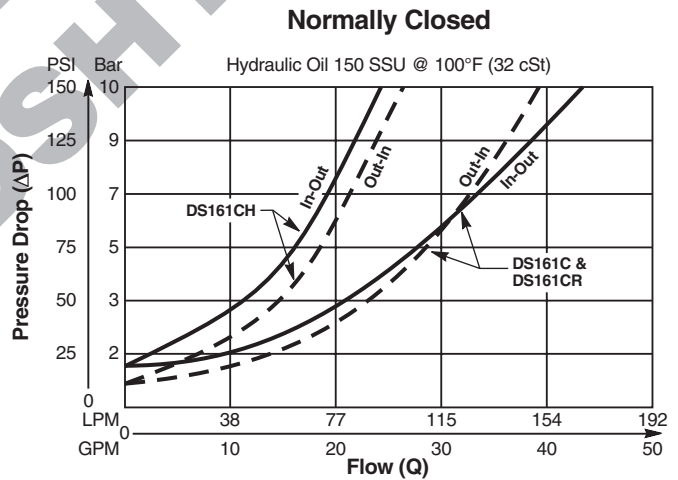

Dimensions Millimeters (Inches)

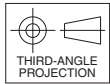
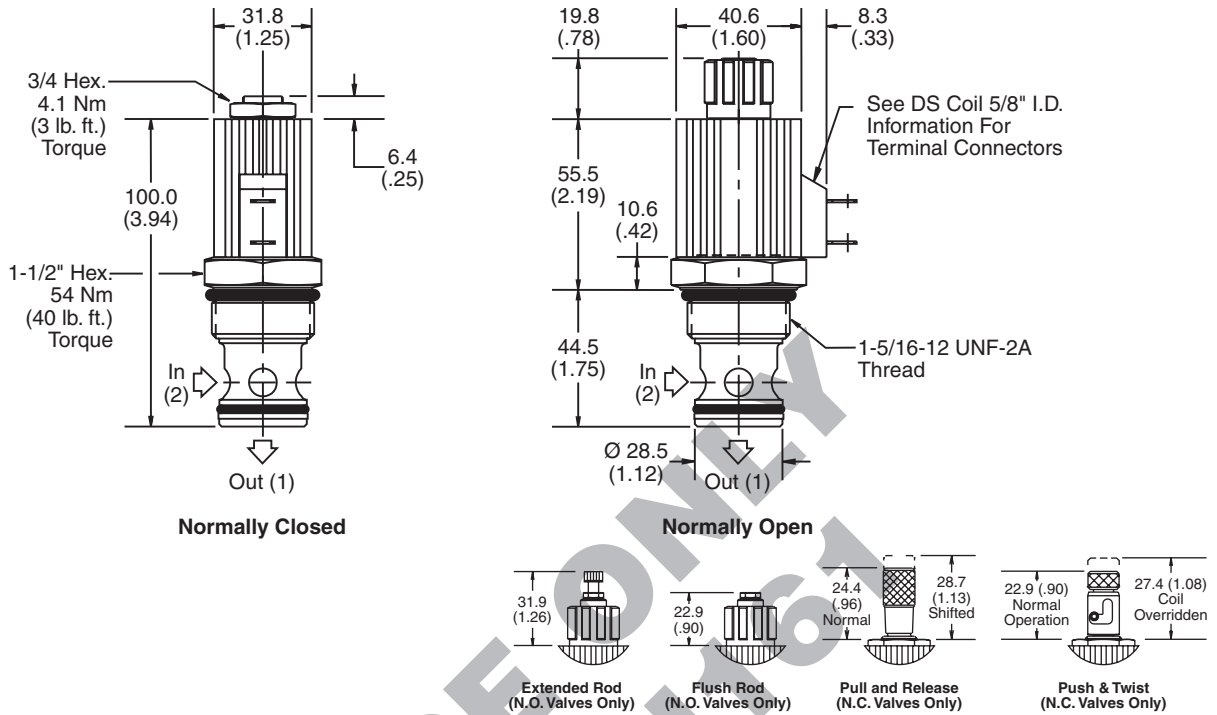

Ordering Information

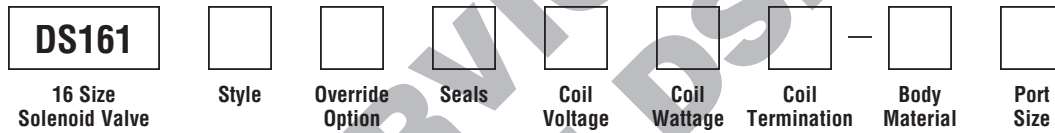

Code / Style	Symbol
C Normally Closed Metered reverse flow	
CH Normally Closed Metered reverse flow (Fast response)	
CR Normally Closed Free reverse flow	
N Normally Open Metered reverse flow	
NR Normally Open Free reverse flow	

Code	Override Options
Omit	None
E	Push Type with Extended Rod (N.O. Only)
M	Push Type with Flush Rod (N.O. Only)
P	Pull & Release (N.C. Only)
T	Push & Twist (N.C. Only)

Code	Seals / Kit. No.
Omit	Nitrile / (SK16-2)
V	Fluorocarbon / (SK16-2V)

Code	Coil Voltage
Omit	Without Coil
D012	12 VDC
D024	24 VDC
A120	120/110 VAC, 60/50 Hz
A240	240/220 VAC, 60/50 Hz

Code	Wattage
Omit	Without Coil
L	17 Watts
H	30 Watts

Code	Coil Termination
Omit	Without Coil
C	Conduit (AC Only)
D	DIN Plug Face
P	Dual Spade (DC Only)
S	Dual Screw (DC Only)
W	Dual Lead (DC Only)

See DS coil 5/8" I.D.

Code	Body Material
Omit	Steel
A	Aluminum

Code	Port Size	Body Part No.
Omit	Cartridge Only	
12T	SAE-12	(B16-2-*12T)
16T	SAE-16	(B16-2-*16T)
12B	3/4" BSPG	(B16-2-*12B)
16B	1" BSPG	(B16-2-16B)†

* Add "A" for aluminum, omit for steel.
 † Steel body only.

Technical Information

- CV** Check Valves
- SH** Shuttle Valves
- LM** Load/Motor Controls
- FC** Flow Controls
- PC** Pressure Controls
- LE** Logic Elements
- DC** Directional Controls
- MV** Manual Valves
- SV** Solenoid Valves
- PV** Proportional Valves
- CE** Coils & Electronics
- BC** Bodies & Cavities
- TD** Technical Data

General Description

2-Way Poppet Valves. For additional information see Technical Tips on pages SV1-SV6.



Features

- Replaceable, one piece encapsulated coils with minimal amperage draw
- Various coil terminations and voltages
- Various manual override options
- All external parts zinc plated
- New 350 Bar (5000 PSI) rating

NOTE:

This valve will be available January 1, 2011.

Specifications

Rated Flow	150 LPM (40 GPM)		
Maximum Inlet Pressure	350 Bar (5000 PSI)		
Leakage at 150 SSU (32 cSt)	5 drops/min. (.33 cc/min.)		
Minimum Operating Voltage	85% of rated voltage at 20°C (72°F).		
Response Time		Energized	De-Energized
	C, CR	50 ms	130 ms
	CH	40 ms	60 ms
	N, NR	45 ms	75 ms
Cartridge Material	All parts steel. All operating parts hardened steel.		
Operating Temp. Range/Seals	-40°C to +93.3°C (Nitrile) (-40°F to +200°F) -31.7°C to +121.1°C (Fluorocarbon) (-25°F to +250°F)		
Fluid Compatibility/ Viscosity	Mineral-based or synthetic with lubricating properties at viscosities of 45 to 2000 SSU (6 to 420 cSt)		
Filtration	ISO Code 16/13, SAE Class 4 or better		
Approx. Weight	.34 kg (.75 lbs.)		
Cavity	C16-2 (See BC Section for more details)		
Form Tool	Rougher Finisher	None	NFT16-2F

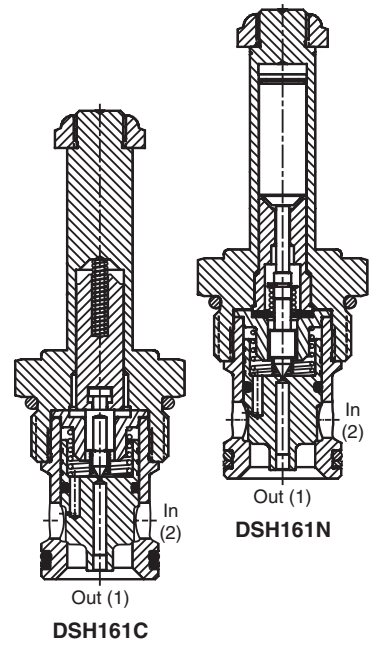
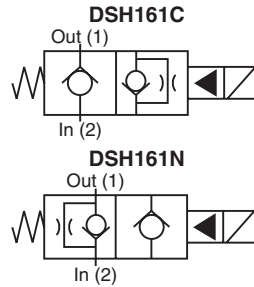

Performance Curves

Pressure Drop vs. Flow (Through cartridge only)

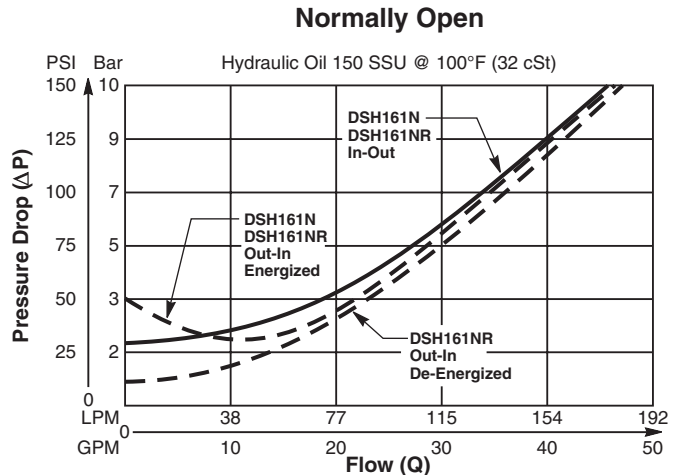
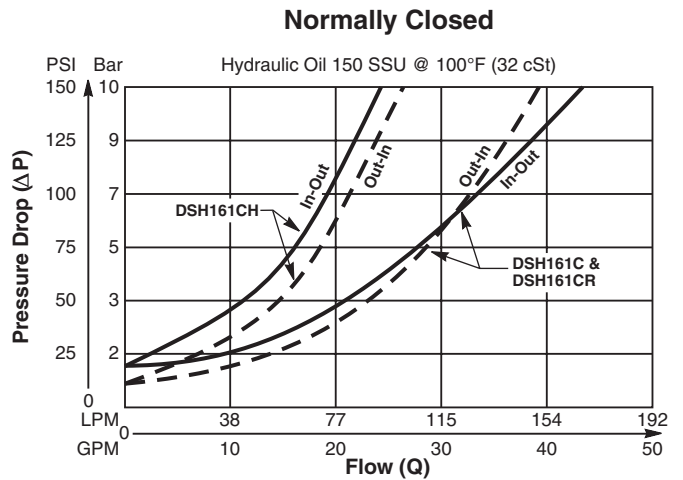

Dimensions Millimeters (Inches)

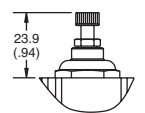
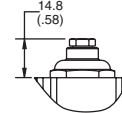
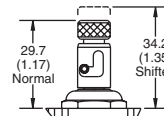
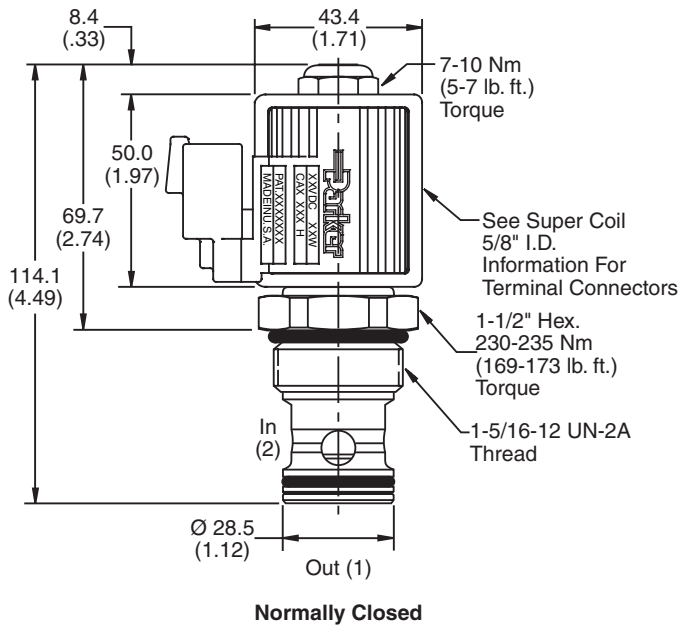

Push and Twist M.O.
 (Normally Closed Valves Only)

Flush M.O.
 (Normally Open Valves Only)

Extended M.O.
 (Normally Open Valves Only)

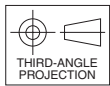

Ordering Information

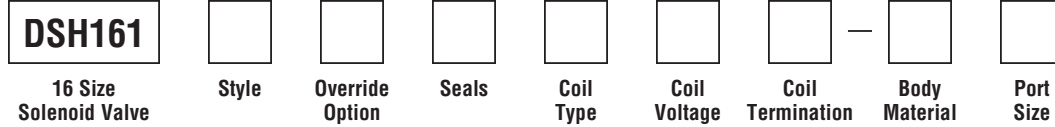

NOTE: This valve will be available January 1, 2011.

Code / Style	Symbol
C Normally Closed Metered reverse flow	
CH Normally Closed Metered reverse flow (Fast response)	
CR Normally Closed Free reverse flow	
N Normally Open Metered reverse flow	
NR Normally Open Free reverse flow	

Code	Override Options
Omit	None
E	Push Type with Extended Rod (N.O. Only)
M	Push Type with Flush Rod (N.O. Only)
T	Push & Twist (N.C. Only)

Code	Seals / Kit. No.
Omit	Nitrile / (SK16-2)
V	Fluorocarbon / (SK16-2V)

Code	Coil Type
Omit	Without Coil
SP*	Super Coil - 28 Watts

**Recommended*

Code	Coil Voltage
Omit	Without Coil
D012	12 VDC
D024	24 VDC
A120	120/110 VAC, 60/50 Hz
A240	240/220 VAC, 60/50 Hz

Code	Body Material
Omit	Steel
A	Aluminum

Code	Port Size	Body Part No.
Omit	Cartridge Only	
12T	SAE-12	(B16-2-*12T)
16T	SAE-16	(B16-2-*16T)
12B	3/4" BSPG	(B16-2-*12B)
16B	1" BSPG	(B16-2-16B)†

** Add "A" for aluminum, omit for steel.
 † Steel body only.*

SP* Coil	Coil Termination
Omit	Without Coil
C	Conduit With Leads
D	DIN Plug Face
A	Amp Jr. Timer†
S	Dual Spade†
L	Dual Lead Wire†
LS	Sealed Lead Wire†
H	Molded Deutsch†

**Recommended †DC Only*



- CV**
Check Valves
- SH**
Shuttle Valves
- LM**
Load/Motor Controls
- FC**
Flow Controls
- PC**
Pressure Controls
- LE**
Logic Elements
- DC**
Directional Controls
- MV**
Manual Valves
- SV**
Solenoid Valves
- PV**
Proportional Valves
- CE**
Coils & Electronics
- BC**
Bodies & Cavities
- TD**
Technical Data

Technical Information

- CV** Check Valves
- SH** Shuttle Valves
- LM** Load/Motor Controls
- FC** Flow Controls
- PC** Pressure Controls
- LE** Logic Elements
- DC** Directional Controls
- MV** Manual Valves
- SV** Solenoid Valves
- PV** Proportional Valves
- CE** Coils & Electronics
- BC** Bodies & Cavities
- TD** Technical Data

General Description

2-Way Poppet Valves. For additional information see Technical Tips on pages SV1-SV6.

Features

- Low hysteresis
- Replaceable, one piece encapsulated coils with minimal amperage draw
- Various coil terminations and voltages
- Various manual override options
- All external parts zinc plated

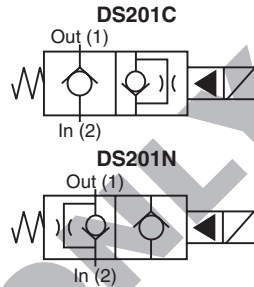
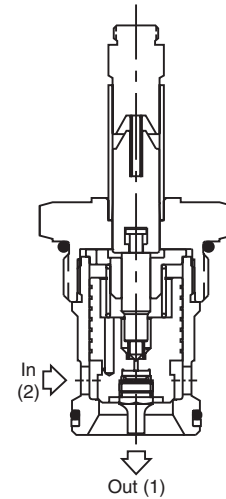
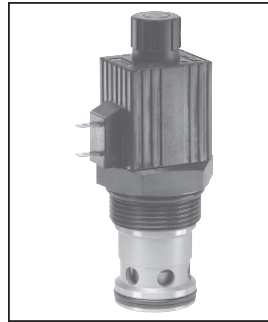

Specifications

Rated Flow (At 70 PSI ΔP)	260 LPM (70 GPM)	
Maximum Inlet Pressure	210 Bar (3000 PSI)	
Leakage at 150 SSU (32 cSt)	20 drops/min. (1.33 cc/min.)	
Minimum Operating Voltage	85% of rated voltage at 20°C (72°F).	
Response Time	Energized	De-Energized
	C, CR N, NR	160 ms 45 ms
		350 ms 300 ms
Cartridge Material	All parts steel. All operating parts hardened steel.	
Operating Temp. Range/Seals	-40°C to +93.3°C (Nitrile) (-40°F to +200°F) -31.7°C to +121.1°C (Fluorocarbon) (-25°F to +250°F)	
Fluid Compatibility/Viscosity	Mineral-based or synthetic with lubricating properties at viscosities of 45 to 2000 SSU (6 to 420 cSt)	
Filtration	ISO Code 16/13, SAE Class 4 or better	
Approx. Weight	.34 kg (.75 lbs.)	
Cavity	C20-2 (See BC Section for more details)	
Form Tool	Rougher Finisher	None NFT20-2F

Performance Curve

Pressure Drop vs. Flow (Through cartridge only)

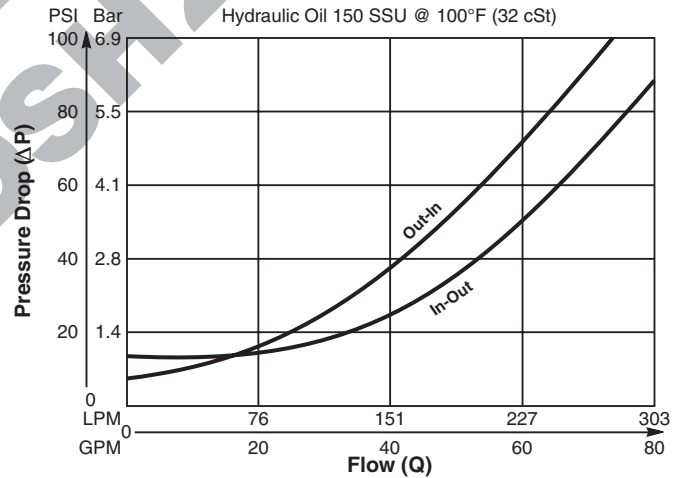

Dimensions Millimeters (Inches)

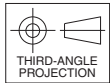
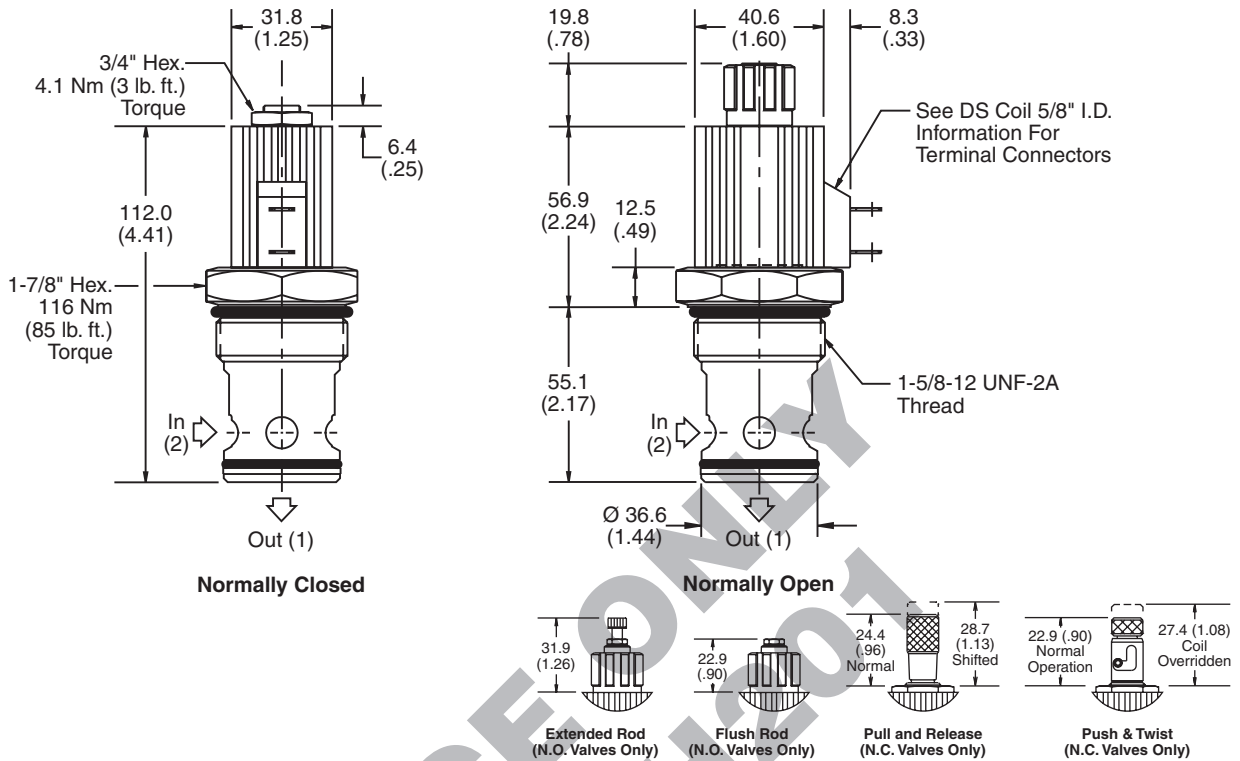

Ordering Information

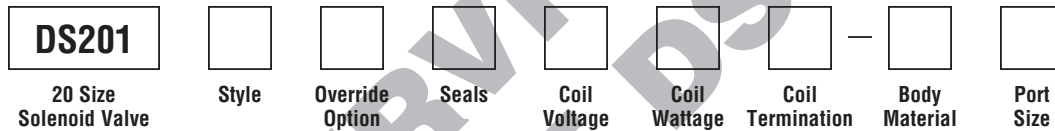

Code / Style	Symbol
C Normally Closed Metered reverse flow	
CR Normally Closed Free reverse flow	
N Normally Open Metered reverse flow	
NR Normally Open Free reverse flow	

Code	Override Options
Omit	None
E	Push Type with Extended Rod (N.O. Only)
M	Push Type with Flush Rod (N.O. Only)
P	Pull & Release (N.C. Only)
T	Push & Twist (N.C. Only)

Code	Wattage
Omit	Without Coil
L	17 Watts
H	30 Watts

Code	Body Material
Omit	Steel

Code	Coil Termination
Omit	Without Coil
C	Conduit (AC Only)
D	DIN Plug Face
P	Dual Spade (DC Only)
S	Dual Screw (DC Only)
W	Dual Lead (DC Only)

Code	Port Size	Body Part No.
Omit	Cartridge Only	
20T	SAE-20	(B20-2-20T)
20B	1-1/4" BSPG	(B20-2-20B)

Code	Seals / Kit. No.
Omit	Nitrile / (SK20-2)
V	Fluorocarbon / (SK20-2V)

Code	Coil Voltage
Omit	Without Coil
D012	12 VDC
D024	24 VDC
A120	120/110 VAC, 60/50 Hz
A240	240/220 VAC, 60/50 Hz

See DS coil 5/8" I.D.

Technical Information

- CV** Check Valves
- SH** Shuttle Valves
- LM** Load/Motor Controls
- FC** Flow Controls
- PC** Pressure Controls
- LE** Logic Elements
- DC** Directional Controls
- MV** Manual Valves
- SV** Solenoid Valves
- PV** Proportional Valves
- CE** Coils & Electronics
- BC** Bodies & Cavities
- TD** Technical Data

General Description

2-Way Poppet Valves. For additional information see Technical Tips on pages SV1-SV6.



Features

- Replaceable, one piece encapsulated coils with minimal amperage draw
- Various coil terminations and voltages
- Various manual override options
- All external parts zinc plated
- New 250 Bar (3600 PSI) rating

NOTE:

This valve will be available January 1, 2011.

Specifications

Rated Flow (At 70 PSI ΔP)	260 LPM (70 GPM)		
Maximum Inlet Pressure	250 Bar (3600 PSI)		
Leakage at 150 SSU (32 cSt)	5 drops/min. (.33 cc/min.)		
Minimum Operating Voltage	85% of rated voltage at 20°C (72°F).		
Response Time		Energized	De-Energized
	C, CR	350 ms	160 ms
	N, NR	300 ms	45 ms
Cartridge Material	All parts steel. All operating parts hardened steel.		
Operating Temp. Range/Seals	-40°C to +93.3°C (Nitrile) (-40°F to +200°F) -31.7°C to +121.1°C (Fluorocarbon) (-25°F to +250°F)		
Fluid Compatibility/Viscosity	Mineral-based or synthetic with lubricating properties at viscosities of 45 to 2000 SSU (6 to 420 cSt)		
Filtration	ISO Code 16/13, SAE Class 4 or better		
Approx. Weight	.34 kg (.75 lbs.)		
Cavity	C20-2 (See BC Section for more details)		
Form Tool	Rougher Finisher	None	NFT20-2F

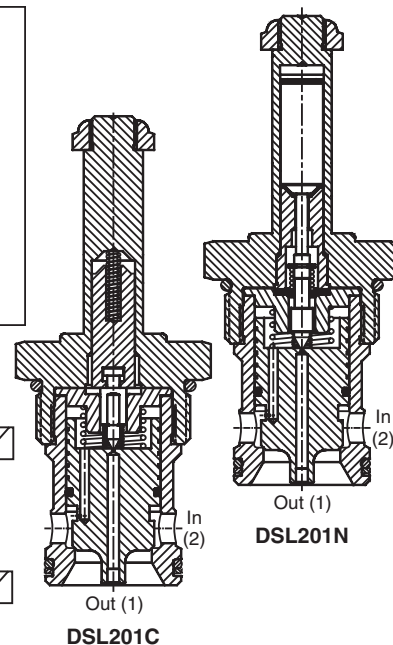
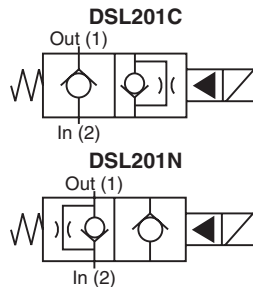

Performance Curve

Pressure Drop vs. Flow (Through cartridge only)

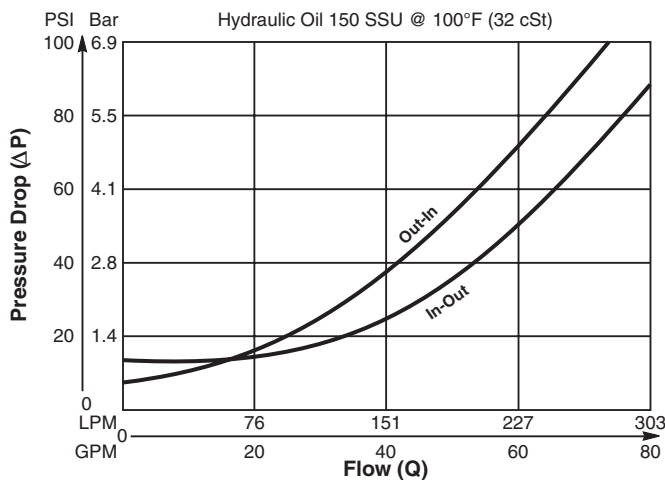

Dimensions Millimeters (Inches)

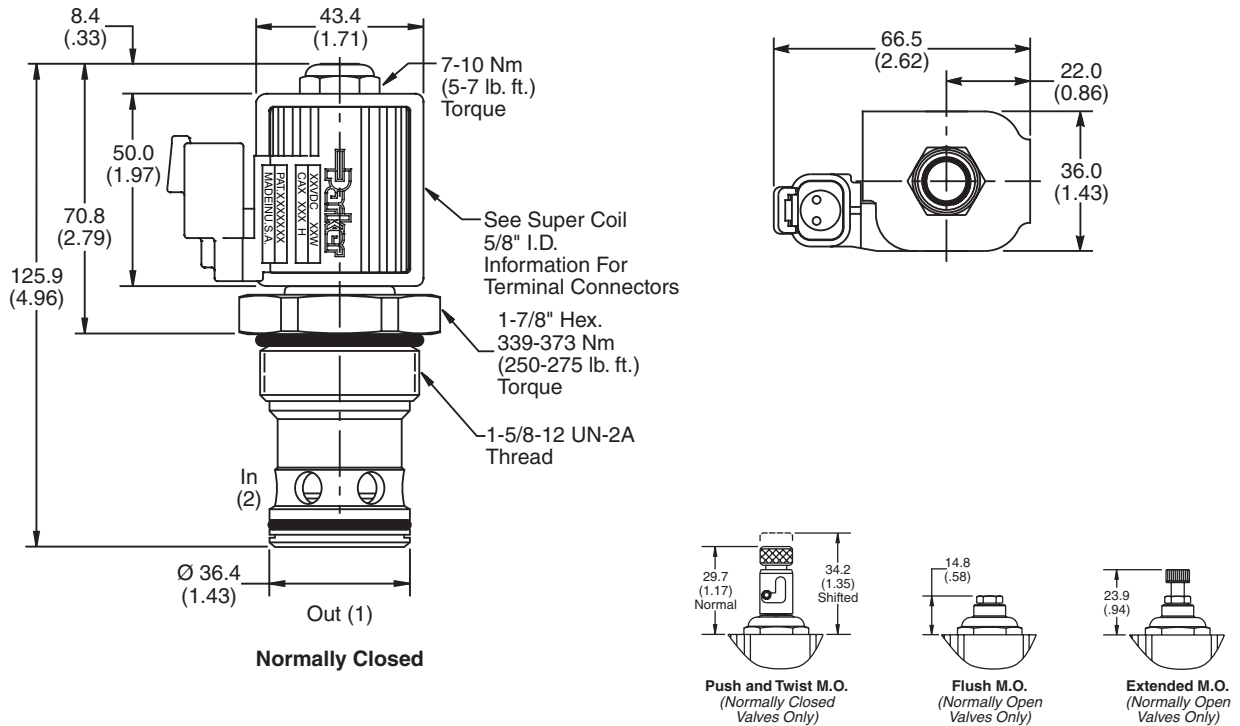

- CV**
Check Valves
- SH**
Shuttle Valves
- LM**
Load/Motor Controls
- FC**
Flow Controls
- PC**
Pressure Controls
- LE**
Logic Elements
- DC**
Directional Controls
- MV**
Manual Valves
- SV**
Solenoid Valves
- PV**
Proportional Valves
- CE**
Coils & Electronics
- BC**
Bodies & Cavities
- TD**
Technical Data

Ordering Information

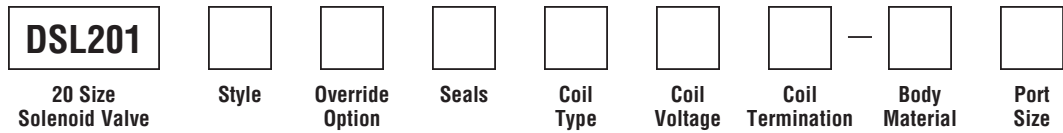

NOTE: This valve will be available January 1, 2011.

Code / Style	Symbol
C Normally Closed Metered reverse flow	
CR Normally Closed Free reverse flow	
N Normally Open Metered reverse flow	
NR Normally Open Free reverse flow	

Code	Override Options
Omit	None
E	Push Type with Extended Rod (N.O. Only)
M	Push Type with Flush Rod (N.O. Only)
T	Push & Twist (N.C. Only)

Code	Seals / Kit. No.
Omit	Nitrile / (SK20-2)
V	Fluorocarbon / (SK20-2V)

Code	Coil Type
Omit	Without Coil
SP*	Super Coil - 28 Watts

**Recommended*

Code	Coil Voltage
Omit	Without Coil
D012	12 VDC
D024	24 VDC
A120	120/110 VAC, 60/50 Hz
A240	240/220 VAC, 60/50 Hz

Code	Body Material
Omit	Steel
A	Aluminum

Code	Port Size	Body Part No.
Omit	Cartridge Only	
20T	SAE-20	(B20-2-*20T)
20B	1-1/4" BSPG	(B20-2-*20B)

** Add "A" for aluminum, omit for steel.*

SP* Coil	Coil Termination
Omit	Without Coil
C	Conduit With Leads
D	DIN Plug Face
A	Amp Jr. Timer†
S	Dual Spade†
L	Dual Lead Wire†
LS	Sealed Lead Wire†
H	Molded Deutsch†

**Recommended †DC Only*



Technical Information

- CV** Check Valves
- SH** Shuttle Valves
- LM** Load/Motor Controls
- FC** Flow Controls
- PC** Pressure Controls
- LE** Logic Elements
- DC** Directional Controls
- MV** Manual Valves
- SV** Solenoid Valves
- PV** Proportional Valves
- CE** Coils & Electronics
- BC** Bodies & Cavities
- TD** Technical Data

General Description

2-Way, 2 Position, Normally Closed Poppet Valve With Flow Control Adjustment. This valve maintains constant flow at $\Delta P \geq 20$ Bar (300 PSI) regardless of load pressure changes upstream of the valve at port 2.

Features

- Light weight alloy housing with hardened steel moving parts
- One piece cartridge housing ensures internal concentricity
- Coil: Waterproof, hermetically sealed, requires no O’Rings; Coil is interchangeable with 04 and 06 series poppet valves; Symmetrical coil can be reversed without affecting performance.

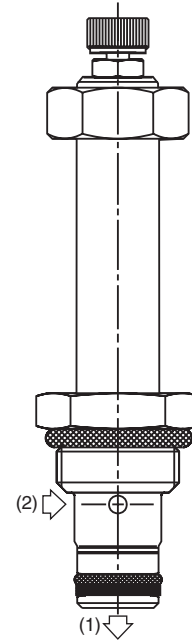
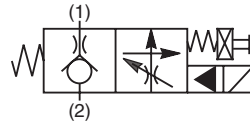

Specifications

Rated Flow (At 70 PSI ΔP)	9.5 LPM (2.5 GPM)
Maximum Inlet Pressure	High Pressure 285 Bar (4000 PSI)
Leakage at 150 SSU (32 cSt)	5 drops/min. (.33 cc/min.)
Minimum Operating Voltage	85% of rated voltage at 20°C (72°F).
Response Time	Open 20 ms Close 25 ms
Cartridge Material	All parts steel. All operating parts hardened steel.
Operating Temp. Range/Seals	-40°C to +93.3°C (Nitrile) (-40°F to +200°F) -31.7°C to +121.1°C (Fluorocarbon) (-25°F to +250°F)
Fluid Compatibility/ Viscosity	Mineral-based or synthetic with lubricating properties at viscosities of 45 to 2000 SSU (6 to 420 cSt)
Filtration	ISO Code 16/13, SAE Class 4 or better
Approx. Weight	.09 kg (.19 lbs.)
Cavity	C08-2 (See BC Section for more details)

Performance Curves

(Through cartridge only)

Pressure Compensation For Different Flow Settings

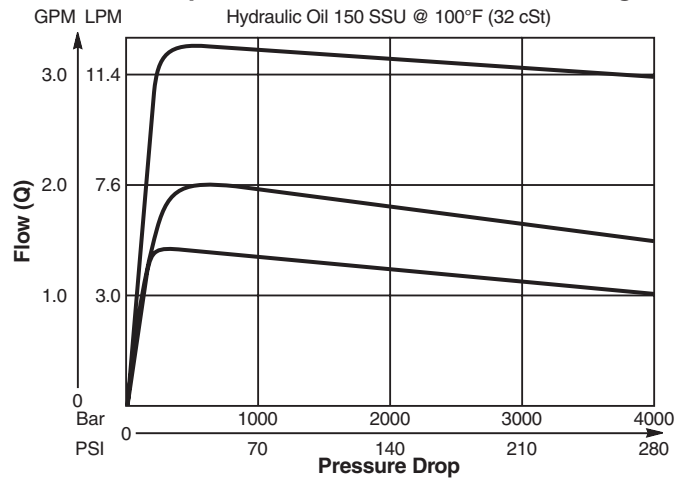

Reverse Flow

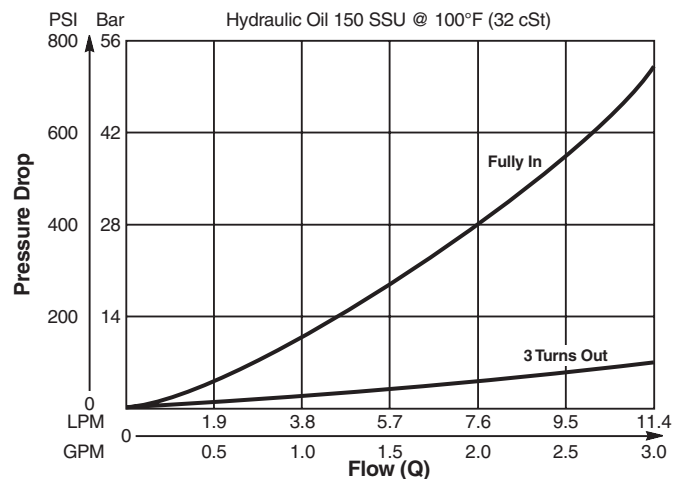

Technical Information

Dimensions Millimeters (Inches)

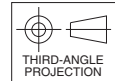
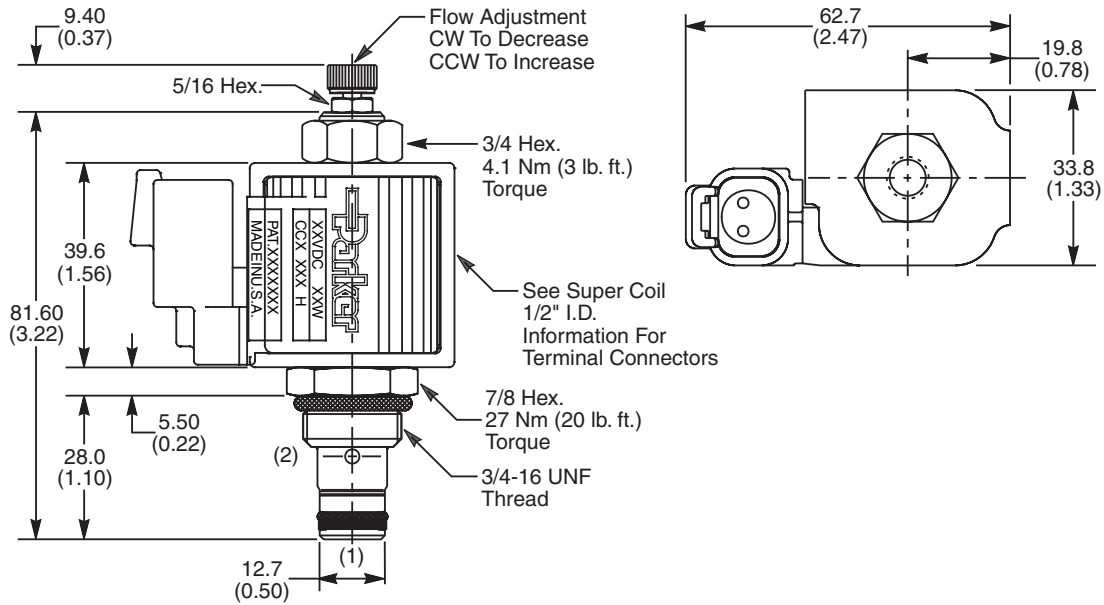

Ordering Information

GH02	01								
08 Size Solenoid Valve	Style Normally Closed	Screen	Seals	Coil Type	Coil Voltage	Coil Termination	Body Material	Port Size	

Code	Style
01	High Pressure ('SP' Coil)

Code	Screen
0	None
1	60 Mesh Screen

Code	Seals / Kit No.
N	Nitrile / Buna-N (Std.) (SK30006N-1)
V	Fluorocarbon / (SK30006V-1)

Code	Coil Type
Omit	Without Coil
SP	Super Coil - 19 Watts

Code	Coil Voltage
Omit	Without Coil
D012	12 VDC
D024	24 VDC
A120	120 VAC, 60/50 Hz
A240	240 VAC, 60/50 Hz*

*22 Watts

Code	Coil Termination
Omit	Without Coil
C	Conduit With Leads
D	DIN Plug Face
A	Amp Jr. Timer*
S	Dual Spade*
L	Dual Lead Wire*
LS	Sealed Lead Wire*
H	Molded Deutsch*

See Super Coil 1/2" I.D.
*DC Only

Code	Body Material
Omit	Steel
A	Aluminum

Code	Port Size	Body Part No.
Omit		Cartridge Only
6T	SAE-6	(B08-2-*6T)
6B	3/8" BSPG	(B08-2-*6B)

* Add "A" for aluminum, omit for steel.

- CV
Check Valves
- SH
Shuttle Valves
- LM
Load/Motor Controls
- FC
Flow Controls
- PC
Pressure Controls
- LE
Logic Elements
- DC
Directional Controls
- MV
Manual Valves
- SV
Solenoid Valves
- PV
Proportional Valves
- CE
Coils & Electronics
- BC
Bodies & Cavities
- TD
Technical Data

Technical Information

- CV** Check Valves
- SH** Shuttle Valves
- LM** Load/Motor Controls
- FC** Flow Controls
- PC** Pressure Controls
- LE** Logic Elements
- DC** Directional Controls
- MV** Manual Valves
- SV** Solenoid Valves
- PV** Proportional Valves
- CE** Coils & Electronics
- BC** Bodies & Cavities
- TD** Technical Data

General Description

2-Way, 2 Position, Normally Closed Poppet Valve. Bi-Directional Direct Acting. For additional information see Technical Tips on pages SV1-SV6.

Features

- Fast Response
- One piece cartridge housing ensures internal concentricity
- Coil: Waterproof, hermetically sealed, requires no O’Rings; Coil is interchangeable with 04 and 06 series poppet valves; Symmetrical coil can be reversed without affecting performance.

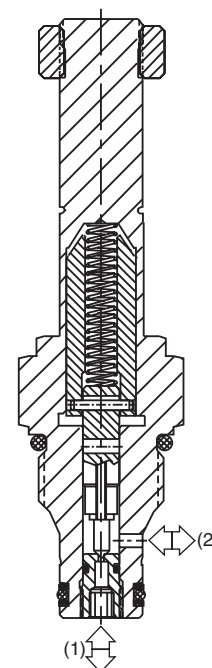
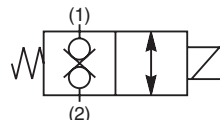
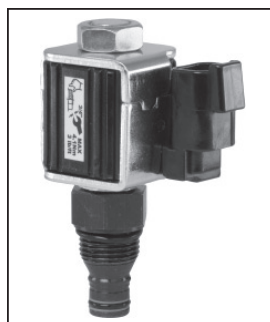

Specifications

Rated Flow (At 70 PSI ΔP)	1 LPM (0.26 GPM)
Maximum Inlet Pressure	210 Bar (3000 PSI)
Leakage at 150 SSU (32 cSt)	72 5 drops/min. (.33 cc/min.) 73 Zero Drops Soft (Delrin) Seat
Minimum Operating Voltage	85% of rated voltage at 20°C (72°F).
Response Time	Open 10 ms Close 10 ms
Cartridge Material	All parts steel. All operating parts hardened steel.
Operating Temp. Range/Seals	-40°C to +93.3°C (Nitrile) (-40°F to +200°F) -31.7°C to +121.1°C (Fluorocarbon) (-25°F to +250°F)
Fluid Compatibility/ Viscosity	Mineral-based or synthetic with lubricating properties at viscosities of 45 to 2000 SSU (6 to 420 cSt)
Filtration	ISO Code 16/13, SAE Class 4 or better
Approx. Weight	.14 kg (.31 lbs.)
Cavity	C08-2 (See BC Section for more details)

Performance Curve

Pressure Drop vs. Flow (Through cartridge only)

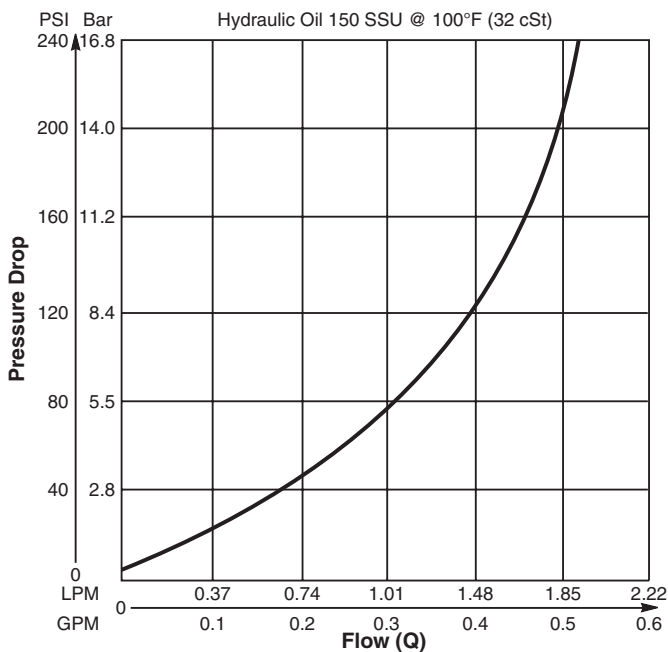

Technical Information

Dimensions Millimeters (Inches)

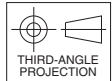
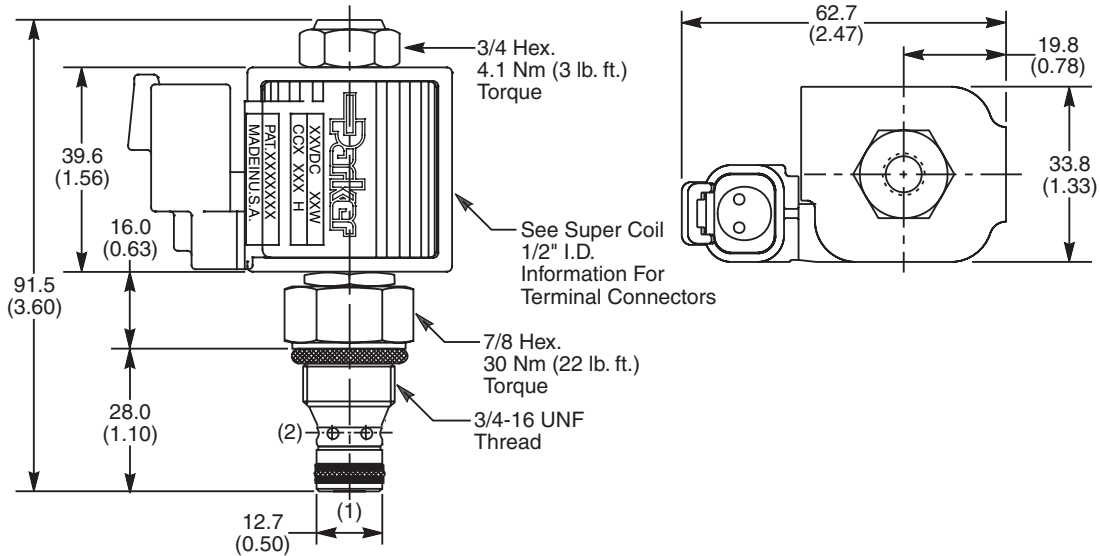

Ordering Information

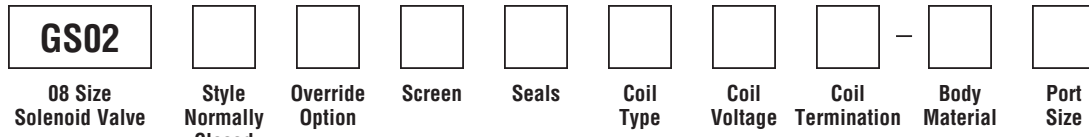

Code	Style
72	Standard ('SP' Coil)
73	Zero Drops ('SP' Coil)

Code	Override Options
0	None

Code	Screen
0	None
1	60 Mesh Screen

Code	Seals / Kit No.
N	Nitrile / Buna-N (Std.) (SK30088N-1)
V	Fluorocarbon / (SK30088V-1)

Code	Coil Type
Omit	Without Coil
SP	Super Coil - 19 Watts

Code	Coil Voltage
Omit	Without Coil
D012	12 VDC
D024	24 VDC
A120	120 VAC, 60/50 Hz
A240	240 VAC, 60/50 Hz*

*22 Watts

Code	Coil Termination
Omit	Without Coil
C	Conduit With Leads
D	DIN Plug Face
A	Amp Jr. Timer*
S	Dual Spade*
L	Dual Lead Wire*
LS	Sealed Lead Wire*
H	Molded Deutsch*

See Super Coil 1/2" I.D.
*DC Only

Code	Body Material
Omit	Steel
A	Aluminum

Code	Port Size	Body Part No.
Omit	Cartridge Only	
6T	SAE-6	(B08-2-*6T)
6B	3/8" BSPG	(B08-2-*6B)

* Add "A" for aluminum, omit for steel.



- CV
Check Valves
- SH
Shuttle Valves
- LM
Load/Motor Controls
- FC
Flow Controls
- PC
Pressure Controls
- LE
Logic Elements
- DC
Directional Controls
- MV
Manual Valves
- SV
Solenoid Valves
- PV
Proportional Valves
- CE
Coils & Electronics
- BC
Bodies & Cavities
- TD
Technical Data

Technical Information

- CV** Check Valves
- SH** Shuttle Valves
- LM** Load/Motor Controls
- FC** Flow Controls
- PC** Pressure Controls
- LE** Logic Elements
- DC** Directional Controls
- MV** Manual Valves
- SV** Solenoid Valves
- PV** Proportional Valves
- CE** Coils & Electronics
- BC** Bodies & Cavities
- TD** Technical Data

General Description

2-Way, 2 Position, Normally Closed, Bi-Directional Poppet Valve. For additional information see Technical Tips on pages SV1-SV6.

Features

- Built-in thermal relief set at 36 Bar (500 PSI) above rated pressure
- One piece cartridge housing ensures internal concentricity
- Coil: Waterproof, hermetically sealed, requires no O’Rings; Coil is interchangeable with 04 and 06 series poppet valves; Symmetrical coil can be reversed without affecting performance.

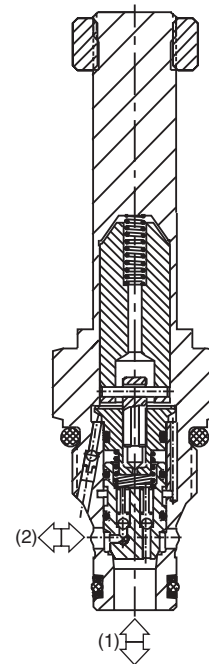
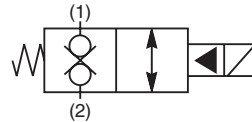

Specifications

Rated Flow (At 70 PSI ΔP)	2 to 1 34 LPM (9 GPM) 1 to 2 19 LPM (5 GPM)
Maximum Inlet Pressure	80 210 Bar (3000 PSI) 81 350 Bar (5000 PSI)
Leakage at 150 SSU (32 cSt)	5 drops/min. (.33 cc/min.)
Minimum Operating Voltage	85% of rated voltage at 20°C (72°F).
Response Time	Open 40 ms Close 40 ms
Cartridge Material	All parts steel. All operating parts hardened steel.
Operating Temp. Range/Seals	-40°C to +93.3°C (Nitrile) (-40°F to +200°F) -31.7°C to +121.1°C (Fluorocarbon) (-25°F to +250°F)
Fluid Compatibility/ Viscosity	Mineral-based or synthetic with lubricating properties at viscosities of 45 to 2000 SSU (6 to 420 cSt)
Filtration	ISO Code 16/13, SAE Class 4 or better
Approx. Weight	.14 kg (.31 lbs.)
Cavity	C08-2 (See BC Section for more details)

Performance Curve

Pressure Drop vs. Flow (Through cartridge only)

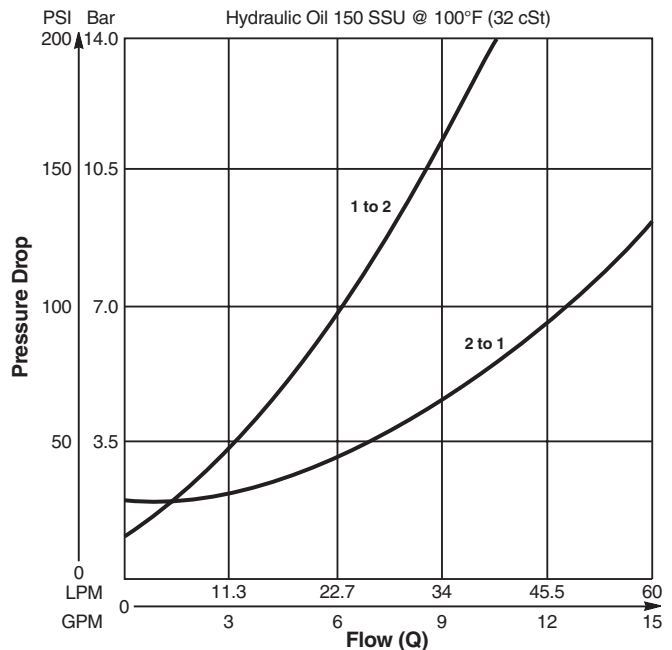

Technical Information

Dimensions Millimeters (Inches)

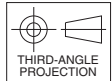
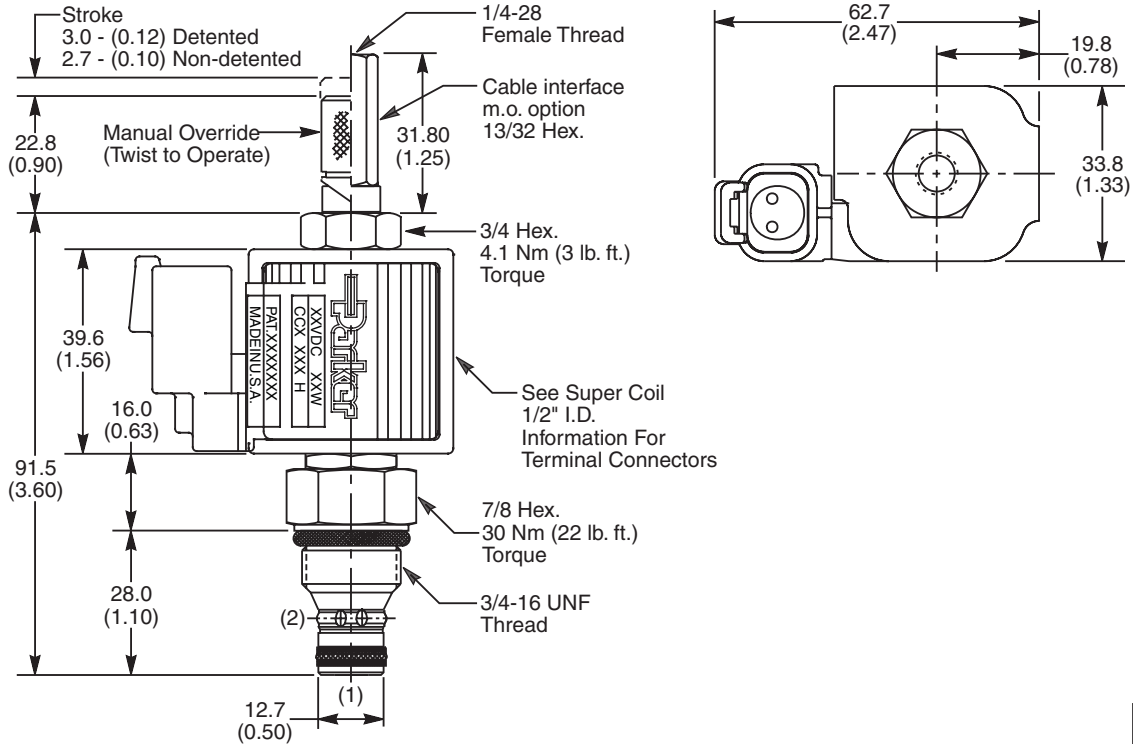

Ordering Information

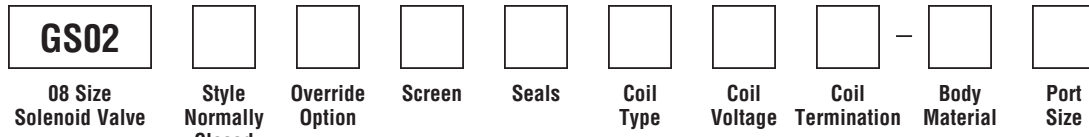

Code	Style
80	Standard ('SS' Coil)
81	High Pressure ('SP' Coil)

Code	Seals / Kit No.
N	Nitrile / Buna-N (Std.) (SK30088N-1)

Code	Coil Termination
Omit	Without Coil
C	Conduit With Leads
D	DIN Plug Face
A	Amp Jr. Timer*
S	Dual Spade*
L	Dual Lead Wire*
LS	Sealed Lead Wire*
H	Molded Deutsch*

Code	Body Material
Omit	Steel
A	Aluminum

Code	Override Options
0	None
1	Detented
2	Non-Detented
3	Cable Interface 210 Bar (3000 PSI)

Code	Coil Type
Omit	Without Coil
SS	Super Coil - 14 Watts
SP	Super Coil - 19 Watts

Code	Port Size	Body Part No.
Omit	Cartridge Only	
6T	SAE-6	(B08-2-*6T)
6B	3/8" BSPG	(B08-2-*6B)

Code	Coil Voltage
Omit	Without Coil
D012	12 VDC
D024	24 VDC
A120	120 VAC, 60/50 Hz
A240	240 VAC, 60/50 Hz*

*22 Watts

See Super Coil 1/2" I.D.
*DC Only

* Add "A" for aluminum, omit for steel.

Code	Screen
0	None
1	60 Mesh Screen

- CV Check Valves
- SH Shuttle Valves
- LM Load/Motor Controls
- FC Flow Controls
- PC Pressure Controls
- LE Logic Elements
- DC Directional Controls
- MV Manual Valves
- SV Solenoid Valves
- PV Proportional Valves
- CE Coils & Electronics
- BC Bodies & Cavities
- TD Technical Data



Technical Information

- CV** Check Valves
- SH** Shuttle Valves
- LM** Load/Motor Controls
- FC** Flow Controls
- PC** Pressure Controls
- LE** Logic Elements
- DC** Directional Controls
- MV** Manual Valves
- SV** Solenoid Valves
- PV** Proportional Valves
- CE** Coils & Electronics
- BC** Bodies & Cavities
- TD** Technical Data

General Description

2-Way, 2 Position, Normally Closed, Bi-Directional Poppet Valve. For additional information see Technical Tips on pages SV1-SV6.

Features

- Built-in thermal relief set at 36 Bar (500 PSI) above rated pressure
- One piece cartridge housing ensures internal concentricity
- Coil: Waterproof, hermetically sealed, requires no O’Rings; Coil is interchangeable with 02 and 06 series poppet valves; Symmetrical coil can be reversed without affecting performance.

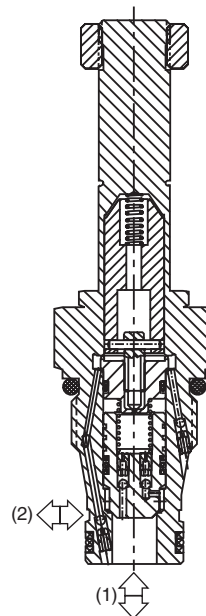
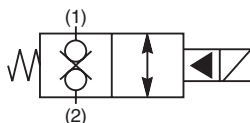

Specifications

Rated Flow (At 70 PSI ΔP)	2 to 1 68 LPM (18 GPM) 1 to 2 46 LPM (12 GPM)
Maximum Inlet Pressure	80 210 Bar (3000 PSI) 81 350 Bar (5000 PSI)
Leakage at 150 SSU (32 cSt)	5 drops/min. (.33 cc/min.)
Minimum Operating Voltage	85% of rated voltage at 20°C (72°F).
Response Time	See Performance Curves
Cartridge Material	All parts steel. All operating parts hardened steel.
Operating Temp. Range/Seals	-40°C to +93.3°C (Nitrile) (-40°F to +200°F) -31.7°C to +121.1°C (Fluorocarbon) (-25°F to +250°F)
Fluid Compatibility/Viscosity	Mineral-based or synthetic with lubricating properties at viscosities of 45 to 2000 SSU (6 to 420 cSt)
Filtration	ISO Code 16/13, SAE Class 4 or better
Approx. Weight	.17 kg (.37 lbs.)
Cavity	2R (See BC Section for more details)

Performance Curves

Pressure Drop vs. Flow (Through cartridge only)

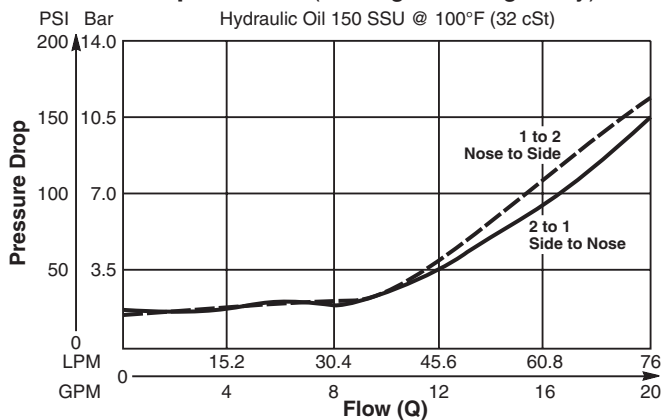

Response Time vs. Flow

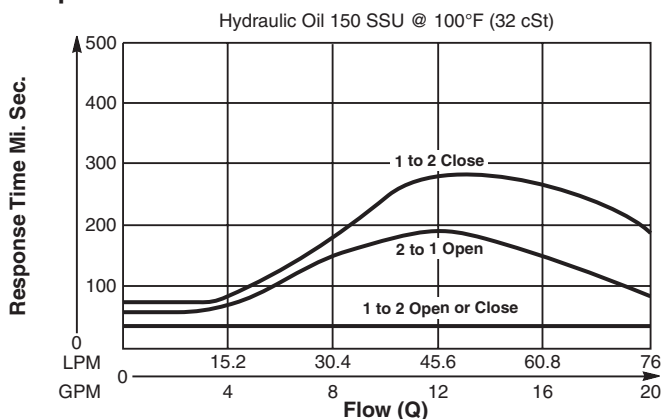

Technical Information

Dimensions Millimeters (Inches)

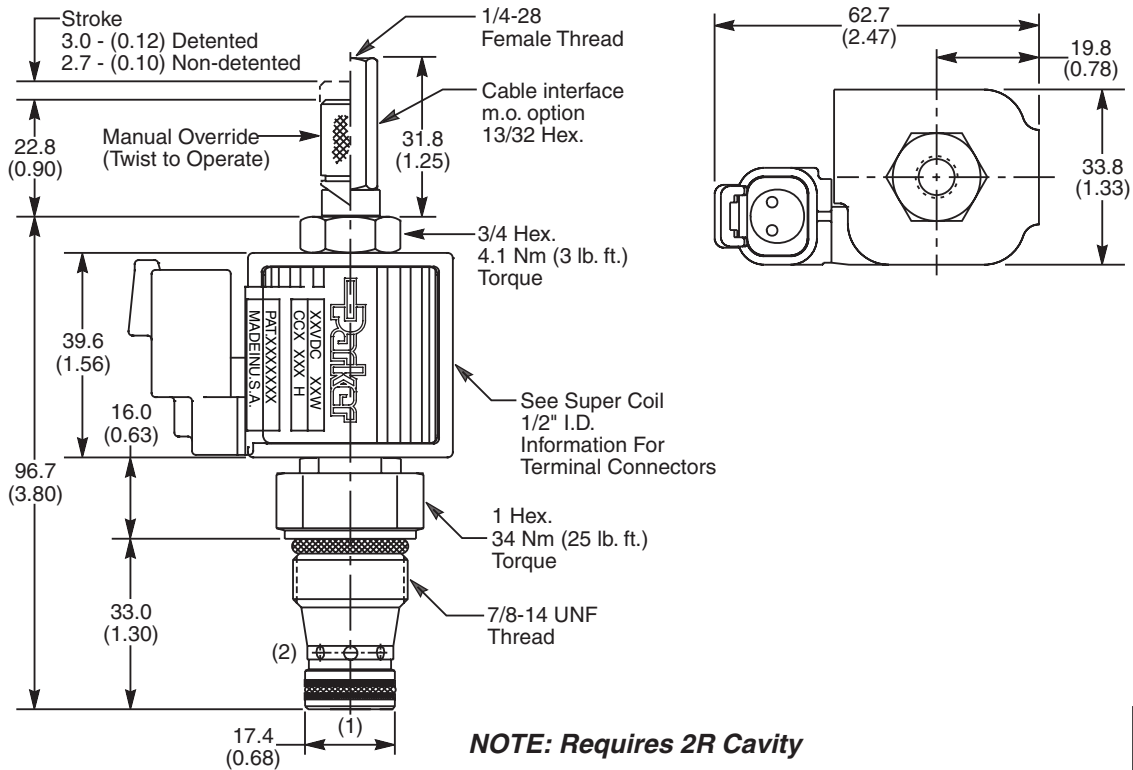

Ordering Information

GS04

10 Size Solenoid Valve Style Normally Closed Override Option Screen Seals Coil Type Coil Voltage Coil Termination

Code	Style
80	Standard ('SS' Coil)
81	High Pressure ('SP' Coil)

Code	Seals / Kit No.
N	Nitrile / Buna-N (Std.) (SK30113N-1)

Code	Coil Termination
Omit	Without Coil
C	Conduit With Leads
D	DIN Plug Face
A	Amp Jr. Timer*
S	Dual Spade*
L	Dual Lead Wire*
LS	Sealed Lead Wire*
H	Molded Deutsch*

See Super Coil 1/2" I.D.
*DC Only

Code	Override Options
0	None
1	Detented
2	Non-Detented
3	Cable Interface 210 Bar (3000 PSI)

Code	Coil Type
Omit	Without Coil
SS	Super Coil - 14 Watts
SP	Super Coil - 19 Watts

Code	Coil Voltage
Omit	Without Coil
D012	12 VDC
D024	24 VDC
A120	120 VAC, 60/50 Hz
A240	240 VAC, 60/50 Hz*

*22 Watts

Code	Screen
0	None

Order Bodies Separately

LB10

Line Body Porting Body Material

Code	Porting
543	1/2" SAE
545	1/2" BSP

Code	Body Material
A	Aluminum
S	Steel

- CV Check Valves
- SH Shuttle Valves
- LM Load/Motor Controls
- FC Flow Controls
- PC Pressure Controls
- LE Logic Elements
- DC Directional Controls
- MV Manual Valves
- SV Solenoid Valves
- PV Proportional Valves
- CE Coils & Electronics
- BC Bodies & Cavities
- TD Technical Data

Technical Information

- CV** Check Valves
- SH** Shuttle Valves
- LM** Load/Motor Controls
- FC** Flow Controls
- PC** Pressure Controls
- LE** Logic Elements
- DC** Directional Controls
- MV** Manual Valves
- SV** Solenoid Valves
- PV** Proportional Valves
- CE** Coils & Electronics
- BC** Bodies & Cavities
- TD** Technical Data

General Description

2-Way, 2 Position, Normally Closed, Bi-Directional Poppet Valve. For additional information see Technical Tips on pages SV1-SV6.

Features

- Built-in thermal relief set at 36 Bar (500 PSI) above rated pressure
- One piece cartridge housing ensures internal concentricity
- Coil: Waterproof, hermetically sealed, requires no O’Rings; Coil is interchangeable with 02 and 04 series poppet valves; Symmetrical coil can be reversed without affecting performance.

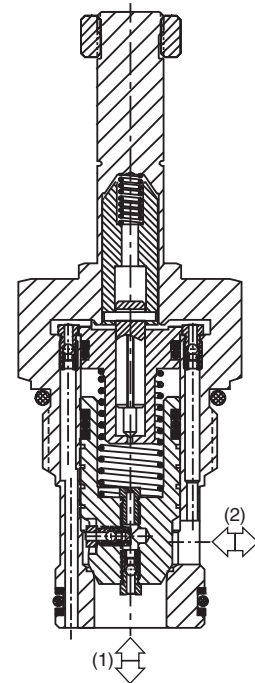
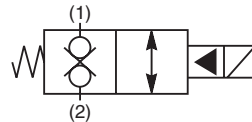

Specifications

Rated Flow (At 70 PSI ΔP)	190 LPM (50 GPM)
Maximum Inlet Pressure	80 210 Bar (3000 PSI) 81 350 Bar (5000 PSI)
Leakage at 150 SSU (32 cSt)	9 drops/min. (.58 cc/min.)
Minimum Operating Voltage	85% of rated voltage at 20°C (72°F).
Response Time	See Performance Curves
Cartridge Material	All parts steel. All operating parts hardened steel.
Operating Temp. Range/Seals	-40°C to +93.3°C (Nitrile) (-40°F to +200°F) -31.7°C to +121.1°C (Fluorocarbon) (-25°F to +250°F)
Fluid Compatibility/ Viscosity	Mineral-based or synthetic with lubricating properties at viscosities of 45 to 2000 SSU (6 to 420 cSt)
Filtration	ISO Code 16/13, SAE Class 4 or better
Approx. Weight	0.4 kg (.88 lbs.)
Cavity	C16-2 (See BC Section for more details)

Performance Curves

Pressure Drop vs. Flow (Through cartridge only)

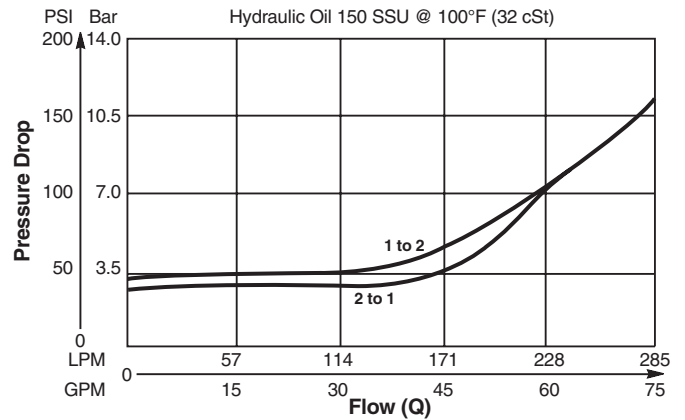

Response Time vs. Flow

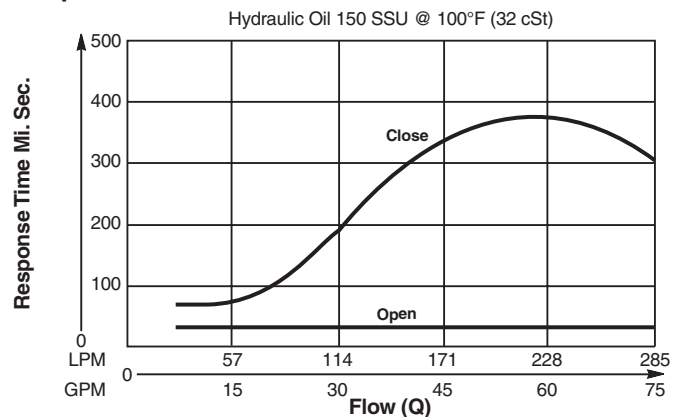

Technical Information

Dimensions Millimeters (Inches)

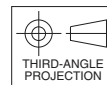
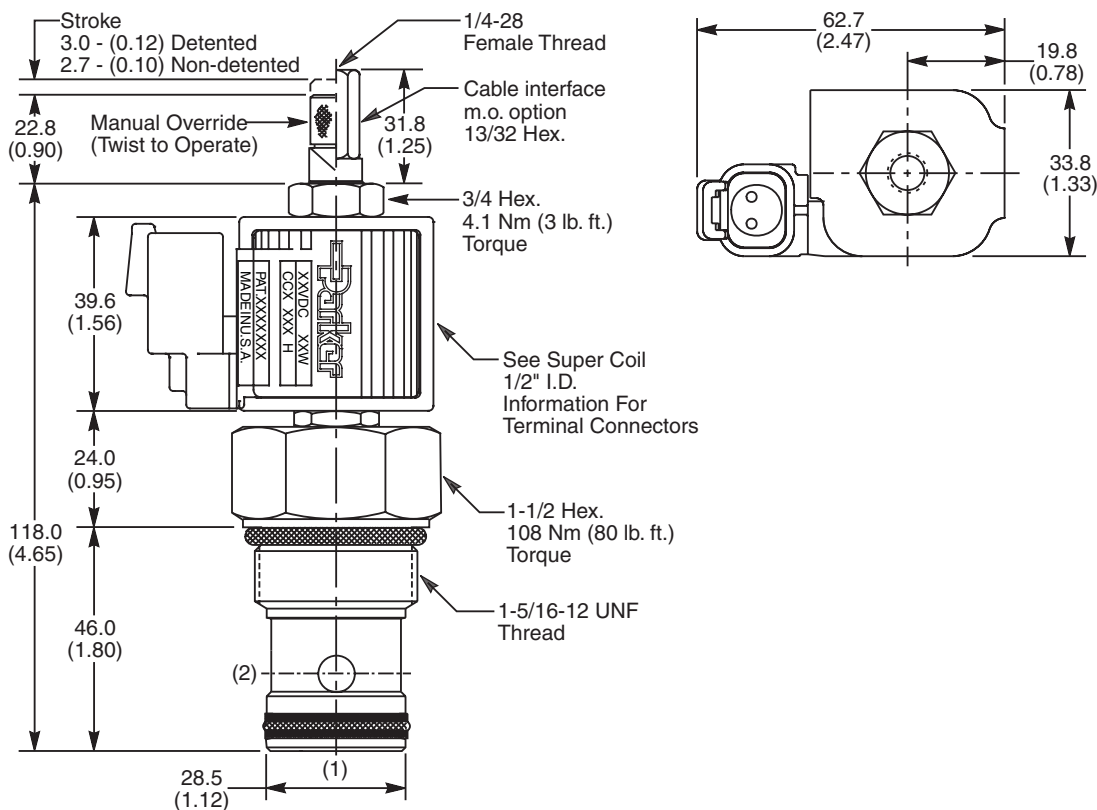

Ordering Information

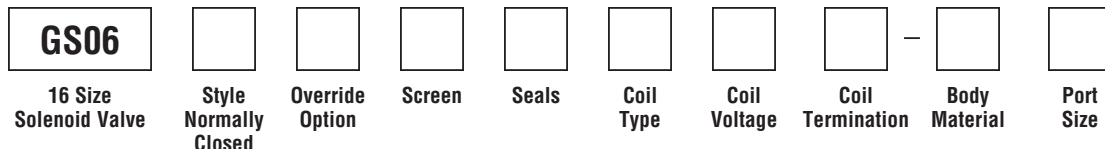

Code	Style
80	Standard ('SS' Coil)
81	High Pressure ('SP' Coil)

Code	Seals / Kit No.
N	Nitrile / Buna-N (Std.) (SK30089N-1)
V	Fluorocarbon / (SK30089V-1)

Code	Coil Termination
Omit	Without Coil
C	Conduit With Leads
D	DIN Plug Face
A	Amp Jr. Timer*
S	Dual Spade*
L	Dual Lead Wire*
LS	Sealed Lead Wire*
H	Molded Deutsch*

Code	Body Material
Omit	Steel
A	Aluminum

Code	Override Options
0	None
1	Detented
2	Non-Detented
3	Cable Interface 210 Bar (3000 PSI)

Code	Coil Type
Omit	Without Coil
SS	Super Coil - 14 Watts
SP	Super Coil - 19 Watts

Code	Port Size	Body Part No.
Omit	Cartridge Only	
16T	SAE-16	(B16-2-*16T)
16B	1" BSPG	(B16-2-16B)†

* Add "A" for aluminum, omit for steel.
† Steel body only.

Code	Screen
0	None

Code	Coil Voltage
Omit	Without Coil
D012	12 VDC
D024	24 VDC
A120	120 VAC, 60/50 Hz
A240	240 VAC, 60/50 Hz*

*22 Watts

See Super Coil 1/2" I.D.
*DC Only



- CV Check Valves
- SH Shuttle Valves
- LM Load/Motor Controls
- FC Flow Controls
- PC Pressure Controls
- LE Logic Elements
- DC Directional Controls
- MV Manual Valves
- SV Solenoid Valves
- PV Proportional Valves
- CE Coils & Electronics
- BC Bodies & Cavities
- TD Technical Data

Technical Information

- CV** Check Valves
- SH** Shuttle Valves
- LM** Load/Motor Controls
- FC** Flow Controls
- PC** Pressure Controls
- LE** Logic Elements
- DC** Directional Controls
- MV** Manual Valves
- SV** Solenoid Valves
- PV** Proportional Valves
- CE** Coils & Electronics
- BC** Bodies & Cavities
- TD** Technical Data

General Description

2-Way, 2 Position, Normally Open Poppet Valve. Bi-Directional Direct Acting. For additional information see Technical Tips on pages SV1-SV6.

Features

- Fast Response
- One piece cartridge housing ensures internal concentricity
- Coil: Waterproof, hermetically sealed, requires no O’Rings; Coil is interchangeable with 04 and 06 series poppet valves; Symmetrical coil can be reversed without affecting performance.

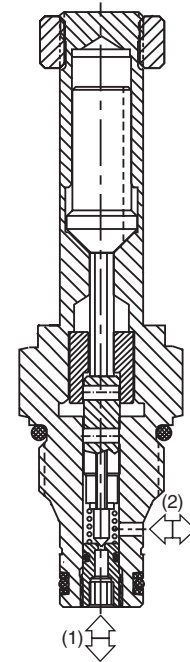
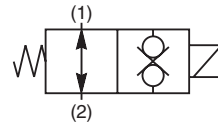

Specifications

Rated Flow (At 70 PSI ΔP)	1 LPM (0.26 GPM)
Maximum Inlet Pressure	210 Bar (3000 PSI)
Leakage at 150 SSU (32 cSt)	77 5 drops/min. (.33 cc/min.) 78 Zero Drops Soft (Delrin) Seat
Minimum Operating Voltage	85% of rated voltage at 20°C (72°F).
Response Time	Open 10 ms Close 10 ms
Cartridge Material	All parts steel. All operating parts hardened steel.
Operating Temp. Range/Seals	-40°C to +93.3°C (Nitrile) (-40°F to +200°F) -31.7°C to +121.1°C (Fluorocarbon) (-25°F to +250°F)
Fluid Compatibility/ Viscosity	Mineral-based or synthetic with lubricating properties at viscosities of 45 to 2000 SSU (6 to 420 cSt)
Filtration	ISO Code 16/13, SAE Class 4 or better
Approx. Weight	.14 kg (.31 lbs.)
Cavity	C08-2 (See BC Section for more details)

Performance Curve

Pressure Drop vs. Flow (Through cartridge only)

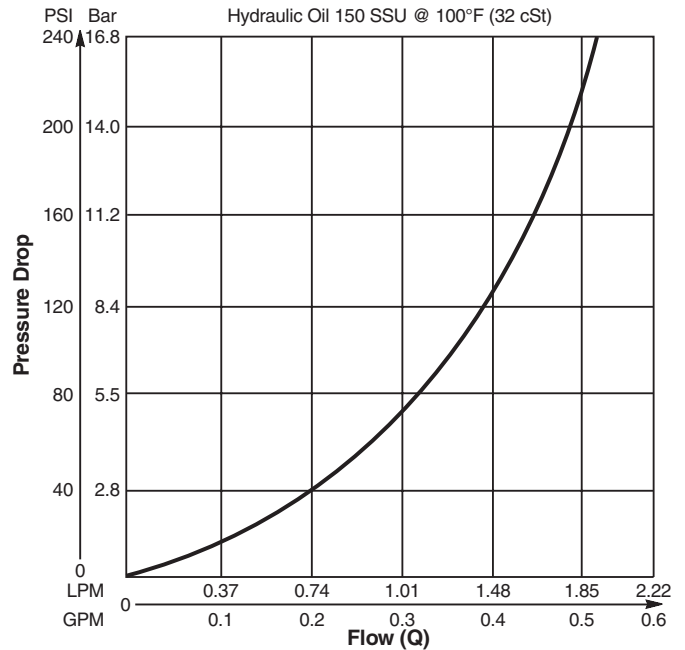

Technical Information

Dimensions Millimeters (Inches)

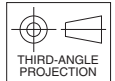
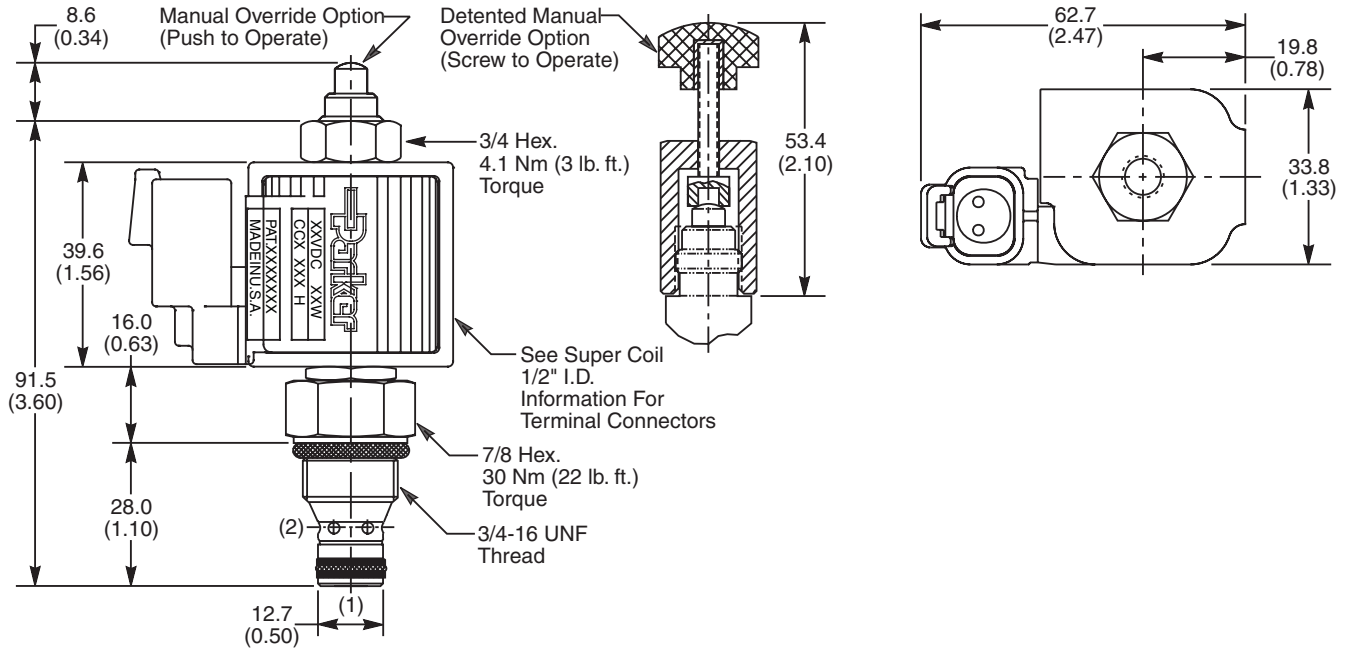

Ordering Information

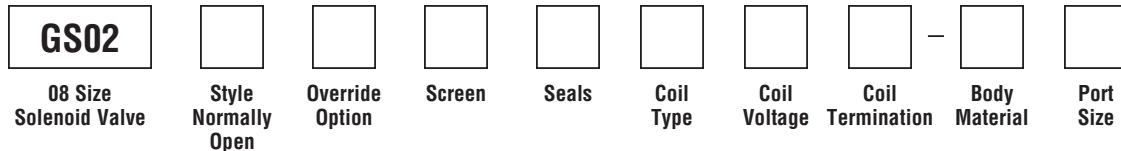

Code	Style
77	Standard ('SP' Coil)
78	Zero Drops ('SP' Coil)

Code	Seals / Kit No.
N	Nitrile / Buna-N (Std.) (SK30088N-1)
V	Fluorocarbon / (SK30088V-1)

Code	Coil Termination
Omit	Without Coil
C	Conduit With Leads
D	DIN Plug Face
A	Amp Jr. Timer*
S	Dual Spade*
L	Dual Lead Wire*
LS	Sealed Lead Wire*
H	Molded Deutsch*

Code	Body Material
Omit	Steel
A	Aluminum

Code	Override Options
0	None
1	Manual Override
2	Detented Part No. 900690

Code	Coil Type
Omit	Without Coil
SP	Super Coil - 19 Watts

Code	Port Size	Body Part No.
Omit	Cartridge Only	
6T	SAE-6	(B08-2-*6T)
6B	3/8" BSPG	(B08-2-*6B)

* Add "A" for aluminum, omit for steel.

Code	Screen
0	None
1	60 Mesh Screen

Code	Coil Voltage
Omit	Without Coil
D012	12 VDC
D024	24 VDC
A120	120 VAC, 60/50 Hz
A240	240 VAC, 60/50 Hz*

*22 Watts

See Super Coil 1/2" I.D.
*DC Only



- CV Check Valves
- SH Shuttle Valves
- LM Load/Motor Controls
- FC Flow Controls
- PC Pressure Controls
- LE Logic Elements
- DC Directional Controls
- MV Manual Valves
- SV Solenoid Valves
- PV Proportional Valves
- CE Coils & Electronics
- BC Bodies & Cavities
- TD Technical Data

Technical Information

- CV** Check Valves
- SH** Shuttle Valves
- LM** Load/Motor Controls
- FC** Flow Controls
- PC** Pressure Controls
- LE** Logic Elements
- DC** Directional Controls
- MV** Manual Valves
- SV** Solenoid Valves
- PV** Proportional Valves
- CE** Coils & Electronics
- BC** Bodies & Cavities
- TD** Technical Data

General Description

2-Way, 2 Position, Normally Open, Bi-Directional Poppet Valve. For additional information see Technical Tips on pages SV1-SV6.

Features

- Built-in thermal relief set at 36 Bar (500 PSI) above rated pressure
- One piece cartridge housing ensures internal concentricity
- Coil: Waterproof, hermetically sealed, requires no O’Rings; Coil is interchangeable with 04 and 06 series poppet valves; Symmetrical coil can be reversed without affecting performance.

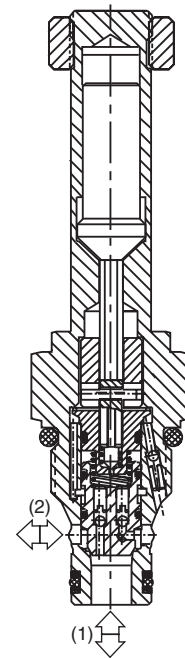
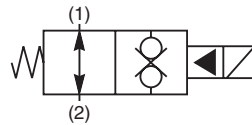

Specifications

Rated Flow (At 70 PSI ΔP)	2 to 1 34 LPM (9 GPM) 1 to 2 19 LPM (5 GPM)
Maximum Inlet Pressure	85 210 Bar (3000 PSI) 86 350 Bar (5000 PSI)
Leakage at 150 SSU (32 cSt)	5 drops/min. (.33 cc/min.)
Minimum Operating Voltage	85% of rated voltage at 20°C (72°F).
Response Time	Open 40 ms Close 40 ms
Cartridge Material	All parts steel. All operating parts hardened steel.
Operating Temp. Range/Seals	-40°C to +93.3°C (Nitrile) (-40°F to +200°F) -31.7°C to +121.1°C (Fluorocarbon) (-25°F to +250°F)
Fluid Compatibility/ Viscosity	Mineral-based or synthetic with lubricating properties at viscosities of 45 to 2000 SSU (6 to 420 cSt)
Filtration	ISO Code 16/13, SAE Class 4 or better
Approx. Weight	.14 kg (.31 lbs.)
Cavity	C08-2 (See BC Section for more details)

Performance Curve

Pressure Drop vs. Flow (Through cartridge only)

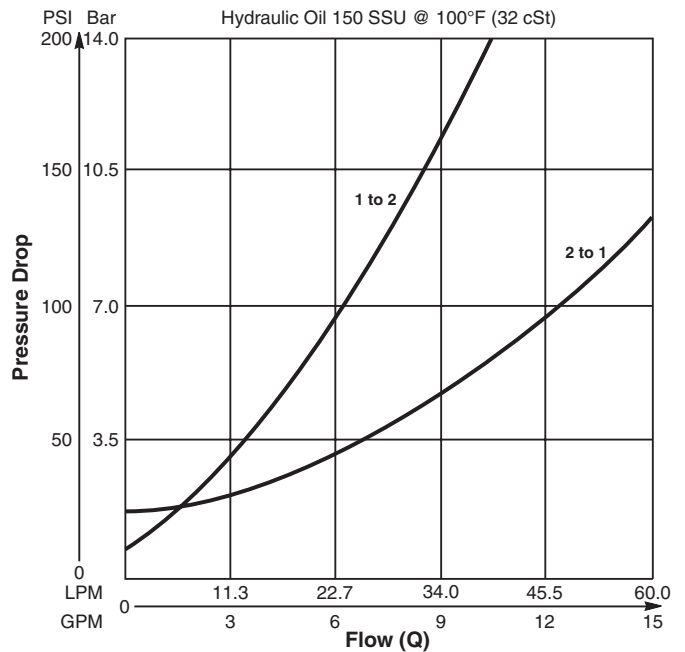

Technical Information

Dimensions Millimeters (Inches)

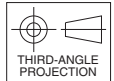
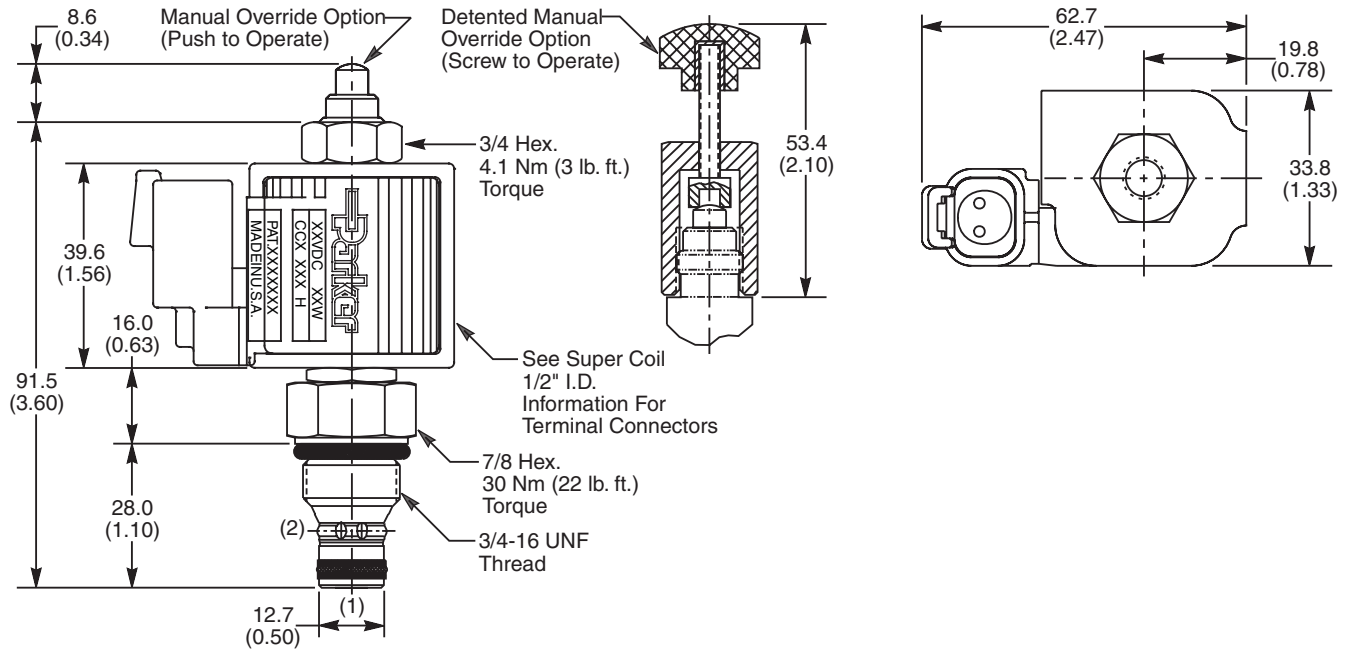

Ordering Information

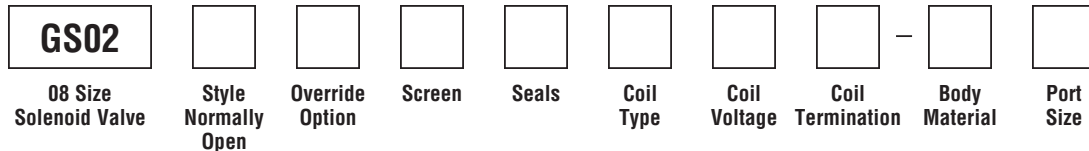

Code	Style
85	Standard ('SS' Coil)
86	High Pressure ('SP' Coil)

Code	Seals / Kit No.
N	Nitrile / Buna-N (Std.) (SK30088N-1)

Code	Coil Termination
Omit	Without Coil
C	Conduit With Leads
D	DIN Plug Face
A	Amp Jr. Timer*
S	Dual Spade*
L	Dual Lead Wire*
LS	Sealed Lead Wire*
H	Molded Deutsch*

Code	Body Material
Omit	Steel
A	Aluminum

Code	Override Options
0	None
1	Manual Override
2	Detented Part No. 900690

Code	Coil Type
Omit	Without Coil
SS	Super Coil - 14 Watts
SP	Super Coil - 19 Watts

Code	Port Size	Body Part No.
Omit	Cartridge Only	
6T	SAE-6	(B08-2-*6T)
6B	3/8" BSPG	(B08-2-*6B)

* Add "A" for aluminum, omit for steel.

Code	Screen
0	None

Code	Coil Voltage
Omit	Without Coil
D012	12 VDC
D024	24 VDC
A120	120 VAC, 60/50 Hz
A240	240 VAC, 60/50 Hz*

*22 Watts

See Super Coil 1/2" I.D.
*DC Only

- CV Check Valves
- SH Shuttle Valves
- LM Load/Motor Controls
- FC Flow Controls
- PC Pressure Controls
- LE Logic Elements
- DC Directional Controls
- MV Manual Valves
- SV Solenoid Valves
- PV Proportional Valves
- CE Coils & Electronics
- BC Bodies & Cavities
- TD Technical Data

Technical Information

- CV** Check Valves
- SH** Shuttle Valves
- LM** Load/Motor Controls
- FC** Flow Controls
- PC** Pressure Controls
- LE** Logic Elements
- DC** Directional Controls
- MV** Manual Valves
- SV** Solenoid Valves
- PV** Proportional Valves
- CE** Coils & Electronics
- BC** Bodies & Cavities
- TD** Technical Data

General Description

2-Way, 2 Position, Normally Open, Bi-Directional Poppet Valve. For additional information see Technical Tips on pages SV1-SV6.

Features

- Built-in thermal relief set at 36 Bar (500 PSI) above rated pressure
- One piece cartridge housing ensures internal concentricity
- Coil: Waterproof, hermetically sealed, requires no O’Rings; Coil is interchangeable with 02 and 06 series poppet valves; Symmetrical coil can be reversed without affecting performance.

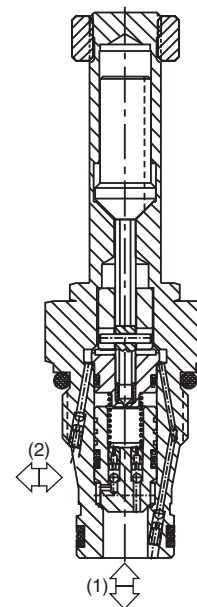
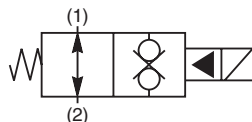

Specifications

Rated Flow (At 70 PSI ΔP)	2 to 1 68 LPM (18 GPM) 1 to 2 46 LPM (12 GPM)
Maximum Inlet Pressure	85 210 Bar (3000 PSI) 86 350 Bar (5000 PSI)
Leakage at 150 SSU (32 cSt)	5 drops/min. (.33 cc/min.)
Minimum Operating Voltage	85% of rated voltage at 20°C (72°F).
Response Time	See Performance Curves
Cartridge Material	All parts steel. All operating parts hardened steel.
Operating Temp. Range/Seals	-40°C to +93.3°C (Nitrile) (-40°F to +200°F) -31.7°C to +121.1°C (Fluorocarbon) (-25°F to +250°F)
Fluid Compatibility/Viscosity	Mineral-based or synthetic with lubricating properties at viscosities of 45 to 2000 SSU (6 to 420 cSt)
Filtration	ISO Code 16/13, SAE Class 4 or better
Approx. Weight	.17 kg (.37 lbs.)
Cavity	2R (See BC Section for more details)

Performance Curves

Pressure Drop vs. Flow (Through cartridge only)

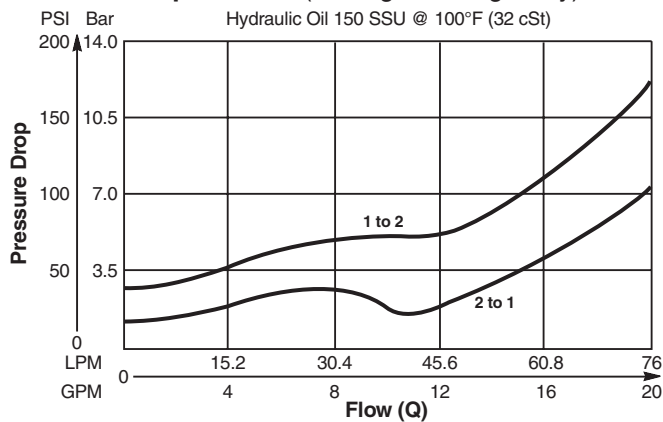

Response Time vs. Flow

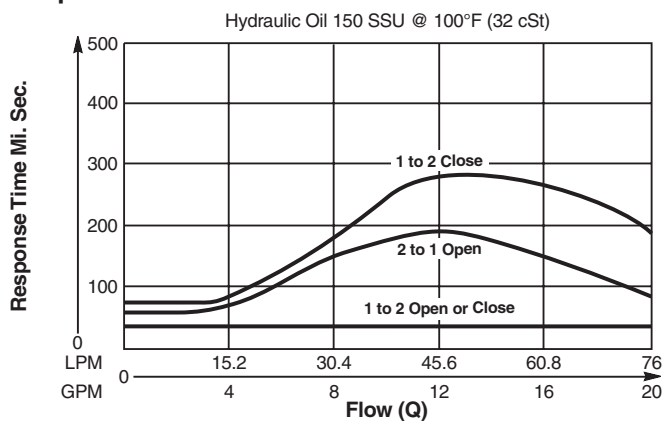

Technical Information

Dimensions Millimeters (Inches)

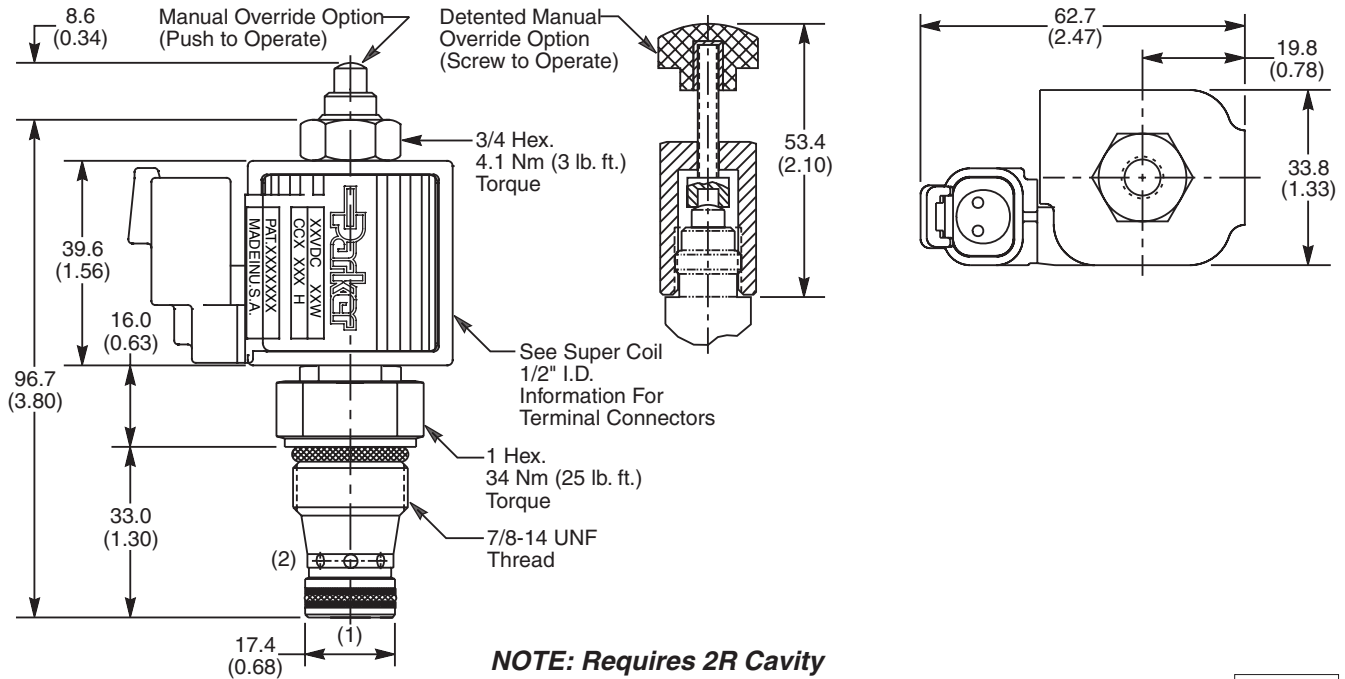

Ordering Information

GS04							
10 Size Solenoid Valve	Style Normally Open	Override Option	Screen	Seals	Coil Type	Coil Voltage	Coil Termination

Code	Style
85	Standard ('SS' Coil)
86	High Pressure ('SP' Coil)

Code	Seals / Kit No.
N	Nitrile / Buna-N (Std.) (SK30113N-1)

Code	Coil Termination
Omit	Without Coil
C	Conduit With Leads
D	DIN Plug Face
A	Amp Jr. Timer*
S	Dual Spade*
L	Dual Lead Wire*
LS	Sealed Lead Wire*
H	Molded Deutsch*

See Super Coil 1/2" I.D.
*DC Only

Code	Override Options
0	None
1	Manual Override
2	Detented Part No. 900690

Code	Coil Type
Omit	Without Coil
SS	Super Coil - 14 Watts
SP	Super Coil - 19 Watts

Code	Coil Voltage
Omit	Without Coil
D012	12 VDC
D024	24 VDC
A120	120 VAC, 60/50 Hz
A240	240 VAC, 60/50 Hz*

*22 Watts

Code	Screen
0	None

Order Bodies Separately

LB10		
Line Body	Porting	Body Material

Code	Porting
543	1/2" SAE
545	1/2" BSP

Code	Body Material
A	Aluminum
S	Steel



- CV Check Valves
- SH Shuttle Valves
- LM Load/Motor Controls
- FC Flow Controls
- PC Pressure Controls
- LE Logic Elements
- DC Directional Controls
- MV Manual Valves
- SV Solenoid Valves
- PV Proportional Valves
- CE Coils & Electronics
- BC Bodies & Cavities
- TD Technical Data

Technical Information

- CV** Check Valves
- SH** Shuttle Valves
- LM** Load/Motor Controls
- FC** Flow Controls
- PC** Pressure Controls
- LE** Logic Elements
- DC** Directional Controls
- MV** Manual Valves
- SV** Solenoid Valves
- PV** Proportional Valves
- CE** Coils & Electronics
- BC** Bodies & Cavities
- TD** Technical Data

General Description

2-Way, 2 Position, Normally Open, Bi-Directional Poppet Valve. For additional information see Technical Tips on pages SV1-SV6.

Features

- Built-in thermal relief set at 36 Bar (500 PSI) above rated pressure
- One piece cartridge housing ensures internal concentricity
- Coil: Waterproof, hermetically sealed, requires no O’Rings; Coil is interchangeable with 02 and 04 series poppet valves; Symmetrical coil can be reversed without affecting performance.

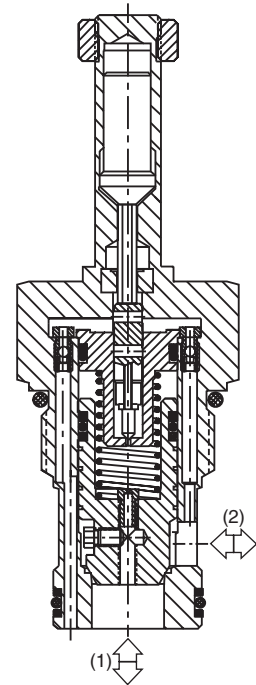
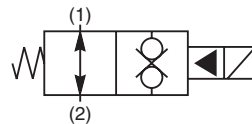

Specifications

Rated Flow (At 70 PSI ΔP)	190 LPM (50 GPM)
Maximum Inlet Pressure	85 210 Bar (3000 PSI) 86 350 Bar (5000 PSI)
Leakage at 150 SSU (32 cSt)	5 drops/min. (.33 cc/min.)
Minimum Operating Voltage	85% of rated voltage at 20°C (72°F).
Response Time	See Performance Curves
Cartridge Material	All parts steel. All operating parts hardened steel.
Operating Temp. Range/Seals	-40°C to +93.3°C (Nitrile) (-40°F to +200°F) -31.7°C to +121.1°C (Fluorocarbon) (-25°F to +250°F)
Fluid Compatibility/ Viscosity	Mineral-based or synthetic with lubricating properties at viscosities of 45 to 2000 SSU (6 to 420 cSt)
Filtration	ISO Code 16/13, SAE Class 4 or better
Approx. Weight	0.4 kg (.88 lbs.)
Cavity	C16-2 (See BC Section for more details)

Performance Curves

Pressure Drop vs. Flow (Through cartridge only)

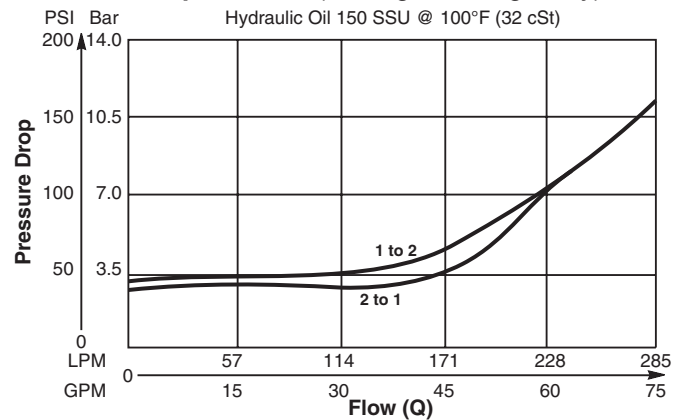

Response Time vs. Flow

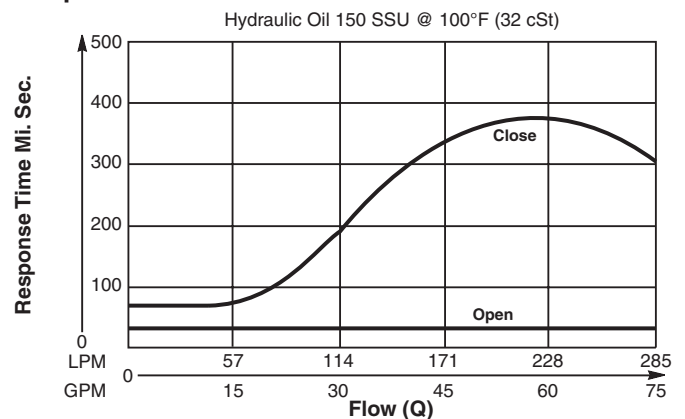

Technical Information

Dimensions Millimeters (Inches)

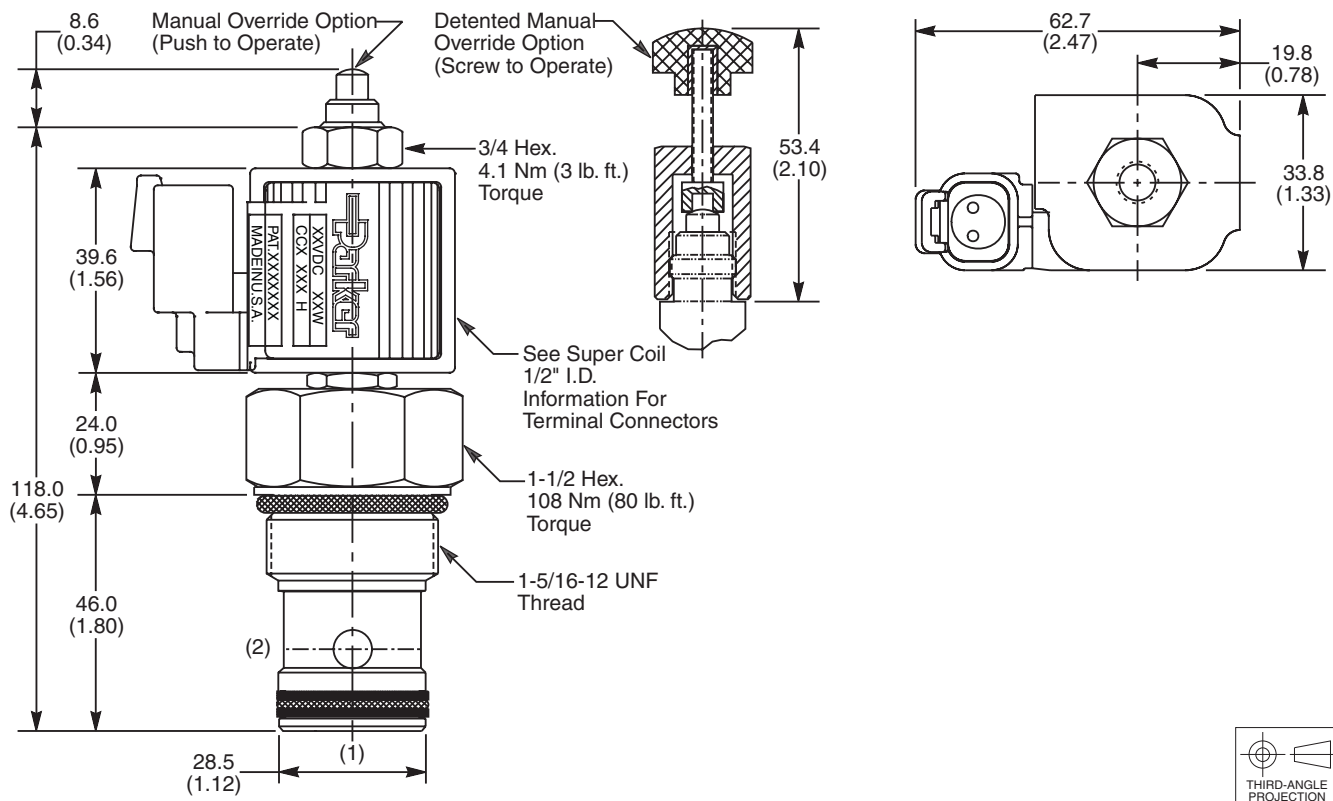

Ordering Information

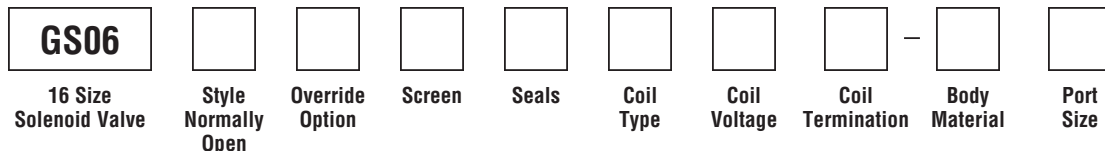

Code	Style
85	Standard ('SS' Coil)
86	High Pressure ('SP' Coil)

Code	Override Options
0	None
1	Manual Override
2	Detented Part No. 900690

Code	Screen
0	None

Code	Seals / Kit No.
N	Nitrile / Buna-N (Std.) (SK30089N-1)
V	Fluorocarbon / (SK30089V-1)

Code	Coil Type
Omit	Without Coil
SS	Super Coil - 14 Watts
SP	Super Coil - 19 Watts

Code	Coil Voltage
Omit	Without Coil
D012	12 VDC
D024	24 VDC
A120	120 VAC, 60/50 Hz
A240	240 VAC, 60/50 Hz*

*22 Watts

Code	Coil Termination
Omit	Without Coil
C	Conduit With Leads
D	DIN Plug Face
A	Amp Jr. Timer*
S	Dual Spade*
L	Dual Lead Wire*
LS	Sealed Lead Wire*
H	Molded Deutsch*

See Super Coil 1/2" I.D.
*DC Only

Code	Body Material
Omit	Steel
A	Aluminum

Code	Port Size	Body Part No.
Omit	Cartridge Only	
16T	SAE-16	(B16-2-*16T)
16B	1" BSPG	(B16-2-16B)†

* Add "A" for aluminum, omit for steel.
† Steel body only.

- CV Check Valves
- SH Shuttle Valves
- LM Load/Motor Controls
- FC Flow Controls
- PC Pressure Controls
- LE Logic Elements
- DC Directional Controls
- MV Manual Valves
- SV Solenoid Valves
- PV Proportional Valves
- CE Coils & Electronics
- BC Bodies & Cavities
- TD Technical Data

Technical Information

- CV** Check Valves
- SH** Shuttle Valves
- LM** Load/Motor Controls
- FC** Flow Controls
- PC** Pressure Controls
- LE** Logic Elements
- DC** Directional Controls
- MV** Manual Valves
- SV** Solenoid Valves
- PV** Proportional Valves
- CE** Coils & Electronics
- BC** Bodies & Cavities
- TD** Technical Data

General Description

2-Way Spool Valves. For additional information see Technical Tips on pages SV1-SV6.



Features

- High flow capacity with reduced space requirements
- Standard valve bodies and common cavities
- One-piece encapsulated coil with minimal amperage draw
- Manual overrides, seal variations and other options available
- No dynamic seals
- Variety of coil terminations
- Polyurethane "D"-Ring eliminates need for backup rings
- Nylon inserted jam-nut provides secure holding in high vibration applications
- All external parts zinc plated

Specifications

Rated Flow	C - 15 LPM (4 GPM) N - 11 LPM (3 GPM)		
Maximum Inlet Pressure	250 Bar (3600 PSI)		
Leakage at 150 SSU (32cSt)	120 cc/min. (7.5 in ³ /min.) at 250 Bar (3600 PSI)		
Minimum Operating Voltage	85% of rated voltage at 20°C (72°F).		
Response Time		Energized	De-Energized
	C	40 ms	40 ms
	N	40 ms	40 ms
Cartridge Material	All parts steel. All operating parts hardened steel.		
Operating Temp. Range/Seals	-45°C to +93.3°C ("D"-Ring) (-50°F to +200°F)		
	-31.7°C to +121.1°C (Fluorocarbon) (-25°F to +250°F)		
Fluid Compatibility/Viscosity	Mineral-based or synthetic with lubricating properties at viscosities of 45 to 2000 SSU (6 to 420 cSt)		
Filtration	ISO Code 16/13, SAE Class 4 or better		
Approx. Weight	.11 kg (.25 lbs.)		
Cavity	C08-2 (See BC Section for more details)		
Form Tool	Rougher	None	
	Finisher	NFT08-2F	

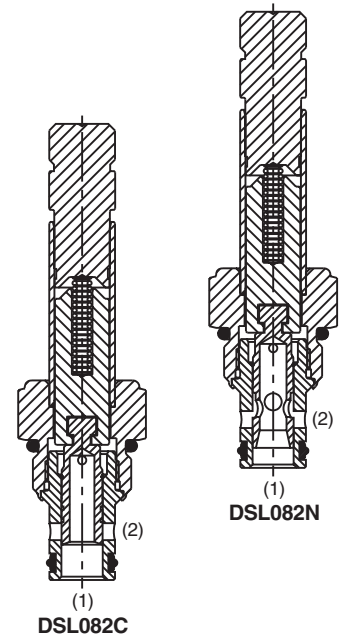
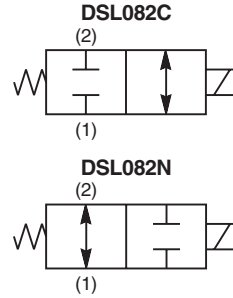

Performance Curves

Pressure Drop vs. Flow (Through cartridge only)

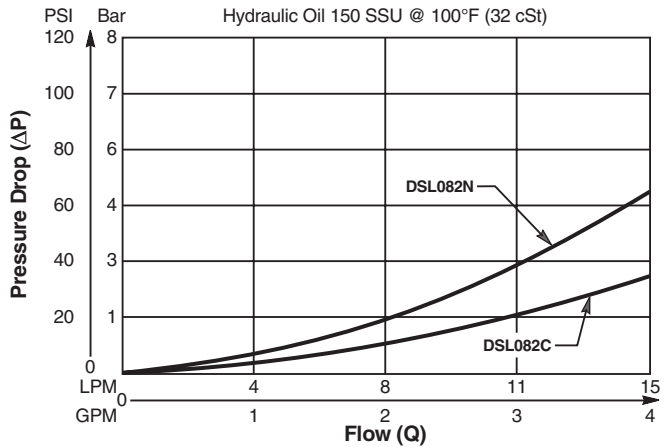

Shift Limit Characteristics (Min. Operating Voltage)

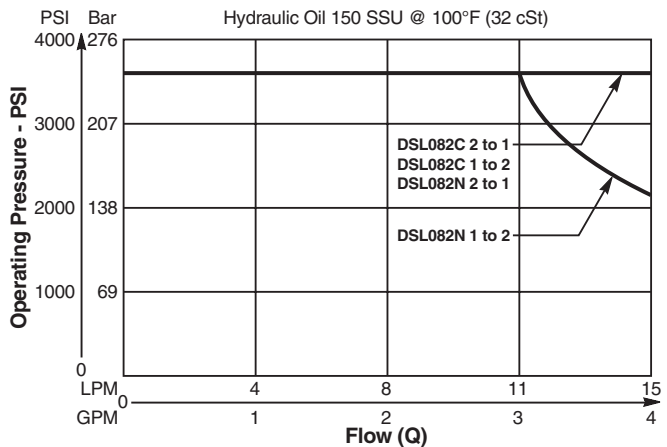

Technical Information

Dimensions Millimeters (Inches)

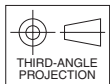
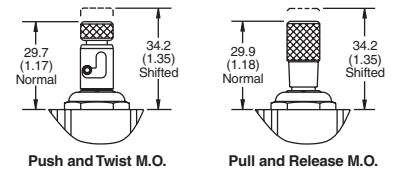
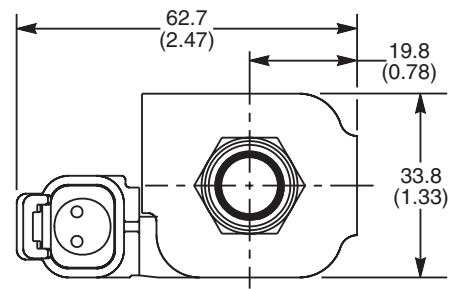
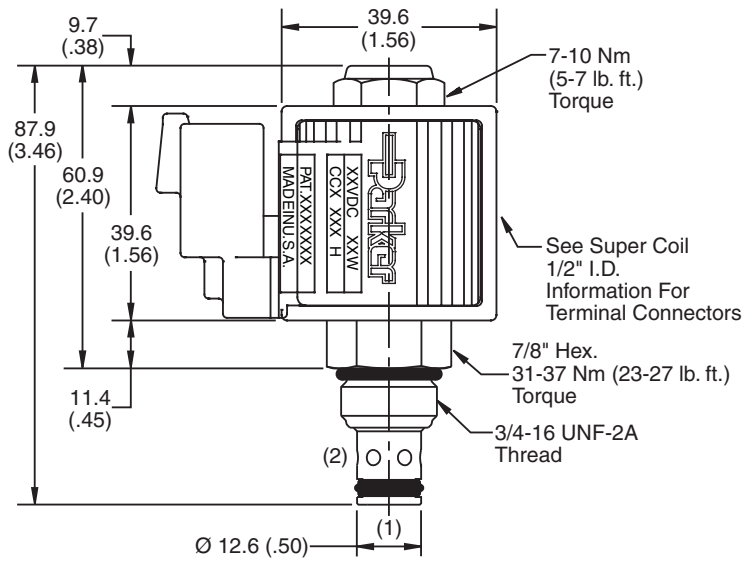

Ordering Information

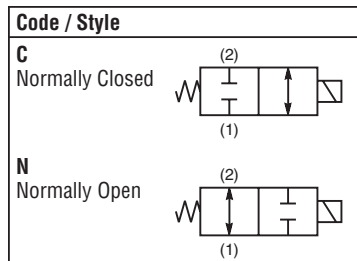
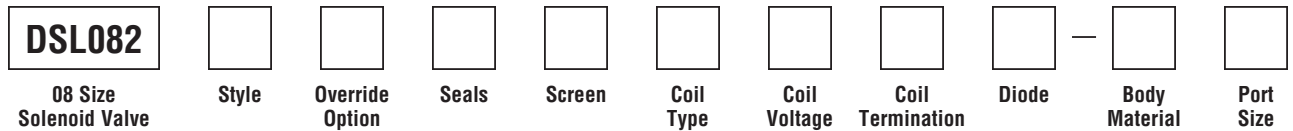

Code	Seals / Kit No.
Omit	"D"-Ring / (SK08-2)
N	Nitrile / (SK08-2N)
V	Fluorocarbon / (SK08-2V)

Code	Coil Voltage
Omit	Without Coil
D012	12 VDC
D024	24 VDC
A120	120/110 VAC, 60/50 Hz
A240	240/220 VAC, 60/50 Hz

Code	Diode
Omit	None
R	Diode

Code	Screen
Omit	None
S	Screen

Code	Body Material
Omit	Steel
A	Aluminum

Code	Override Options
Omit	None
P	Pull & Release
T	Push & Twist

Code	Coil Type
Omit	Without Coil
SP*	Super Coil - 19 Watts

SP*	Coil Termination
Omit	Without Coil
C	Conduit With Leads
D	DIN Plug Face
A	Amp Jr. Timert†
S	Dual Spade†
L	Dual Lead Wire†
LS	Sealed Lead Wire†
H	Molded Deutsch†

Code	Port Size	Body Part No.
Omit	Cartridge Only	
4P	1/4" NPTF	(B08-2-*4P)
6P	3/8" NPTF	(B08-2-*6P)
4T	SAE-4	(B08-2-*4T)
6T	SAE-6	(B08-2-*6T)
6B	3/8" BSPG	(B08-2-*6B)

* Add "A" for aluminum, omit for steel.

*Recommended
†DC Only

- CV**
Check Valves
- SH**
Shuttle Valves
- LM**
Load/Motor Controls
- FC**
Flow Controls
- PC**
Pressure Controls
- LE**
Logic Elements
- DC**
Directional Controls
- MV**
Manual Valves
- SV**
Solenoid Valves
- PV**
Proportional Valves
- CE**
Coils & Electronics
- BC**
Bodies & Cavities
- TD**
Technical Data



Technical Information

- CV** Check Valves
- SH** Shuttle Valves
- LM** Load/Motor Controls
- FC** Flow Controls
- PC** Pressure Controls
- LE** Logic Elements
- DC** Directional Controls
- MV** Manual Valves
- SV** Solenoid Valves
- PV** Proportional Valves
- CE** Coils & Electronics
- BC** Bodies & Cavities
- TD** Technical Data

General Description

2-Way Spool Valves. For additional information see Technical Tips on pages SV1-SV6.



Features

- High flow capacity with reduced space requirements
- Standard valve bodies and common cavities
- One-piece encapsulated coil with minimal amperage draw
- Manual overrides, seal variations and other options available
- No dynamic seals
- Variety of coil terminations
- Polyurethane "D"-Ring eliminates need for backup rings
- Nylon inserted jam-nut provides secure holding in high vibration applications
- All external parts zinc plated

Specifications

Rated Flow	C - 15.0 LPM (4 GPM) N - 8.4 LPM (2.8 GPM)									
Maximum Inlet Pressure	350 Bar (5000 PSI)									
Leakage at 150 SSU (32 cSt)	160 cc/min. (10 in ³ /min.) at 350 Bar (5000 PSI)									
Minimum Operating Voltage	85% of rated voltage at 20°C (72°F).									
Response Time	<table border="1" style="display: inline-table; vertical-align: middle;"> <thead> <tr> <th></th> <th>Energized</th> <th>De-Energized</th> </tr> </thead> <tbody> <tr> <td>C</td> <td>40 ms</td> <td>40 ms</td> </tr> <tr> <td>N</td> <td>40 ms</td> <td>40 ms</td> </tr> </tbody> </table>		Energized	De-Energized	C	40 ms	40 ms	N	40 ms	40 ms
	Energized	De-Energized								
C	40 ms	40 ms								
N	40 ms	40 ms								
Cartridge Material	All parts steel. All operating parts hardened steel.									
Operating Temp. Range/Seals	-45°C to +93.3°C ("D"-Ring) (-50°F to +200°F) -31.7°C to +121.1°C (Fluorocarbon) (-25°F to +250°F)									
Fluid Compatibility/Viscosity	Mineral-based or synthetic with lubricating properties at viscosities of 45 to 2000 SSU (6 to 420 cSt)									
Filtration	ISO Code 16/13, SAE Class 4 or better									
Approx. Weight	.11 kg (.25 lbs.)									
Cavity	C08-2 (See BC Section for more details)									
Form Tool	Rougher None Finisher NFT08-2F									

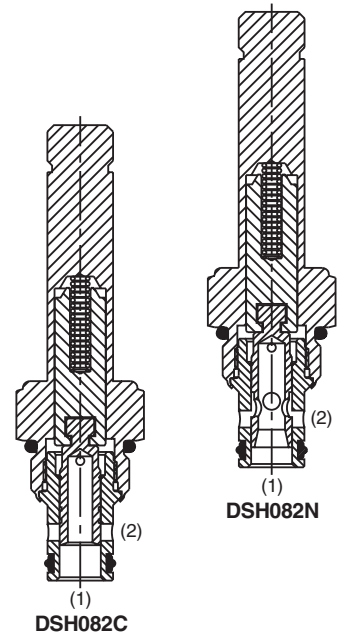
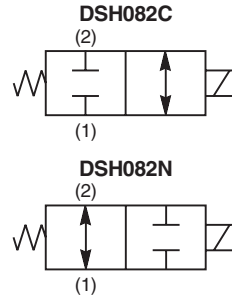

Performance Curves

Pressure Drop vs. Flow (Through cartridge only)

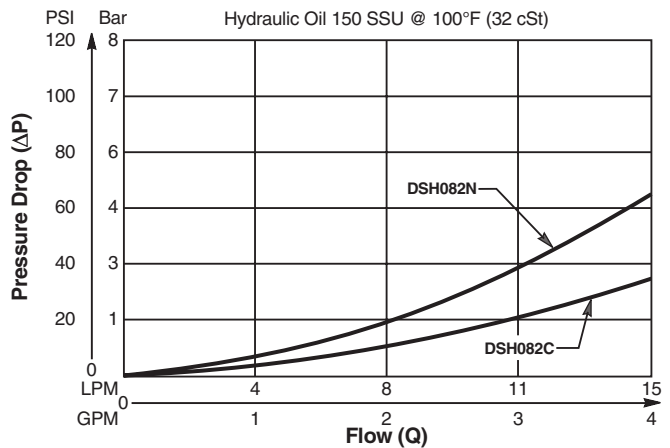

Shift Limit Characteristics (Min. Operating Voltage)

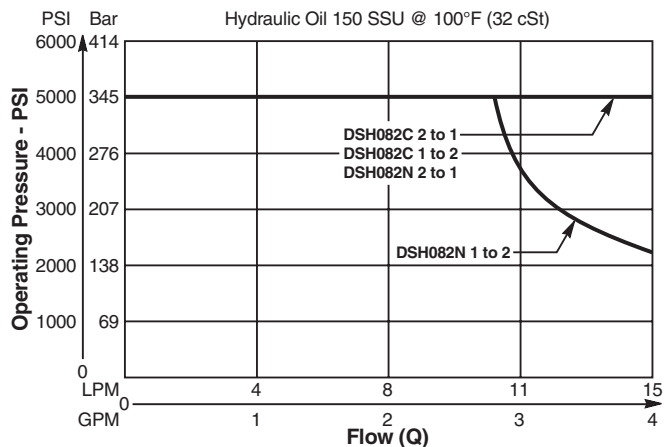

Dimensions Millimeters (Inches)

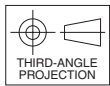
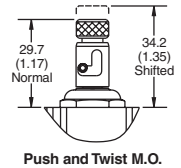
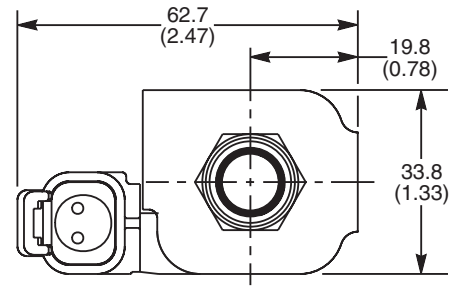
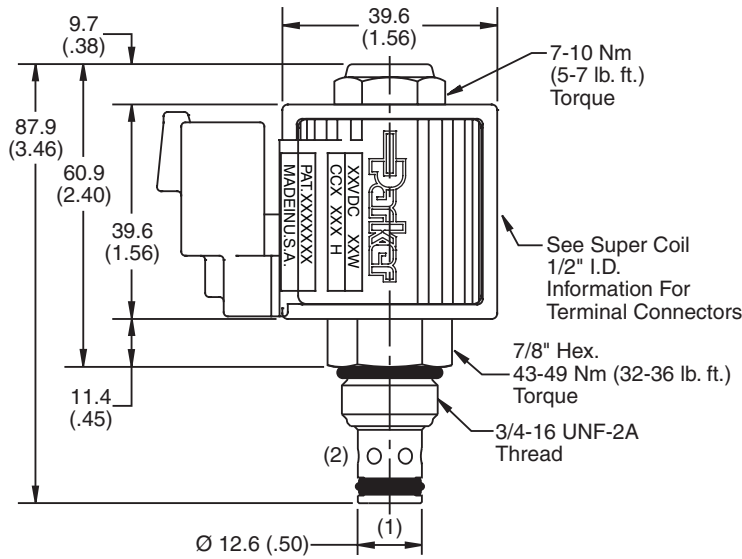

Ordering Information

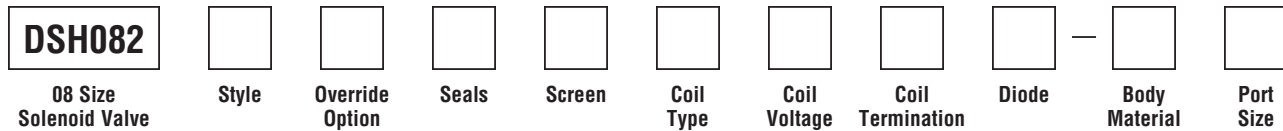

Code / Style	
C Normally Closed	
N Normally Open	

Code	Seals / Kit. No.
Omit	"D"-Ring / (SK08-2)
N	Nitrile / (SK08-2N)
V	Fluorocarbon / (SK08-2V)

Code	Coil Voltage
Omit	Without Coil
D012	12 VDC
D024	24 VDC
A120	120/110 VAC, 60/50 Hz
A240	240/220 VAC, 60/50 Hz

Code	Diode
Omit	None
R	Diode

Code	Screen
Omit	None
S	Screen

Code	Body Material
Omit	Steel
A	Aluminum

Code	Override Options
Omit	None
T	Push & Twist* (N.C. & N.O.)

Code	Coil Type
Omit	Without Coil
SP*	Super Coil - 19 Watts

SP*	Coil Termination
Omit	Without Coil
C	Conduit With Leads
D	DIN Plug Face
A	Amp Jr. Timert†
S	Dual Spade†
L	Dual Lead Wire†
LS	Sealed Lead Wire†
H	Molded Deutsch†

Code	Port Size	Body Part No.
Omit	Cartridge Only	
4P	1/4" NPTF	(B08-2-*4P)
6P	3/8" NPTF	(B08-2-*6P)
4T	SAE-4	(B08-2-*4T)
6T	SAE-6	(B08-2-*6T)
6B	3/8" BSPG	(B08-2-*6B)

*Requires Super Coil

*Recommended

*Recommended
†DC Only

* Add "A" for aluminum, omit for steel.

Technical Information

- CV** Check Valves
- SH** Shuttle Valves
- LM** Load/Motor Controls
- FC** Flow Controls
- PC** Pressure Controls
- LE** Logic Elements
- DC** Directional Controls
- MV** Manual Valves
- SV** Solenoid Valves
- PV** Proportional Valves
- CE** Coils & Electronics
- BC** Bodies & Cavities
- TD** Technical Data

General Description

2-Way Spool Valves. For additional information see Technical Tips on pages SV1-SV6.



Features

- High flow capacity with reduced space requirements
- Standard valve bodies and common cavities
- One-piece encapsulated coil with minimal amperage draw
- Manual overrides, seal variations and other options available
- No dynamic seals
- Variety of coil terminations
- Polyurethane "D"-Ring
- All external parts zinc plated

Specifications

Rated Flow	C - 30 LPM (8.0 GPM) N - 21 LPM (5.5 GPM)	
Maximum Inlet Pressure	250 Bar (3600 PSI)	
Leakage at 150 SSU (32 cSt)	120 cc/min. (7.5 in ³ /min.)	
Minimum Operating Voltage	85% of rated voltage at 20°C (72°F).	
Response Time	C	De-Energized
	N	Energized
		30 ms
		20 ms
		50 ms
		25 ms
Cartridge Material	All parts steel. All operating parts hardened steel.	
Operating Temp. Range/Seals	-45°C to +93.3°C ("D"-Ring) (-50°F to +200°F) -31.7°C to +121.1°C (Fluorocarbon) (-25°F to +250°F)	
Fluid Compatibility/Viscosity	Mineral-based or synthetic with lubricating properties at viscosities of 45 to 2000 SSU (6 to 420 cSt)	
Filtration	ISO Code 16/13, SAE Class 4 or better	
Approx. Weight	.18 kg (.41 lbs.)	
Cavity	C10-2 (See BC Section for more details)	
Form Tool	Rougher Finisher	None NFT10-2F

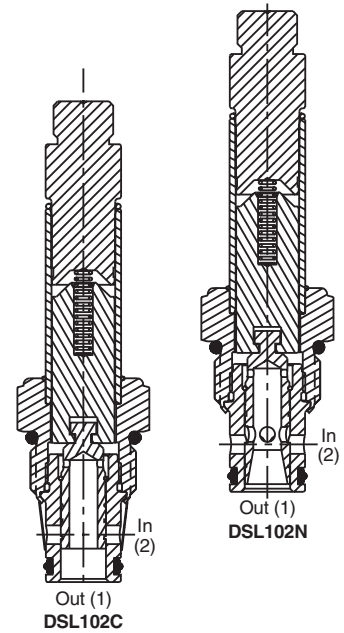
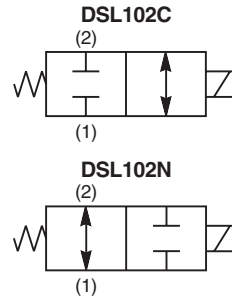

Performance Curves

Pressure Drop vs. Flow (Through cartridge only)

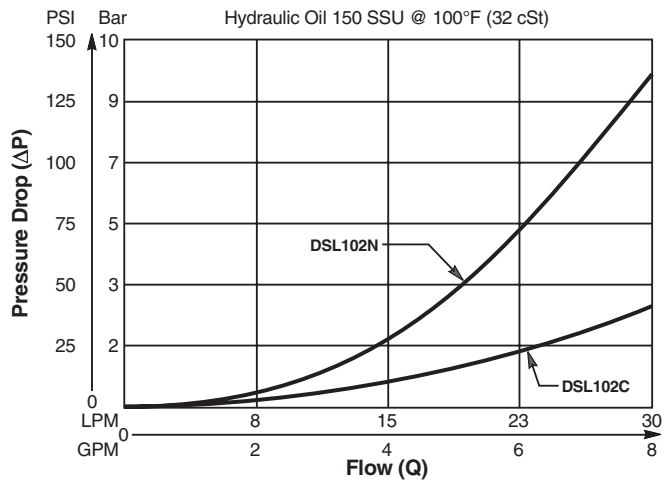

Shift Limit Characteristics (Min. Operating Voltage)

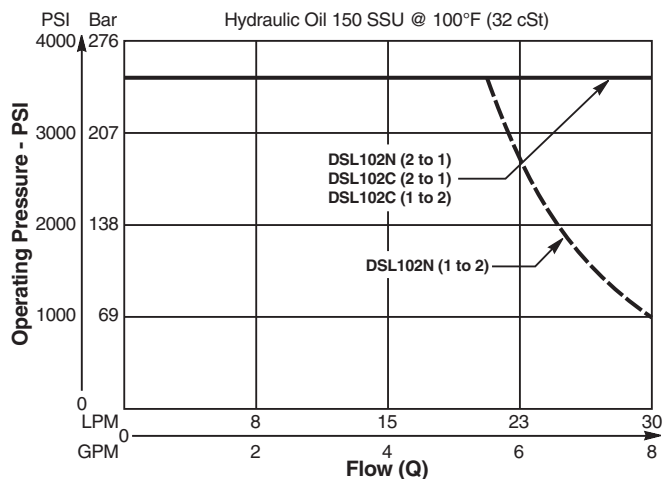

Technical Information

Dimensions Millimeters (Inches)

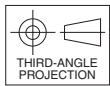
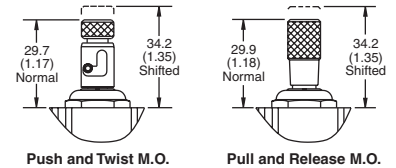
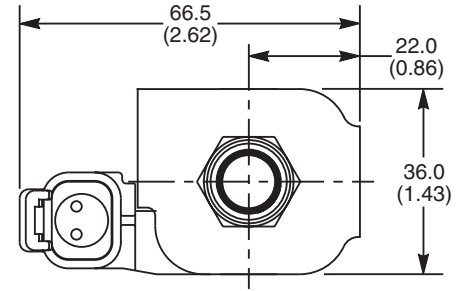
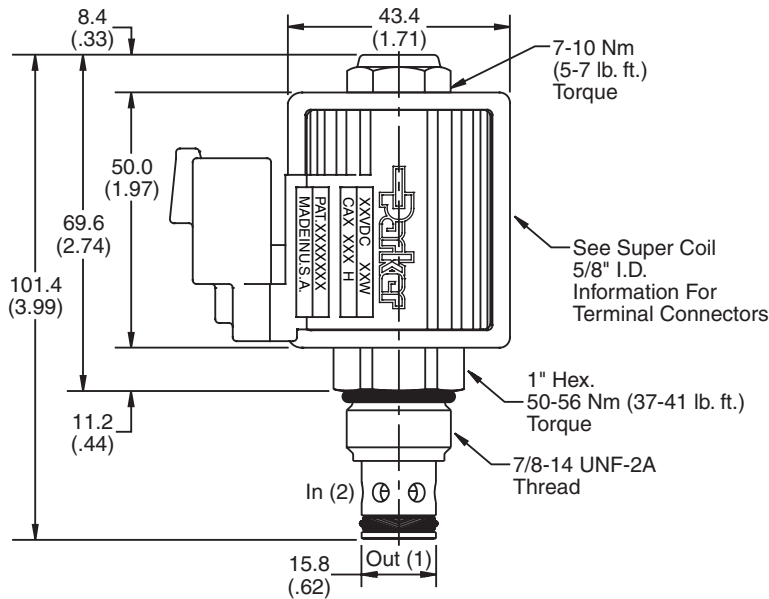

Ordering Information

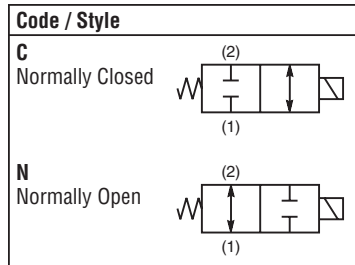
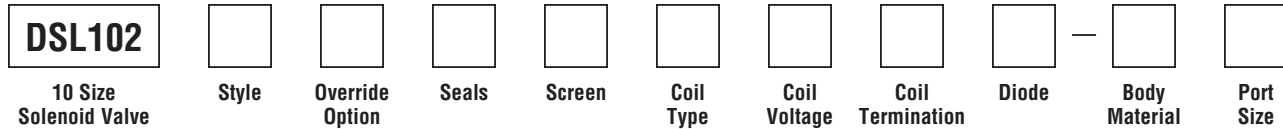

Code	Override Options
Omit	None
P	Pull & Release
T	Push & Twist

Code	Seals / Kit No.
Omit	"D"-Ring / (SK10-2)
N	Nitrile / (SK10-2N)
V	Fluorocarbon / (SK10-2V)

Code	Screen
Omit	None
S	Screen

Code	Coil Type
Omit	Without Coil
SP*	Super Coil - 28 Watts

*Recommended

Code	Coil Voltage
Omit	Without Coil
D012	12 VDC
D024	24 VDC
A120	120/110 VAC, 60/50 Hz
A240	240/220 VAC, 60/50 Hz

SP* Coil	Coil Termination
Omit	Without Coil
C	Conduit With Leads
D	DIN Plug Face
A	Amp Jr. Timert
S	Dual Spade†
L	Dual Lead Wire†
LS	Sealed Lead Wire†
H	Molded Deutsch†

*Recommended
†DC Only

Code	Diode
Omit	None
R	Diode

Code	Body Material
Omit	Steel
A	Aluminum

Code	Port Size	Body Part No.
Omit	Cartridge Only	
4P	1/4" NPTF	(B10-2-*4P)
6P	3/8" NPTF	(B10-2-*6P)
8P	1/2" NPTF	(B10-2-*8P)
6T	SAE-6	(B10-2-*6T)
8T	SAE-8	(B10-2-*8T)
T8T	SAE-8	(B10-2-T8T)†
6B	3/8" BSPG	(B10-2-6B)†

* Add "A" for aluminum. omit for steel.
† Steel body only.

Technical Information

- CV** Check Valves
- SH** Shuttle Valves
- LM** Load/Motor Controls
- FC** Flow Controls
- PC** Pressure Controls
- LE** Logic Elements
- DC** Directional Controls
- MV** Manual Valves
- SV** Solenoid Valves
- PV** Proportional Valves
- CE** Coils & Electronics
- BC** Bodies & Cavities
- TD** Technical Data

General Description

2-Way Spool Valves. For additional information see Technical Tips on pages SV1-SV6.



Features

- High flow capacity with reduced space requirements
- Standard valve bodies and common cavities
- One-piece encapsulated coil with minimal amperage draw
- Manual overrides, seal variations and other options available
- No dynamic seals
- Variety of coil terminations
- Polyurethane "D"-Ring eliminates need for backup rings
- Nylon inserted jam-nut provides secure holding in high vibration applications
- All external parts zinc plated

Specifications

Rated Flow	C - 30 LPM (8.0 GPM) N - 19 LPM (5.0 GPM)	
Maximum Inlet Pressure	350 Bar (5000 PSI)	
Leakage at 150 SSU (32 cSt)	160 cc/min. (10 in ³ /min.)	
Minimum Operating Voltage	85% of rated voltage at 20°C (72°F).	
Response Time	Energized	De-Energized
	C 30 ms	20 ms
	N 50 ms	25 ms
Cartridge Material	All parts steel. All operating parts hardened steel.	
Operating Temp. Range/Seals	-45°C to +93.3°C ("D"-Ring) (-50°F to +200°F) -31.7°C to +121.1°C (Fluorocarbon) (-25°F to +250°F)	
Fluid Compatibility/Viscosity	Mineral-based or synthetic with lubricating properties at viscosities of 45 to 2000 SSU (6 to 420 cSt)	
Filtration	ISO Code 16/13, SAE Class 4 or better	
Approx. Weight	.18 kg (.40 lbs.)	
Cavity	C10-2 (See BC Section for more details)	
Form Tool	Rougher	None
	Finisher	NFT10-2F

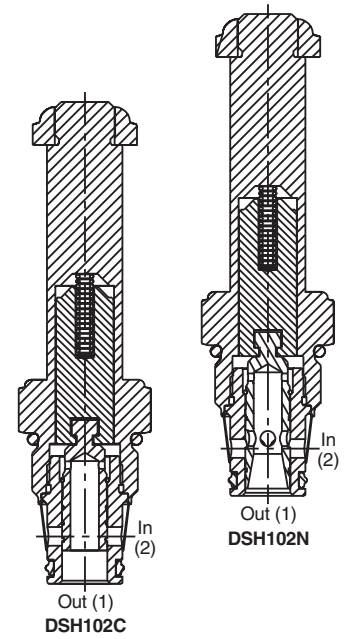
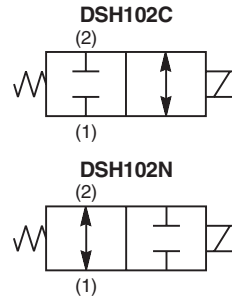

Performance Curves

Pressure Drop vs. Flow (Through cartridge only)

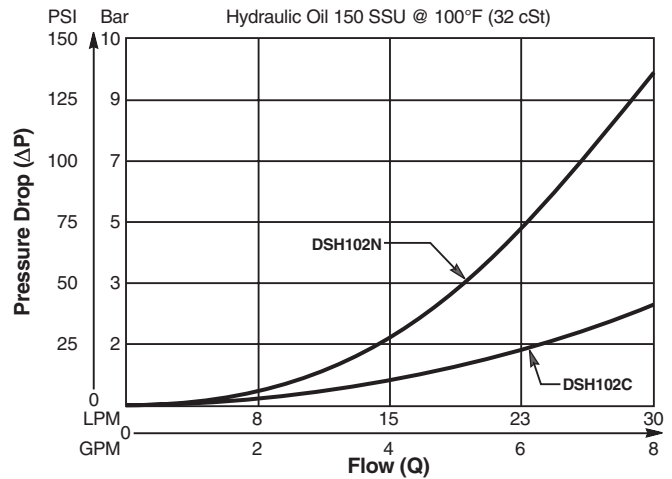

Shift Limit Characteristics (Min. Operating Voltage)

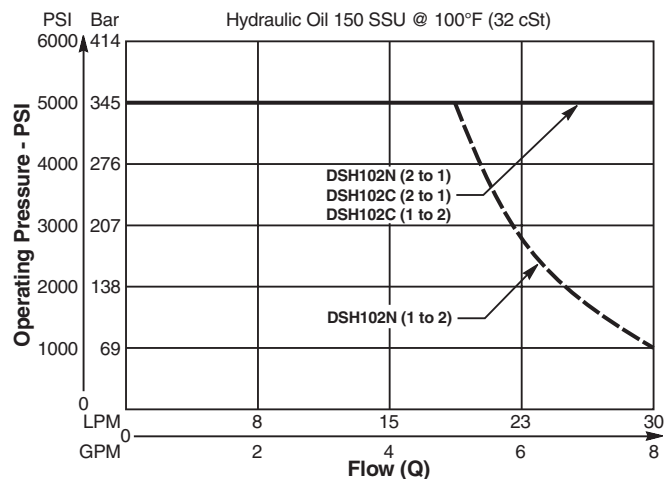

Dimensions Millimeters (Inches)

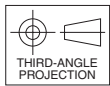
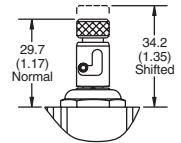
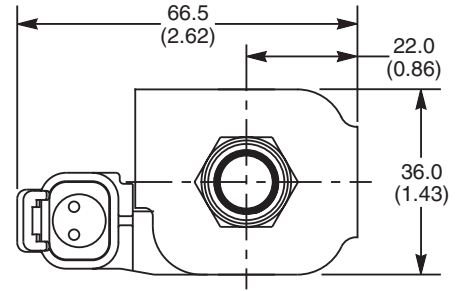
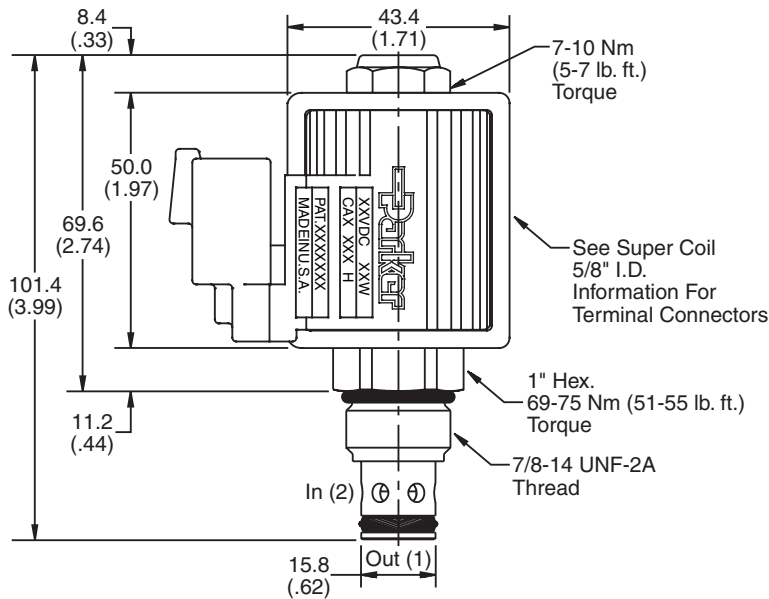

Ordering Information

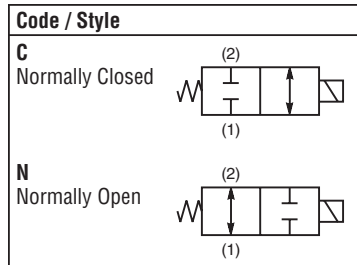
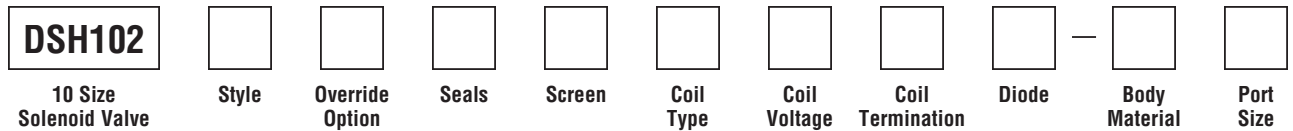

Code	Override Options
Omit	None
T	Push & Twist (N.C. & N.O.)

Code	Seals / Kit No.
Omit	"D"-Ring / (SK10-2)
N	Nitrile / (SK10-2N)
V	Fluorocarbon / (SK10-2V)

Code	Screen
Omit	None
S	Screen

Code	Coil Type
Omit	Without Coil
SP*	Super Coil - 28 Watts

*Recommended

Code	Coil Voltage
Omit	Without Coil
D012	12 VDC
D024	24 VDC
A120	120/110 VAC, 60/50 Hz
A240	240/220 VAC, 60/50 Hz

SP* Coil	Coil Termination
Omit	Without Coil
C	Conduit With Leads
D	DIN Plug Face
A	Amp Jr. Timert
S	Dual Spade†
L	Dual Lead Wire†
LS	Sealed Lead Wire†
H	Molded Deutsch†

*Recommended
†DC Only

Code	Diode
Omit	None
R	Diode

Code	Body Material
Omit	Steel
A	Aluminum

Code	Port Size	Body Part No.
Omit	Cartridge Only	
4P	1/4" NPTF	(B10-2-*4P)
6P	3/8" NPTF	(B10-2-*6P)
8P	1/2" NPTF	(B10-2-*8P)
6T	SAE-6	(B10-2-*6T)
8T	SAE-8	(B10-2-*8T)
T8T	SAE-8	(B10-2-T8T)†
6B	3/8" BSPG	(B10-2-6B)†

* Add "A" for aluminum. omit for steel.
† Steel body only.

Technical Information

- CV** Check Valves
- SH** Shuttle Valves
- LM** Load/Motor Controls
- FC** Flow Controls
- PC** Pressure Controls
- LE** Logic Elements
- DC** Directional Controls
- MV** Manual Valves
- SV** Solenoid Valves
- PV** Proportional Valves
- CE** Coils & Electronics
- BC** Bodies & Cavities
- TD** Technical Data

General Description

2-Way Spool Valves. For additional information see Technical Tips on pages SV1-SV6.

Features

- Low hysteresis
- One-piece encapsulated coil with minimal amperage draw
- Variety of coil terminations and voltages
- Manual override standard (push and release)
- All external parts zinc plated

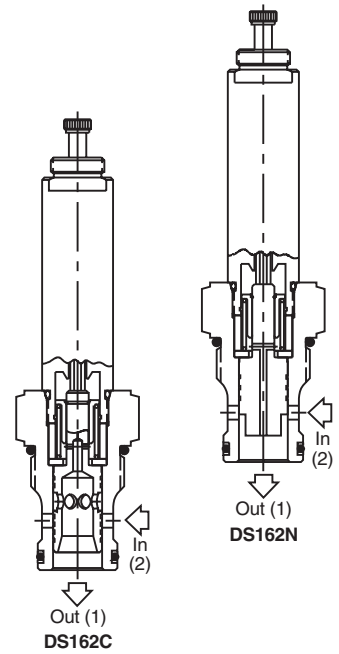
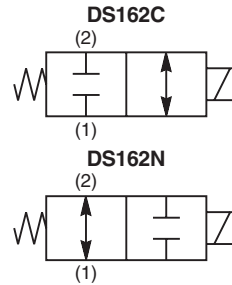
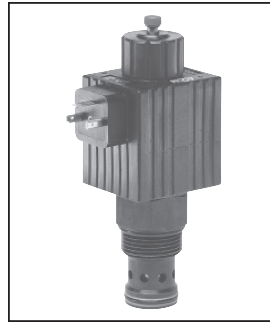

Specifications

Rated Flow	75 LPM (20 GPM)
Maximum Inlet Pressure	210 Bar (3000 PSI)
Leakage at 150 SSU (32 cSt)	240 cc/min. (15 in ³ /min.)
Minimum Operating Voltage	85% of rated voltage at 20°C (72°F).
Response Time	C - 90 ms N - 100 ms
Cartridge Material	All parts steel. All operating parts hardened steel.
Operating Temp. Range/Seals	-40°C to +93.3°C (Nitrile) (-40°F to +200°F) -31.7°C to +121.1°C (Fluorocarbon) (-25°F to +250°F)
Fluid Compatibility/Viscosity	Mineral-based or synthetic with lubricating properties at viscosities of 45 to 2000 SSU (6 to 420 cSt)
Filtration	ISO Code 16/13, SAE Class 4 or better
Approx. Weight	.59 kg (1.3 lbs.)
Cavity	C16-2 (See BC Section for more details)
Form Tool	Rougher None Finisher NFT16-2F

Performance Curves

Pressure Drop vs. Flow (Through cartridge only)

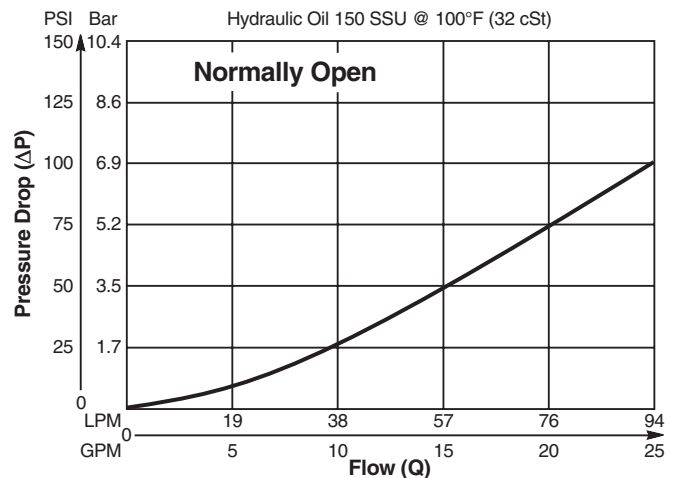
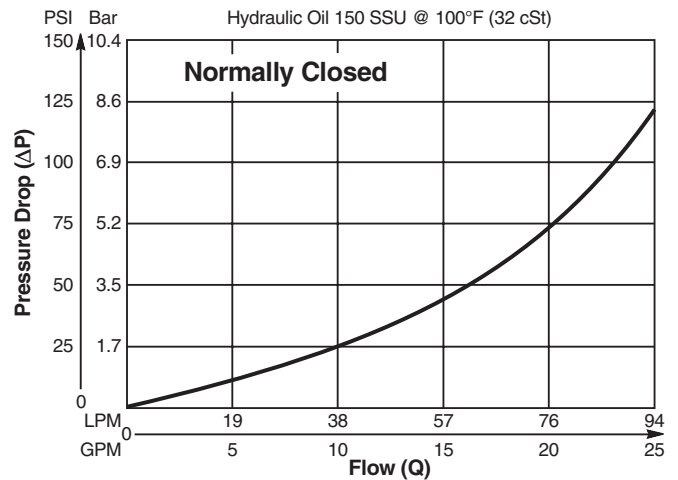

Technical Information

Dimensions Millimeters (Inches)

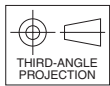
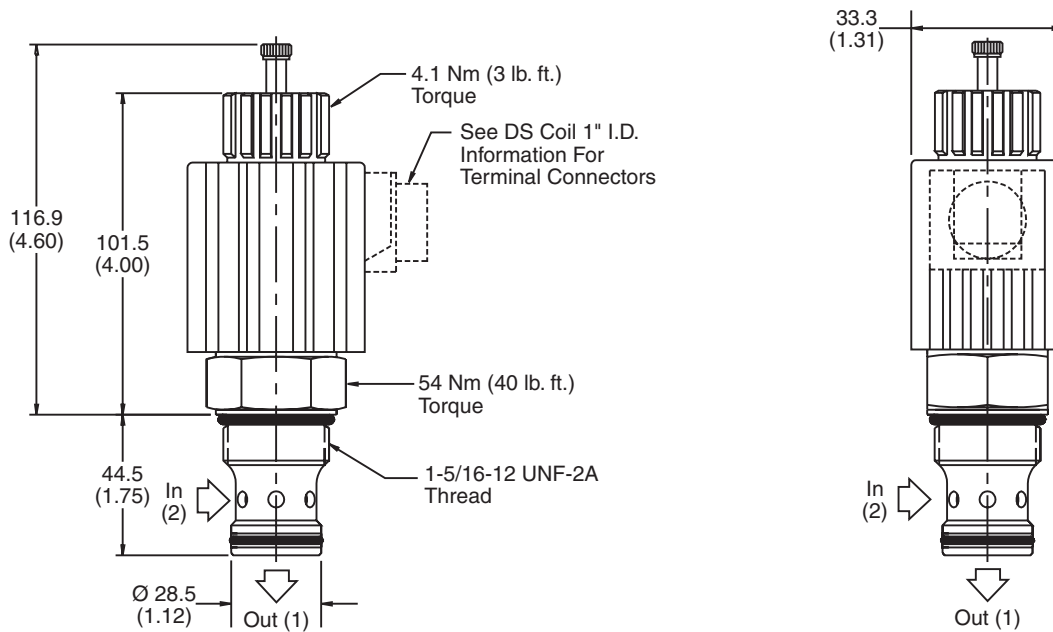

Ordering Information

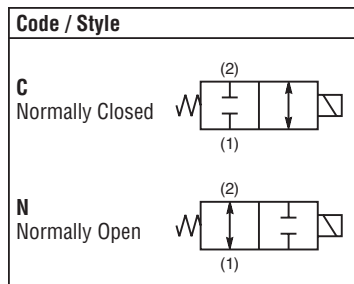
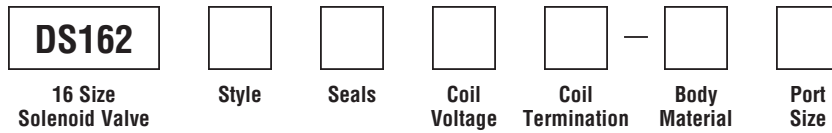

Code	Seals / Kit No.
Omit	Nitrile / (SK16-2)
V	Fluorocarbon / (SK16-2V)

Code	Coil Voltage
Omit	Without Coil
D012	12 VDC
D024	24 VDC
A120	120/110 VAC, 60/50 Hz

Code	Coil Termination
Omit	Without Coil
C	Conduit (AC Only)
D	DIN Plug Face
P	Dual Spade (DC Only)
S	Dual Screw (DC Only)
W	Dual Lead (DC Only)

See DS coil 1" I.D.

Code	Body Material
Omit	Steel
A	Aluminum

Code	Port Size	Body Part No.
Omit	Cartridge Only	
12T	SAE-12	(B16-2-*12T)
16T	SAE-16	(B16-2-*16T)
12B	3/4" BSPG	(B16-2-*12B)
16B	1" BSPG	(B16-2-16B)†

* Add "A" for aluminum, omit for steel.
† Steel body only.



- CV Check Valves
- SH Shuttle Valves
- LM Load/Motor Controls
- FC Flow Controls
- PC Pressure Controls
- LE Logic Elements
- DC Directional Controls
- MV Manual Valves
- SV Solenoid Valves
- PV Proportional Valves
- CE Coils & Electronics
- BC Bodies & Cavities
- TD Technical Data

Technical Information

- CV** Check Valves
- SH** Shuttle Valves
- LM** Load/Motor Controls
- FC** Flow Controls
- PC** Pressure Controls
- LE** Logic Elements
- DC** Directional Controls
- MV** Manual Valves
- SV** Solenoid Valves
- PV** Proportional Valves
- CE** Coils & Electronics
- BC** Bodies & Cavities
- TD** Technical Data

General Description

3-Way Spool Valves. For additional information see Technical Tips on pages SV1-SV6.



Features

- High flow capacity with reduced space requirements
- Standard valve bodies and common cavities
- One piece encapsulated coils with minimal amperage draw
- Manual overrides, seal variations and other options available
- No dynamic seals
- Variety of coil terminations
- Polyurethane "D"-Ring eliminates need for backup rings
- Nylon inserted jam-nut provides secure holding in high vibration applications
- All external parts zinc plated

Specifications

Rated Flow	DSL083A	N.O. 13.2 LPM (3.5 GPM)
		N.C. 8.4 LPM (2.25 GPM)
	DSL083B	Selector 8.4 LPM (2.25 GPM)
		N.C. 15.0 LPM (4.0 GPM)
	DSL083C	Selector 15.0 LPM (4.0 GPM)
		N.O. 15.0 LPM (4.0 GPM)
	DSL083N	N.O. 12.3 LPM (3.25 GPM)
		Selector 15.0 LPM (4.0 GPM)
Maximum Inlet Pressure	250 Bar (3600 PSI)	
Leakage at 150 SSU (32 cSt)	120 cc/min. (7.5 in ³ /min.) at 250 Bar (3600 PSI) DSL083B - 180 cc/min. (11 in ³ /min.) DSL083N - 180 cc/min. (11 in ³ /min.)	
Minimum Operating Voltage	85% of rated voltage at 20°C (72°F).	
Response Time	50 ms	
Cartridge Material	All parts steel. All operating parts hardened steel.	
Operating Temp. Range/Seals	-45°C to +93.3°C ("D"-Ring) (-50°F to +200°F) -31.7°C to +121.1°C (Fluorocarbon) (-25°F to +250°F)	
Fluid Compatibility/Viscosity	Mineral-based or synthetic with lubricating properties at viscosities of 45 to 2000 SSU (6 to 420 cSt)	
Filtration	ISO Code 16/13, SAE Class 4 or better	
Approx. Weight	.13 kg (.28 lbs.)	
Cavity	C08-3 (See BC Section for more details)	
Form Tool	Rougher	NFT08-3R
	Finisher	NFT08-3F

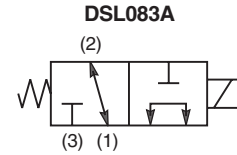

Construction/Symbols

DSL083A

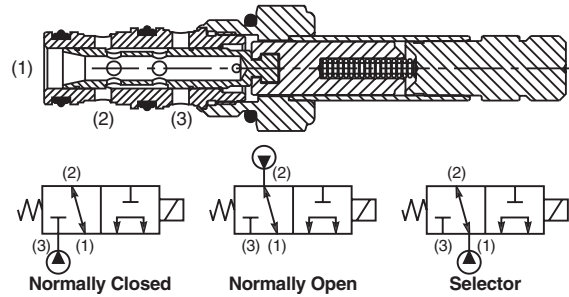

DSL083B

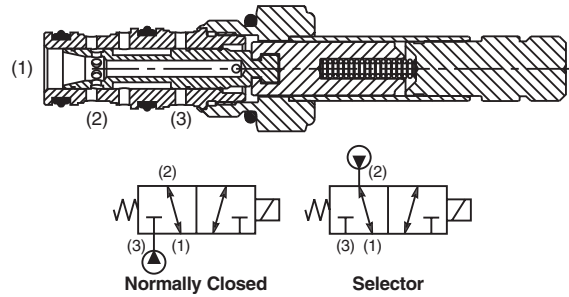

DSL083C

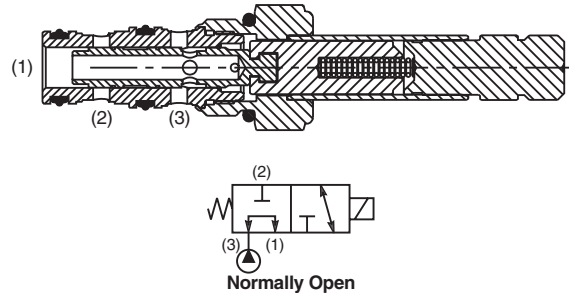

DSL083N

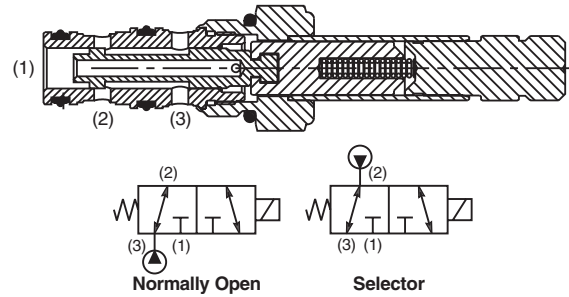

Dimensions Millimeters (Inches)

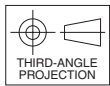
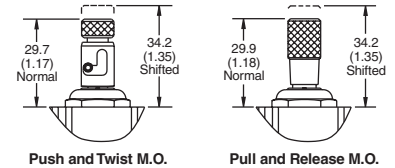
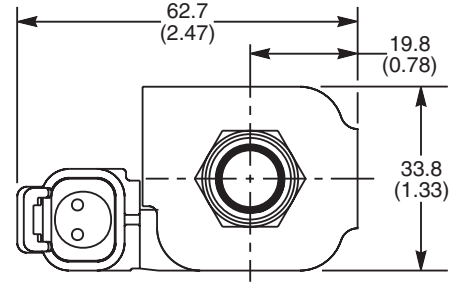
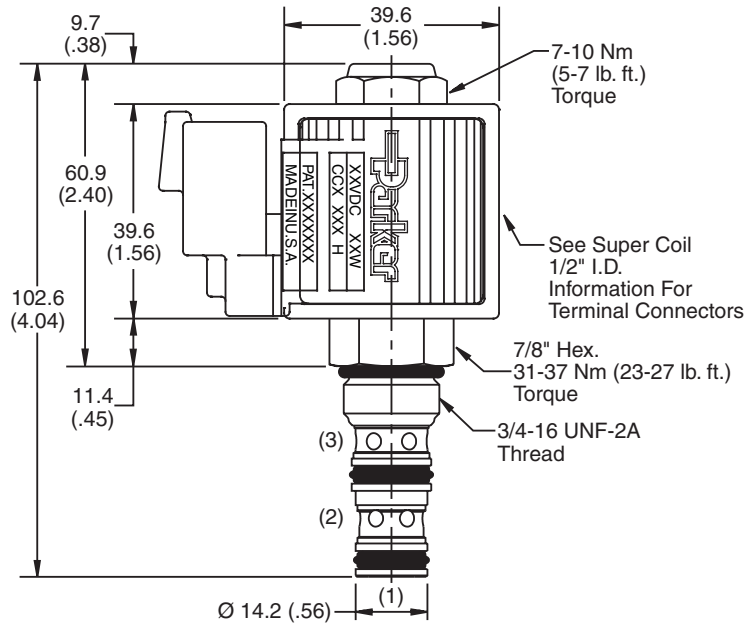

Ordering Information

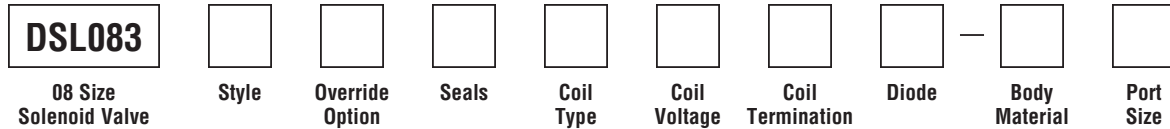

Code	Style
A	
B	
C	
N	

Code	Override Options
Omit	None
P	Pull & Release
T	Push & Twist

Code	Seals / Kit No.
Omit	"D"-Ring / (SK08-3)
N	Nitrile / (SK08-3N)
V	Fluorocarbon / (SK08-3V)

Code	Coil Type
Omit	Without Coil
SP*	Super Coil - 19 Watts

*Recommended

Code	Coil Voltage
Omit	Without Coil
D012	12 VDC
D024	24 VDC
A120	120/110 VAC, 60/50 Hz
A240	240/220 VAC, 60/50 Hz

SP*	Coil Termination
Omit	Without Coil
C	Conduit With Leads
D	DIN Plug Face
A	Amp Jr. Timert†
S	Dual Spade†
L	Dual Lead Wire†
LS	Sealed Lead Wire†
H	Molded Deutsch†

*Recommended
 †DC Only

Code	Diode
Omit	None
R	Diode

Code	Body Material
Omit	Steel
A	Aluminum

Code	Port Size	Body Part No.
Omit	Cartridge Only	
4P	1/4" NPTF	(B08-3-*4P)
4T	SAE-4	(B08-3-*4T)
6T	SAE-6	(B08-3-*6T)
6B	3/8" BSPG	(B08-3-*6B)

* Add "A" for aluminum, omit for steel.

- CV** Check Valves
- SH** Shuttle Valves
- LM** Load/Motor Controls
- FC** Flow Controls
- PC** Pressure Controls
- LE** Logic Elements
- DC** Directional Controls
- MV** Manual Valves
- SV** Solenoid Valves
- PV** Proportional Valves
- CE** Coils & Electronics
- BC** Bodies & Cavities
- TD** Technical Data

Pressure Drop vs. Flow (Through cartridge only)

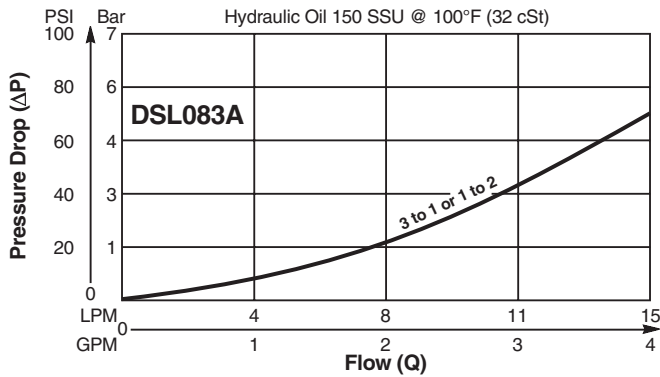

Shift Limit Characteristics (Min. Operating Voltage)

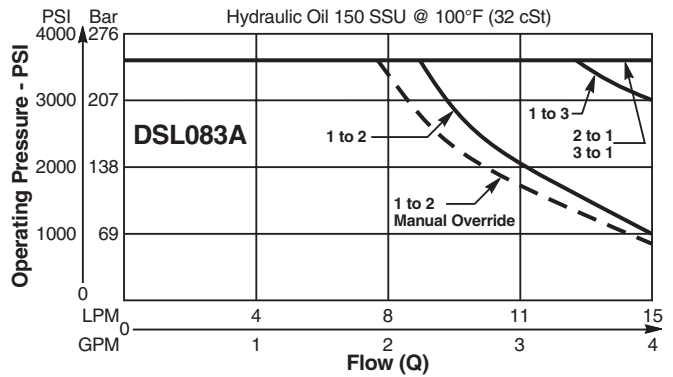

Pressure Drop vs. Flow (Through cartridge only)

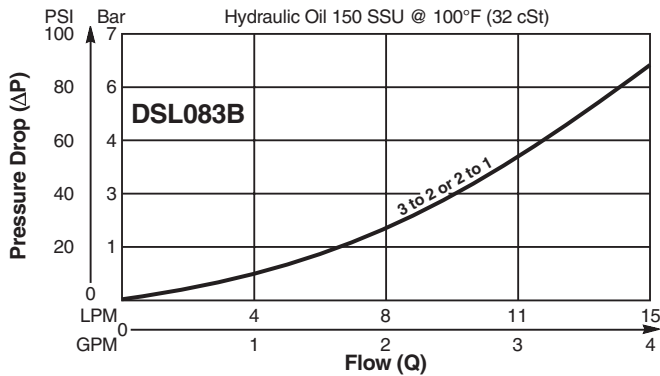

Shift Limit Characteristics (Min. Operating Voltage)

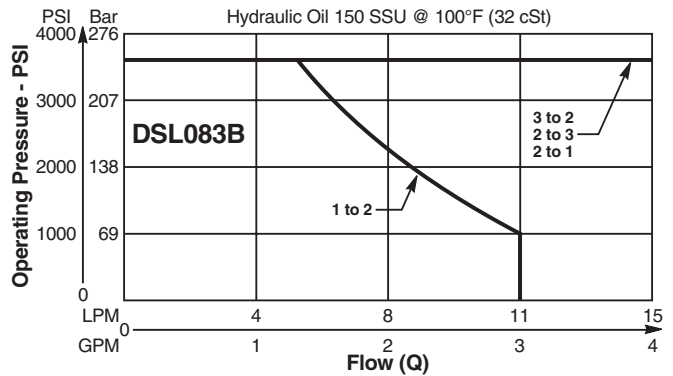

Pressure Drop vs. Flow (Through cartridge only)

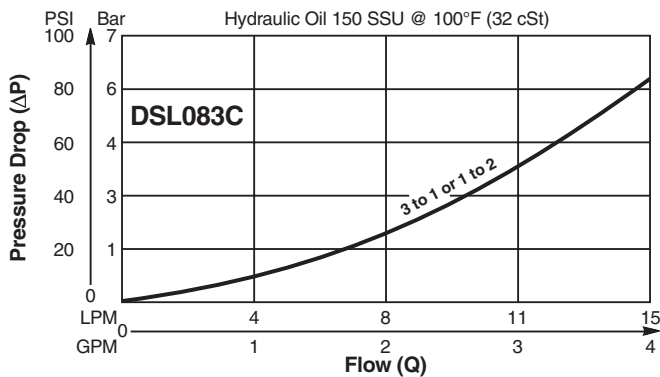

Shift Limit Characteristics (Min. Operating Voltage)

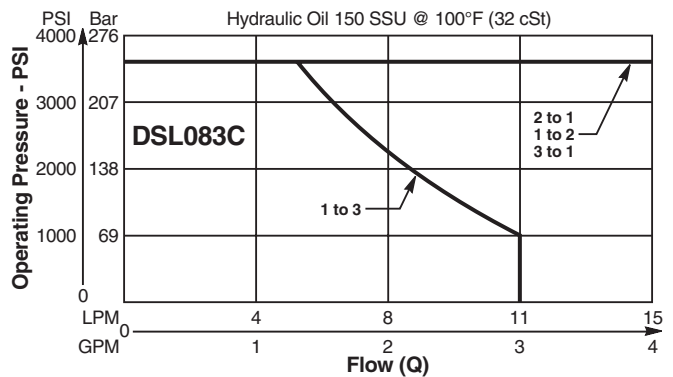

Pressure Drop vs. Flow (Through cartridge only)

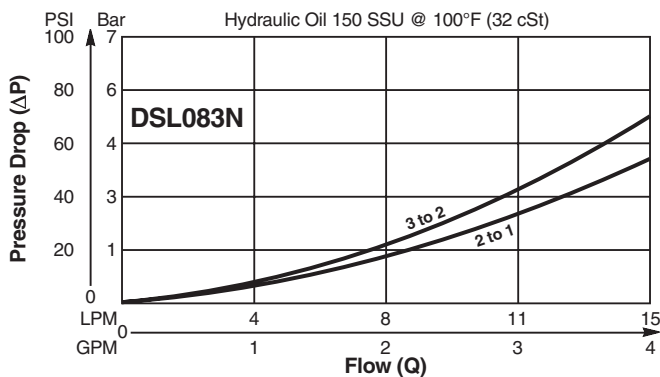

Shift Limit Characteristics (Min. Operating Voltage)

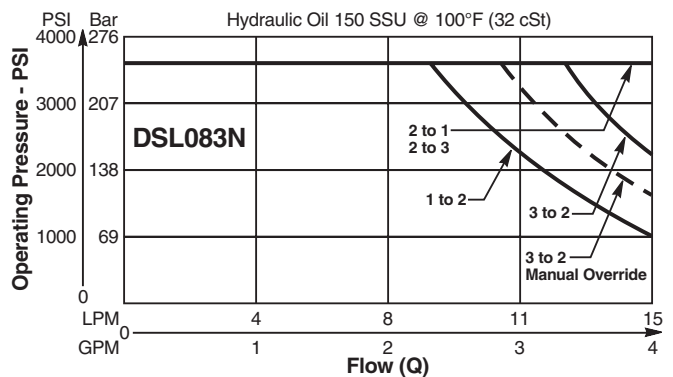

Technical Information

General Description

3-Way Spool Valves. For additional information see Technical Tips on pages SV1-SV6.



Features

- High flow capacity with reduced space requirements
- Standard valve bodies and common cavities
- One piece encapsulated coils with minimal amperage draw
- Manual overrides, seal variations and other options available
- No dynamic seals
- Variety of coil terminations
- Polyurethane "D"-Ring eliminates need for backup rings
- Nylon inserted jam-nut provides secure holding in high vibration applications
- All external parts zinc plated

Specifications

Rated Flow	DSH083A	N.O.	11.3 LPM (3.0 GPM)
		N.C.	7.5 LPM (2.0 GPM)
		Selector	7.5 LPM (2.0 GPM)
	DSH083B	N.C.	15.0 LPM (4.0 GPM)
		Selector	15.0 LPM (4.0 GPM)
	DSH083C	N.O.	15.0 LPM (4.0 GPM)
Maximum Inlet Pressure	350 Bar (5000 PSI)		
	Leakage at 150 SSU (32 cSt)	160 cc/min. (10 in ³ /min.) at 350 Bar (5000 PSI)	
		DSH083B - 250 cc/min. (15 in ³ /min.)	
DSH083N - 250 cc/min. (15 in ³ /min.)			
Minimum Operating Voltage	85% of rated voltage at 20°C (72°F).		
Response Time	50 ms		
Cartridge Material	All parts steel. All operating parts hardened steel.		
Operating Temp. Range/Seals	-45°C to +93.3°C ("D"-Ring) (-50°F to +200°F) -31.7°C to +121.1°C (Fluorocarbon) (-25°F to +250°F)		
Fluid Compatibility/Viscosity	Mineral-based or synthetic with lubricating properties at viscosities of 45 to 2000 SSU (6 to 420 cSt)		
Filtration	ISO Code 16/13, SAE Class 4 or better		
Approx. Weight	.13 kg (.28 lbs.)		
Cavity	C08-3 (See BC Section for more details)		
Form Tool	Rougher	NFT08-3R	
	Finisher	NFT08-3F	

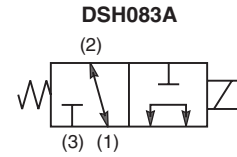
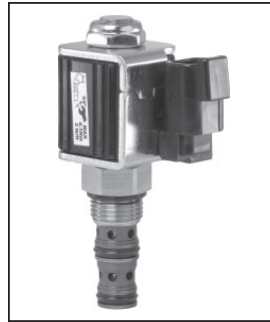

Construction/Symbols

DSH083A

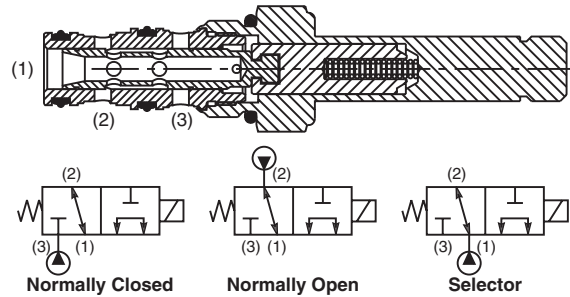

DSH083B

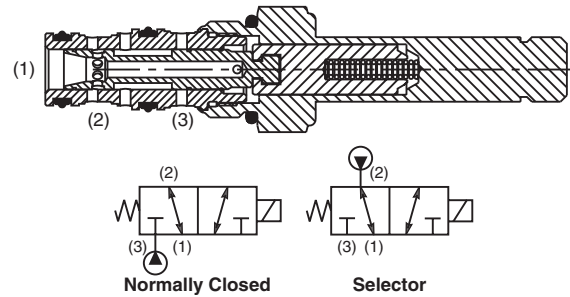

DSH083C

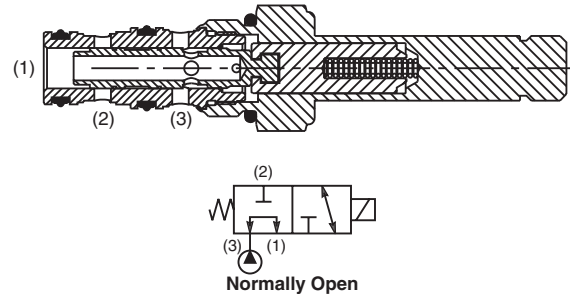

DSH083N

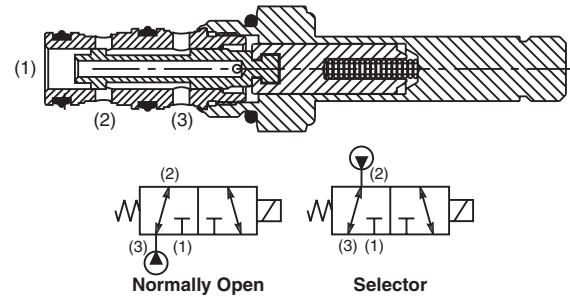

- CV** Check Valves
- SH** Shuttle Valves
- LM** Load/Motor Controls
- FC** Flow Controls
- PC** Pressure Controls
- LE** Logic Elements
- DC** Directional Controls
- MV** Manual Valves
- SV** Solenoid Valves
- PV** Proportional Valves
- CE** Coils & Electronics
- BC** Bodies & Cavities
- TD** Technical Data

Technical Information

Dimensions Millimeters (Inches)

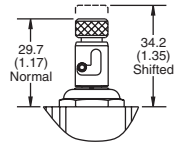
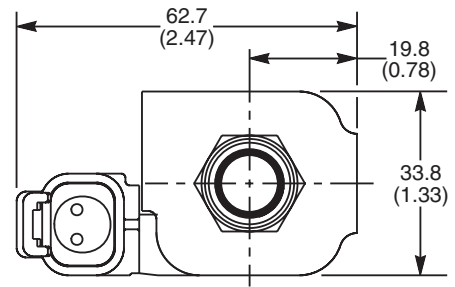
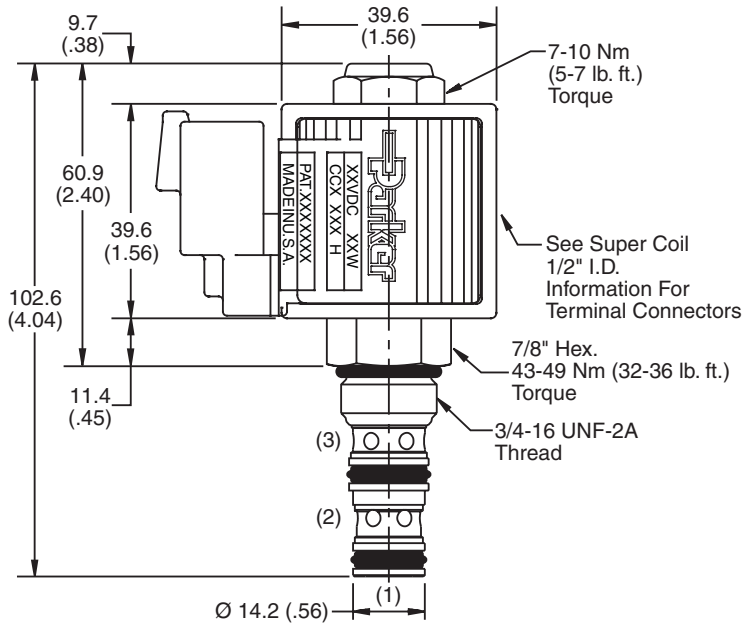

Push and Twist M.O.

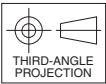

Ordering Information

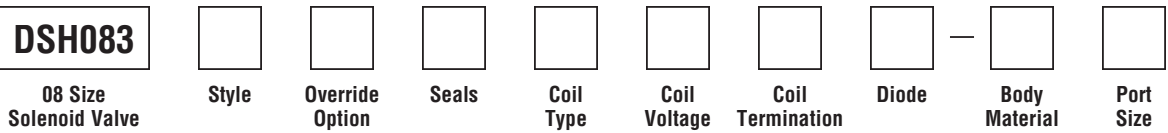

Code	Style
A	
B	
C	
N	

Code	Override Options
Omit	None
T	Push & Twist* (N.C. & N.O.)

Code	Seals / Kit No.
Omit	"D"-Ring / (SK08-3)
N	Nitrile / (SK08-3N)
V	Fluorocarbon / (SK08-3V)

Code	Coil Type
Omit	Without Coil
SP*	Super Coil - 19 Watts

Code	Coil Voltage
Omit	Without Coil
D012	12 VDC
D024	24 VDC
A120	120/110 VAC, 60/50 Hz
A240	240/220 VAC, 60/50 Hz

SP*	Coil Termination
Omit	Without Coil
C	Conduit With Leads
D	DIN Plug Face
A	Amp Jr. Timert†
S	Dual Spade†
L	Dual Lead Wire†
LS	Sealed Lead Wire†
H	Molded Deutsch†

Code	Diode
Omit	None
R	Diode

Code	Body Material
Omit	Steel
A	Aluminum

Code	Port Size	Body Part No.
Omit	Cartridge Only	
4P	1/4" NPTF	(B08-3-*4P)
4T	SAE-4	(B08-3-*4T)
6T	SAE-6	(B08-3-*6T)
6B	3/8" BSPG	(B08-3-*6B)

* Add "A" for aluminum, omit for steel.

*Recommended
†DC Only



Pressure Drop vs. Flow (Through cartridge only)

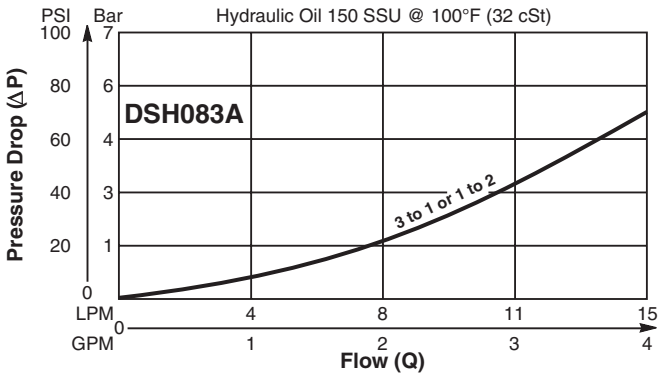

Shift Limit Characteristics (Min. Operating Voltage)

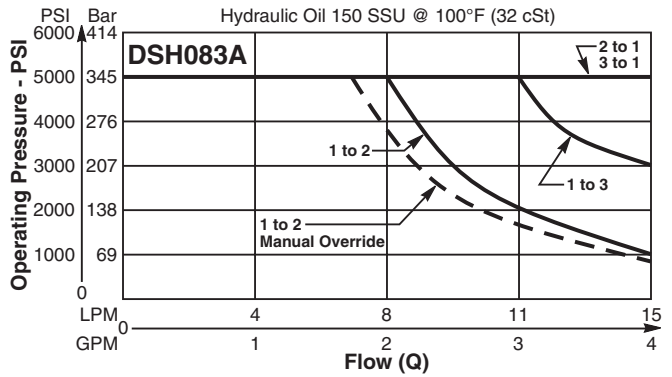

Pressure Drop vs. Flow (Through cartridge only)

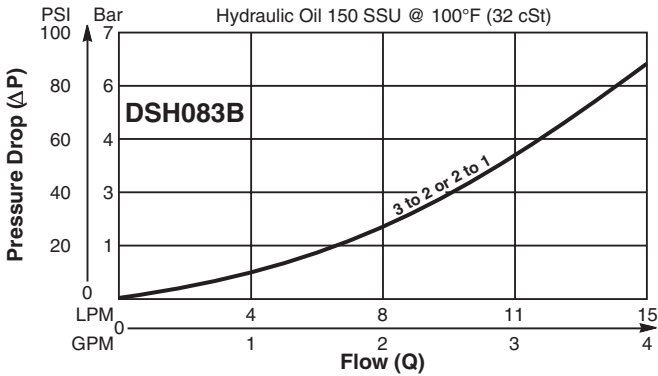

Shift Limit Characteristics (Min. Operating Voltage)

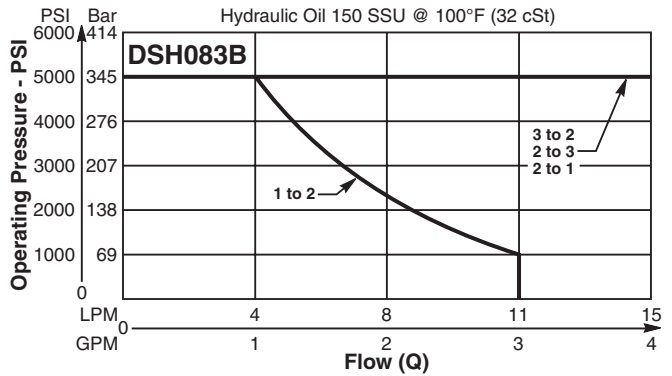

Pressure Drop vs. Flow (Through cartridge only)

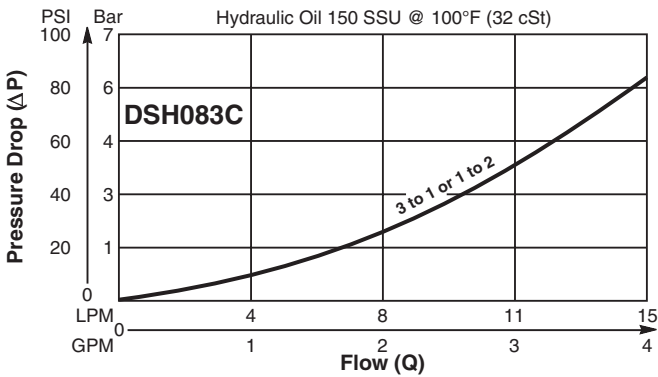

Shift Limit Characteristics (Min. Operating Voltage)

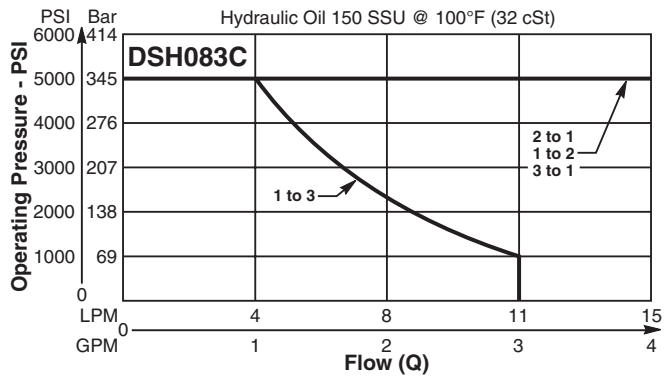

Pressure Drop vs. Flow (Through cartridge only)

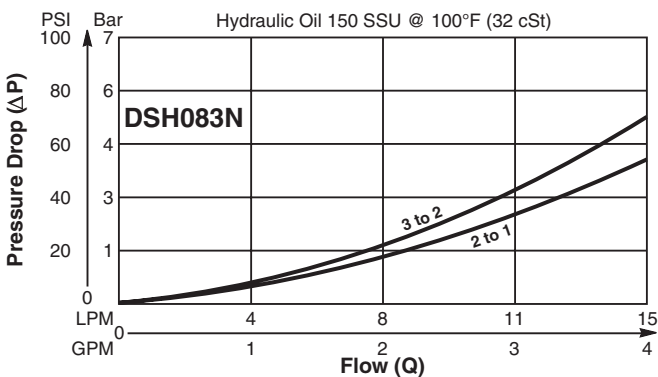

Shift Limit Characteristics (Min. Operating Voltage)

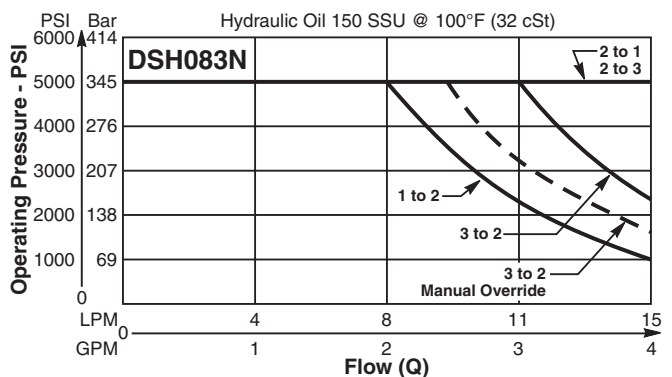

- CV** Check Valves
- SH** Shuttle Valves
- LM** Load/Motor Controls
- FC** Flow Controls
- PC** Pressure Controls
- LE** Logic Elements
- DC** Directional Controls
- MV** Manual Valves
- SV** Solenoid Valves
- PV** Proportional Valves
- CE** Coils & Electronics
- BC** Bodies & Cavities
- TD** Technical Data

Technical Information

- CV** Check Valves
- SH** Shuttle Valves
- LM** Load/Motor Controls
- FC** Flow Controls
- PC** Pressure Controls
- LE** Logic Elements
- DC** Directional Controls
- MV** Manual Valves
- SV** Solenoid Valves
- PV** Proportional Valves
- CE** Coils & Electronics
- BC** Bodies & Cavities
- TD** Technical Data

General Description

3-Way Spool Valves. For additional information see Technical Tips on pages SV1-SV6.



Features

- High flow capacity with reduced space requirements
- Standard valve bodies and common cavities
- One-piece encapsulated coil with minimal amperage draw
- Manual overrides, seal variations and other options available
- No dynamic seals
- Variety of coil terminations
- Polyurethane "D"-Ring
- All external parts zinc plated

Specifications

Rated Flow	DSL103A	N.O.	22.7 LPM (6.0 GPM)	
		N.C.	17.0 LPM (4.5 GPM)	
		Selector	17.0 LPM (4.5 GPM)	
	DSL103B	N.C.	30.2 LPM (8.0 GPM)	
		Selector	30.2 LPM (8.0 GPM)	
	DSL103C	N.O.	30.2 LPM (8.0 GPM)	
	DSL103N	N.O.	18.8 LPM (5.0 GPM)	
		N.C.	18.8 LPM (5.0 GPM)	
		Selector	30.2 LPM (8.0 GPM)	
	Maximum Inlet Pressure	250 Bar (3600 PSI)		
	Leakage at 150 SSU (32 cSt)	120 cc/min. (7.5 in ³ /min.) DSL103B - 180 cc/min. (11 in ³ /min.) DSL103N - 180 cc/min. (11 in ³ /min.)		
	Minimum Operating Voltage	85% of rated voltage at 20°C (72°F).		
Response Time	50 ms to 100 ms			
Cartridge Material	All parts steel. All operating parts hardened steel.			
Operating Temp. Range/Seals	-45°C to +93.3°C ("D"-Ring) (-50°F to +200°F) -31.7°C to +121.1°C (Fluorocarbon) (-25°F to +250°F)			
Fluid Compatibility/Viscosity	Mineral-based or synthetic with lubricating properties at viscosities of 45 to 2000 SSU (6 to 420 cSt)			
Filtration	ISO Code 16/13, SAE Class 4 or better			
Approx. Weight	.19 kg (.42 lbs.)			
Cavity	C10-3 (See BC Section for more details)			
Form Tool	Rougher	NFT10-3R		
	Finisher	NFT10-3F		

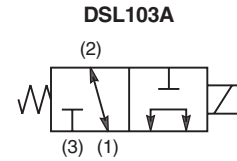

Construction/Symbols

DSL103A

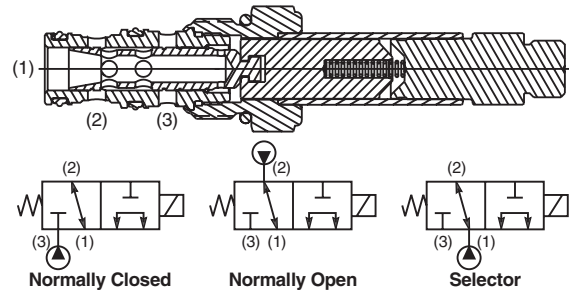

DSL103B

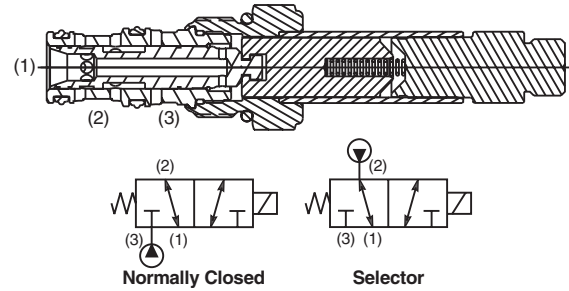

DSL103C

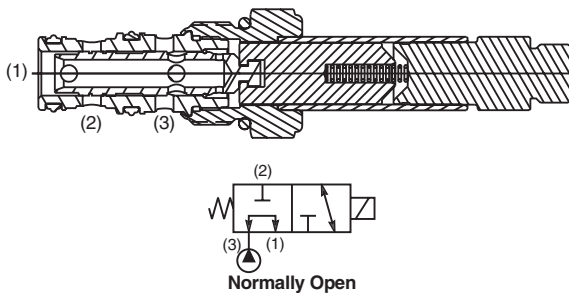

DSL103N

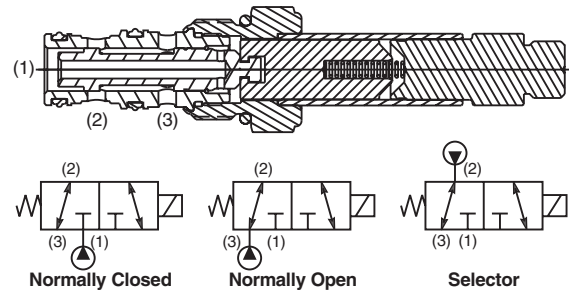

Dimensions Millimeters (Inches)

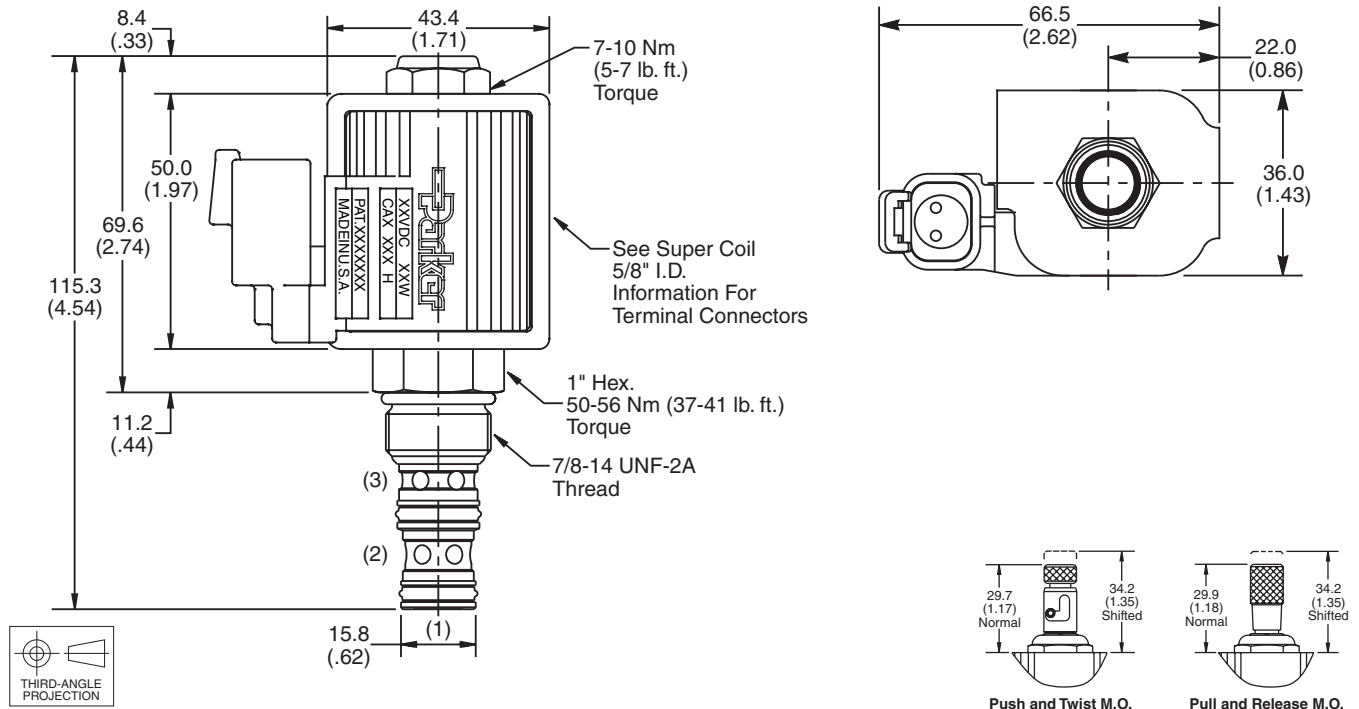

Ordering Information

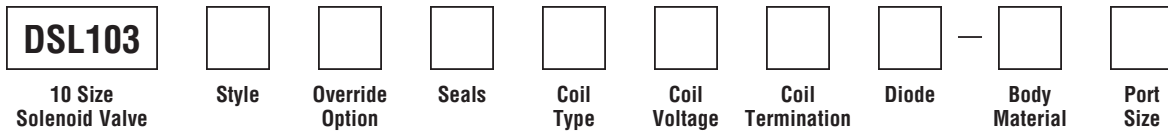

Code	Style
A	
B	
C	
N	

Code	Override Options
Omit	None
P	Pull & Release
T	Push & Twist

Code	Seals / Kit No.
Omit	"D"-Ring / (SK10-3)
N	Nitrile / (SK10-3N)
V	Fluorocarbon / (SK10-3V)

Code	Coil Type
Omit	Without Coil
SP*	Super Coil - 28 Watts

*Recommended

Code	Coil Voltage
Omit	Without Coil
D012	12 VDC
D024	24 VDC
A120	120/110 VAC, 60/50 Hz
A240	240/220 VAC, 60/50 Hz

SP*	Coil Termination
Omit	Without Coil
C	Conduit With Leads
D	DIN Plug Face
A	Amp Jr. Timert†
S	Dual Spade†
L	Dual Lead Wire†
LS	Sealed Lead Wire†
H	Molded Deutsch†

*Recommended
†DC Only

Code	Diode
Omit	None
R	Diode

Code	Body Material
Omit	Steel
A	Aluminum

Code	Port Size	Body Part No.
Omit	Cartridge Only	
4P	1/4" NPTF	(B10-3-*4P)
6P	3/8" NPTF	(B10-3-*6P)
8P	1/2" NPTF	(B10-3-*8P)
6T	SAE-6	(B10-3-*6T)
8T	SAE-8	(B10-3-*8T)
6B	3/8" BSPG	(B10-3-6B)†
8B	1/2" BSPG	(B10-3-*8B)

* Add "A" for aluminum, omit for steel.
† Steel bodies only.

- CV** Check Valves
- SH** Shuttle Valves
- LM** Load/Motor Controls
- FC** Flow Controls
- PC** Pressure Controls
- LE** Logic Elements
- DC** Directional Controls
- MV** Manual Valves
- SV** Solenoid Valves
- PV** Proportional Valves
- CE** Coils & Electronics
- BC** Bodies & Cavities
- TD** Technical Data

Pressure Drop vs. Flow (Through cartridge only)

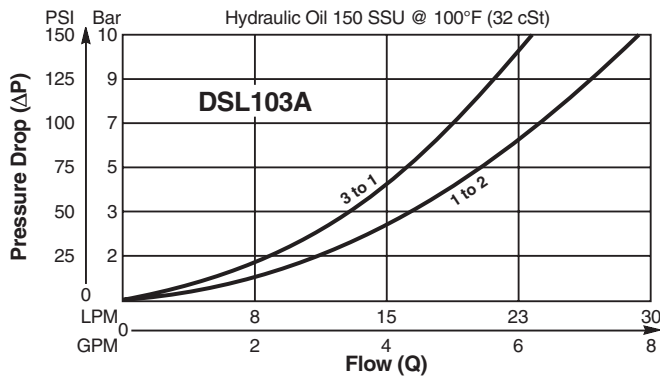

Shift Limit Characteristics (Min. Operating Voltage)

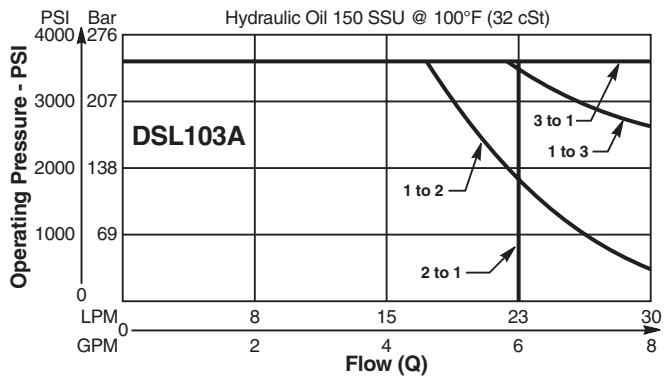

Pressure Drop vs. Flow (Through cartridge only)

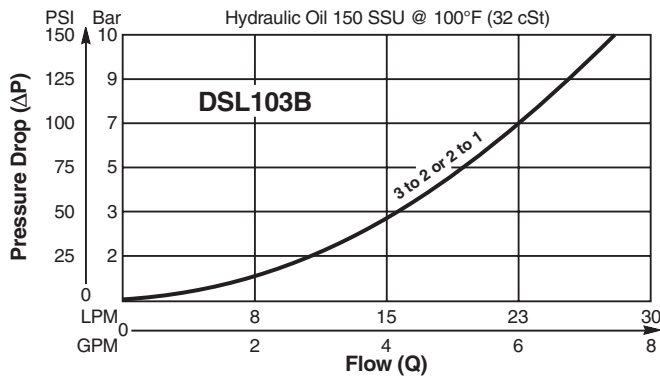

Shift Limit Characteristics (Min. Operating Voltage)

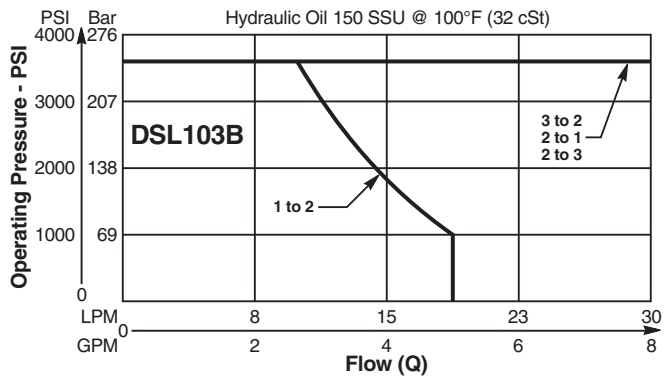

Pressure Drop vs. Flow (Through cartridge only)

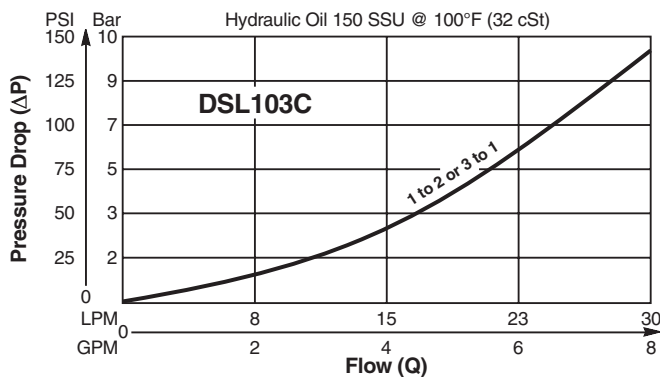

Shift Limit Characteristics (Min. Operating Voltage)

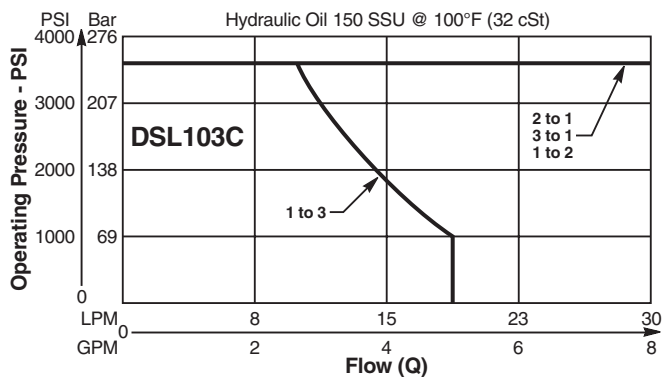

Pressure Drop vs. Flow (Through cartridge only)

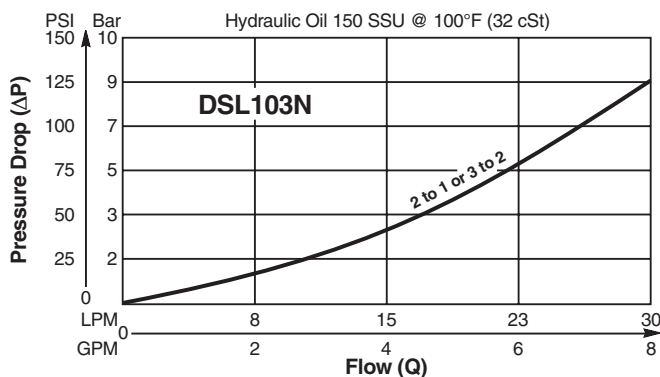

Shift Limit Characteristics (Min. Operating Voltage)

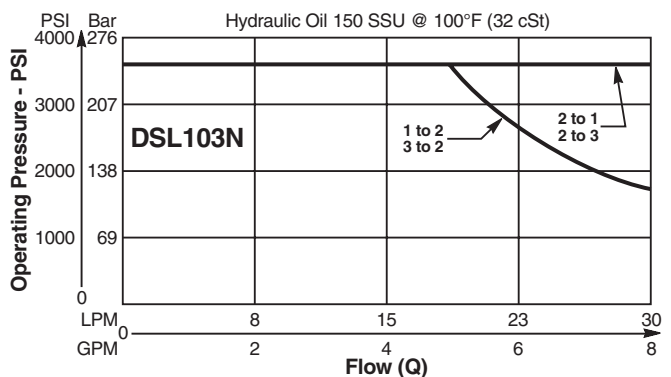

Technical Information

General Description

3-Way Spool Valves. For additional information see Technical Tips on pages SV1-SV6.



Features

- High flow capacity with reduced space requirements
- Standard valve bodies and common cavities
- One-piece encapsulated coil with minimal amperage draw
- Manual overrides, seal variations and other options available
- No dynamic seals
- Variety of coil terminations
- Polyurethane "D"-Ring eliminates need for backup rings
- Nylon inserted jam-nut provides secure holding in high vibration applications
- All external parts zinc plated

Specifications

Rated Flow	DSH103A	N.O.	17.0 LPM (4.5 GPM)
		N.C.	15.0 LPM (4.0 GPM)
		Selector	15.0 LPM (4.0 GPM)
	DSH103B	N.C.	30.0 LPM (8.0 GPM)
		Selector	30.0 LPM (8.0 GPM)
	DSH103C	N.O.	30.0 LPM (8.0 GPM)
	DSH103N	N.O.	15.0 LPM (4.0 GPM)
		N.C.	15.0 LPM (4.0 GPM)
		Selector	30.0 LPM (8.0 GPM)
	Maximum Inlet Pressure	350 Bar (5000 PSI)	
Leakage at 150 SSU (32 cSt)	160 cc/min. (10 in ³ /min.) DSH103B - 250 cc/min. (15 in ³ /min.) DSH103N - 250 cc/min. (15 in ³ /min.)		
Minimum Operating Voltage	85% of rated voltage at 20°C (72°F).		
Response Time	50 ms to 100 ms		
Cartridge Material	All parts steel. All operating parts hardened steel.		
Operating Temp. Range/Seals	-45°C to +93.3°C ("D"-Ring) (-50°F to +200°F) -31.7°C to +121.1°C (Fluorocarbon) (-25°F to +250°F)		
Fluid Compatibility/Viscosity	Mineral-based or synthetic with lubricating properties at viscosities of 45 to 2000 SSU (6 to 420 cSt)		
Filtration	ISO Code 16/13, SAE Class 4 or better		
Approx. Weight	.19 kg (.42 lbs.)		
Cavity	C10-3 (See BC Section for more details)		
Form Tool	Rougher	NFT10-3R	
	Finisher	NFT10-3F	

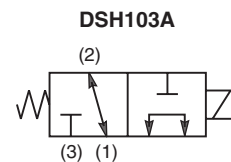

Construction/Symbols

DSH103A

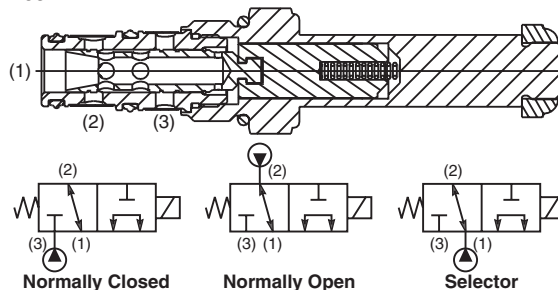

DSH103B

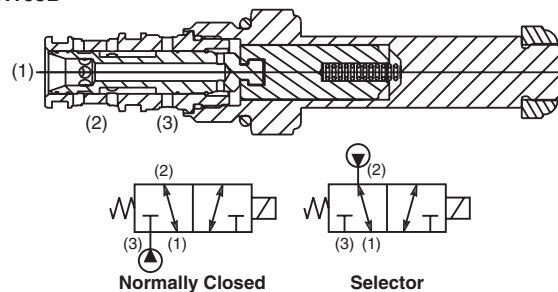

DSH103C

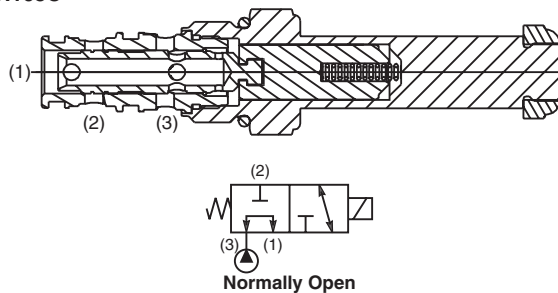

DSH103N

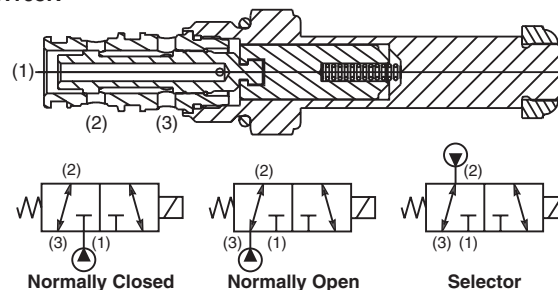

CV Check Valves

SH Shuttle Valves

LM Load/Motor Controls

FC Flow Controls

PC Pressure Controls

LE Logic Elements

DC Directional Controls

MV Manual Valves

SV Solenoid Valves

PV Proportional Valves

CE Coils & Electronics

BC Bodies & Cavities

TD Technical Data

Spool Type, 3-Way Valve Series DSH103

Dimensions Millimeters (Inches)

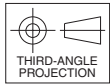
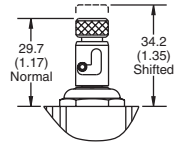
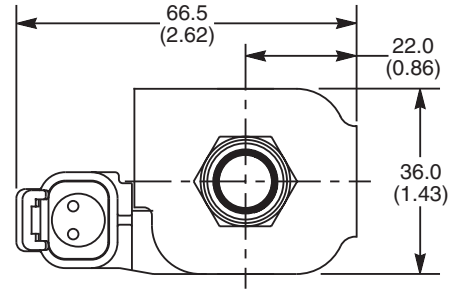
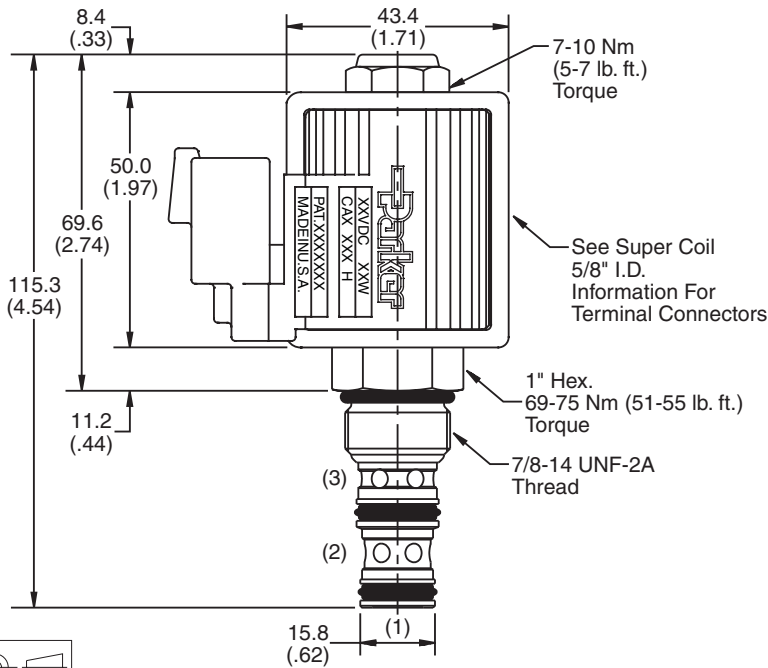

Ordering Information

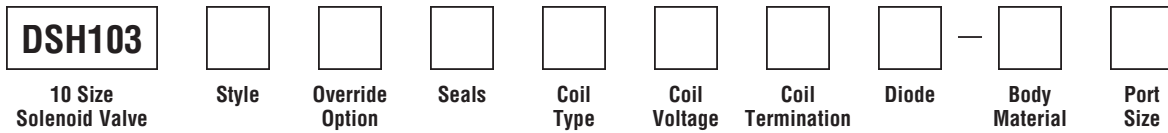

Code	Style
A	
B	
C	
N	

Code	Override Options
Omit	None
T	Push & Twist (N.C. & N.O.)

Code	Seals / Kit No.
Omit	"D"-Ring / (SK10-3)
N	Nitrile / (SK10-3N)
V	Fluorocarbon / (SK10-3V)

Code	Coil Type
Omit	Without Coil
SP*	Super Coil - 28 Watts

*Recommended

Code	Coil Voltage
Omit	Without Coil
D012	12 VDC
D024	24 VDC
A120	120/110 VAC, 60/50 Hz
A240	240/220 VAC, 60/50 Hz

SP*	Coil Termination
Omit	Without Coil
C	Conduit With Leads
D	DIN Plug Face
A	Amp Jr. Timert†
S	Dual Spade†
L	Dual Lead Wire†
LS	Sealed Lead Wire†
H	Molded Deutsch†

*Recommended
†DC Only

Code	Diode
Omit	None
R	Diode

Code	Body Material
Omit	Steel
A	Aluminum

Code	Port Size	Body Part No.
Omit	Cartridge Only	
4P	1/4" NPTF	(B10-3-*4P)
6P	3/8" NPTF	(B10-3-*6P)
8P	1/2" NPTF	(B10-3-*8P)
6T	SAE-6	(B10-3-*6T)
8T	SAE-8	(B10-3-*8T)
6B	3/8" BSPG	(B10-3-6B)†
8B	1/2" BSPG	(B10-3-*8B)

* Add "A" for aluminum, omit for steel.
† Steel bodies only.

Pressure Drop vs. Flow (Through cartridge only)

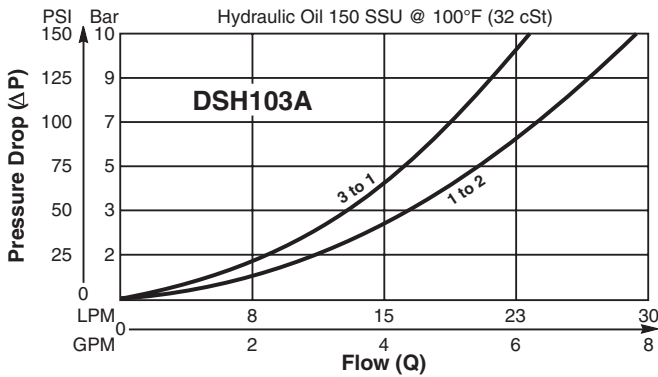

Shift Limit Characteristics (Min. Operating Voltage)

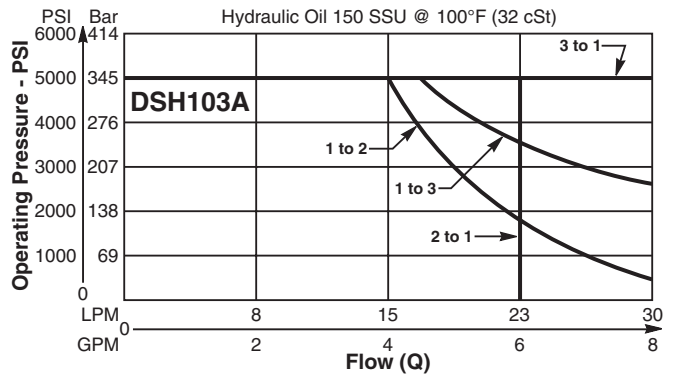

Pressure Drop vs. Flow (Through cartridge only)

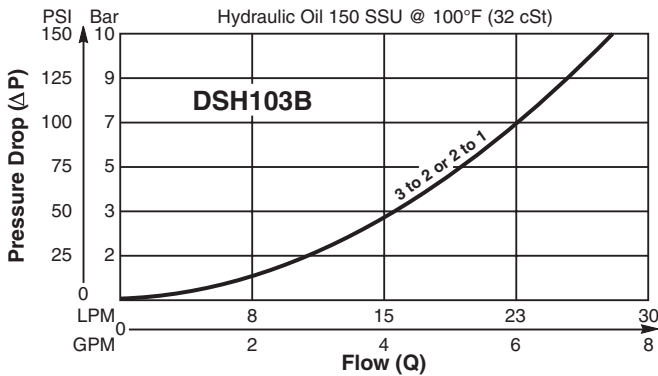

Shift Limit Characteristics (Min. Operating Voltage)

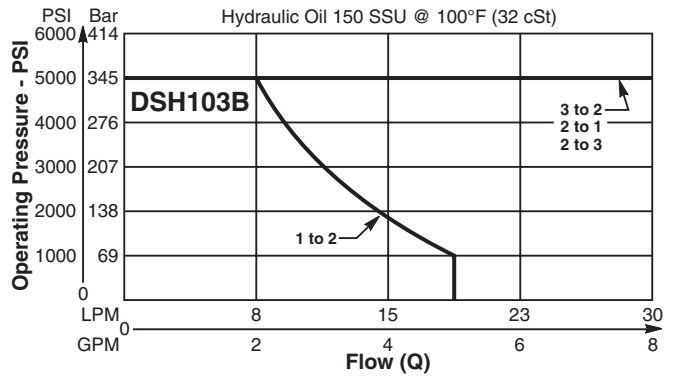

Pressure Drop vs. Flow (Through cartridge only)

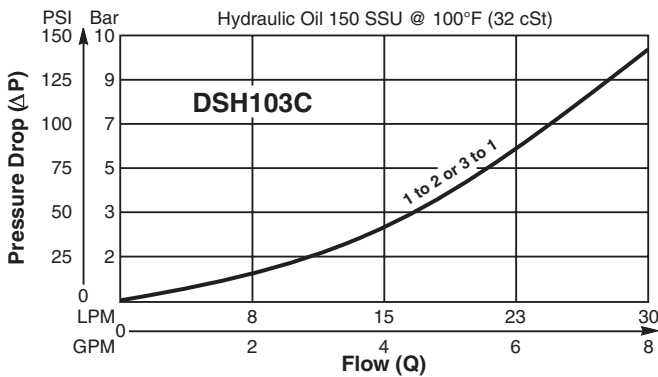

Shift Limit Characteristics (Min. Operating Voltage)

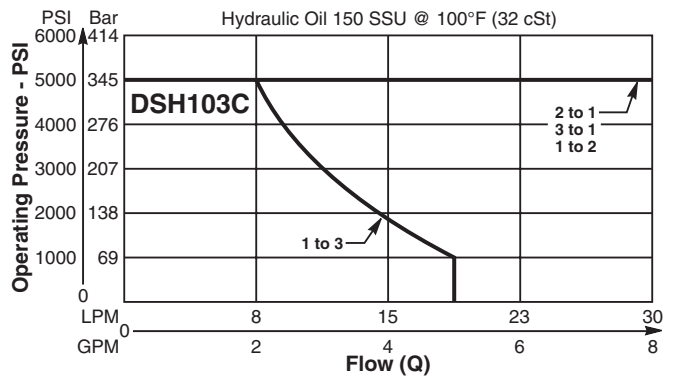

Pressure Drop vs. Flow (Through cartridge only)

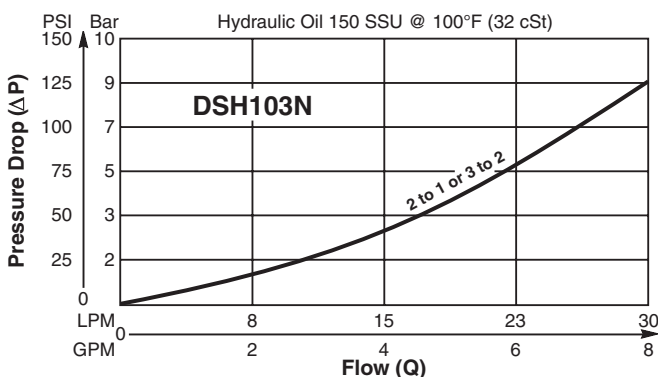

Shift Limit Characteristics (Min. Operating Voltage)

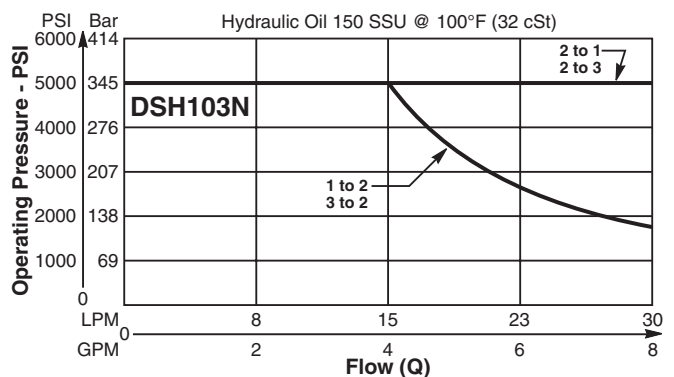

- CV** Check Valves
- SH** Shuttle Valves
- LM** Load/Motor Controls
- FC** Flow Controls
- PC** Pressure Controls
- LE** Logic Elements
- DC** Directional Controls
- MV** Manual Valves
- SV** Solenoid Valves
- PV** Proportional Valves
- CE** Coils & Electronics
- BC** Bodies & Cavities
- TD** Technical Data

Technical Information

- CV** Check Valves
- SH** Shuttle Valves
- LM** Load/Motor Controls
- FC** Flow Controls
- PC** Pressure Controls
- LE** Logic Elements
- DC** Directional Controls
- MV** Manual Valves
- SV** Solenoid Valves
- PV** Proportional Valves
- CE** Coils & Electronics
- BC** Bodies & Cavities
- TD** Technical Data

General Description

3-Way Spool Valves. For additional information see Technical Tips on pages SV1-SV6.

Features

- High flow capacity with reduced space requirements
- Standard valve bodies and common cavities
- One-piece encapsulated coil with minimal amperage draw
- No dynamic seals
- Variety of coil terminations
- All external parts zinc plated
- Manual override standard

Specifications

Rated Flow	DS163	N.O. 45.4 LPM (12 GPM)
		N.C. 49.2 LPM (13 GPM)
		Selector 41.6 LPM (11 GPM)
DS163B	N.O. 26.5 LPM (7 GPM)	
	N.C. 53.0 LPM (14 GPM)	
	Selector 56.8 LPM (15 GPM)	
Maximum Inlet Pressure	210 Bar (3000 PSI)	
Leakage at 150 SSU (32 cSt)	82 cc/min. (5 in ³ /min.)	
Minimum Operating Voltage	85% of rated voltage at 20°C (72°F).	
Response Time	Normally Closed up to 90 ms Normally Open up to 100 ms	
Cartridge Material	All parts steel. All operating parts hardened steel.	
Operating Temp. Range/Seals	-40°C to +93.3°C (Nitrile) (-40°F to +200°F) -31.7°C to +121.1°C (Fluorocarbon) (-25°F to +250°F)	
Fluid Compatibility/ Viscosity	Mineral-based or synthetic with lubricating properties at viscosities of 45 to 2000 SSU (6 to 420 cSt)	
Filtration	ISO Code 16/13, SAE Class 4 or better	
Approx. Weight	.59 kg (1.3 lbs.)	
Cavity	C16-3 (See BC Section for more details)	
Form Tool	Rougher	NFT16-3R
	Finisher	NFT16-3F

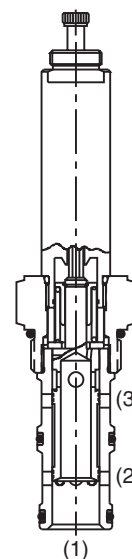
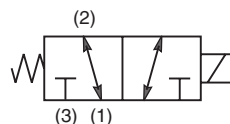
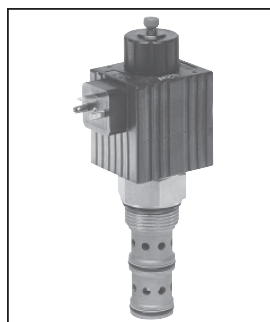

DS163

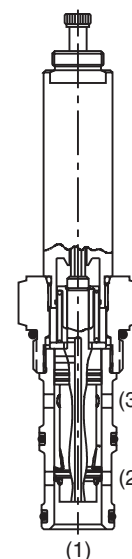

DS163B

Dimensions Millimeters (Inches)

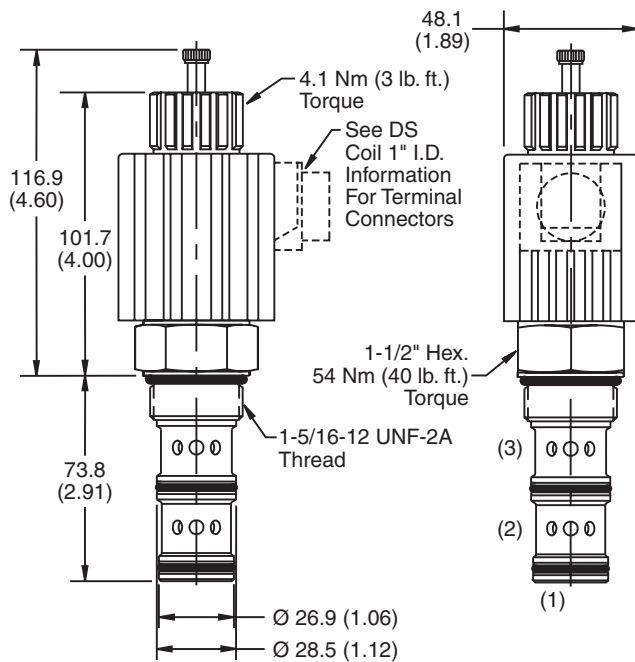

Performance Curves

Pressure Drop vs. Flow (Through cartridge only)

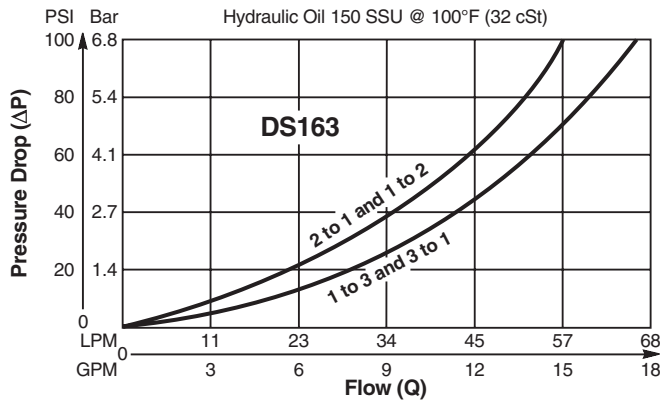

Shift Limit Characteristics (Min. Operating Voltage)

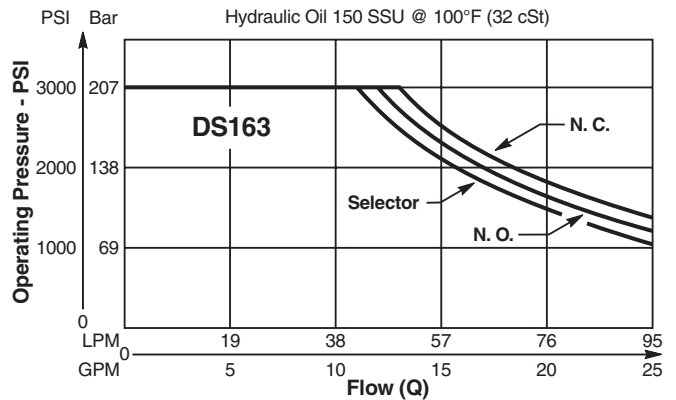

Pressure Drop vs. Flow (Through cartridge only)

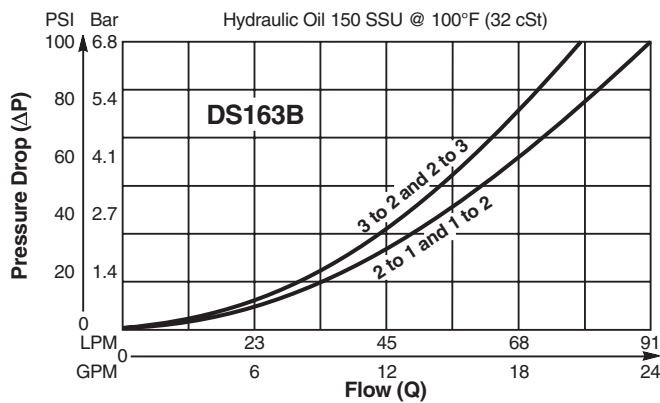

Shift Limit Characteristics (Min. Operating Voltage)

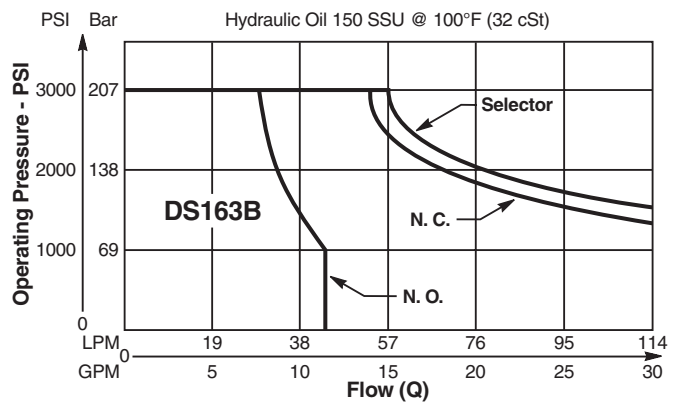

Ordering Information

DS163

16 Size Solenoid Valve **Style** **Seals** **Coil Voltage** **Coil Termination** **Body Material** **Port Size**

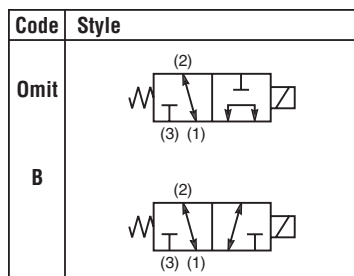

Code	Seals / Kit No.
Omit	Nitrile / (SK16-3)
V	Fluorocarbon / (SK16-3V)

Code	Coil Voltage
Omit	Without Coil
D012	12 VDC
D024	24 VDC
A120	120/110 VAC, 60/50 Hz

Code	Coil Termination
Omit	Without Coil
C	Conduit (AC Only)
D	DIN Plug Face
S	Dual Screw (DC Only)
W	Dual Lead (DC Only)

See DS coil 1" I.D. (42 watt)

Code	Body Material
Omit	Steel
A	Aluminum

Code	Port Size	Body Part No.
Omit	Cartridge Only	
12T	SAE-12	(B16-3-*12T)
16T	SAE-16	(B16-3-*16T)

** Add "A" for aluminum, omit for steel.*



- CV** Check Valves
- SH** Shuttle Valves
- LM** Load/Motor Controls
- FC** Flow Controls
- PC** Pressure Controls
- LE** Logic Elements
- DC** Directional Controls
- MV** Manual Valves
- SV** Solenoid Valves
- PV** Proportional Valves
- CE** Coils & Electronics
- BC** Bodies & Cavities
- TD** Technical Data

Technical Information

- CV** Check Valves
- SH** Shuttle Valves
- LM** Load/Motor Controls
- FC** Flow Controls
- PC** Pressure Controls
- LE** Logic Elements
- DC** Directional Controls
- MV** Manual Valves
- SV** Solenoid Valves
- PV** Proportional Valves
- CE** Coils & Electronics
- BC** Bodies & Cavities
- TD** Technical Data

General Description

4-Way Spool Valves. For additional information see Technical Tips on pages SV1-SV6.



Features

- High flow capacity with reduced space requirements
- Standard valve bodies and common cavities
- One-piece encapsulated coil with minimal amperage draw
- Manual overrides, seal variations and other options available
- No dynamic seals
- Variety of coil terminations
- Polyurethane "D"-Ring eliminates need for backup rings
- Nylon inserted jam-nut provides secure holding in high vibration applications
- All external parts zinc plated



DSL084B

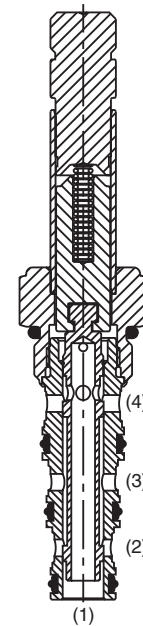
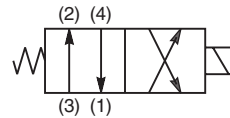

DSL084B

Specifications

Rated Flow	11-15 LPM (3-4 GPM)
Maximum Inlet Pressure	250 Bar (3600 PSI)
Leakage at 150 SSU (32 cSt)	160 cc/min. (10 in ³ /min.) at 250 Bar (3600 PSI)
Minimum Operating Voltage	85% of rated voltage at 20°C (72°F).
Response Time	Energized - 50 ms De-energized - 30 ms
Cartridge Material	All parts steel. All operating parts hardened steel.
Operating Temp. Range/Seals	-45°C to +93.3°C ("D"-Ring) (-50°F to +200°F) -31.7°C to +121.1°C (Fluorocarbon) (-25°F to +250°F)
Fluid Compatibility/Viscosity	Mineral-based or synthetic with lubricating properties at viscosities of 45 to 2000 SSU (6 to 420 cSt)
Filtration	ISO Code 16/13, SAE Class 4 or better
Approx. Weight	.13 kg (.29 lbs.)
Cavity	C08-4 (See BC Section for more details)
Form Tool	Rougher NFT08-4R Finisher NFT08-4F

Curve Selection Chart

SPOOL CODE	NEUTRAL					SHIFTED			
	4 to 1	3 to 2	2 to 1	3 to 1	3 to 4	4 to 1	3 to 2	2 to 1	3 to 4
B	4	3	—	—	—	—	—	2	4
E1	—	—	—	—	—	—	—	2	3
M	—	—	3	—	1	—	—	—	—
N	—	—	—	—	—	4	3	—	—

Performance Curves

Pressure Drop vs. Flow (Through cartridge only)

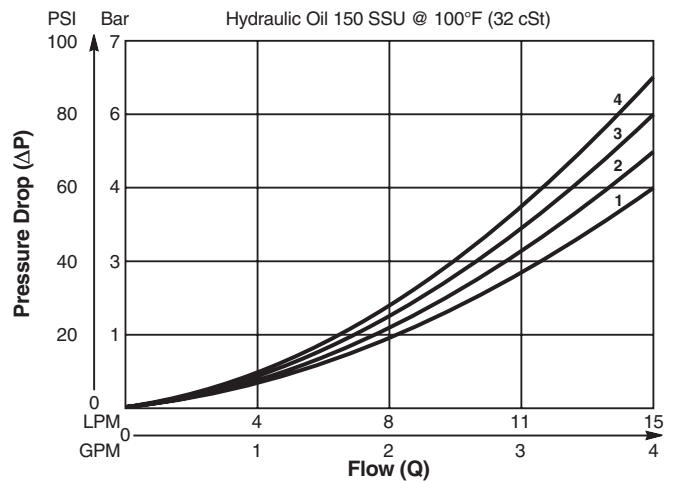

Shift Limit Characteristics (Min. Operating Voltage)

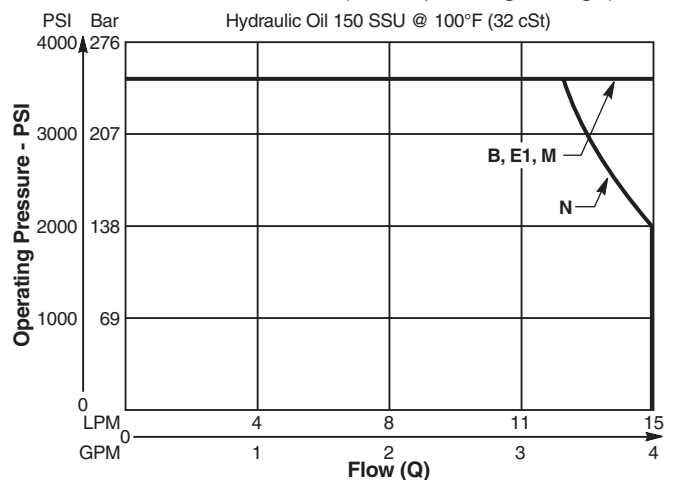

Dimensions Millimeters (Inches)

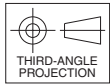
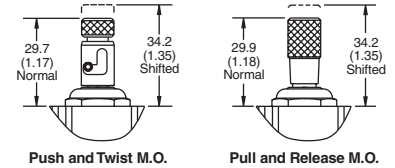
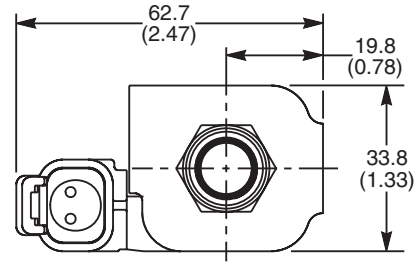
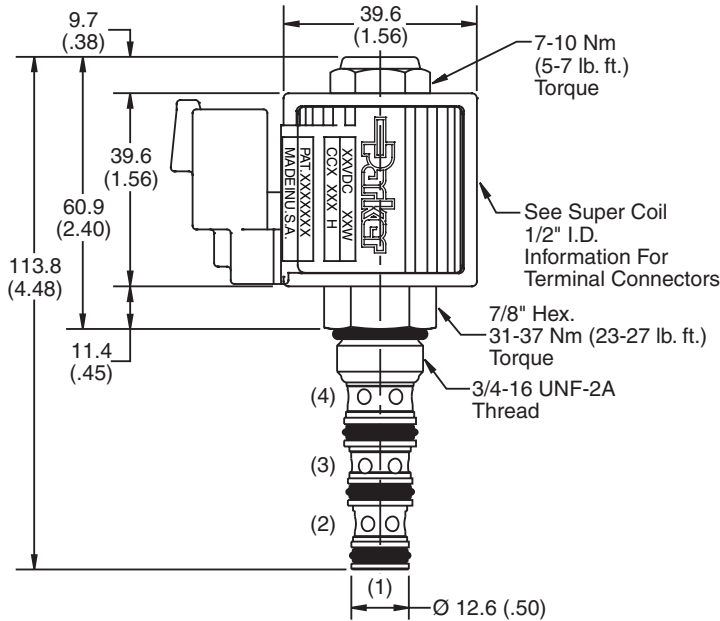

Ordering Information

DSL084

08 Size Solenoid Valve **Style** **Override Option** **Seals** **Coil Type** **Coil Voltage** **Coil Termination** **Diode** **Body Material** **Port Size**

Code	Style
B	
N	
E1	
M	

Code	Override Options
Omit	None
P	Pull & Release
T	Push & Twist

Code	Seals / Kit No.
Omit	"D"-Ring / (SK08-4)
N	Nitrile / (SK08-4N)
V	Fluorocarbon / (SK08-4V)

Code	Coil Type
Omit	Without Coil
SP*	Super Coil - 19 Watts

*Recommended

Code	Coil Voltage
Omit	Without Coil
D012	12 VDC
D024	24 VDC
A120	120/110 VAC, 60/50 Hz
A240	240/220 VAC, 60/50 Hz

SP*	Coil Termination
Omit	Without Coil
C	Conduit With Leads
D	DIN Plug Face
A	Amp Jr. Timert
S	Dual Spade†
L	Dual Lead Wire†
LS	Sealed Lead Wire†
H	Molded Deutsch†

*Recommended
†DC Only

Code	Diode
Omit	None
R	Diode

Code	Body Material
Omit	Steel
A	Aluminum

Code	Port Size	Body Part No.
Omit	Cartridge Only	
4T	SAE-4	(B08-4-*4T)
6T	SAE-6	(B08-4-*6T)
6B	3/8" BSPG	(B08-4-*6B)

* Add "A" for aluminum, omit for steel.

Technical Information

- CV** Check Valves
- SH** Shuttle Valves
- LM** Load/Motor Controls
- FC** Flow Controls
- PC** Pressure Controls
- LE** Logic Elements
- DC** Directional Controls
- MV** Manual Valves
- SV** Solenoid Valves
- PV** Proportional Valves
- CE** Coils & Electronics
- BC** Bodies & Cavities
- TD** Technical Data

General Description

4-Way Spool Valves. For additional information see Technical Tips on pages SV1-SV6.



Features

- High flow capacity with reduced space requirements
- Standard valve bodies and common cavities
- One-piece encapsulated coil with minimal amperage draw
- Manual overrides, seal variations and other options available
- No dynamic seals
- Variety of coil terminations
- Polyurethane "D"-Ring eliminates need for backup rings
- Nylon inserted jam-nut provides secure holding in high vibration applications
- All external parts zinc plated

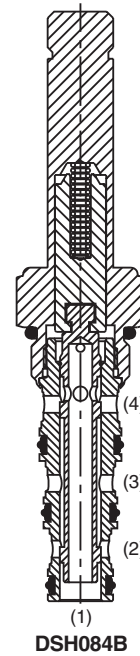
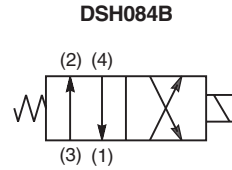

Specifications

Rated Flow	11-15 LPM (3-4 GPM)
Max. Inlet Pressure	350 Bar (5000 PSI)
Leakage at 150 SSU (32 cSt)	160 cc/min. (10 in ³ /min.) at 350 Bar (5000 PSI) DSH084B - 240 cc/min. (15 in ³ /min.)
Minimum Operating Voltage	85% of rated voltage at 20°C (72°F).
Response Time	Energized - 50 ms De-energized - 30 ms
Cartridge Material	All parts steel. All operating parts hardened steel.
Operating Temp. Range/Seals	-45°C to +93.3°C ("D"-Ring) (-50°F to +200°F) -31.7°C to +121.1°C (Fluorocarbon) (-25°F to +250°F)
Fluid Compatibility/Viscosity	Mineral-based or synthetic with lubricating properties at viscosities of 45 to 2000 SSU (6 to 420 cSt)
Filtration	ISO Code 16/13, SAE Class 4 or better
Approx. Weight	.13 kg (.29 lbs.)
Cavity	C08-4 (See BC Section for more details)
Form Tool	Rougher NFT08-4R Finisher NFT08-4F

Curve Selection Chart

SPOOL CODE	NEUTRAL					SHIFTED				
	4 to 1	3 to 2	2 to 1	3 to 1	3 to 4	4 to 1	3 to 2	2 to 1	3 to 4	
B	4	3	—	—	—	—	—	2	4	
E1	—	—	—	—	—	—	—	2	3	
M	—	—	3	—	1	—	—	—	—	
N	—	—	—	—	—	4	3	—	—	

Performance Curves

Pressure Drop vs. Flow (Through cartridge only)

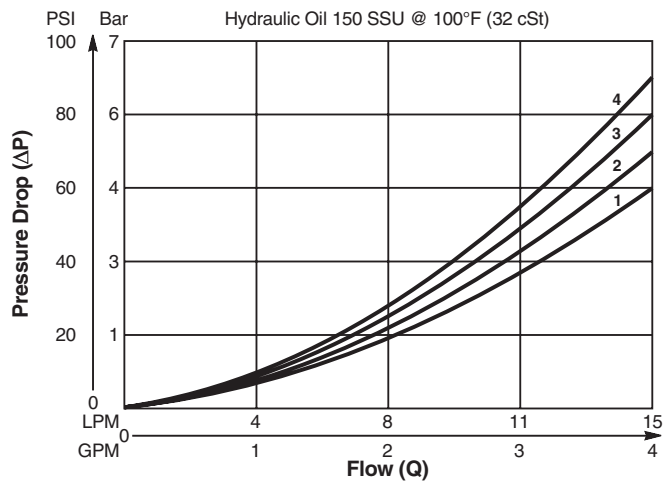

Shift Limit Characteristics (Min. Operating Voltage)

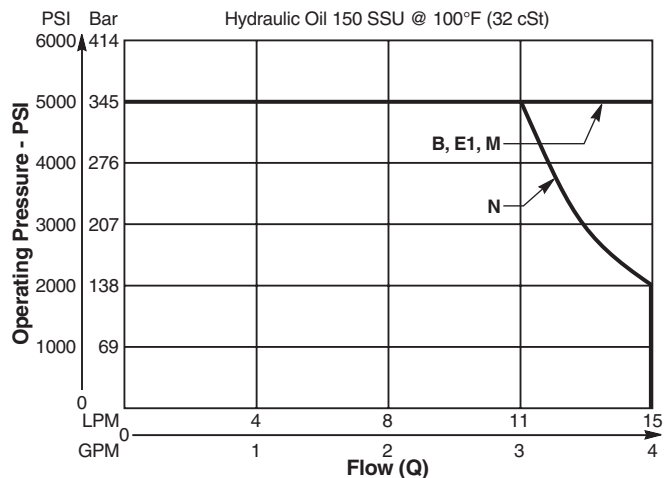

Dimensions Millimeters (Inches)

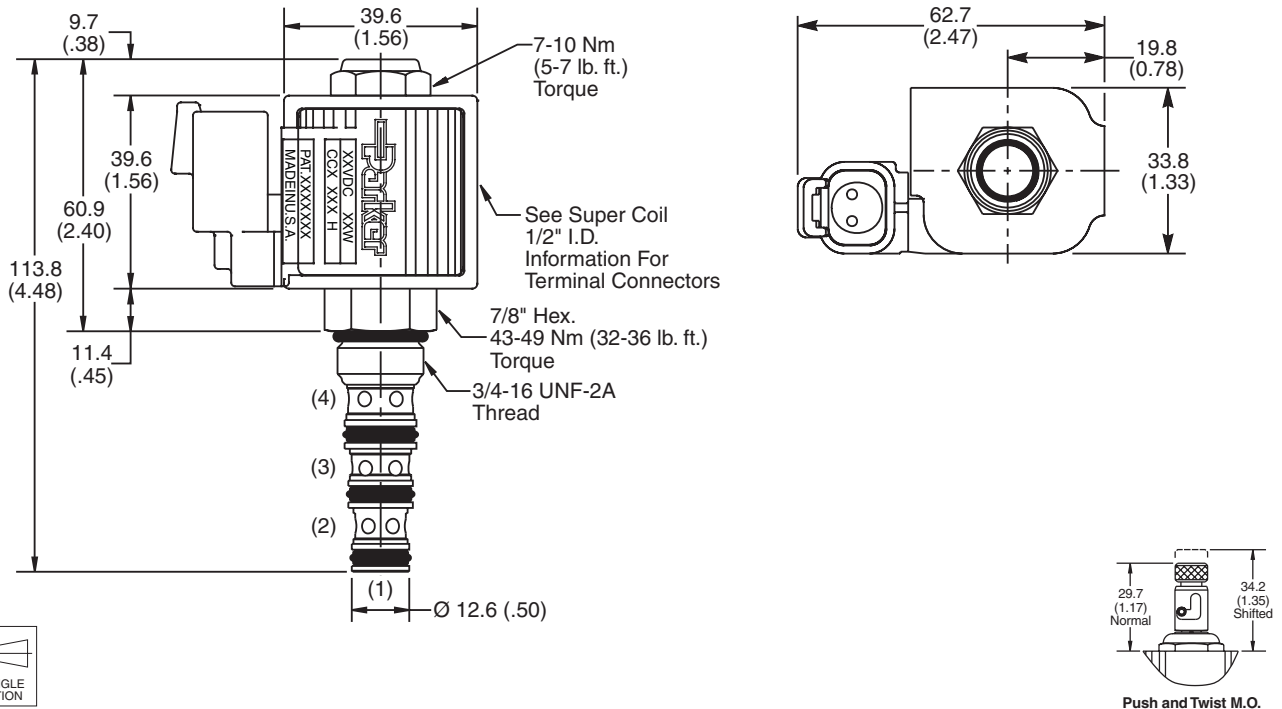

Ordering Information

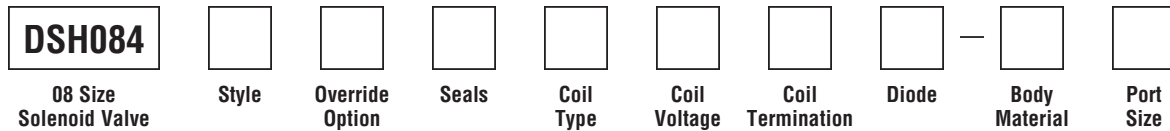

Code	Style
B	
N	
E1	
M	

Code	Override Options
Omit	None
T	Push & Twist*

**Requires Super Coil*

Code	Seals / Kit No.
Omit	"D"-Ring / (SK08-4)
N	Nitrile / (SK08-4N)
V	Fluorocarbon / (SK08-4V)

Code	Coil Type
Omit	Without Coil
SP*	Super Coil - 19 Watts

**Recommended*

Code	Coil Voltage
Omit	Without Coil
D012	12 VDC
D024	24 VDC
A120	120/110 VAC, 60/50 Hz
A240	240/220 VAC, 60/50 Hz

SP*	Coil Termination
Omit	Without Coil
C	Conduit With Leads
D	DIN Plug Face
A	Amp Jr. Timert
S	Dual Spade†
L	Dual Lead Wire†
LS	Sealed Lead Wire†
H	Molded Deutsch†

**Recommended
†DC Only*

Code	Diode
Omit	None
R	Diode

Code	Body Material
Omit	Steel
A	Aluminum

Code	Port Size	Body Part No.
Omit	Cartridge Only	
4T	SAE-4	(B08-4-*4T)
6T	SAE-6	(B08-4-*6T)
6B	3/8" BSPG	(B08-4-*6B)

** Add "A" for aluminum, omit for steel.*

Technical Information

- CV** Check Valves
- SH** Shuttle Valves
- LM** Load/Motor Controls
- FC** Flow Controls
- PC** Pressure Controls
- LE** Logic Elements
- DC** Directional Controls
- MV** Manual Valves
- SV** Solenoid Valves
- PV** Proportional Valves
- CE** Coils & Electronics
- BC** Bodies & Cavities
- TD** Technical Data

General Description

4-Way Spool Valves. For additional information see Technical Tips on pages SV1-SV6.



Features

- High flow capacity with reduced space requirements
- Standard valve bodies and common cavities
- One-piece encapsulated coil with minimal amperage draw
- Manual overrides, seal variations and other options available
- No dynamic seals
- Variety of coil terminations
- Polyurethane "D"-Ring
- All external parts zinc plated

Specifications

Rated Flow	27-38 LPM (7-10 GPM) See Shift Limit Characteristics
Maximum Inlet Pressure	250 Bar (3600 PSI)
Leakage at 150 SSU (32 cSt)	230 cc/min (14 in ³ /min)
Minimum Operating Voltage	85% of rated voltage at 20°C (72°F).
Response Time	Energized - 30 - 60 ms De-energized - 30 - 60 ms
Cartridge Material	All parts steel. All operating parts hardened steel.
Operating Temp. Range/Seals	-45°C to +93.3°C ("D"-Ring) (-50°F to +200°F) -31.7°C to +121.1°C (Fluorocarbon) (-25°F to +250°F)
Fluid Compatibility/Viscosity	Mineral-based or synthetic with lubricating properties at viscosities of 45 to 2000 SSU (6 to 420 cSt)
Filtration	ISO Code 16/13, SAE Class 4 or better
Approx. Weight	.20 kg (.44 lbs.)
Cavity	C10-4 (See BC Section for more details)
Form Tool	Rougher NFT10-4R Finisher NFT10-4F



DSL104B

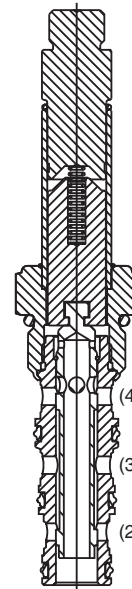
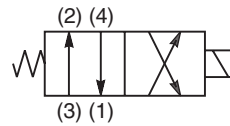

DSL104B

Performance Curves

Pressure Drop vs. Flow (Through cartridge only)

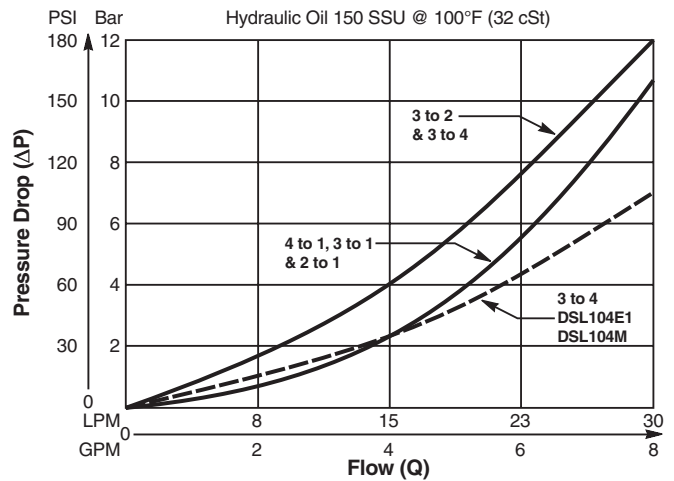

Shift Limit Characteristics (Min. Operating Voltage)

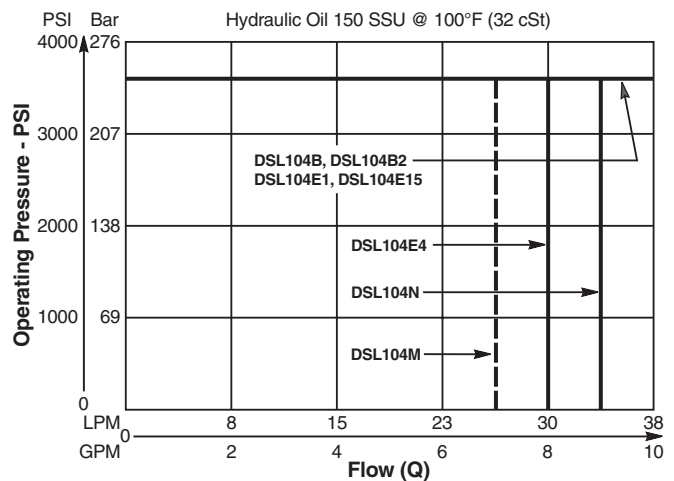

Dimensions Millimeters (Inches)

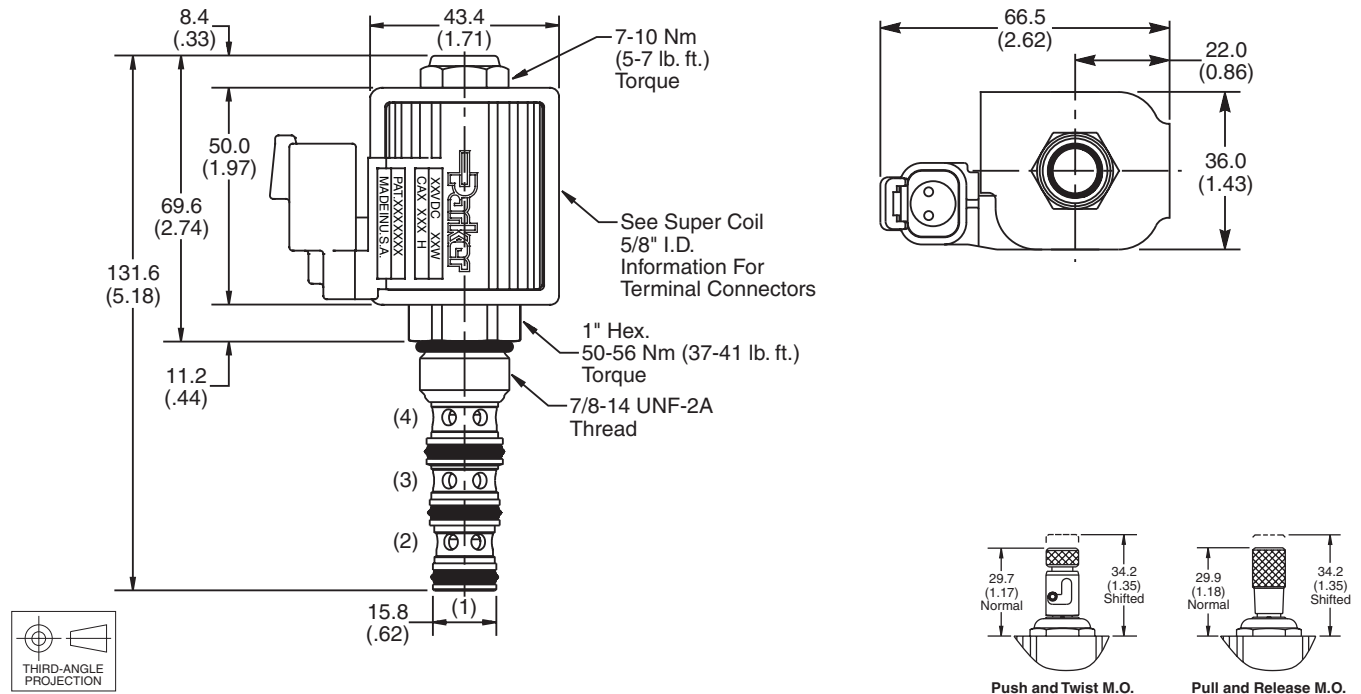

Ordering Information

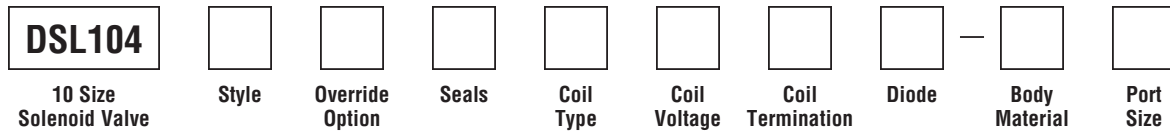

Code	Style
B	
B2	
E1	
E4	
E15	
M	
N	

Code	Override Options
Omit	None
P	Pull & Release
T	Push & Twist

Code	Seals / Kit No.
Omit	"D"-Ring / (SK10-4)
N	Nitrile / (SK10-4N)
V	Fluorocarbon / (SK10-4V)

Code	Coil Type
Omit	Without Coil
SP*	Super Coil - 28 Watts

*Recommended

Code	Coil Voltage
Omit	Without Coil
D012	12 VDC
D024	24 VDC
A120	120/110 VAC, 60/50 Hz
A240	240/220 VAC, 60/50 Hz

SP*	Coil Termination
Omit	Without Coil
C	Conduit With Leads
D	DIN Plug Face
A	Amp Jr. Timert†
S	Dual Spade†
L	Dual Lead Wire†
LS	Sealed Lead Wire†
H	Molded Deutsch†

*Recommended
 †DC Only

Code	Diode
Omit	None
R	Diode

Code	Body Material
Omit	Steel
A	Aluminum

Code	Port Size	Body Part No.
Omit	Cartridge Only	
6P	3/8" NTPF	(B10-4-*6P)
6T	SAE-6	(B10-4-*6T)
8T	SAE-8	(B10-4-*8T)
6B	3/8" BSPG	(B10-4-6B)†

* Add "A" for aluminum, omit for steel.
 † Steel bodies only

Technical Information

- CV** Check Valves
- SH** Shuttle Valves
- LM** Load/Motor Controls
- FC** Flow Controls
- PC** Pressure Controls
- LE** Logic Elements
- DC** Directional Controls
- MV** Manual Valves
- SV** Solenoid Valves
- PV** Proportional Valves
- CE** Coils & Electronics
- BC** Bodies & Cavities
- TD** Technical Data

General Description

4-Way Spool Valves. For additional information see Technical Tips on pages SV1-SV6.



Features

- High flow capacity with reduced space requirements
- Standard valve bodies and common cavities
- One-piece encapsulated coil with minimal amperage draw
- Manual overrides, seal variations and other options available
- No dynamic seals
- Variety of coil terminations
- Polyurethane "D"-Ring eliminates need for backup rings
- Nylon inserted jam-nut provides secure holding in high vibration applications
- All external parts zinc plated

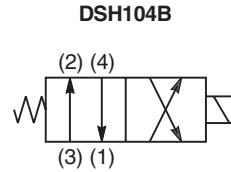
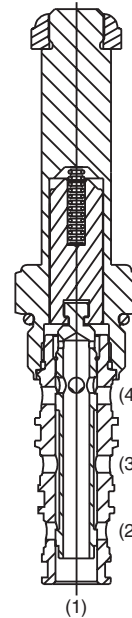

Specifications

Rated Flow	25 - 38 LPM (6.5 - 10 GPM) See Shift Limit Characteristics
Maximum Inlet Pressure	350 Bar (5000 PSI)
Leakage at 150 SSU (32 cSt)	160 cc/min (10 in ³ /min) DSH104B - 320 cc/min (19.5 in ³ /min)
Minimum Operating Voltage	85% of rated voltage at 20°C (72°F).
Response Time	Energized - 30 - 60 ms De-energized - 30 - 60 ms
Cartridge Material	All parts steel. All operating parts hardened steel.
Operating Temp. Range/Seals	-45°C to +93.3°C ("D"-Ring) (-50°F to +200°F) -31.7°C to +121.1°C (Fluorocarbon) (-25°F to +250°F)
Fluid Compatibility/Viscosity	Mineral-based or synthetic with lubricating properties at viscosities of 45 to 2000 SSU (6 to 420 cSt)
Filtration	ISO Code 16/13, SAE Class 4 or better
Approx. Weight	.20 kg (.44 lbs.)
Cavity	C10-4 (See BC Section for more details)
Form Tool	Rougher NFT10-4R Finisher NFT10-4F

Performance Curves

Pressure Drop vs. Flow (Through cartridge only)

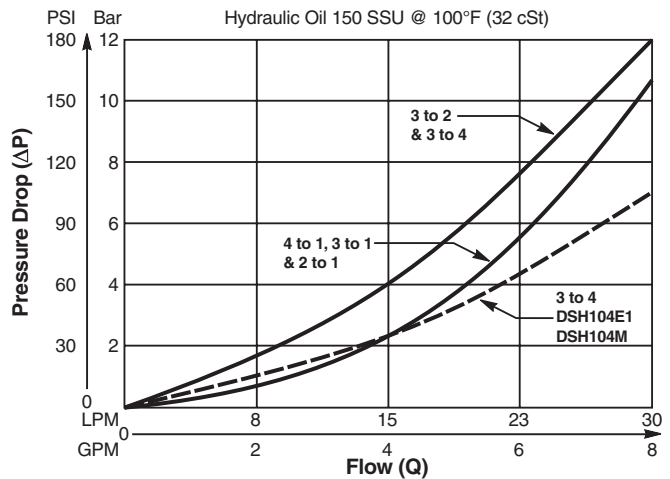

Shift Limit Characteristics (Min. Operating Voltage)

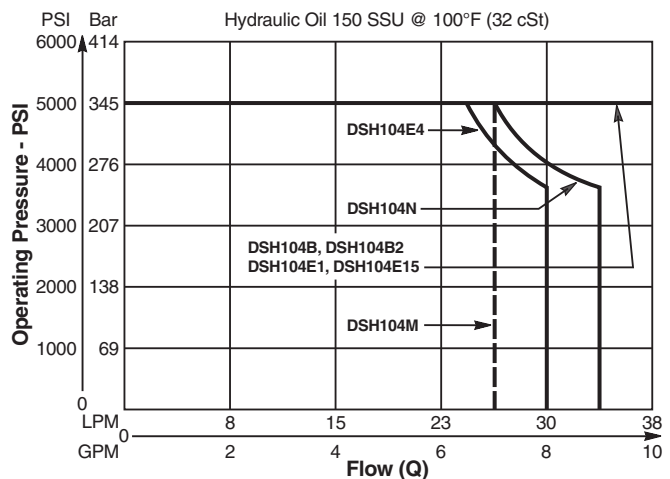

Dimensions Millimeters (Inches)

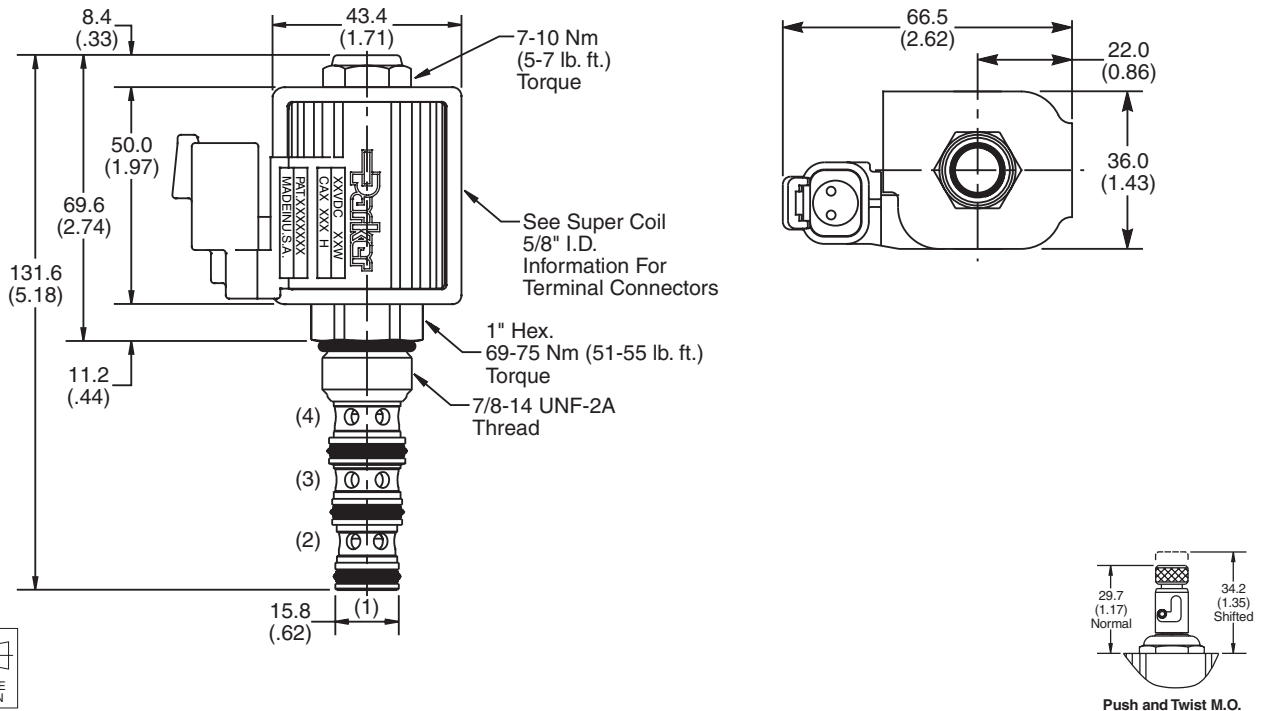

Ordering Information

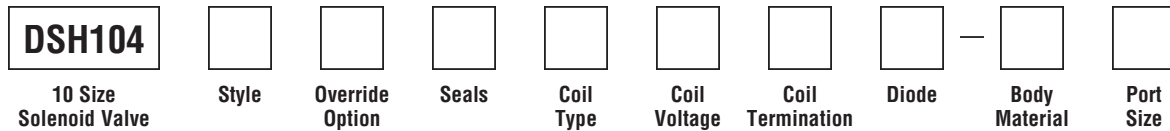

Code	Style
B	
B2	
E1	
E4	
E15	
M	
N	

Code	Override Options
Omit	None
T	Push & Twist

Code	Seals / Kit No.
Omit	"D"-Ring / (SK10-4)
N	Nitrile / (SK10-4N)
V	Fluorocarbon / (SK10-4V)

Code	Coil Type
Omit	Without Coil
SP*	Super Coil - 28 Watts

*Recommended

Code	Coil Voltage
Omit	Without Coil
D012	12 VDC
D024	24 VDC
A120	120/110 VAC, 60/50 Hz
A240	240/220 VAC, 60/50 Hz

SP*	Coil Termination
Omit	Without Coil
C	Conduit With Leads
D	DIN Plug Face
A	Amp Jr. Timert
S	Dual Spade†
L	Dual Lead Wire†
LS	Sealed Lead Wire†
H	Molded Deutsch†

*Recommended
 †DC Only

Code	Diode
Omit	None
R	Diode

Code	Body Material
Omit	Steel
A	Aluminum

Code	Port Size	Body Part No.
Omit	Cartridge Only	
6P	3/8" NTPF	(B10-4-*6P)
6T	SAE-6	(B10-4-*6T)
8T	SAE-8	(B10-4-*8T)
6B	3/8" BSPG	(B10-4-6B)†

* Add "A" for aluminum, omit for steel.
 † Steel bodies only

Technical Information

CV

Check Valves

SH

Shuttle Valves

LM

Load/Motor Controls

FC

Flow Controls

PC

Pressure Controls

LE

Logic Elements

DC

Directional Controls

MV

Manual Valves

SV

Solenoid Valves

PV

Proportional Valves

CE

Coils & Electronics

BC

Bodies & Cavities

TD

Technical Data

General Description

4-Way Spool Valves. For additional information see Technical Tips on pages SV1-SV6.

Features

- High flow capacity with reduced space requirements
- Standard valve bodies and common cavities
- One-piece encapsulated coil with minimal amperage draw
- Seal variations and other options available
- No dynamic seals
- Variety of coil terminations
- Nylon inserted jam-nut provides secure holding in high vibration applications
- All external parts zinc plated

Application Note

This valve is a pilot operated spool type valve. It does not require a separate pilot supply, but does require that the work port pressure or the inlet pressure is 40-60 psi higher than port 1. In an open flowing condition, with zero load and low flow, it will require a 4-6 gpm flow to create internal pilot pressure to shift. If load pressure or system pressure is 40-60 psi higher than tank, the valve will shift. Ultimately, the valve shifts based upon pressure differential from port 3 to port 1 of 40-60 psi.

Specifications

Rated Flow	114 LPM (30 GPM)
Maximum Inlet Pressure	350 Bar (5000 PSI)
Leakage at 150 SSU (32 cSt)	350 cc/min (21 in ³ /min) De-Energ. 5.6 LPM (1.5 GPM) Energized Pilot Flow @ 207 Bar (3000 PSI)
Minimum Operating Voltage	85% of rated voltage at 20°C (72°F).
Response Time	Pull In - 600 ms Drop Out - 130 ms
Cartridge Material	All parts steel. All operating parts hardened steel.
Operating Temp. Range/Seals	-40°C to +93.3°C (Nitrile) (-40°F to +200°F) -31.7°C to +121.1°C (Fluorocarbon) (-25°F to +250°F)
Fluid Compatibility/Viscosity	Mineral-based or synthetic with lubricating properties at viscosities of 45 to 2000 SSU (6 to 420 cSt)
Filtration	ISO Code 16/13, SAE Class 4 or better
Approx. Weight	.59 kg (1.3 lbs.)
Cavity	C16-4 (See BC Section for more details)
Form Tool	Rougher NFT16-4R Finisher NFT16-4F

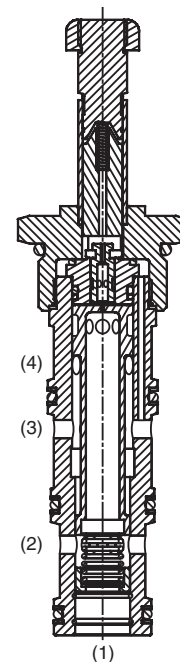
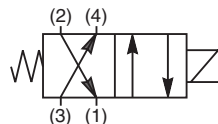

Performance Curves

Pressure Drop vs. Flow (Through cartridge only)

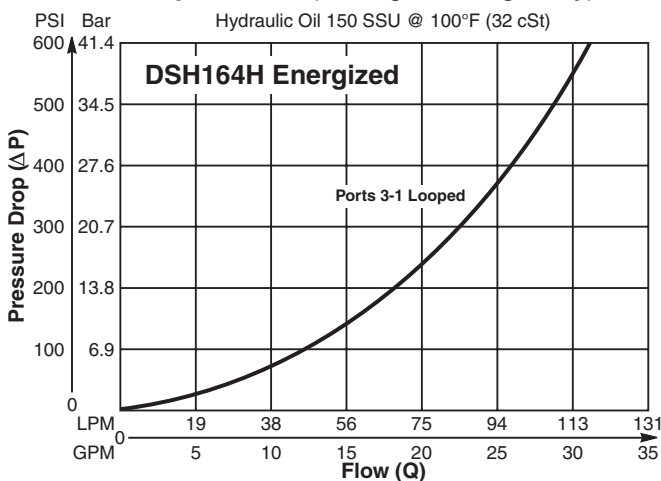

Pressure Drop vs. Flow (Through cartridge only)

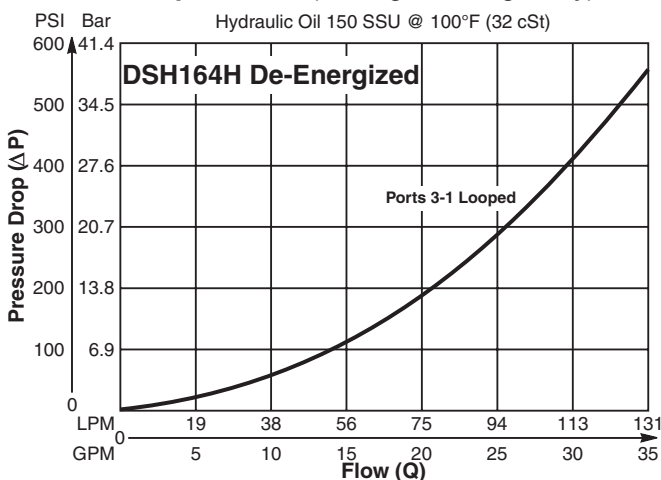

Technical Information

Dimensions Millimeters (Inches)

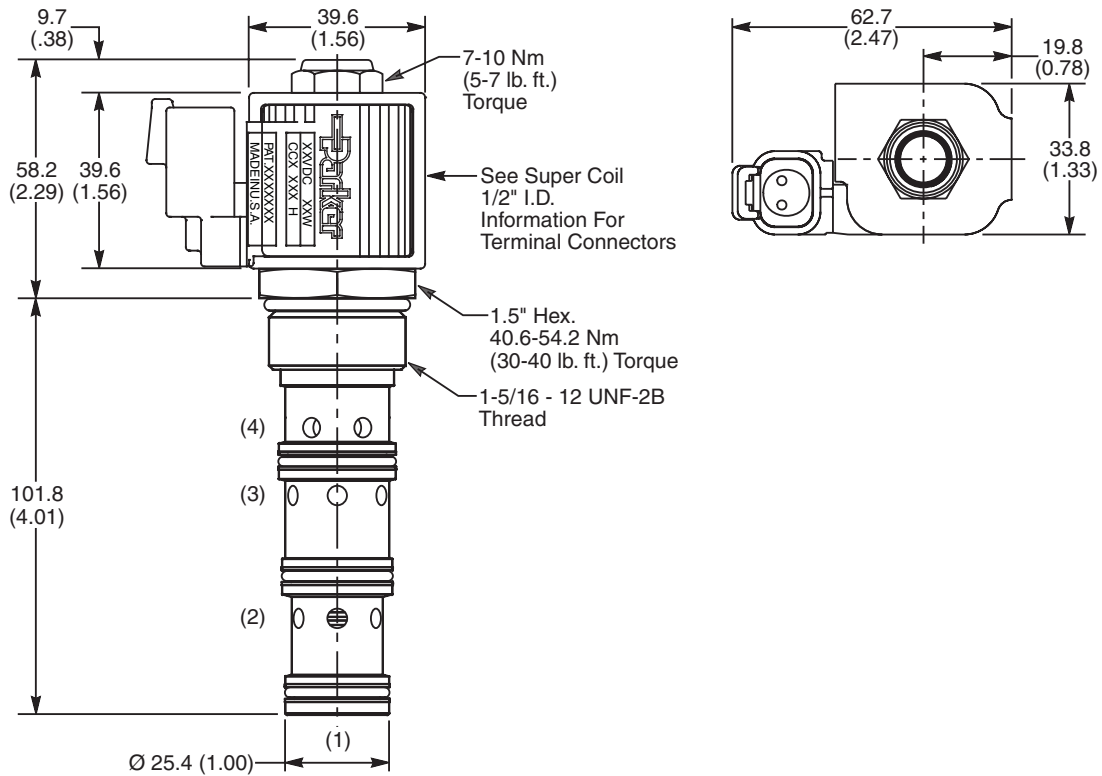

Ordering Information

DSH164 **H**

16 Size Solenoid Valve Style Seals Coil Type Coil Voltage Coil Termination Diode Body Material Port Size

Code	Style
H	

Code	Coil Type
Omit	Without Coil
SP*	Super Coil - 19 Watts

**Recommended*

SP* Coil	Coil Termination
Omit	Without Coil
C	Conduit With Leads
D	DIN Plug Face
A	Amp Jr. Timer†
S	Dual Spade†
L	Dual Lead Wire†
LS	Sealed Lead Wire†
H	Molded Deutsch†

Code	Diode
Omit	None
R	Diode

Code	Seals / Kit No.
N	Nitrile / (SK10-4N)
V	Fluorocarbon / (SK10-4V)

Code	Coil Voltage
Omit	Without Coil
D012	12 VDC
D024	24 VDC
A120	120/110 VAC, 60/50 Hz
A240	240/220 VAC, 60/50 Hz

Code	Body Material
Omit	Steel
A	Aluminum

Code	Port Size	Body Part No.
Omit	Cartridge Only	
16T	SAE-16	(B16-4-*16T)

**Recommended*
†DC Only

** Add "A" for aluminum, omit for steel.*

Technical Information

- CV** Check Valves
- SH** Shuttle Valves
- LM** Load/Motor Controls
- FC** Flow Controls
- PC** Pressure Controls
- LE** Logic Elements
- DC** Directional Controls
- MV** Manual Valves
- SV** Solenoid Valves
- PV** Proportional Valves
- CE** Coils & Electronics
- BC** Bodies & Cavities
- TD** Technical Data

General Description

4-Way, 3 Position, Closed Center Spool Valve.
For additional information see Technical Tips on pages SV1-SV6.

Features

- Designed to operate double acting cylinders, pilot circuits and bi-directional motors, etc.
- High flow capacity with reduced space requirements
- High pressure capability to 350 Bar (5000 PSI)
- One piece cartridge housing ensures internal concentricity
- Coil: Waterproof, hermetically sealed, requires no O’Rings; Symmetrical coil can be reversed without affecting performance.
- Manual override available

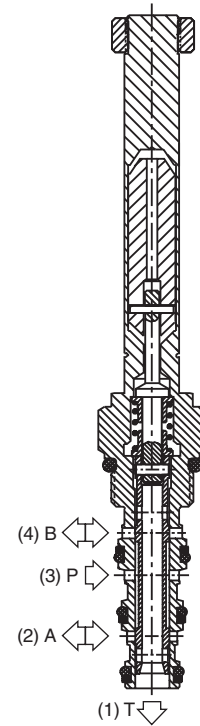
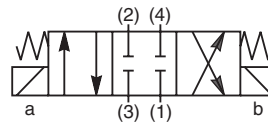

Specifications

Rated Flow (At 70 PSI ΔP)	High Flow/Pressure ('SP' Coil) 17 LPM (4.5 GPM)
Maximum Inlet Pressure	'SP' Coil 350 Bar (5000 PSI)
Maximum Tank Pressure	210 Bar (3000 PSI)
Cartridge Material	All parts steel. All operating parts hardened steel.
Operating Temp. Range/Seals	-40°C to +93.3°C (Nitrile) (-40°F to +200°F) -31.7°C to +121.1°C (Fluorocarbon) (-25°F to +250°F)
Fluid Compatibility/ Viscosity	Mineral-based or synthetic with lubricating properties at viscosities of 45 to 2000 SSU (6 to 420 cSt)
Filtration	ISO Code 16/13, SAE Class 4 or better
Approx. Weight	.18 kg (.40 lbs.)
Cavity	C08-4 (See BC Section for more details)

Performance Curves

Pressure Drop vs. Flow (Through cartridge only)

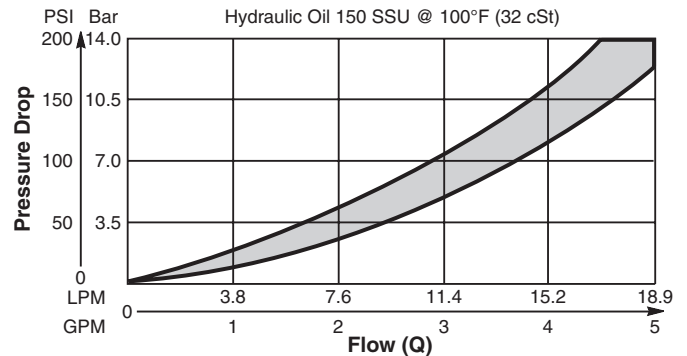

Operating Limits (Measured at 75% of Nominal Current)

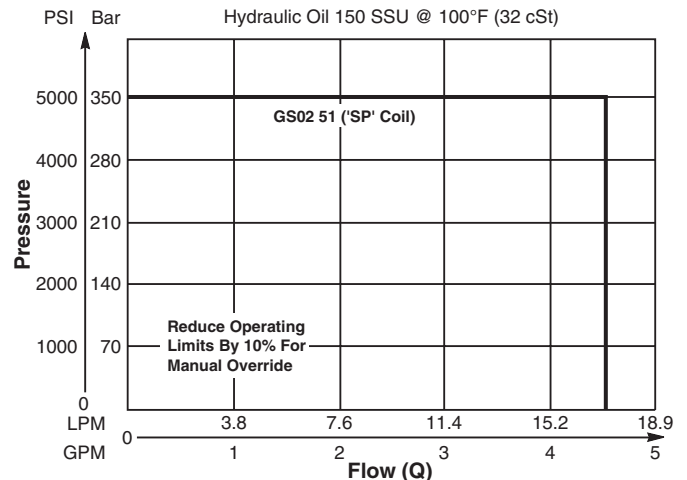

Dimensions Millimeters (Inches)

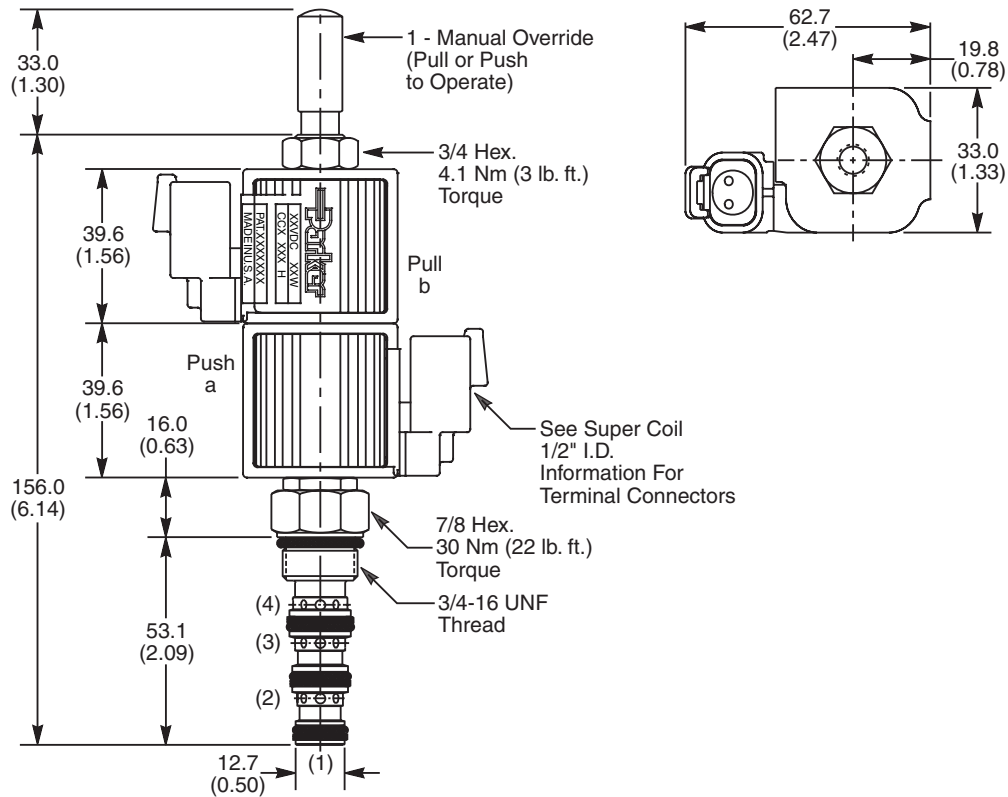

Ordering Information

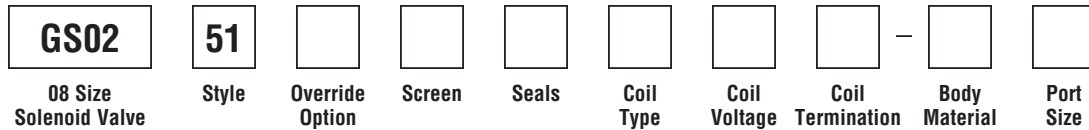

Code	Style
51	High Flow and Pressure ('SP' Coil)

Code	Override Options
0	Not Required
1	Manual Override
2	Detented M.O.

Code	Screen
0	Not Available

Code	Seals / Kit No.
N	Nitrile / Buna-N (Std.) (SK30078N-1)
V	Fluorocarbon / (SK30078V-1)

Code	Coil Type
Omit	Without Coil
SP	Super Coil - 19 Watts

Code	Coil Voltage
Omit	Without Coil
D012	12 VDC
D024	24 VDC
A120	120 VAC, 60/50 Hz
A240	240 VAC, 60/50 Hz*

*22 Watts

Code	Coil Termination
Omit	Without Coil
C	Conduit With Leads
D	DIN Plug Face
A	Amp Jr. Timer*
S	Dual Spade*
L	Dual Lead Wire*
SL	Sealed Lead Wire*
H	Molded Deutsch*

See Super Coil 1/2" I.D.
*DC Only

Code	Body Material
Omit	Steel
A	Aluminum

Code	Port Size	Body Part No.
Omit	Cartridge Only	
6T	SAE-6	(B08-4-*6T)
6B	3/8" BSPG	(B08-4-*6B)

* Add "A" for aluminum, omit for steel.

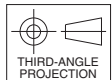

- CV Check Valves
- SH Shuttle Valves
- LM Load/Motor Controls
- FC Flow Controls
- PC Pressure Controls
- LE Logic Elements
- DC Directional Controls
- MV Manual Valves
- SV Solenoid Valves
- PV Proportional Valves
- CE Coils & Electronics
- BC Bodies & Cavities
- TD Technical Data

Technical Information

- CV** Check Valves
- SH** Shuttle Valves
- LM** Load/Motor Controls
- FC** Flow Controls
- PC** Pressure Controls
- LE** Logic Elements
- DC** Directional Controls
- MV** Manual Valves
- SV** Solenoid Valves
- PV** Proportional Valves
- CE** Coils & Electronics
- BC** Bodies & Cavities
- TD** Technical Data

General Description

4-Way, 3 Position, Floating Center Spool Valve.
For additional information see Technical Tips on pages SV1-SV6.

Features

- Designed to operate double acting cylinders, pilot circuits and bi-directional motors, etc.
- High flow capacity with reduced space requirements
- High pressure capability to 350 Bar (5000 PSI)
- One piece cartridge housing ensures internal concentricity
- Coil: Waterproof, hermetically sealed, requires no O’Rings; Symmetrical coil can be reversed without affecting performance.
- Manual override available

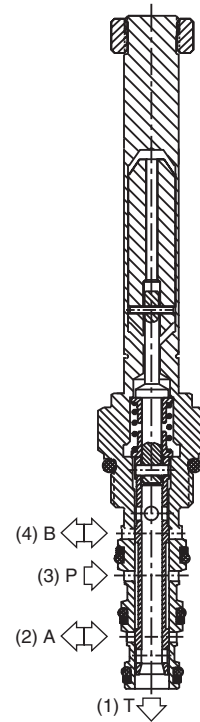
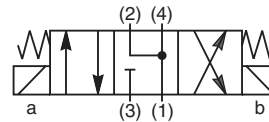

Specifications

Rated Flow (At 70 PSI ΔP)	High Flow/Pressure ('SP' Coil) 15 LPM (4.0 GPM)
Maximum Inlet Pressure	'SP' Coil 350 Bar (5000 PSI)
Maximum Tank Pressure	210 Bar (3000 PSI)
Cartridge Material	All parts steel. All operating parts hardened steel.
Operating Temp. Range/Seals	-40°C to +93.3°C (Nitrile) (-40°F to +200°F) -31.7°C to +121.1°C (Fluorocarbon) (-25°F to +250°F)
Fluid Compatibility/ Viscosity	Mineral-based or synthetic with lubricating properties at viscosities of 45 to 2000 SSU (6 to 420 cSt)
Filtration	ISO Code 16/13, SAE Class 4 or better
Approx. Weight	.18 kg (.40 lbs.)
Cavity	C08-4 (See BC Section for more details)

Performance Curves

Pressure Drop vs. Flow (Through cartridge only)

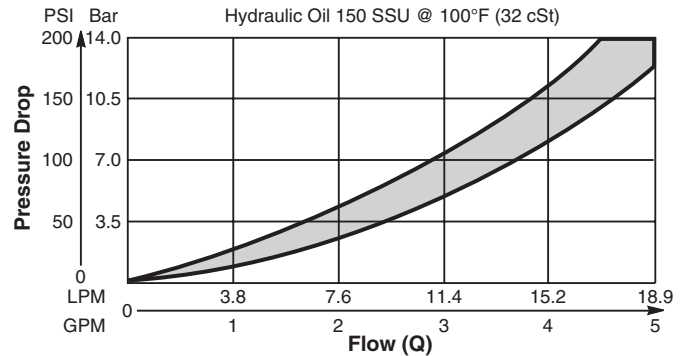

Operating Limits (Measured at 75% of Nominal Current)

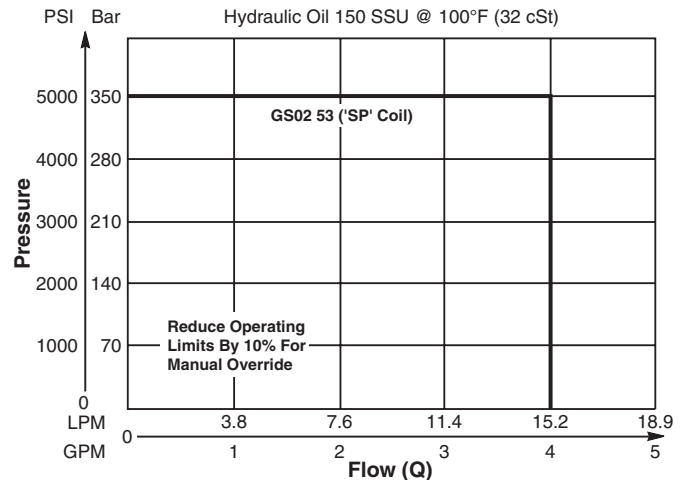

Dimensions Millimeters (Inches)

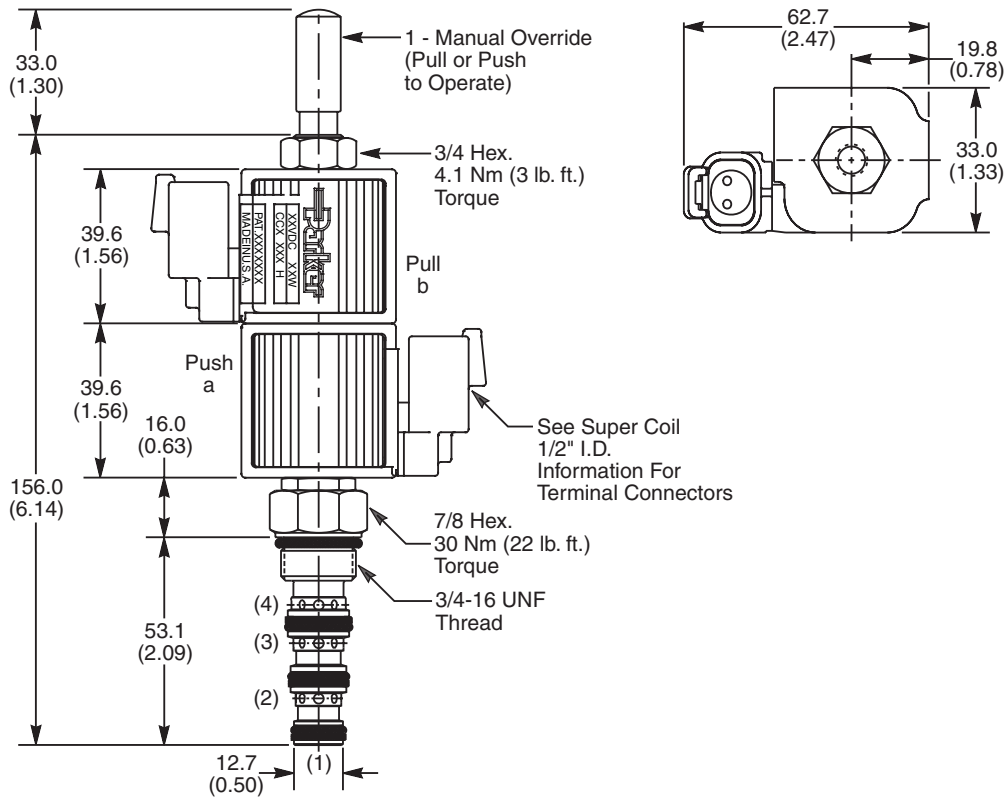

Ordering Information

GS02	53								
08 Size Solenoid Valve	Style	Override Option	Screen	Seals	Coil Type	Coil Voltage	Coil Termination	Body Material	Port Size

Code	Style
53	High Flow and Pressure ('SP' Coil)

Code	Override Options
0	Not Required
1	Manual Override
2	Detented M.O.

Code	Screen
0	Not Available

Code	Seals / Kit No.
N	Nitrile / Buna-N (Std.) (SK30078N-1)
V	Fluorocarbon / (SK30078V-1)

Code	Coil Type
Omit	Without Coil
SP	Super Coil - 19 Watts

Code	Coil Voltage
Omit	Without Coil
D012	12 VDC
D024	24 VDC
A120	120 VAC, 60/50 Hz
A240	240 VAC, 60/50 Hz*

*22 Watts

Code	Coil Termination
Omit	Without Coil
C	Conduit With Leads
D	DIN Plug Face
A	Amp Jr. Timer*
S	Dual Spade*
L	Dual Lead Wire*
SL	Sealed Lead Wire*
H	Molded Deutsch*

See Super Coil 1/2" I.D.
*DC Only

Code	Body Material
Omit	Steel
A	Aluminum

Code	Port Size	Body Part No.
Omit	Cartridge Only	
6T	SAE-6	(B08-4-*6T)
6B	3/8" BSPG	(B08-4-*6B)

* Add "A" for aluminum, omit for steel.

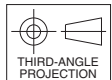

- CV Check Valves
- SH Shuttle Valves
- LM Load/Motor Controls
- FC Flow Controls
- PC Pressure Controls
- LE Logic Elements
- DC Directional Controls
- MV Manual Valves
- SV Solenoid Valves
- PV Proportional Valves
- CE Coils & Electronics
- BC Bodies & Cavities
- TD Technical Data

Technical Information

- CV** Check Valves
- SH** Shuttle Valves
- LM** Load/Motor Controls
- FC** Flow Controls
- PC** Pressure Controls
- LE** Logic Elements
- DC** Directional Controls
- MV** Manual Valves
- SV** Solenoid Valves
- PV** Proportional Valves
- CE** Coils & Electronics
- BC** Bodies & Cavities
- TD** Technical Data

General Description

4-Way, 3 Position, Tandem Center Spool Valve.
For additional information see Technical Tips on pages SV1-SV6.

Features

- Designed to operate double acting cylinders, pilot circuits and bi-directional motors, etc.
- High flow capacity with reduced space requirements
- High pressure capability
- One piece cartridge housing ensures internal concentricity
- Coil: Waterproof, hermetically sealed, requires no O'Rings; Symmetrical coil can be reversed without affecting performance.
- Manual override available

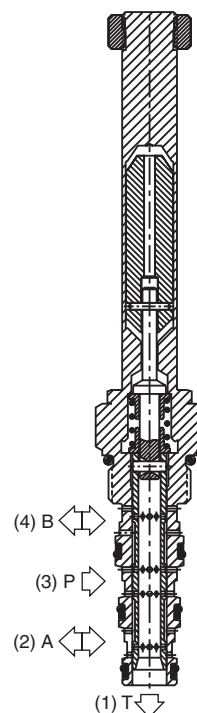
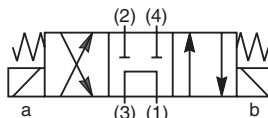

Specifications

Rated Flow (At 70 PSI ΔP)	13.3 LPM (3.5 GPM)
Maximum Inlet Pressure	350 Bar (5000 PSI)
Maximum Tank Pressure	210 Bar (3000 PSI)
Cartridge Material	All parts steel. All operating parts hardened steel.
Operating Temp. Range/Seals	-40°C to +93.3°C (Nitrile) (-40°F to +200°F) -31.7°C to +121.1°C (Fluorocarbon) (-25°F to +250°F)
Fluid Compatibility/ Viscosity	Mineral-based or synthetic with lubricating properties at viscosities of 45 to 2000 SSU (6 to 420 cSt)
Filtration	ISO Code 16/13, SAE Class 4 or better
Approx. Weight	.18 kg (.40 lbs.)
Cavity	C08-4 (See BC Section for more details)

Performance Curves

Pressure Drop vs. Flow (Through cartridge only)

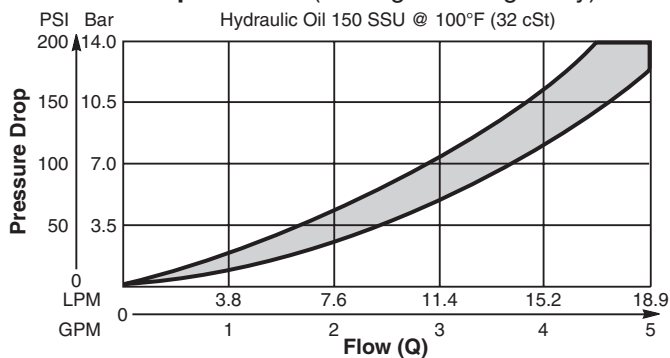

Operating Limits (Measured at 75% of Nominal Current)

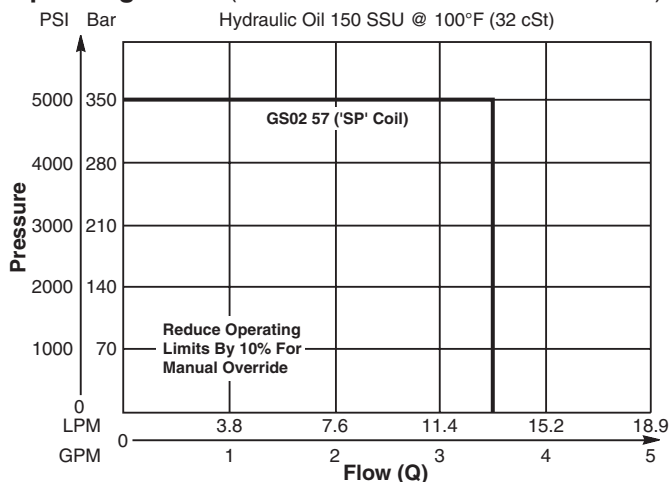

Dimensions Millimeters (Inches)

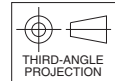
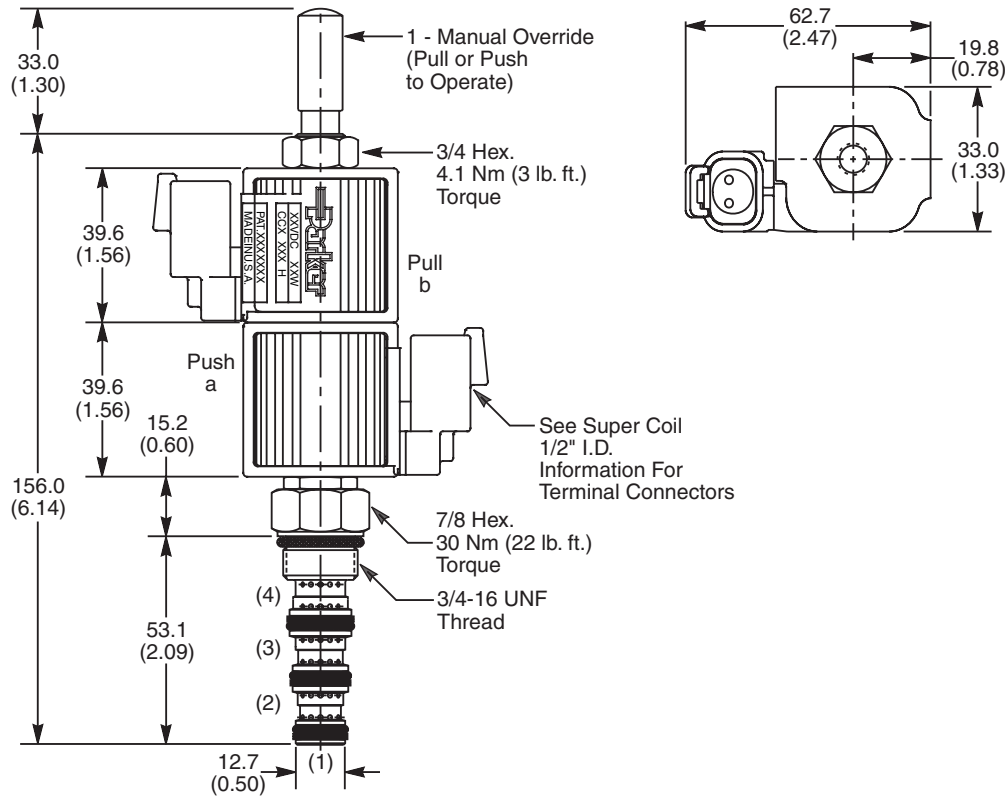

Ordering Information

GS02	57								
08 Size Solenoid Valve	Style	Override Option	Screen	Seals	Coil Type	Coil Voltage	Coil Termination	Body Material	Port Size

Code	Style
57	High Flow ("SP" Coil)

Code	Override Options
0	Not Required
1	Manual Override
2	Detented M.O.

Code	Screen
0	Not Available

Code	Seals / Kit No.
N	Nitrile / Buna-N (Std.) (SK30078N-1)
V	Fluorocarbon / (SK30078V-1)

Code	Coil Type
Omit	Without Coil
SP	Super Coil - 19 Watts

Code	Coil Voltage
Omit	Without Coil
D012	12 VDC
D024	24 VDC
A120	120 VAC, 60/50 Hz
A240	240 VAC, 60/50 Hz*

*22 Watts

Code	Coil Termination
Omit	Without Coil
C	Conduit With Leads
D	DIN Plug Face
A	Amp Jr. Timer*
S	Dual Spade*
L	Dual Lead Wire*
LS	Sealed Lead Wire*
H	Molded Deutsch*

See Super Coil 1/2" I.D.
*DC Only

Code	Body Material
Omit	Steel
A	Aluminum

Code	Port Size	Body Part No.
Omit	Cartridge Only	
6T	SAE-6	(B08-4-*6T)
6B	3/8" BSPG	(B08-4-*6B)

* Add "A" for aluminum, omit for steel.



- CV Check Valves
- SH Shuttle Valves
- LM Load/Motor Controls
- FC Flow Controls
- PC Pressure Controls
- LE Logic Elements
- DC Directional Controls
- MV Manual Valves
- SV Solenoid Valves
- PV Proportional Valves
- CE Coils & Electronics
- BC Bodies & Cavities
- TD Technical Data

Technical Information

- CV** Check Valves
- SH** Shuttle Valves
- LM** Load/Motor Controls
- FC** Flow Controls
- PC** Pressure Controls
- LE** Logic Elements
- DC** Directional Controls
- MV** Manual Valves
- SV** Solenoid Valves
- PV** Proportional Valves
- CE** Coils & Electronics
- BC** Bodies & Cavities
- TD** Technical Data

General Description

4-Way, 3 Position, Open Center Spool Valve.
For additional information see Technical Tips on pages SV1-SV6.

Features

- Designed to operate double acting cylinders, pilot circuits and bi-directional motors, etc.
- High flow capacity with reduced space requirements
- High pressure capability
- One piece cartridge housing ensures internal concentricity
- Coil: Waterproof, hermetically sealed, requires no O'Rings; Symmetrical coil can be reversed without affecting performance.
- Manual override available

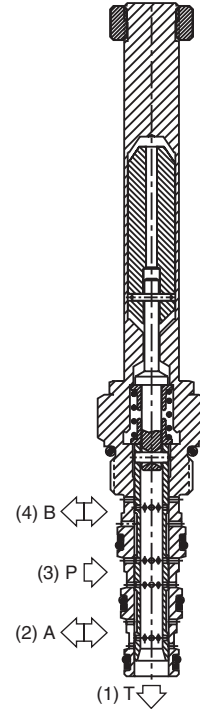
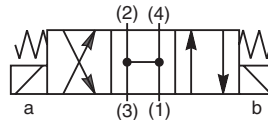

Specifications

Rated Flow (At 70 PSI ΔP)	13.3 LPM (3.5 GPM)
Maximum Inlet Pressure	350 Bar (5000 PSI)
Maximum Tank Pressure	210 Bar (3000 PSI)
Cartridge Material	All parts steel. All operating parts hardened steel.
Operating Temp. Range/Seals	-40°C to +93.3°C (Nitrile) (-40°F to +200°F) -31.7°C to +121.1°C (Fluorocarbon) (-25°F to +250°F)
Fluid Compatibility/Viscosity	Mineral-based or synthetic with lubricating properties at viscosities of 45 to 2000 SSU (6 to 420 cSt)
Filtration	ISO Code 16/13, SAE Class 4 or better
Approx. Weight	.18 kg (.40 lbs.)
Cavity	C08-4 (See BC Section for more details)

Performance Curves

Pressure Drop vs. Flow (Through cartridge only)

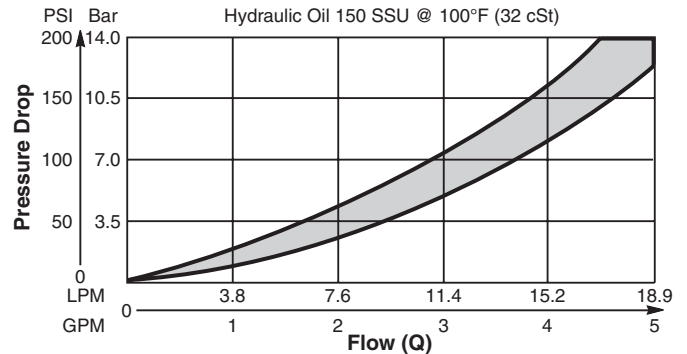

Operating Limits (Measured at 75% of Nominal Current)

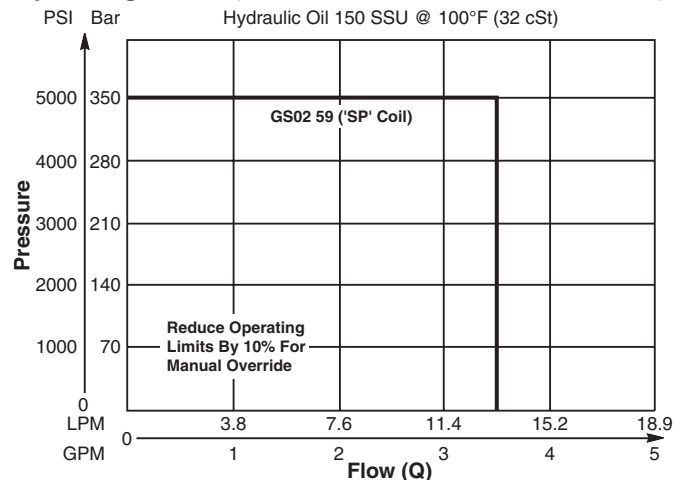

Technical Information

Dimensions Millimeters (Inches)

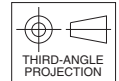
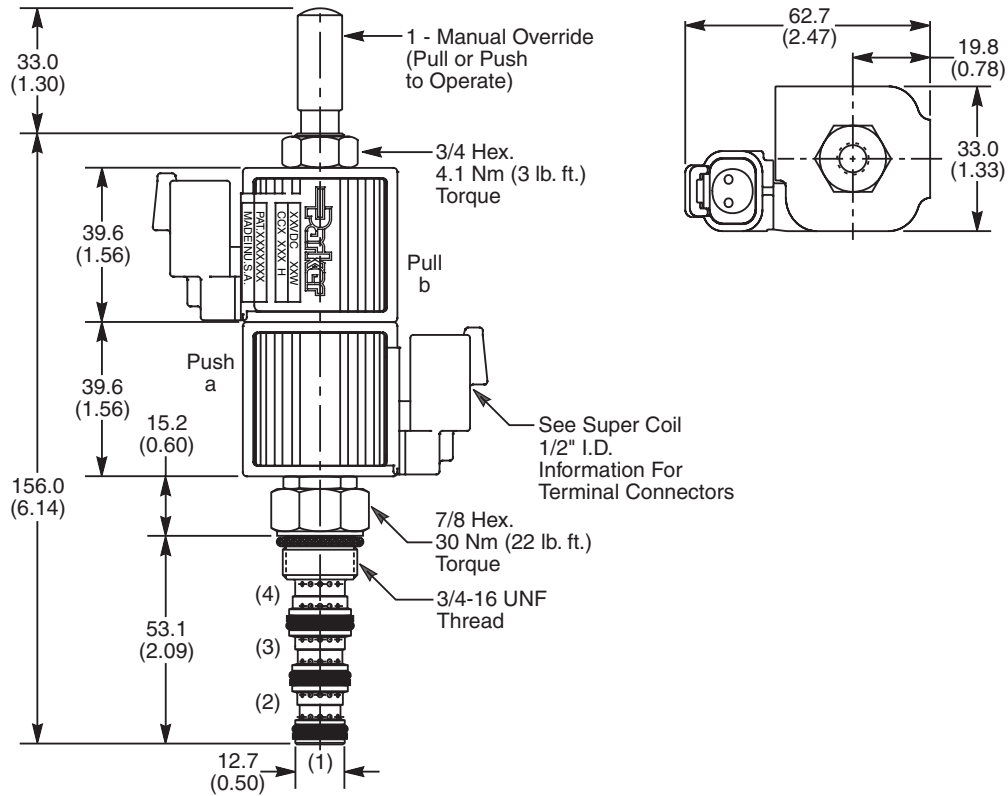

Ordering Information

GS02	59									
08 Size Solenoid Valve	Style	Override Option	Screen	Seals	Coil Type	Coil Voltage	Coil Termination	Body Material	Port Size	

Code	Style
59	High Flow ("SP" Coil)

Code	Override Options
0	Not Required
1	Manual Override
2	Detented M.O.

Code	Screen
0	Not Available

Code	Seals / Kit No.
N	Nitrile / Buna-N (Std.) (SK30078N-1)
V	Fluorocarbon / (SK30078V-1)

Code	Coil Type
Omit	Without Coil
SP	Super Coil - 19 Watts

Code	Coil Voltage
Omit	Without Coil
D012	12 VDC
D024	24 VDC
A120	120 VAC, 60/50 Hz
A240	240 VAC, 60/50 Hz*

*22 Watts

Code	Coil Termination
Omit	Without Coil
C	Conduit With Leads
D	DIN Plug Face
A	Amp Jr. Timer*
S	Dual Spade*
L	Dual Lead Wire*
LS	Sealed Lead Wire*
H	Molded Deutsch*

See Super Coil 1/2" I.D.
*DC Only

Code	Body Material
Omit	Steel
A	Aluminum

Code	Port Size	Body Part No.
Omit	Cartridge Only	
6T	SAE-6	(B08-4-*6T)
6B	3/8" BSPG	(B08-4-*6B)

* Add "A" for aluminum, omit for steel.



- CV Check Valves
- SH Shuttle Valves
- LM Load/Motor Controls
- FC Flow Controls
- PC Pressure Controls
- LE Logic Elements
- DC Directional Controls
- MV Manual Valves
- SV Solenoid Valves
- PV Proportional Valves
- CE Coils & Electronics
- BC Bodies & Cavities
- TD Technical Data

Technical Information

- CV** Check Valves
- SH** Shuttle Valves
- LM** Load/Motor Controls
- FC** Flow Controls
- PC** Pressure Controls
- LE** Logic Elements
- DC** Directional Controls
- MV** Manual Valves
- SV** Solenoid Valves
- PV** Proportional Valves
- CE** Coils & Electronics
- BC** Bodies & Cavities
- TD** Technical Data

General Description

4-Way Spool Valves. For additional information see Technical Tips on pages SV1-SV6.



Features

- High flow capacity with reduced space requirements
- Standard valve bodies and common cavities
- Replaceable, one piece encapsulated coils with minimal amperage draw
- Manual overrides, seal variations and other options available
- Oil immersed armature solenoid, no dynamic seals
- Variety of coil terminations and voltages
- Polyurethane "D"-Ring

Specifications

Rated Flow	C2, C7, C9 18.8 LPM (5 GPM) C1, C4 26.5 LPM (7 GPM)
Maximum Inlet Pressure	250 Bar (3600 PSI)
Leakage at 150 SSU (32 cSt)	160 cc/min. (10 in ³ /min.)
Minimum Operating Voltage	85% of rated voltage at 20°C (72°F).
Response Time	40 - 150 ms
Cartridge Material	All parts steel. All operating parts hardened steel.
Operating Temp. Range/Seals	-45°C to +93.3°C ("D"-Ring) (-50°F to +200°F) -31.7°C to +121.1°C (Fluorocarbon) (-25°F to +250°F)
Fluid Compatibility/ Viscosity	Mineral-based or synthetic with lubricating properties at viscosities of 45 to 2000 SSU (6 to 420 cSt)
Filtration	ISO Code 16/13, SAE Class 4 or better
Approx. Weight	.29 kg (.64 lbs.)
Cavity	C10-4
Form Tool	Rougher NFT10-4R Finisher NFT10-4F



DSL105C1

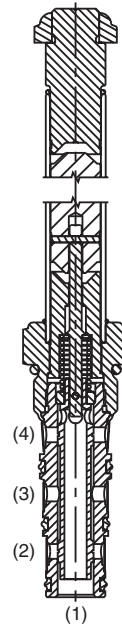
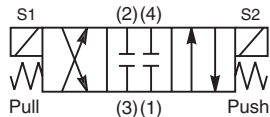

DSL105C1

Performance Curves

Pressure Drop vs. Flow (Through cartridge only)

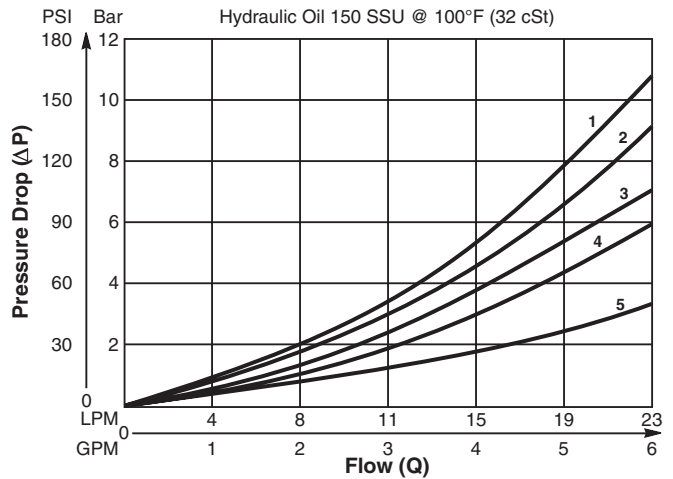

Shift Limit Characteristics (Min. Operating Voltage)

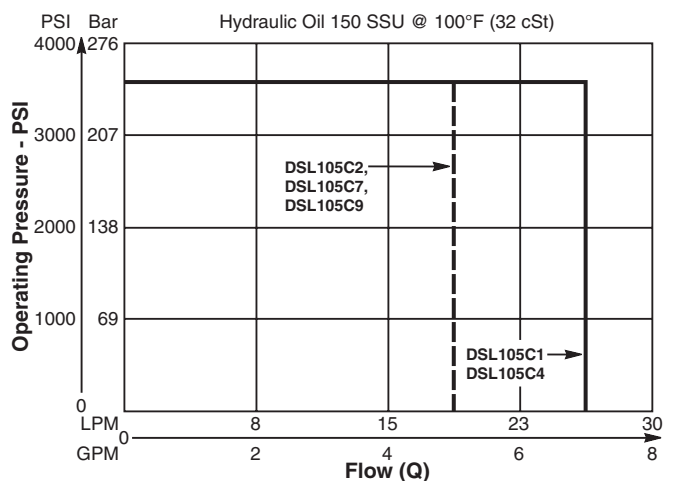

Curve Selection Chart

SPOOL CODE	SPOOL SHIFTED				SPOOL CENTERED		
	3 to 2	3 to 4	2 to 1	4 to 1	3 to 1	2 to 1	4 to 1
C1	2	2	4	4	—	—	—
C2	1	1	2	2	5	4	3
C4	2	2	5	5	—	4	4
C7	1	1	2	2	5	—	3
C9	1	1	2	2	5	—	—



Dimensions Millimeters (Inches)

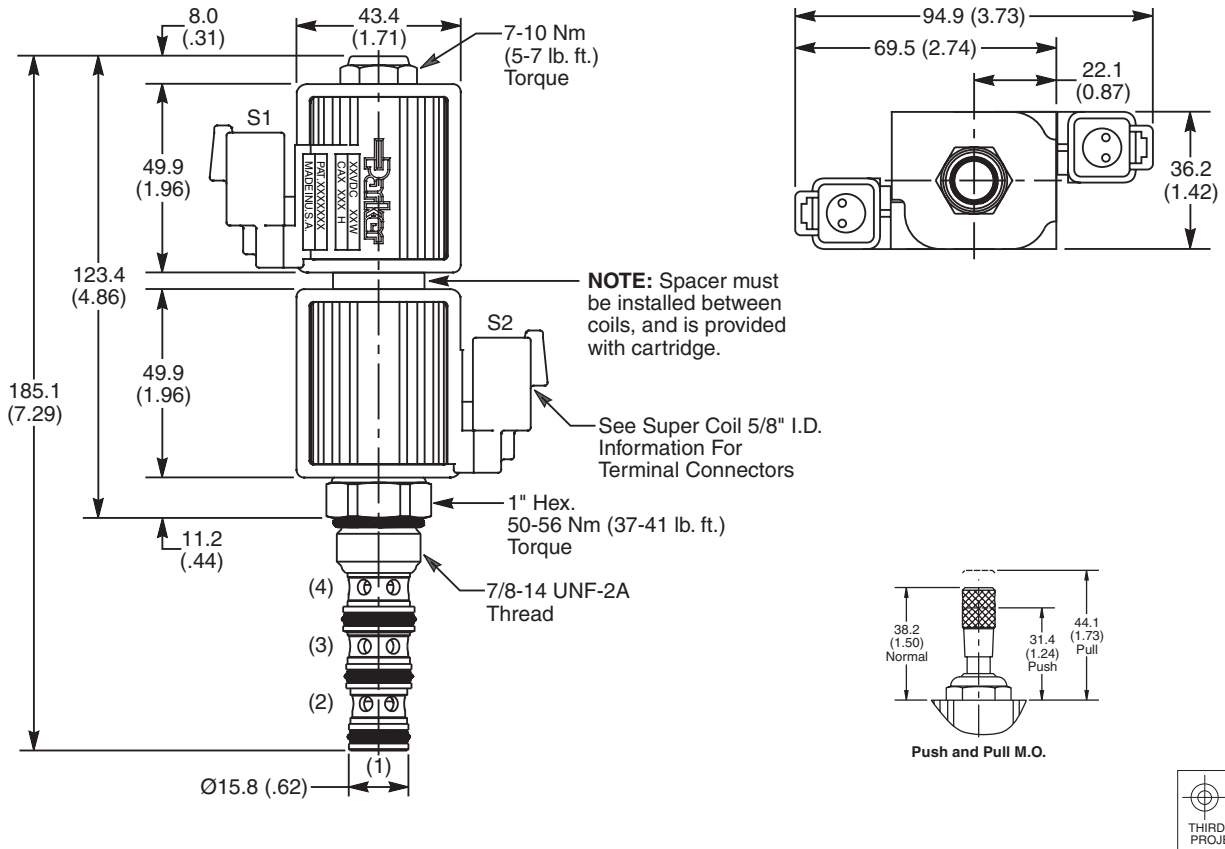

Ordering Information

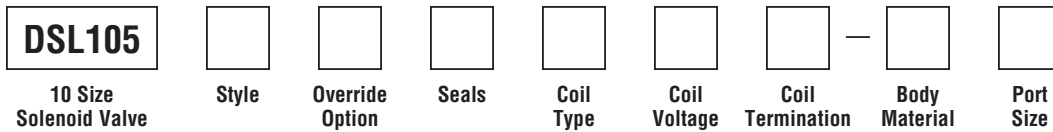

Code	Style
C1	
C2	
C4	
C7	
C9	

Code	Override Options
Omit	None
M	Push/Pull

Code	Seals / Kit. No.
Omit	"D"-Ring / (SK10-4)
N	Nitrile / (SK10-4N)
V	Fluorocarbon / (SK10-4V)

Code	Coil Type
Omit	Without Coil
SP*	Super Coil - 28 Watts

*Recommended

Code	Coil Voltage
Omit	Without Coil
D012	12 VDC
D024	24 VDC
A120	120/110 VAC, 60/50 Hz
A240	240/220 VAC, 60/50 Hz

SP*	Coil Termination
Omit	Without Coil
C	Conduit With Leads
D	DIN Plug Face
A	Amp Jr. Timert
S	Dual Spade†
L	Dual Lead Wire†
LS	Sealed Lead Wire†
H	Molded Deutsch†

*Recommended
 †DC Only

Code	Body Material
Omit	Steel
A	Aluminum

Code	Port Size	Body Part No.
Omit	Cartridge Only	
6P	3/8" NTPF	(B10-4-*6P)
6T	SAE-6	(B10-4-*6T)
8T	SAE-8	(B10-4-*8T)
6B	3/8" BSPG	(B10-4-6B)†

* Add "A" for aluminum, omit for steel.
 † Steel bodies only

Technical Information

- CV** Check Valves
- SH** Shuttle Valves
- LM** Load/Motor Controls
- FC** Flow Controls
- PC** Pressure Controls
- LE** Logic Elements
- DC** Directional Controls
- MV** Manual Valves
- SV** Solenoid Valves
- PV** Proportional Valves
- CE** Coils & Electronics
- BC** Bodies & Cavities
- TD** Technical Data

General Description

4-Way, 3 Position, Closed Center Spool Valve.
For additional information see Technical Tips on pages SV1-SV6.

Features

- Four way closed center valve designed to operate double acting cylinders and bi-directional motors, etc.
- One piece cartridge housing ensures internal concentricity
- Coil: Waterproof, hermetically sealed, requires no O'Rings; Symmetrical coil can be reversed without affecting performance.

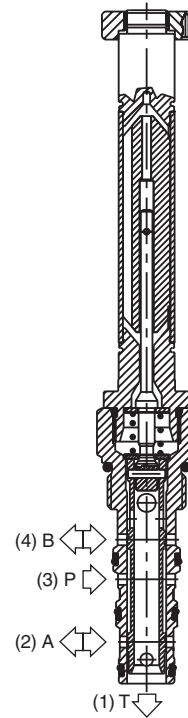
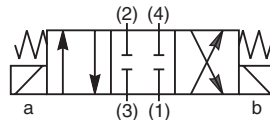

Specifications

Rated Flow (At 70 PSI ΔP)	42 LPM (11 GPM)
Maximum Inlet Pressure	350 Bar (5000 PSI)
Leakage at 150 SSU (32 cSt)	160 cc/min @ 210 Bar (3000 PSI)
Minimum Operating Voltage	85% of rated voltage at 20°C (72°F).
Response Time	Open 30-60 ms Close 20-40 ms
Cartridge Material	All parts steel. All operating parts hardened steel.
Operating Temp. Range/Seals	-40°C to +93.3°C (Nitrile) (-40°F to +200°F) -31.7°C to +121.1°C (Fluorocarbon) (-25°F to +250°F)
Fluid Compatibility/ Viscosity	Mineral-based or synthetic with lubricating properties at viscosities of 45 to 2000 SSU (6 to 420 cSt)
Filtration	ISO Code 16/13, SAE Class 4 or better
Approx. Weight	.26 kg (.58 lbs.)
Cavity	C10-4 (See BC Section for more details)

Performance Curves

Pressure Drop vs. Flow Energized - GS045250ND (Through cartridge only)

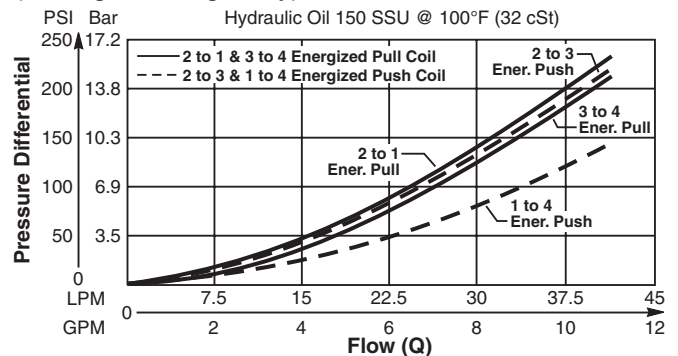

Operating Limits (Measured at 75% of Nominal Current)

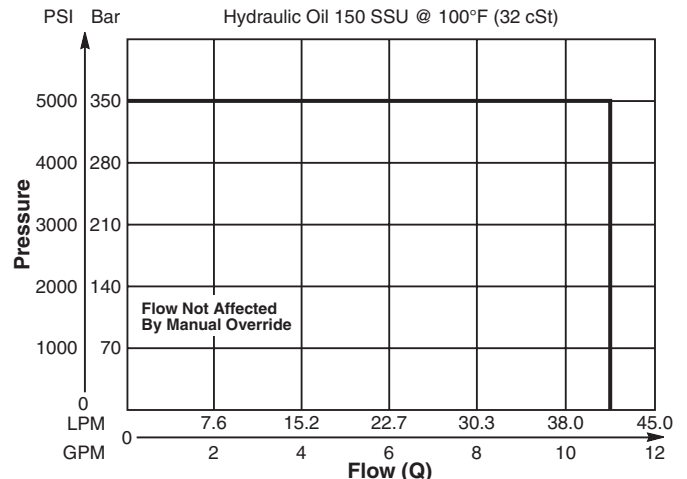

Technical Information

Dimensions Millimeters (Inches)

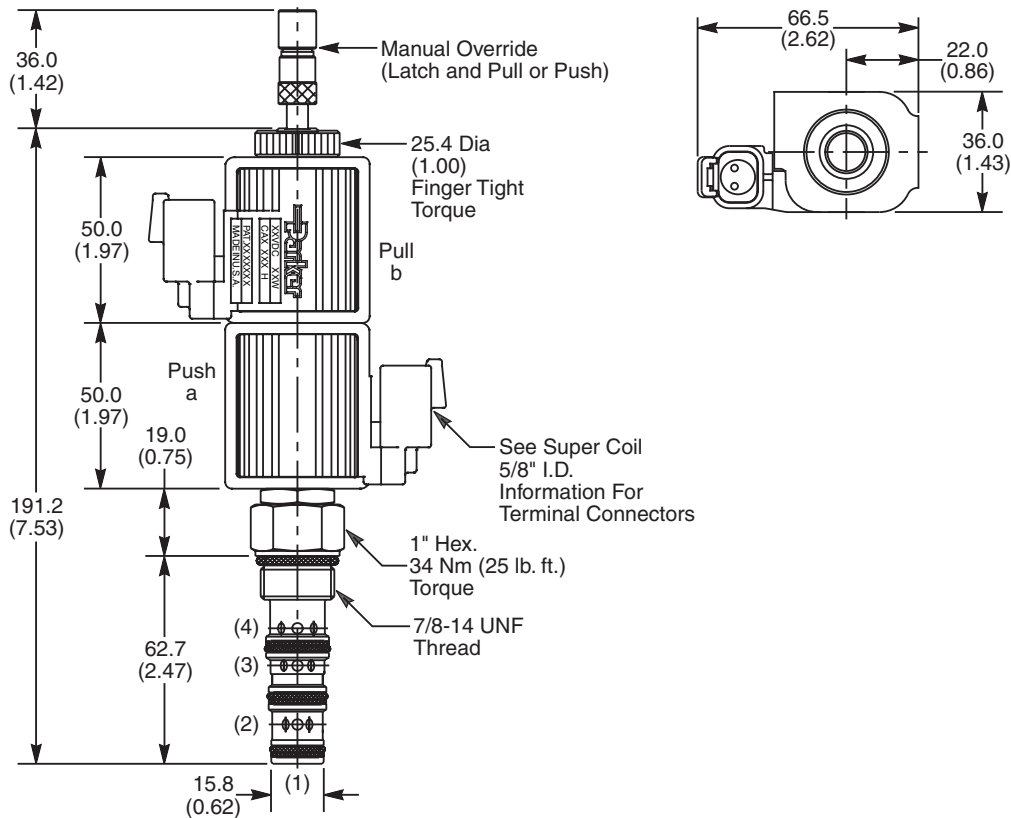

Ordering Information

GS04	52				D					
10 Size Solenoid Valve	Style	Override Option	Screen	Seals	Design Level	Coil Type	Coil Voltage	Coil Termination	Body Material	Port Size

Code	Style
52	High Flow and Pressure ('SP' Coil)

Code	Override Options
0	None
5	Standard - Latch Operated, Pull and Push (*40 nt/9 lbs.)

*Force to push at 210 Bar (3000 PSI). Less to Pull.

Code	Screen
0	None (Contact factory for OEM requirements)

Code	Seals / Kit No.
N	Nitrile / Buna-N (Std.) (SK30506N-1)
V	Fluorocarbon / (SK30506V-1)

Code	Design Level
D	Includes Industry Common Cavity

Code	Coil Type
Omit	Without Coil
SP	Super Coil - 28 Watts

Code	Coil Voltage
Omit	Without Coil
D012	12 VDC
D024	24 VDC
A120	120 VAC, 60/50 Hz
A240	240 VAC, 60/50 Hz*

*22 Watts

Code	Coil Termination
Omit	Without Coil
C	Conduit With Leads
D	DIN Plug Face
A	Amp Jr. Timer*
S	Dual Spade*
L	Dual Lead Wire*
LS	Sealed Lead Wire*
H	Molded Deutsch*

See Super Coil 5/8" I.D.
*DC Only

Code	Body Material
Omit	Steel
A	Aluminum

Code	Port Size	Body Part No.
Omit		Cartridge Only
8T	SAE-8	(B10-4-*8T)
8B	1/2" BSPG	(B10-4-*8B)

* Add "A" for aluminum, omit for steel.



- CV Check Valves
- SH Shuttle Valves
- LM Load/Motor Controls
- FC Flow Controls
- PC Pressure Controls
- LE Logic Elements
- DC Directional Controls
- MV Manual Valves
- SV Solenoid Valves
- PV Proportional Valves
- CE Coils & Electronics
- BC Bodies & Cavities
- TD Technical Data

Technical Information

- CV** Check Valves
- SH** Shuttle Valves
- LM** Load/Motor Controls
- FC** Flow Controls
- PC** Pressure Controls
- LE** Logic Elements
- DC** Directional Controls
- MV** Manual Valves
- SV** Solenoid Valves
- PV** Proportional Valves
- CE** Coils & Electronics
- BC** Bodies & Cavities
- TD** Technical Data

General Description

4-Way, 3 Position, Floating Center Spool Valve.
For additional information see Technical Tips on pages SV1-SV6.

Features

- Four way floating center valve designed to operate double acting cylinders and bi-directional motors, etc.
- One piece cartridge housing ensures internal concentricity
- Coil: Waterproof, hermetically sealed, requires no O'Rings; Symmetrical coil can be reversed without affecting performance.

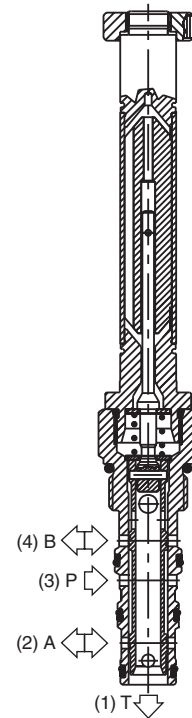
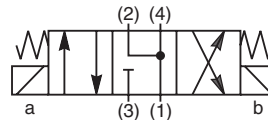

Specifications

Rated Flow (At 70 PSI ΔP)	42 LPM (11 GPM)
Maximum Inlet Pressure	350 Bar (5000 PSI)
Leakage at 150 SSU (32 cSt)	160 cc/min @ 210 Bar (3000 PSI)
Minimum Operating Voltage	85% of rated voltage at 20°C (72°F).
Response Time	Open 30-60 ms Close 20-40 ms
Cartridge Material	All parts steel. All operating parts hardened steel.
Operating Temp. Range/Seals	-40°C to +93.3°C (Nitrile) (-40°F to +200°F) -31.7°C to +121.1°C (Fluorocarbon) (-25°F to +250°F)
Fluid Compatibility/ Viscosity	Mineral-based or synthetic with lubricating properties at viscosities of 45 to 2000 SSU (6 to 420 cSt)
Filtration	ISO Code 16/13, SAE Class 4 or better
Approx. Weight	.26 kg (.58 lbs.)
Cavity	C10-4 (See BC Section for more details)

Performance Curves

Pressure Drop vs. Flow Energized - GS045450ND
(Through cartridge only)

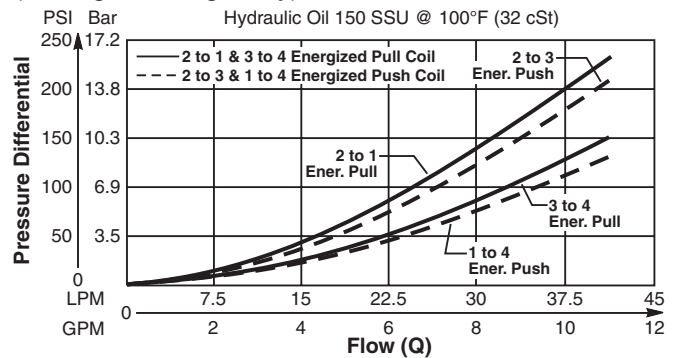

Operating Limits (Measured at 75% of Nominal Current)

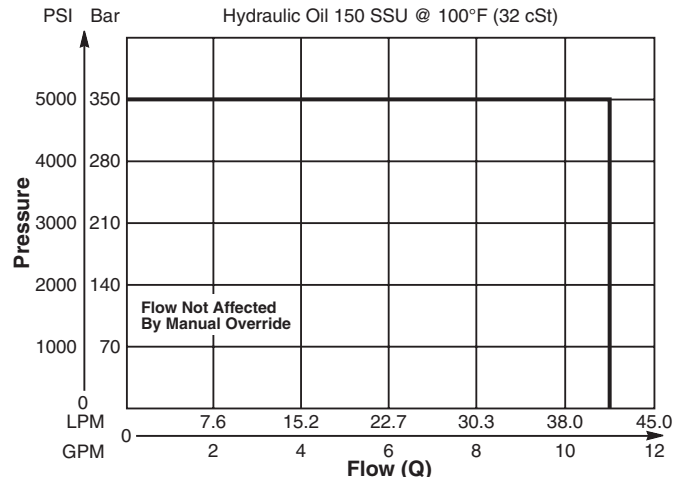

Technical Information

Dimensions Millimeters (Inches)

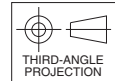
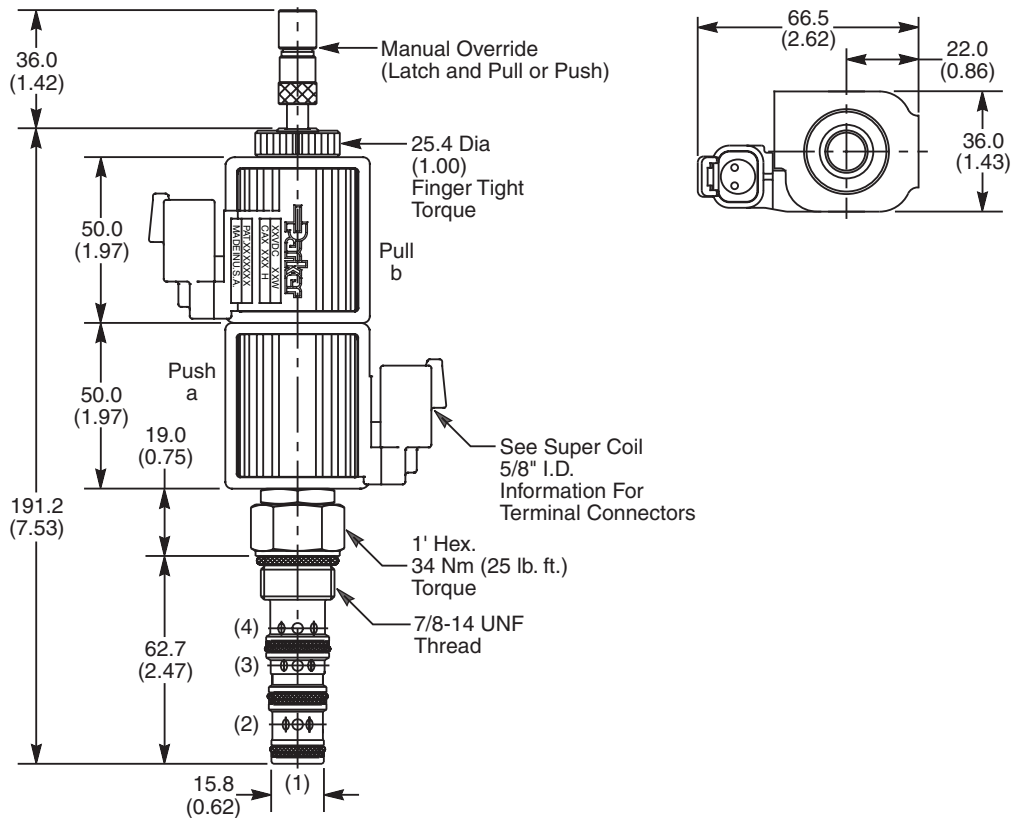

Ordering Information

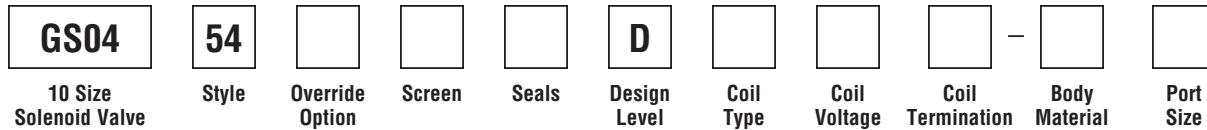

Code	Style
54	High Flow and Pressure ('SP' Coil)

Code	Seals / Kit No.
N	Nitrile / Buna-N (Std.) (SK30506N-1)
V	Fluorocarbon / (SK30506V-1)

Code	Coil Termination
Omit	Without Coil
C	Conduit With Leads
D	DIN Plug Face
A	Amp Jr. Timer*
S	Dual Spade*
L	Dual Lead Wire*
LS	Sealed Lead Wire*
H	Molded Deutsch*

Code	Body Material
Omit	Steel
A	Aluminum

Code	Override Options
0	None
5	Standard - Latch Operated, Pull and Push (*40 nt/9 lbs.)

Code	Design Level
D	Includes Industry Common Cavity

Code	Port Size	Body Part No.
Omit	Cartridge Only	
8T	SAE-8	(B10-4-*8T)
8B	1/2" BSPG	(B10-4-*8B)

*Force to push at 210 Bar (3000 PSI). Less to Pull.

Code	Screen
0	None (Contact factory for OEM requirements)

Code	Coil Type
Omit	Without Coil
SP	Super Coil - 28 Watts

See Super Coil 5/8" I.D.
*DC Only

Code	Coil Voltage
Omit	Without Coil
D012	12 VDC
D024	24 VDC
A120	120 VAC, 60/50 Hz
A240	240 VAC, 60/50 Hz*

*22 Watts

* Add "A" for aluminum, omit for steel.



- CV Check Valves
- SH Shuttle Valves
- LM Load/Motor Controls
- FC Flow Controls
- PC Pressure Controls
- LE Logic Elements
- DC Directional Controls
- MV Manual Valves
- SV Solenoid Valves
- PV Proportional Valves
- CE Coils & Electronics
- BC Bodies & Cavities
- TD Technical Data

Technical Information

- CV** Check Valves
- SH** Shuttle Valves
- LM** Load/Motor Controls
- FC** Flow Controls
- PC** Pressure Controls
- LE** Logic Elements
- DC** Directional Controls
- MV** Manual Valves
- SV** Solenoid Valves
- PV** Proportional Valves
- CE** Coils & Electronics
- BC** Bodies & Cavities
- TD** Technical Data

General Description

4-Way, 3 Position, Tandem Center Spool Valve.
For additional information see Technical Tips on pages SV1-SV6.

Features

- Four way tandem center valve designed to operate double acting cylinders and bi-directional motors, etc.
- One piece cartridge housing ensures internal concentricity
- Coil: Waterproof, hermetically sealed, requires no O'Rings; Symmetrical coil can be reversed without affecting performance.

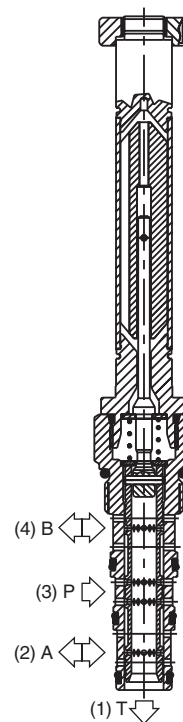
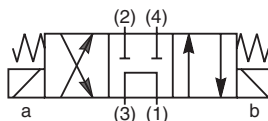

Specifications

Rated Flow (At 70 PSI ΔP)	42 LPM (11 GPM)
Maximum Inlet Pressure	350 Bar (5000 PSI)
Leakage at 150 SSU (32 cSt)	160 cc/min @ 210 Bar (3000 PSI)
Minimum Operating Voltage	85% of rated voltage at 20°C (72°F).
Response Time	Open 30-60 ms Close 20-40 ms
Cartridge Material	All parts steel. All operating parts hardened steel.
Operating Temp. Range/Seals	-40°C to +93.3°C (Nitrile) (-40°F to +200°F) -31.7°C to +121.1°C (Fluorocarbon) (-25°F to +250°F)
Fluid Compatibility/ Viscosity	Mineral-based or synthetic with lubricating properties at viscosities of 45 to 2000 SSU (6 to 420 cSt)
Filtration	ISO Code 16/13, SAE Class 4 or better
Approx. Weight	.26 kg (.58 lbs.)
Cavity	C10-4 (See BC Section for more details)

Performance Curves

Pressure Drop vs. Flow (Through cartridge only)

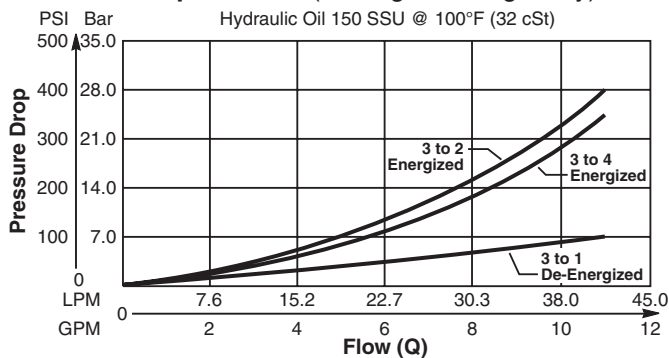

Operating Limits (Measured at 75% of Nominal Current)

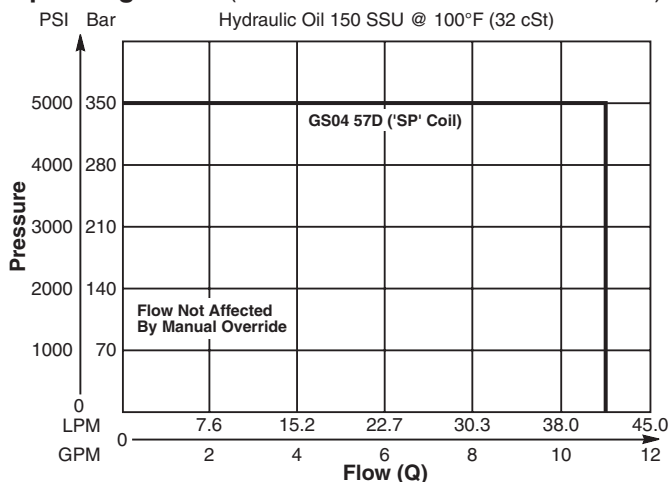

Dimensions Millimeters (Inches)

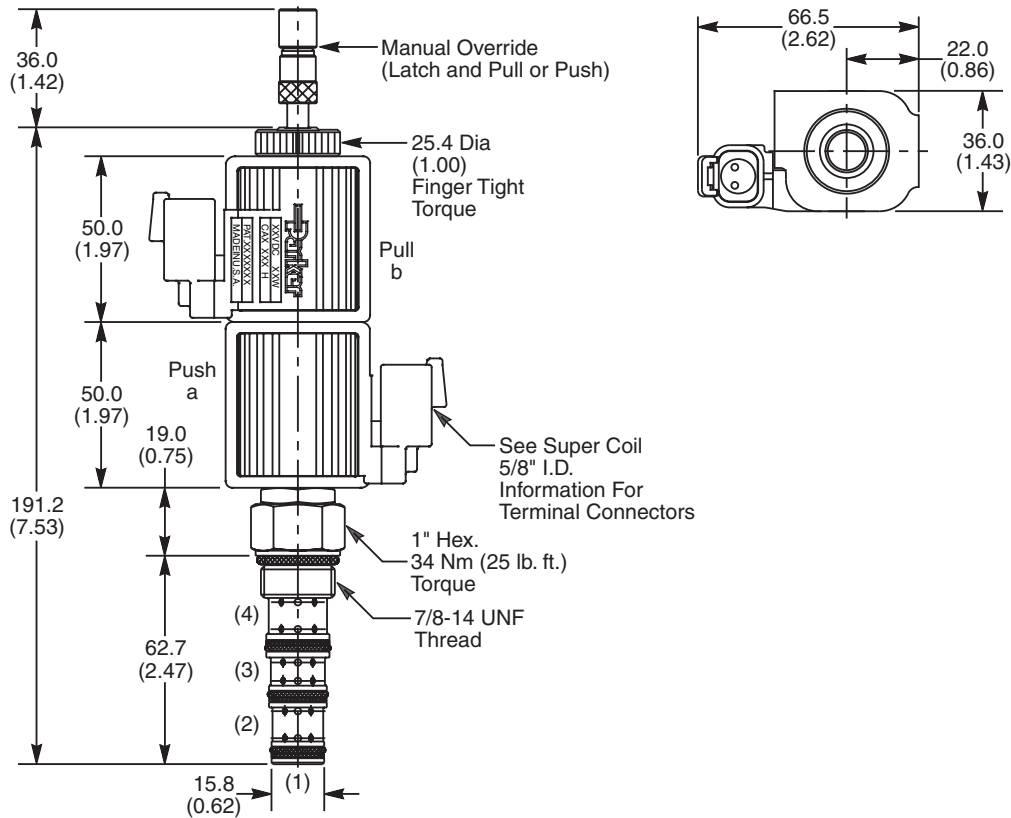

Ordering Information

GS04	57				D					
10 Size Solenoid Valve	Style	Override Option	Screen	Seals	Design Level	Coil Type	Coil Voltage	Coil Termination	Body Material	Port Size

Code	Style
57	High Flow and Pressure ('SP' Coil)

Code	Override Options
0	None
5	Standard - Latch Operated, Pull and Push (*40 nt/9 lbs.)

*Force to push at 210 Bar (3000 PSI). Less to Pull.

Code	Screen
0	None (Contact factory for OEM requirements)

Code	Seals / Kit No.
N	Nitrile / Buna-N (Std.) (SK30506N-1)
V	Fluorocarbon / (SK30506V-1)

Code	Design Level
D	Includes Industry Common Cavity

Code	Coil Type
Omit	Without Coil
SP	Super Coil - 28 Watts

Code	Coil Voltage
Omit	Without Coil
D012	12 VDC
D024	24 VDC
A120	120 VAC, 60/50 Hz
A240	240 VAC, 60/50 Hz*

*22 Watts

Code	Coil Termination
Omit	Without Coil
C	Conduit With Leads
D	DIN Plug Face
A	Amp Jr. Timer*
S	Dual Spade*
L	Dual Lead Wire*
LS	Sealed Lead Wire*
H	Molded Deutsch*

See Super Coil 5/8" I.D.
*DC Only

Code	Body Material
Omit	Steel
A	Aluminum

Code	Port Size	Body Part No.
Omit	Cartridge Only	
8T	SAE-8	(B10-4-*8T)
8B	1/2" BSPG	(B10-4-*8B)

* Add "A" for aluminum, omit for steel.

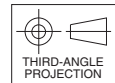

- CV**
- Check Valves
- SH**
- Shuttle Valves
- LM**
- Load/Motor Controls
- FC**
- Flow Controls
- PC**
- Pressure Controls
- LE**
- Logic Elements
- DC**
- Directional Controls
- MV**
- Manual Valves
- SV**
- Solenoid Valves
- PV**
- Proportional Valves
- CE**
- Coils & Electronics
- BC**
- Bodies & Cavities
- TD**
- Technical Data

Technical Information

- CV** Check Valves
- SH** Shuttle Valves
- LM** Load/Motor Controls
- FC** Flow Controls
- PC** Pressure Controls
- LE** Logic Elements
- DC** Directional Controls
- MV** Manual Valves
- SV** Solenoid Valves
- PV** Proportional Valves
- CE** Coils & Electronics
- BC** Bodies & Cavities
- TD** Technical Data

General Description

4-Way, 3 Position, Open Center Spool Valve.
For additional information see Technical Tips on pages SV1-SV6.

Features

- Four way open center valve designed to operate double acting cylinders and bi-directional motors, etc.
- One piece cartridge housing ensures internal concentricity
- Coil: Waterproof, hermetically sealed, requires no O’Rings; Symmetrical coil can be reversed without affecting performance.

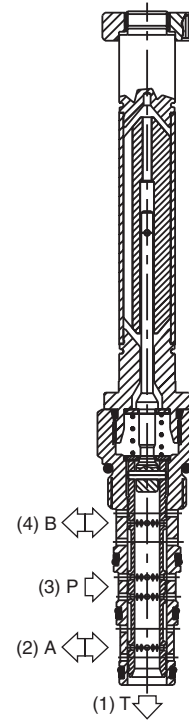
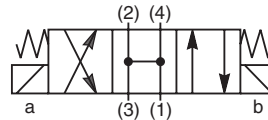

Specifications

Rated Flow (At 70 PSI ΔP)	42 LPM (11 GPM)
Maximum Inlet Pressure	350 Bar (5000 PSI)
Leakage at 150 SSU (32 cSt)	160 cc/min @ 210 Bar (3000 PSI)
Minimum Operating Voltage	85% of rated voltage at 20°C (72°F).
Response Time	Open 30-60 ms Close 20-40 ms
Cartridge Material	All parts steel. All operating parts hardened steel.
Operating Temp. Range/Seals	-40°C to +93.3°C (Nitrile) (-40°F to +200°F) -31.7°C to +121.1°C (Fluorocarbon) (-25°F to +250°F)
Fluid Compatibility/ Viscosity	Mineral-based or synthetic with lubricating properties at viscosities of 45 to 2000 SSU (6 to 420 cSt)
Filtration	ISO Code 16/13, SAE Class 4 or better
Approx. Weight	.26 kg (.58 lbs.)
Cavity	C10-4 (See BC Section for more details)

Performance Curves

Pressure Drop vs. Flow (Through cartridge only)

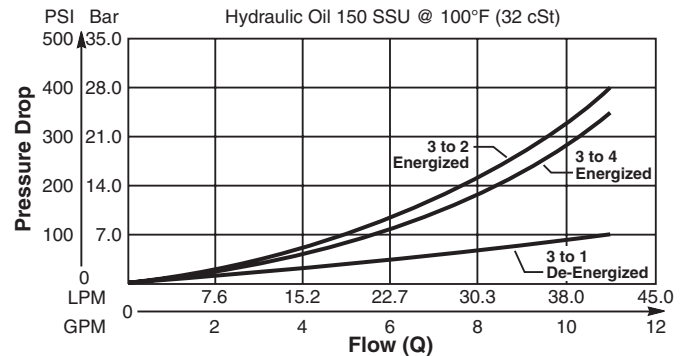

Operating Limits (Measured at 75% of Nominal Current)

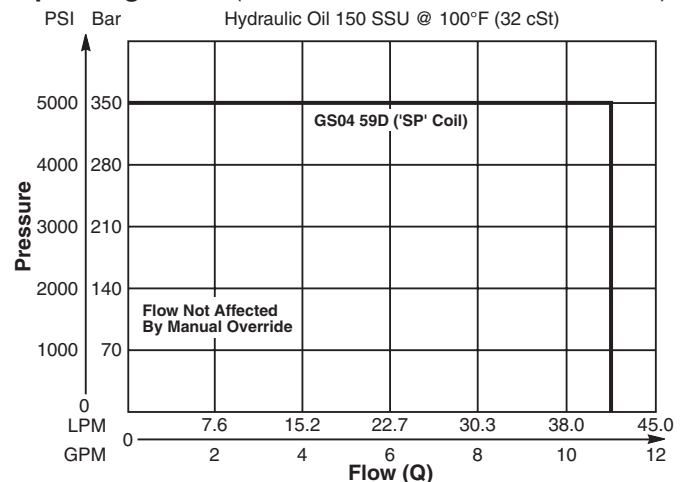

Technical Information

Dimensions Millimeters (Inches)

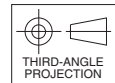
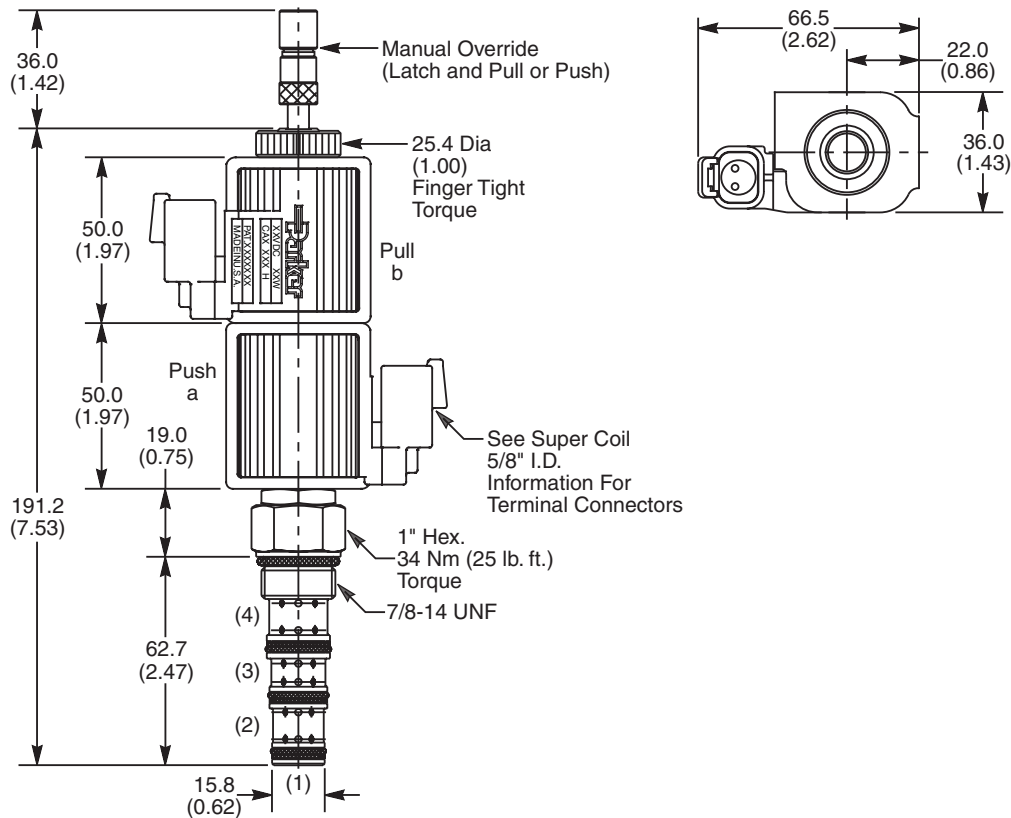

Ordering Information

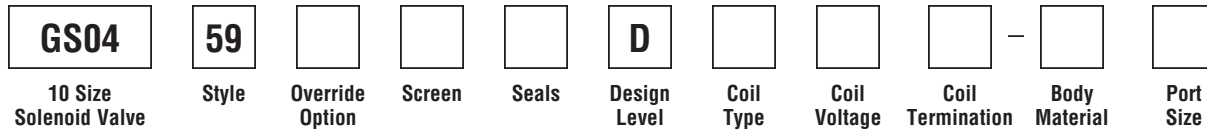

Code	Style
59	High Flow and Pressure ('SP' Coil)

Code	Override Options
0	None
5	Standard - Latch Operated, Pull and Push (*40 nt/9 lbs.)

*Force to push at 210 Bar (3000 PSI). Less to Pull.

Code	Screen
0	None (Contact factory for OEM requirements)

Code	Seals / Kit No.
N	Nitrile / Buna-N (Std.) (SK30506N-1)
V	Fluorocarbon / (SK30506V-1)

Code	Design Level
D	Includes Industry Common Cavity

Code	Coil Type
Omit	Without Coil
SP	Super Coil - 28 Watts

Code	Coil Voltage
Omit	Without Coil
D012	12 VDC
D024	24 VDC
A120	120 VAC, 60/50 Hz
A240	240 VAC, 60/50 Hz*

*22 Watts

Code	Coil Termination
Omit	Without Coil
C	Conduit With Leads
D	DIN Plug Face
A	Amp Jr. Timer*
S	Dual Spade*
L	Dual Lead Wire*
LS	Sealed Lead Wire*
H	Molded Deutsch*

See Super Coil 5/8" I.D.
*DC Only

Code	Body Material
Omit	Steel
A	Aluminum

Code	Port Size	Body Part No.
Omit	Cartridge Only	
8T	SAE-8	(B10-4-*8T)
8B	1/2" BSPG	(B10-4-*8B)

* Add "A" for aluminum, omit for steel.



- CV Check Valves
- SH Shuttle Valves
- LM Load/Motor Controls
- FC Flow Controls
- PC Pressure Controls
- LE Logic Elements
- DC Directional Controls
- MV Manual Valves
- SV Solenoid Valves
- PV Proportional Valves
- CE Coils & Electronics
- BC Bodies & Cavities
- TD Technical Data

Technical Information

- CV** Check Valves
- SH** Shuttle Valves
- LM** Load/Motor Controls
- FC** Flow Controls
- PC** Pressure Controls
- LE** Logic Elements
- DC** Directional Controls
- MV** Manual Valves
- SV** Solenoid Valves
- PV** Proportional Valves
- CE** Coils & Electronics
- BC** Bodies & Cavities
- TD** Technical Data

General Description

4-Way, 3 Position, Closed Center Spool Valve.
For additional information see Technical Tips on pages SV1-SV6.

Features

- Four way closed center valve designed to operate double acting cylinders and bi-directional motors, etc.
- One piece cartridge housing ensures internal concentricity
- Coil: Waterproof, hermetically sealed, requires no O'Rings; Symmetrical coil can be reversed without affecting performance.
- All external parts zinc plated

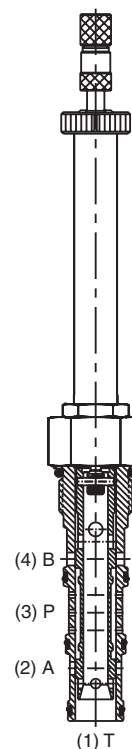
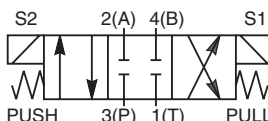
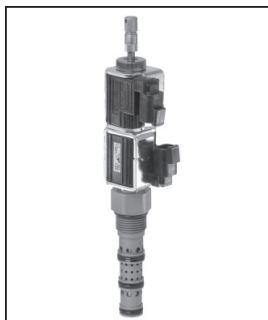

Specifications

Rated Flow (At 70 PSI ΔP)	57 LPM (15 GPM)	
Maximum Inlet Pressure	350 Bar (5000 PSI)	
Leakage at 150 SSU (32 cSt)	160 cc/min @ 210 Bar (3000 PSI)	
Minimum Operating Voltage	75% of rated voltage at 20°C (72°F).	
Response Time	Energized	30-60 ms
	De-Energized	20-40 ms
Cartridge Material	All parts steel. All operating parts hardened steel.	
Operating Temp. Range/Seals	-45°C to +93.3°C (Nitrile) (-50°F to +200°F) -31.7°C to +121.1°C (Fluorocarbon) (-25°F to +250°F)	
Fluid Compatibility/ Viscosity	Mineral-based or synthetic with lubricating properties at viscosities of 45 to 2000 SSU (6 to 420 cSt)	
Filtration	ISO Code 16/13, SAE Class 4 or better	
Approx. Weight	.45 kg (1.0 lbs.)	
Cavity	C12-4L (See BC Section for more details)	

Performance Curves

Pressure Drop vs. Flow
(Through cartridge only)

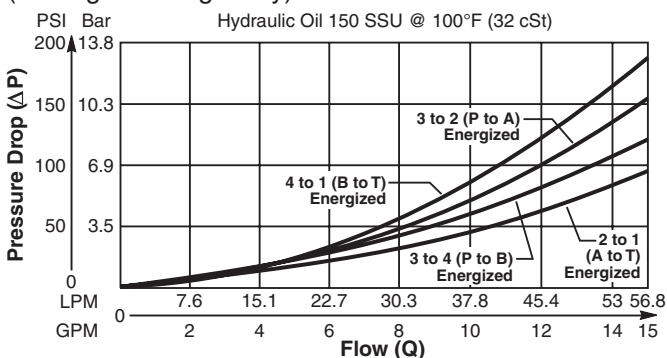

Shift Limit Characteristics (Min. Operating Voltage)

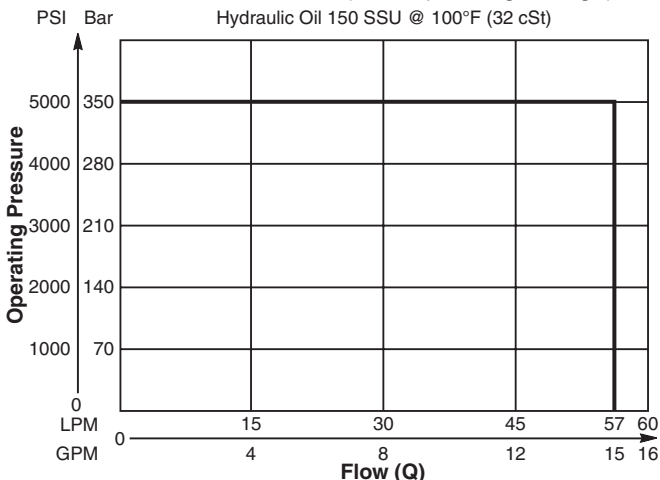

Technical Information

Dimensions Millimeters (Inches)

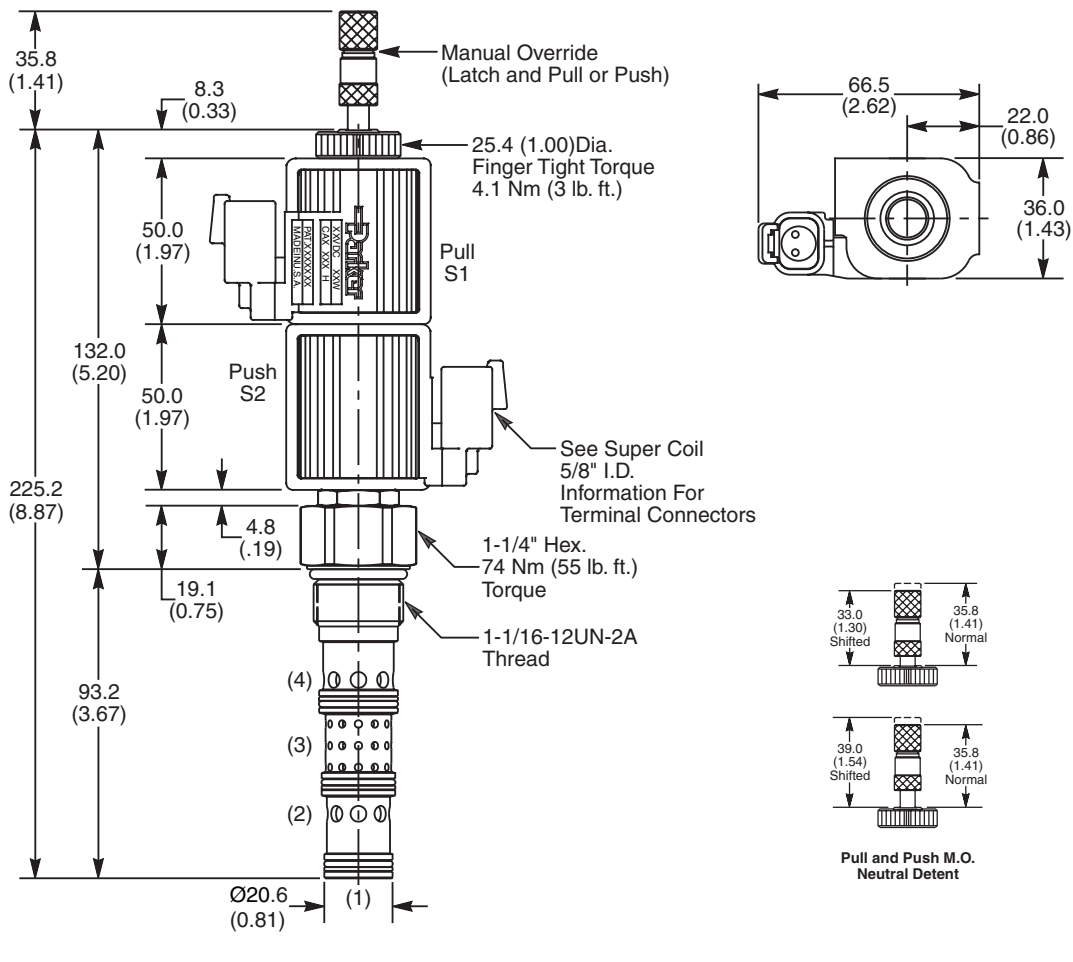

Ordering Information

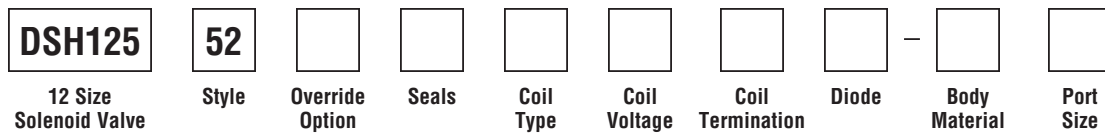

Code	Style
52	High Flow ('SP' Coil)

Code	Coil Type
Omit	Without Coil
SP	Super Coil - 28 Watts

Code	Coil Termination
Omit	Without Coil
C	Conduit With Leads
D	DIN Plug Face
S	Dual Spade*
L	Dual Lead Wire*
LS	Sealed Lead Wire*
H	Molded Deutsch*

Code	Body Material
Omit	Steel
A	Aluminum

Code	Override Options
Omit	None (Consult Factory)
DN	Latch Operated**

Code	Coil Voltage
Omit	Without Coil
D012	12 VDC
D024	24 VDC
A120	120 VAC, 60/50 Hz
A240	240 VAC, 60/50 Hz*

See Super Coil 5/8" I.D.
*DC Only

Code	Port Size	Body Part No.
Omit	Cartridge Only	
12T	SAE-12	(B12-4L-*12T)

* Add "A" for aluminum, omit for steel.

Code	Seals / Kit No.
N	Nitrile / Buna-N (Std.) (SK12-4LN)
V	Fluorocarbon / (SK12-4LV)

**22 Watts

Code	Diode
Omit	None
R	Diode



- CV
Check Valves
- SH
Shuttle Valves
- LM
Load/Motor Controls
- FC
Flow Controls
- PC
Pressure Controls
- LE
Logic Elements
- DC
Directional Controls
- MV
Manual Valves
- SV
Solenoid Valves
- PV
Proportional Valves
- CE
Coils & Electronics
- BC
Bodies & Cavities
- TD
Technical Data

Technical Information

- CV** Check Valves
- SH** Shuttle Valves
- LM** Load/Motor Controls
- FC** Flow Controls
- PC** Pressure Controls
- LE** Logic Elements
- DC** Directional Controls
- MV** Manual Valves
- SV** Solenoid Valves
- PV** Proportional Valves
- CE** Coils & Electronics
- BC** Bodies & Cavities
- TD** Technical Data

General Description

4-Way, 3 Position, Floating Center Spool Valve.
For additional information see Technical Tips on pages SV1-SV6.

Features

- Four way floating center valve designed to operate double acting cylinders and bi-directional motors, etc.
- One piece cartridge housing ensures internal concentricity
- Coil: Waterproof, hermetically sealed, requires no O’Rings; Symmetrical coil can be reversed without affecting performance.
- All external parts zinc plated

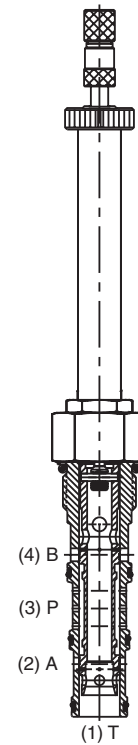
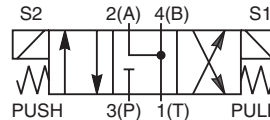
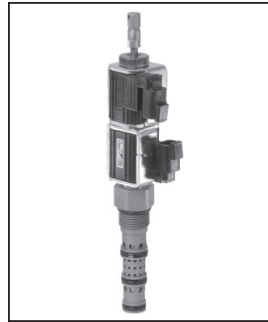

Specifications

Rated Flow (At 70 PSI ΔP)	57 LPM (15 GPM)	
Maximum Inlet Pressure	350 Bar (5000 PSI)	
Leakage at 150 SSU (32 cSt)	160 cc/min @ 210 Bar (3000 PSI)	
Minimum Operating Voltage	75% of rated voltage at 20°C (72°F).	
Response Time	Energized	30-60 ms
	De-Energized	20-40 ms
Cartridge Material	All parts steel. All operating parts hardened steel.	
Operating Temp. Range/Seals	-45°C to +93.3°C (Nitrile) (-50°F to +200°F) -31.7°C to +121.1°C (Fluorocarbon) (-25°F to +250°F)	
Fluid Compatibility/ Viscosity	Mineral-based or synthetic with lubricating properties at viscosities of 45 to 2000 SSU (6 to 420 cSt)	
Filtration	ISO Code 16/13, SAE Class 4 or better	
Approx. Weight	.45 kg (1.0 lbs.)	
Cavity	C12-4L (See BC Section for more details)	

Performance Curves
Pressure Drop vs. Flow
(Through cartridge only)

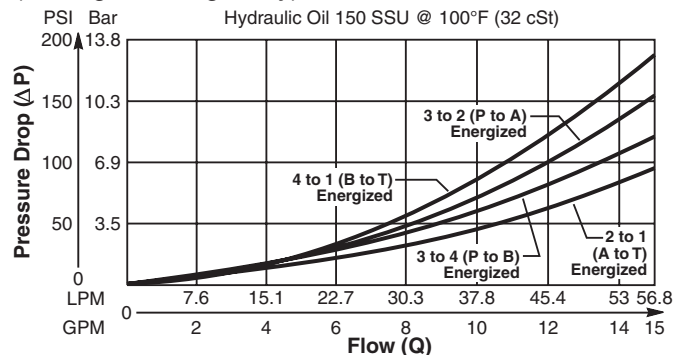

Shift Limit Characteristics (Min. Operating Voltage)

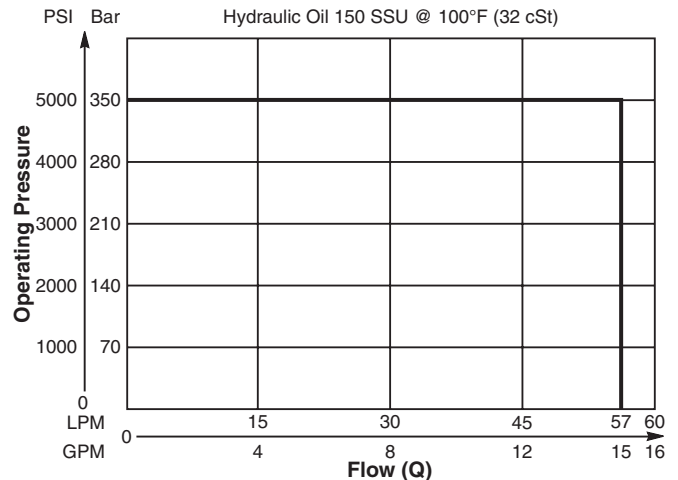

Technical Information

Dimensions Millimeters (Inches)

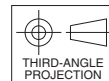
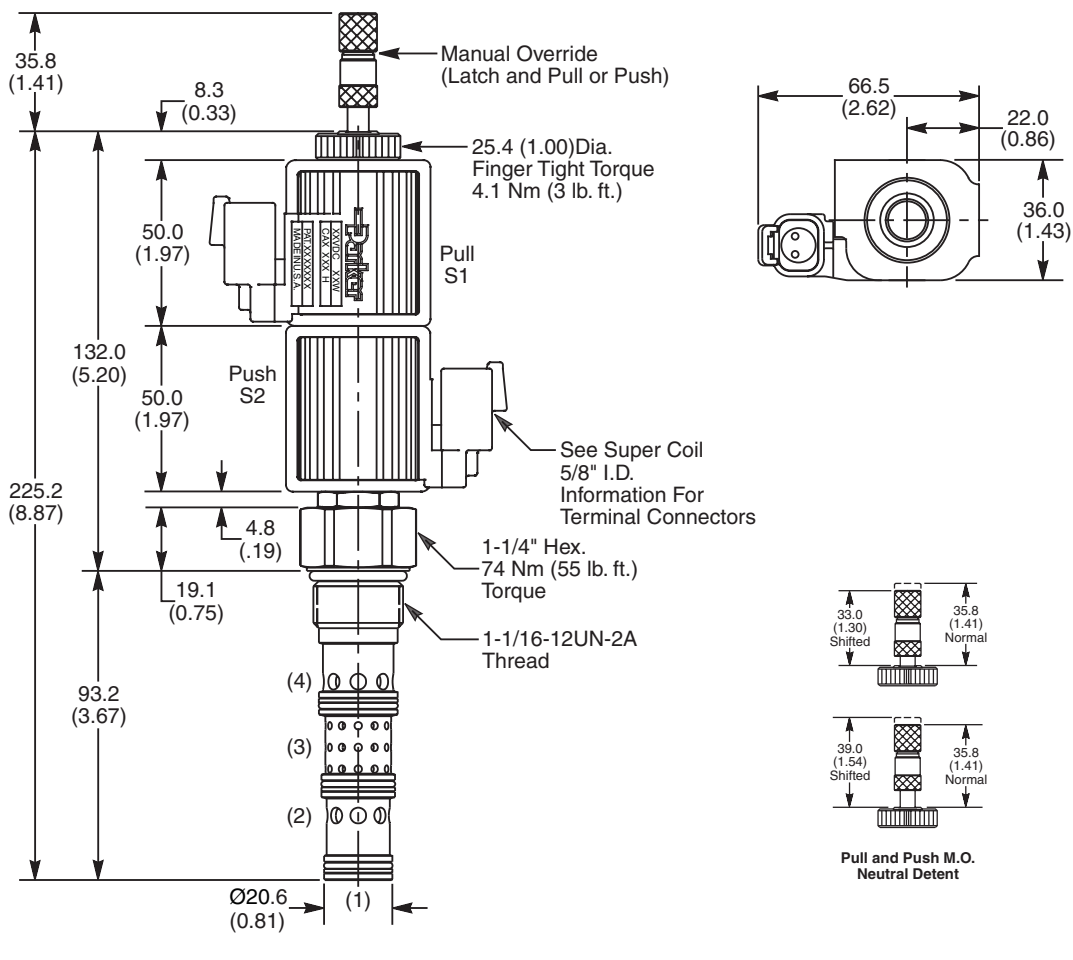

Ordering Information

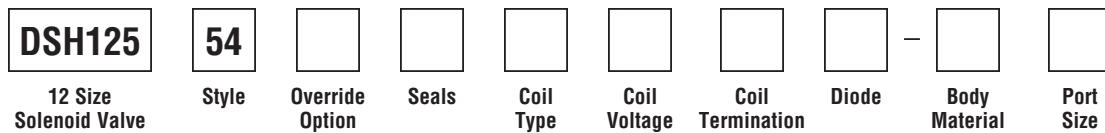

Code	Style
54	High Flow ("SP" Coil)

Code	Coil Type
Omit	Without Coil
SP	Super Coil - 28 Watts

Code	Coil Termination
Omit	Without Coil
C	Conduit With Leads
D	DIN Plug Face
S	Dual Spade*
L	Dual Lead Wire*
LS	Sealed Lead Wire*
H	Molded Deutsch*

Code	Body Material
Omit	Steel
A	Aluminum

Code	Override Options
Omit	None (Consult Factory)
DN	Latch Operated**

Code	Coil Voltage
Omit	Without Coil
D012	12 VDC
D024	24 VDC
A120	120 VAC, 60/50 Hz
A240	240 VAC, 60/50 Hz*

See Super Coil 5/8" I.D.
*DC Only

Code	Port Size	Body Part No.
Omit	Cartridge Only	
12T	SAE-12	(B12-4L-*12T)

* Add "A" for aluminum, omit for steel.

Code	Seals / Kit No.
N	Nitrile / Buna-N (Std.) (SK12-4LN)
V	Fluorocarbon / (SK12-4LV)

**22 Watts

Code	Diode
Omit	None
R	Diode



- CV Check Valves
- SH Shuttle Valves
- LM Load/Motor Controls
- FC Flow Controls
- PC Pressure Controls
- LE Logic Elements
- DC Directional Controls
- MV Manual Valves
- SV Solenoid Valves
- PV Proportional Valves
- CE Coils & Electronics
- BC Bodies & Cavities
- TD Technical Data

Technical Information

- CV** Check Valves
- SH** Shuttle Valves
- LM** Load/Motor Controls
- FC** Flow Controls
- PC** Pressure Controls
- LE** Logic Elements
- DC** Directional Controls
- MV** Manual Valves
- SV** Solenoid Valves
- PV** Proportional Valves
- CE** Coils & Electronics
- BC** Bodies & Cavities
- TD** Technical Data

General Description

4-Way, 3 Position, Tandem Center Spool Valve.
For additional information see Technical Tips on pages SV1-SV6.

Features

- Four way tandem center valve designed to operate double acting cylinders and bi-directional motors, etc.
- One piece cartridge housing ensures internal concentricity
- Coil: Waterproof, hermetically sealed, requires no O’Rings; Symmetrical coil can be reversed without affecting performance.
- All external parts zinc plated

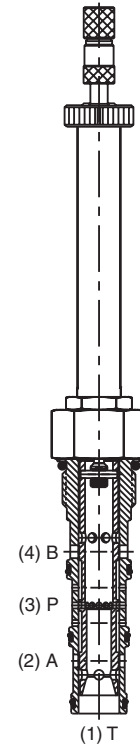
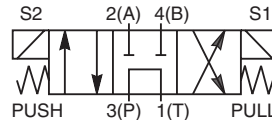
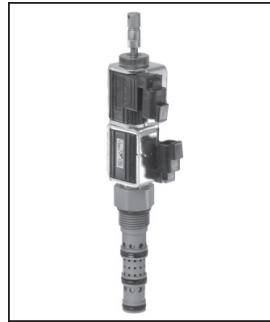

Specifications

Rated Flow (At 70 PSI ΔP)	57 LPM (15 GPM)	
Maximum Inlet Pressure	350 Bar (5000 PSI)	
Leakage at 150 SSU (32 cSt)	160 cc/min @ 210 Bar (3000 PSI)	
Minimum Operating Voltage	75% of rated voltage at 20°C (72°F).	
Response Time	Energized	30-60 ms
	De-Energized	20-40 ms
Cartridge Material	All parts steel. All operating parts hardened steel.	
Operating Temp. Range/Seals	-45°C to +93.3°C (Nitrile) (-50°F to +200°F) -31.7°C to +121.1°C (Fluorocarbon) (-25°F to +250°F)	
Fluid Compatibility/ Viscosity	Mineral-based or synthetic with lubricating properties at viscosities of 45 to 2000 SSU (6 to 420 cSt)	
Filtration	ISO Code 16/13, SAE Class 4 or better	
Approx. Weight	.45 kg (1.0 lbs.)	
Cavity	C12-4L (See BC Section for more details)	

Performance Curves
Pressure Drop vs. Flow
(Through cartridge only)

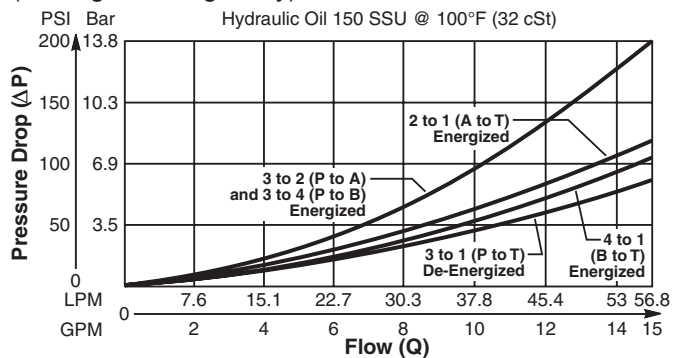

Shift Limit Characteristics (Min. Operating Voltage)

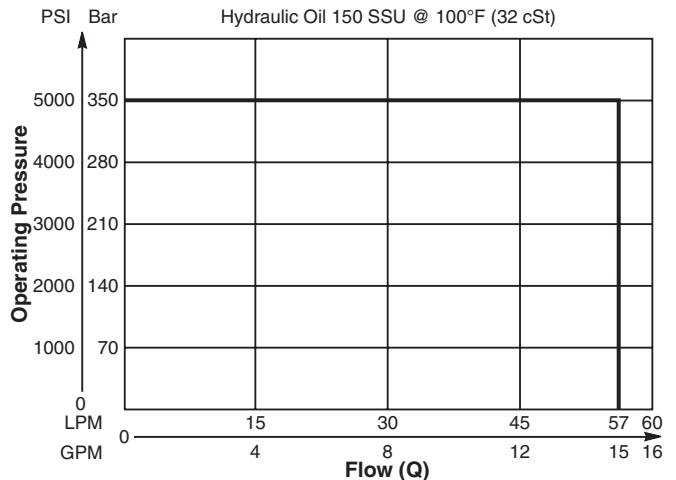

Technical Information

Dimensions Millimeters (Inches)

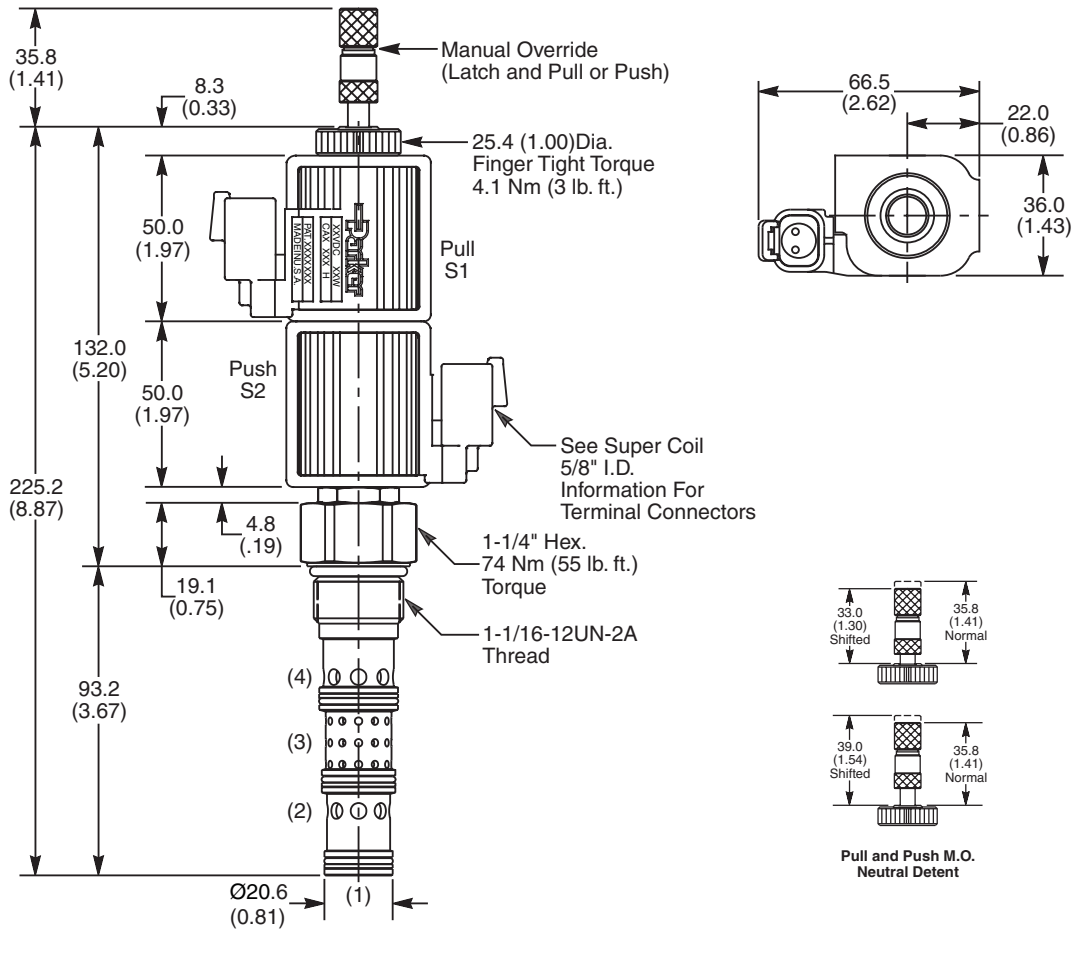

Ordering Information

DSH125	57								
12 Size Solenoid Valve	Style	Override Option	Seals	Coil Type	Coil Voltage	Coil Termination	Diode	Body Material	Port Size

Code	Style
57	High Flow ('SP' Coil)

Code	Coil Type
Omit	Without Coil
SP	Super Coil - 28 Watts

Code	Coil Termination
Omit	Without Coil
C	Conduit With Leads
D	DIN Plug Face
S	Dual Spade*
L	Dual Lead Wire*
LS	Sealed Lead Wire*
H	Molded Deutsch*

Code	Body Material
Omit	Steel
A	Aluminum

Code	Override Options
Omit	None (Consult Factory)
DN	Latch Operated**

Code	Coil Voltage
Omit	Without Coil
D012	12 VDC
D024	24 VDC
A120	120 VAC, 60/50 Hz
A240	240 VAC, 60/50 Hz*

See Super Coil 5/8" I.D.
*DC Only

Code	Port Size	Body Part No.
Omit	Cartridge Only	
12T	SAE-12	(B12-4L-*12T)

* Add "A" for aluminum, omit for steel.

Code	Seals / Kit No.
N	Nitrile / Buna-N (Std.) (SK12-4LN)
V	Fluorocarbon / (SK12-4LV)

**22 Watts

Code	Diode
Omit	None
R	Diode

- CV Check Valves
- SH Shuttle Valves
- LM Load/Motor Controls
- FC Flow Controls
- PC Pressure Controls
- LE Logic Elements
- DC Directional Controls
- MV Manual Valves
- SV Solenoid Valves
- PV Proportional Valves
- CE Coils & Electronics
- BC Bodies & Cavities
- TD Technical Data



Technical Information

- CV** Check Valves
- SH** Shuttle Valves
- LM** Load/Motor Controls
- FC** Flow Controls
- PC** Pressure Controls
- LE** Logic Elements
- DC** Directional Controls
- MV** Manual Valves
- SV** Solenoid Valves
- PV** Proportional Valves
- CE** Coils & Electronics
- BC** Bodies & Cavities
- TD** Technical Data

General Description

4-Way, 3 Position, Open Center Spool Valve.
For additional information see Technical Tips on pages SV1-SV6.

Features

- Four way open center valve designed to operate double acting cylinders and bi-directional motors, etc.
- One piece cartridge housing ensures internal concentricity
- Coil: Waterproof, hermetically sealed, requires no O’Rings; Symmetrical coil can be reversed without affecting performance.
- All external parts zinc plated

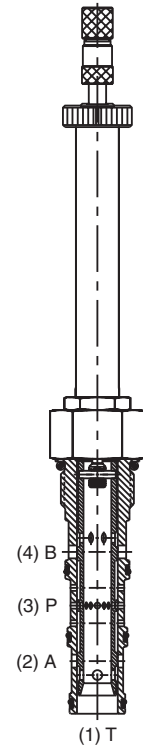
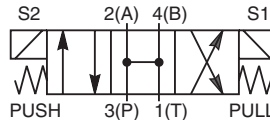
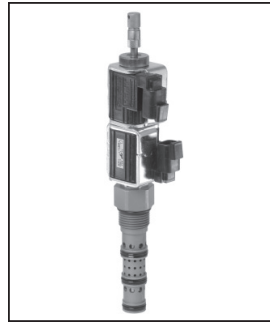

Specifications

Rated Flow (At 70 PSI ΔP)	57 LPM (15 GPM)	
Maximum Inlet Pressure	350 Bar (5000 PSI)	
Leakage at 150 SSU (32 cSt)	160 cc/min @ 210 Bar (3000 PSI)	
Minimum Operating Voltage	75% of rated voltage at 20°C (72°F).	
Response Time	Energized	30-60 ms
	De-Energized	20-40 ms
Cartridge Material	All parts steel. All operating parts hardened steel.	
Operating Temp. Range/Seals	-45°C to +93.3°C (Nitrile) (-50°F to +200°F) -31.7°C to +121.1°C (Fluorocarbon) (-25°F to +250°F)	
Fluid Compatibility/ Viscosity	Mineral-based or synthetic with lubricating properties at viscosities of 45 to 2000 SSU (6 to 420 cSt)	
Filtration	ISO Code 16/13, SAE Class 4 or better	
Approx. Weight	.45 kg (1.0 lbs.)	
Cavity	C12-4L (See BC Section for more details)	

Performance Curves
Pressure Drop vs. Flow
(Through cartridge only)

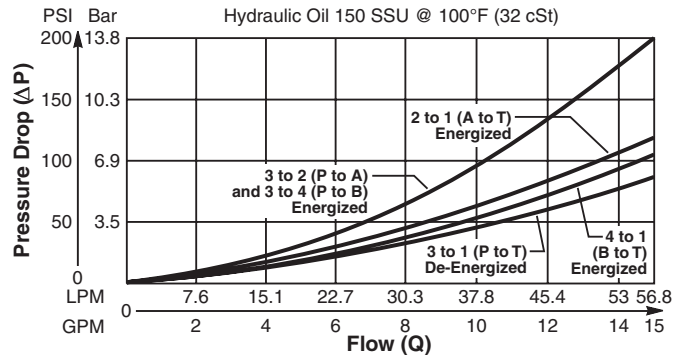

Shift Limit Characteristics (Min. Operating Voltage)

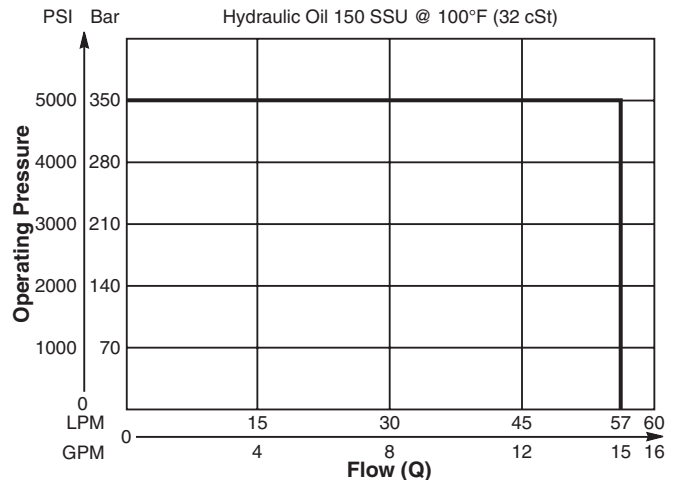

Technical Information

Dimensions Millimeters (Inches)

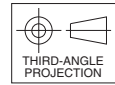
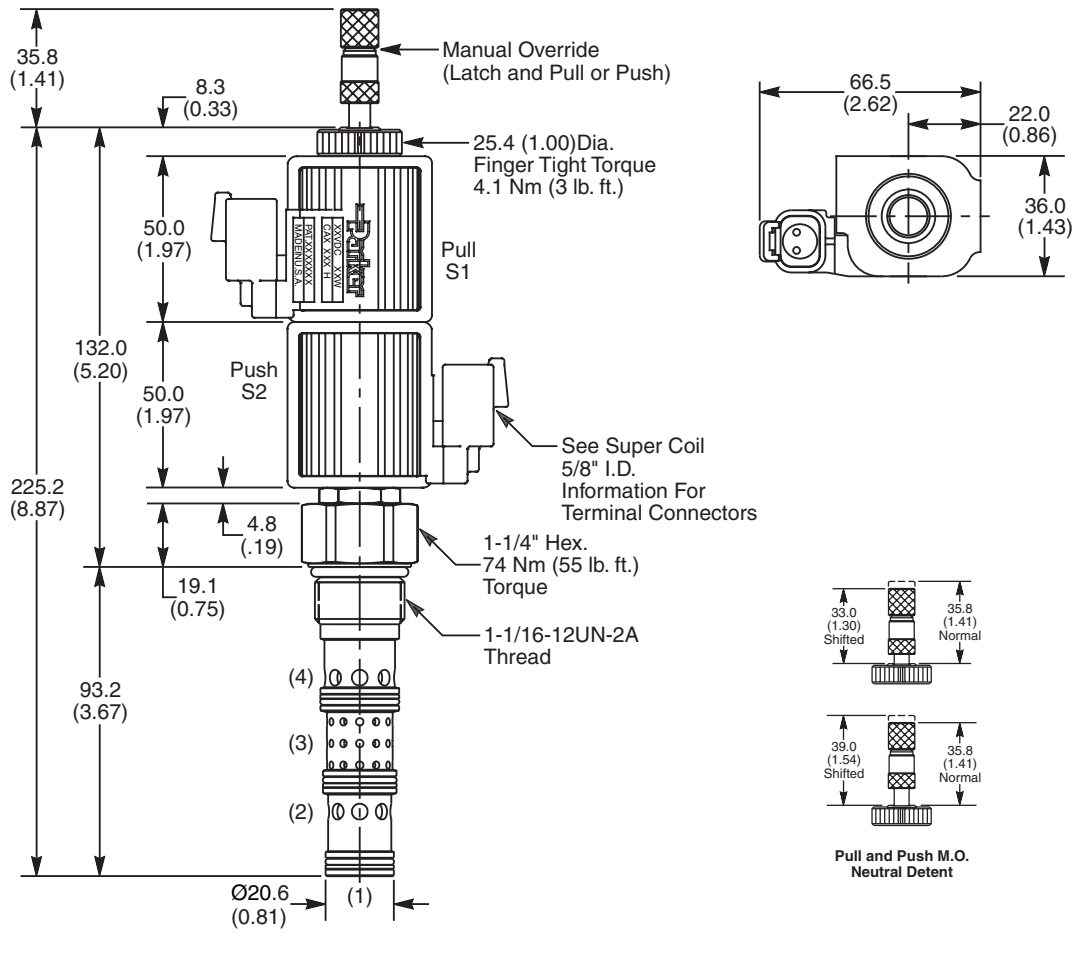

Ordering Information

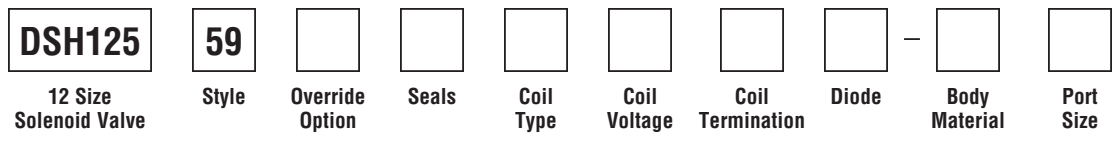

Code	Style
59	High Flow ("SP" Coil)

Code	Coil Type
Omit	Without Coil
SP	Super Coil - 28 Watts

Code	Coil Termination
Omit	Without Coil
C	Conduit With Leads
D	DIN Plug Face
S	Dual Spade*
L	Dual Lead Wire*
LS	Sealed Lead Wire*
H	Molded Deutsch*

Code	Body Material
Omit	Steel
A	Aluminum

Code	Override Options
Omit	None (Consult Factory)
DN	Latch Operated**

Code	Coil Voltage
Omit	Without Coil
D012	12 VDC
D024	24 VDC
A120	120 VAC, 60/50 Hz
A240	240 VAC, 60/50 Hz*

See Super Coil 5/8" I.D.
*DC Only

Code	Port Size	Body Part No.
Omit	Cartridge Only	
12T	SAE-12	(B12-4L-*12T)

* Add "A" for aluminum, omit for steel.

Code	Seals / Kit No.
N	Nitrile / Buna-N (Std.) (SK12-4LN)
V	Fluorocarbon / (SK12-4LV)

**22 Watts

Code	Diode
Omit	None
R	Diode



- CV
Check Valves
- SH
Shuttle Valves
- LM
Load/Motor Controls
- FC
Flow Controls
- PC
Pressure Controls
- LE
Logic Elements
- DC
Directional Controls
- MV
Manual Valves
- SV
Solenoid Valves
- PV
Proportional Valves
- CE
Coils & Electronics
- BC
Bodies & Cavities
- TD
Technical Data