

## Datasheet - BNS 16-11zV-ST3

Safety sensors / BNS 16



- thermoplastic enclosure
- Suitable for food processing industry
- Concealed mounting possible
- 52 mm x 90 mm x 32 mm
- Long life
- Insensitive to transverse misalignment
- no mechanical wear
- Insensitive to soiling
- Connector M12, 4-pole

(Minor differences between the printed image and the original product may exist!)

### Ordering details

Product type description	BNS 16-11ZV-ST3
Article number	BNS 16-11zV-ST3
EAN code	

### Approval

Approval



### Classification

Standards	EN ISO 13849-1
B <sub>10d</sub> Opener/Normally open contact (NC/NO)	25.000.000
- notice	at max. 20% contact load
Mission time	20 Years
notice	$MTTF_d = \frac{B_{10d}}{0,1 \times n_{op}}$ $n_{op} = \frac{d_{op} \times h_{cp} \times 3600 \text{ s/h}}{t_{cycle}}$

### Global Properties

Product name	BNS 16
Standards	IEC 60947-5-3, BG-GS-ET-14
Compliance with the Directives (Y/N) 	Yes
Materials	
- Material of the housings	Plastic, glass-fibre reinforced thermoplastic
Coding available (Y/N)	Yes
Monitoring function of downstream devices (Y/N)	No
Prerequisite evaluation unit	Yes
Recommended safety-monitoring module	AES 1135, AES 1136, AES 1165, AES 1166, AES 1165-2250, AES 1185, AES 1235, AES 1236, AES 1265, AES 1266, AES 1337, AES 2135, AES 2136, AES 2335, AES 2336, AES 2535, AES 2536, AES 2365, AES 2366, AES 2565, AES 2566, AES 2285, AES 3075, SRB 202C., SRB 400C.
Recommended actuator	BPS 16

### Mechanical data

---

Design of electrical connection connector	Connector M12 left
mechanical installation conditions	not flush
Active area	front side
Ensured switch distance ON	8 mm
Ensured switch distance OFF	18 mm
Type of actuation	Magnet
Direction of motion	head-on with regard to the active surface
restistance to shock	30 g / 11 ms
Resistance to vibration	10 ... 55 Hz, Amplitude 1 mm

### Ambient conditions

---

Ambient temperature	
- Min. environmental temperature	-25 °C
- Max. environmental temperature	+70 °C
Storage and transport temperature	
- Min. Storage and transport temperature	-25 °C
- Max. Storage and transport temperature	+70 °C
Protection class	IP67

### Electrical data

---

Integrated Safety monitoring module available (Y/N)	No
Cross circuit/short circuit recognition possible (Y/N)	Yes
Voltage type	VAC/DC
Switch frequency	max. 5 Hz
Switching voltage	max. 100 VAC/DC
Switching current	max. 400 mA
Switching capacity	max. 10 W

### Outputs

---

Design of control output	Other, Reed kontakts
Number of shutters	1 piece
Number of openers	1 piece

### Electrical data - Safety outputs

Number of secure semi-conductor outputs	0 piece
Number of secure outputs with contact	0 piece

### Electrical data - Diagnostic output

Number of semi-conductor outputs with signaling function	0 piece
Number of outputs with signaling function that already have a contact	0 piece

### LED switching conditions display

LED switching conditions display (Y/N)	No
--	----

### ATEX

Explosion protection categories for gases	None
Explosion protected category for dusts	None

### Dimensions

Dimensions of the sensor	
- Width of sensor	52 mm
- Height of sensor	90 mm
- Length of sensor	39 mm

### notice

Contact symbols shown for the closed condition of the guard device.

### Included in delivery

Actuators must be ordered separately.



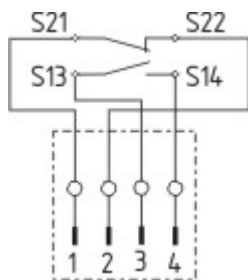

### Indication legend

5 different directions of actuation: cover, front and below, right and left

### Diagram



Note Diagram

-  positive break NC contact
-  active
-  no active
-  Normally-open contact

 Normally-closed contact

## Ordering code

---

BNS 16-(1)Z(2)-(3)

(1)

11 1 Normally open contact (NO) / 1 Opener (NC) (Only for Plug-in connection)

12 1 Normally open contact (NO) / 2 Opener (NC)

(2)

V Actuating planes front side

R Actuating planes right-hand side

L Actuating planes left-hand side

D Actuating planes cover-side

U Actuating planes bottom

LR Actuating planes left-hand side/right-hand side

(3)

ST1 Connector Middle

ST2 Connector right

ST3 Connector left

## Documents

---

**Operating instructions and Declaration of conformity** (en) 1 MB, 21.01.2010

Code: mrl\_bns16-st\_en

**Operating instructions and Declaration of conformity** (fr) 805 kB, 14.12.2009

Code: mrl\_bns16-st\_fr

**Operating instructions and Declaration of conformity** (pt) 348 kB, 04.07.2012

Code: mrl\_bns16-st\_pt

**Operating instructions and Declaration of conformity** (it) 803 kB, 14.12.2009

Code: mrl\_bns16-st\_it

**Operating instructions and Declaration of conformity** (nl) 807 kB, 14.12.2009

Code: mrl\_bns16-st\_nl

**Operating instructions and Declaration of conformity** (es) 805 kB, 14.12.2009

Code: mrl\_bns16-st\_es

**Operating instructions and Declaration of conformity** (de) 1 MB, 21.01.2010

Code: mrl\_bns16-st\_de

**Operating instructions and Declaration of conformity** (jp) 501 kB, 09.08.2011

Code: mrl\_bns16-st\_jp

**Operating instructions and Declaration of conformity** (da) 324 kB, 08.08.2012

Code: mrl\_bns16-st\_da

**Operating instructions and Declaration of conformity** (pl) 326 kB, 19.03.2012

Code: mrl\_bns16-st\_pl

Images

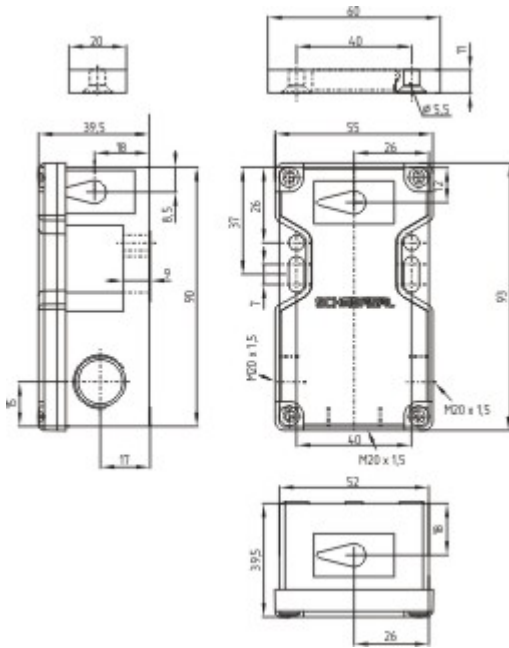

Dimensional drawing (basic component)

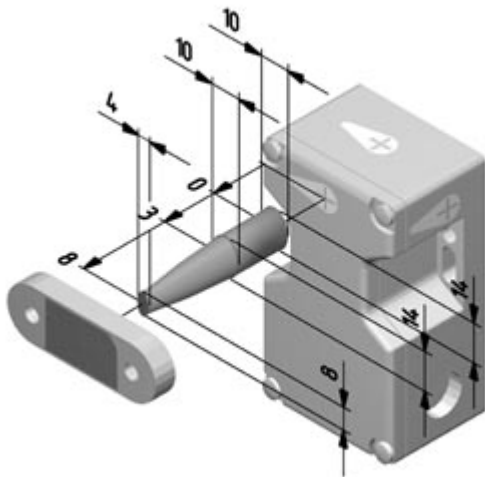

Dimensional drawing (miscellaneous)

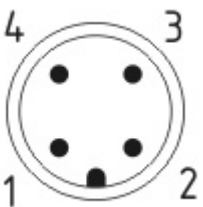

Contact arrangement



Operating principle

---

## System components

---

### Actuator

101172566 - BPS 16



### Connector

A-K4M12

- Pre-wired cable
- 4-pole



K.A. Schmersal GmbH & Co. KG, Mödinghofe 30, D-42279 Wuppertal

The data and values have been checked thoroughly. Technical modifications and errors excepted.

Generiert am 20.08.2014 - 22:48:47h Kasbase 2.2.18.F DBI

Image

Image  
et=sS