

Datasheet - BN 20-11Z

Magnetic reed switch / BN 20



Preferred typ



- Non-contact principle
- With pre-wired cable
- 2 reed contacts
- 1 Reed kontakts
- Long life
- 104 mm x 52 mm x 47 mm
- Aluminium enclosure
- Actuating distance up to 50 mm depending on actuating magnet and version
- Screw connection
- Highly resistant to vibration
- Available for actuation from front or side

(Minor differences between the printed image and the original product may exist!)

Ordering details

Product type description	BN 20-11Z
Article number	101168014
EAN code	4030661220161

Approval

Approval	-
----------	---

Global Properties

Product name	BN 20
Standards	-
Compliance with the Directives (Y/N) 	Yes
suitable for elevators (Y/N)	No
Active principle	Magnetic drive
Materials	
- Material of the housings	Aluminium
- Material of the active surface	Metal film
Housing construction form	rectangular
Weight	297 g
Recommended actuator	2 x BP 10, 2 x BP 15/2, BP 20, BP 31, BP 11, BP 12, BP 21 N, BE 20

Mechanical data

Design of electrical connection	Screw connection
Mechanical life	1.000.000.000 operations
Electrical lifetime	1.000.000 ... 1.000.000.000 operations
Switching frequency	max. 300/s
Actuating planes	Actuation from side
Active area	lateral
Switch distance S_n	12 mm ... 45 mm 2 x BP 10 = 12 mm 2 x BP 15/2 = 12 mm BP 20 = 15 mm BP 31 = 15 mm BP 11 = 15 mm BP 12 = 25 mm BP 21N = 20 ... 45 mm BE 20 = 15 mm
- notice	Actuating distance up to 45 mm depending on actuating magnet and version
Type of actuation	Magnet
resistance to shock	-
resistant to vibration	50 g, on sine wave oscillation
Bounce duration	0,3 ms ... 0,6 ms
Latching (Y/N)	No
bias magnet (Y/N)	Yes
Actuating speed	max. 18 m/s
Switching point accuracy	± 0,25 mm

Ambient conditions

Ambient temperature	
- Min. environmental temperature	-25 °C
- Max. environmental temperature	+90 °C
Protection class	IP67

Electrical data

Design of control element	Normally open contact (NO) / Opener (NC)
Number of shutters	1 piece
Number of openers	1 piece
Switching time - Close	0,3 ms ... 1.5 ms
Switching time - Open	max. 0,5 ms
Voltage type	VAC
Dielectric strength	> 600 VAC (50 Hz)
Switching voltage	max. 250 VAC
Switching current	max. 3 A
Switching capacity	max. 120 VA / W

Outputs

Design of control output	Reed contacts
--------------------------	---------------

LED switching conditions display

LED switching conditions display (Y/N)	No
--	----

ATEX

Explosion protection categories for gases	None
Explosion protected category for dusts	None

Dimensions

Dimensions of the sensor	
- Width of sensor	104 mm
- Height of sensor	52 mm
- Length of sensor	47 mm

notice

The opening and closing functions depend on the direction of actuation, the actuating magnets and the polarity of the actuating magnets. When the switches and actuators come together, the colours must coincide: Red (S) to red (S) and green (N) to green (N).



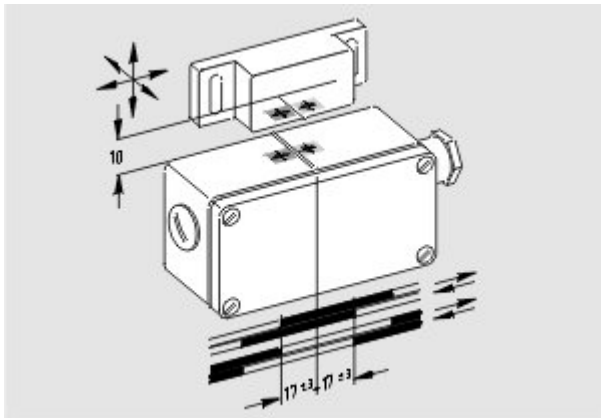

Included in delivery

Actuators must be ordered separately.

Diagram



Note Diagram

-  positive break NC contact
-  active
-  no active
-  Normally-open contact
-  Normally-closed contact

Documents

Declaration of conformity (en) 118 kB, 26.02.2014

Code: __bn_p01_en

Declaration of conformity (de) 188 kB, 10.07.2012

Code: __bn_p01

notice - Switch distance (de) 36 kB, 07.08.2009

Code: s_bnbsp01

notice - Switch distance (nl) 39 kB, 07.08.2009

Code: s_bnbsp04

notice - Switch distance (fr) 41 kB, 07.08.2009

Code: s_bnbsp03

notice - Switch distance (pt) 39 kB, 07.08.2009

Code: s_bnbsp10

notice - Switch distance (it) 40 kB, 07.08.2009

Code: s_bnbsp05

notice - Switch distance (es) 38 kB, 07.08.2009

Code: s_bnbsp09

Images

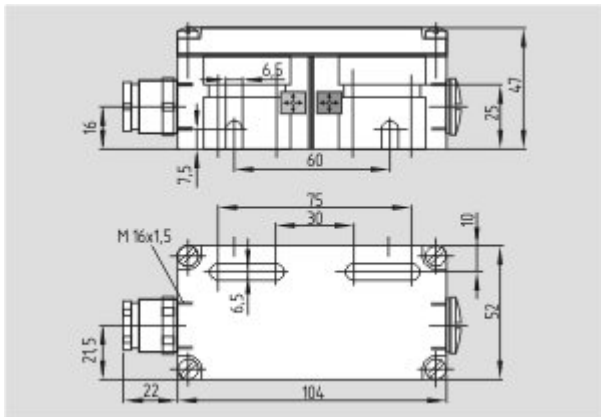

Dimensional drawing (basic component)

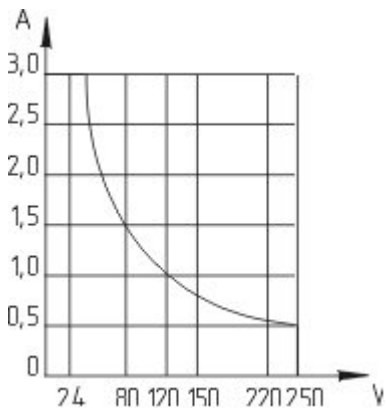

Characteristic curve

System components

Actuator

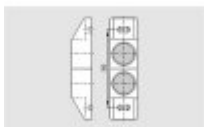

101059927 - BP 2x21 S

- Al-metal housing
- S-pole marked red
- Suitable for mounting on ferrous material

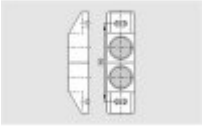

101059928 - BP 2x21 N

- Al-metal housing
- N-pole marked green
- Suitable for mounting on ferrous material



101057534 - BP 21 S

- Al-metal housing
- S-pole marked red
- Suitable for mounting on ferrous material



101057536 - BP 21 N

- Al-metal housing
- N-pole marked green
- Suitable for mounting on ferrous material

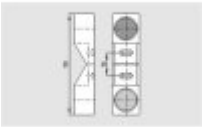

101059921 - BP 21

- Al-metal housing
- S-pole marked red
- N-pole marked green
- Suitable for mounting on ferrous material

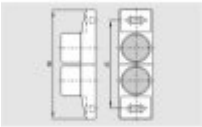

101059926 - BP 2x12 S

- Al-metal housing
- S-pole marked red
- Suitable for mounting on ferrous material

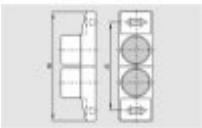

101059925 - BP 2x12 N

- Al-metal housing
- N-pole marked green
- Suitable for mounting on ferrous material

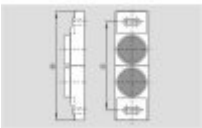

101059917 - BP 12 N

- Al-metal housing
- N-pole marked green
- Suitable for mounting on ferrous material

101059916 - BP 12

- Al-metal housing
- S-pole marked red
- N-pole marked green
- Suitable for mounting on ferrous material



101059930 - BP 2x11 S

- Al-metal housing
- S-pole marked red
- Suitable for mounting on ferrous material

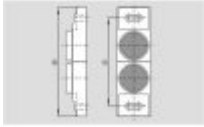

101059929 - BP 2x11 N

- Al-metal housing
- N-pole marked green
- Suitable for mounting on ferrous material

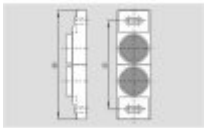

101057533 - BP 11 S

- Al-metal housing
- S-pole marked red
- Suitable for mounting on ferrous material

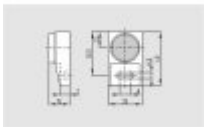

101059923 - BP 11 N

- Al-metal housing
- N-pole marked green
- Suitable for mounting on ferrous material

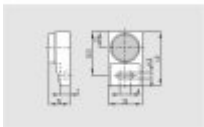

101059922 - BP 11

- Al-metal housing
- S-pole marked red
- N-pole marked green
- Suitable for mounting on ferrous material

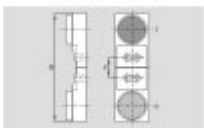

101057521 - BP 31 S

- thermoplastic enclosure
- S-pole marked red
- Suitable for mounting on ferrous material with a distance of 20 mm

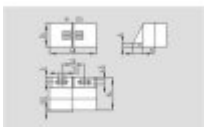

101057520 - BP 31 N

- thermoplastic enclosure
- N-pole marked green
- Suitable for mounting on ferrous material with a distance of 20 mm

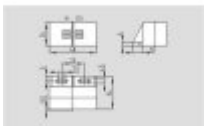

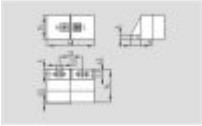

101057530 - BP 31

- thermoplastic enclosure
- S-pole marked red
- N-pole marked green
- Suitable for mounting on ferrous material with a distance of 20 mm

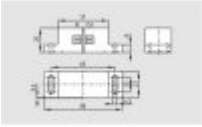

101057541 - BP 20 S

- Al-metal housing
- S-pole marked red
- Suitable for mounting on ferrous material with a distance of 20 mm

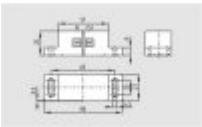

101057538 - BP 20 N

- Al-metal housing
- N-pole marked green
- Suitable for mounting on ferrous material with a distance of 20 mm

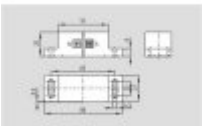

101057549 - BP 20

- Al-metal housing
- S-pole marked red
- N-pole marked green
- Suitable for mounting on ferrous material with a distance of 20 mm

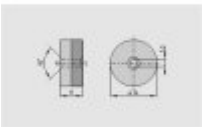

101057553 - BP 34

- thermoplastic enclosure
- S-pole marked red
- N-pole marked green
- Suitable for mounting on ferrous material with a distance of 25 mm



101060165 - BP 15/2

- Unenclosed
- Polarity stamped in
- Suitable for mounting on ferrous material with a distance of 18 mm



101060163 - BP 15

- thermoplastic enclosure
- N-pole marked green
- S-pole marked red
- Suitable for mounting on ferrous material with a distance of 18 mm

101057531 - BP 10

- Unenclosed
- Colour coding of poles by labels



K.A. Schmersal GmbH & Co. KG, Möddinghofe 30, D-42279 Wuppertal

The data and values have been checked thoroughly. Technical modifications and errors excepted.

Generiert am 16.08.2014 - 06:52:17h Kasbase 2.2.18.F DBI

Image

Image
et=sS
e