

polyflex[®] **Hose Products**

Ultra High Pressure Thermoplastic Hose

Catalog 4900 USA

January, 2006 REVISED

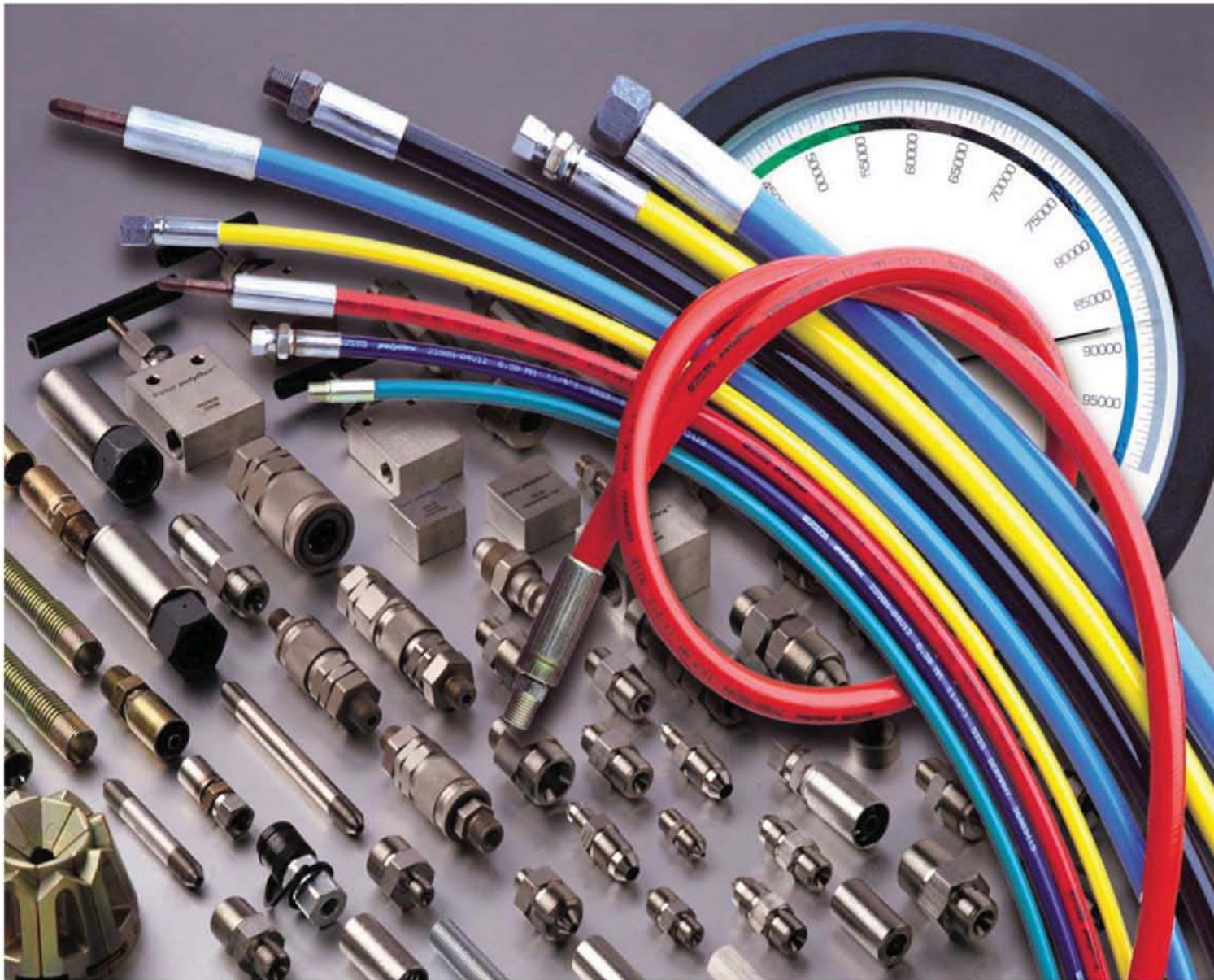

anything **Parker**
Possible.™

General Information	Section A	A
polyflex [®] Hose and Fittings	Section B	B
High Pressure Adapters and Valves	Section C	C
Quick Couplings	Section D	D
Accessories/Tooling	Section E	E
Technical Information	Section F	F
Alphanumeric Index	Section G	G
Offer of Sale	G8	

Table of Contents – Section A

Conversion Table	A2
Hose Selection Charts	A3
By Working Pressure 2.5:1	A3
By Working Pressure 4:1	A5
By Inside Diameter	A7
Hose Fitting Chart	A9
Hose Fitting Guide	A12
Hose Part Numbering System	A13
Hose End Fitting Part Numbering System	A13
Ordering Information	A14
Explanation of Symbols	A15



Conversion Table of Old and New Part Numbers of **polyflex®** Hose

Old Numbers	New Numbers	Old Numbers	New Numbers
1002 MK	2020N-012V30	4012 ST	2440N-08V30
1003 MK	2020N-02V30	4020 ST	2440N-12V37
1004 MK	2020N-025V30	4025 ST	2440N-16V37
1006 K	2040N-04V00		
2004 STR	2240D-025V34	6004 ST	2640D-025V32
2004 STV	2243D-025V70	6005 ST	2640D-03V32
2005 STR	2245D-03V32	6008 ST	2640D-05V32
2005 STV	2243D-03V70	6010 ST	2640N-06V32
2006 ST	2245N-04V00	6013 ST	2640N-08V32
2006 STA	2380N-04V33	6020 ST	2640N-12V32
2006 STV	2243D-04V70	6025 ST	2640N-16V32
2008 STT	2240D-05V32		
		6104 ST	2740D-025V30
2008 ST	2245N-05V00	6105 ST	2740D-03V30
2010 ST	2245N-06V00	6108 ST	2740D-05V32
2013 ST	2245N-08V00		
2016 ST	2245N-10V30	8005 ST	2840D-03V34
2020 ST	2245N-12V30		
2025 ST	2245N-16V30		
2032 ST	2244N-20V30		
2104 ST	2244N-025V00		
2106 ST	2380N-04V00		
2108 ST	2380N-05V00		
2113 ST	2244N-08V10		
2206 ST	2390N-04V10		
2210 ST	2390N-06V013		
2213 ST	2390N-08V13		
2220 ST	2390N-12V03		
2225 ST	2390N-16V12		
4004 ST	2440D-025V37		
4005 ST	2440D-03V37		
4006 ST	2440D-04V37		
4008 ST	2440N-05V37		
4010 ST	2440N-06V37		

Hose Selection Chart

By Working Pressure 2.5:1					
Working Pressure 2.5:1	Working Pressure 4:1	I.D. inch	O.D. inch	Hose Number	Page No.
6,380	3,990	1.25	1.73	2244N-20V30	B30
6,380	3,990	1.00	1.34	2245N-16V30	B45
6,380	3,987	0.76	1.12	2380F-12V07	B50
6,500	4,100	1.00	1.37	2390N-16V12	B69
6,500	4,100	1.00	1.37	2390N-16V13	B69
6,500	4,100	1.00	1.37	2390N-16V16	B69
6,960	4,350	0.75	1.13	2245N-12V30	B43
7,192	4,495	0.25	0.47	2040N-04V00	B6
7,540	4,710	0.50	0.81	2380F-08V07	B48
N/A	5,000	2.00	2.71	2440N-32V10	B89
8,100	5,575	0.81	1.14	2390N-12V03	B67
8,120	5,075	0.50	0.81	2245N-08V30	B41
8,700	5,440	0.40	0.67	2245N-06V00	B39
8,700	5,437	0.32	0.56	2380F-05V07	B47
9,280	5,800	0.08	0.20	2020N-02V30	B4
9,280	5,800	0.31	0.56	2245N-05V00	B37
10,000	N/A	1.50	2.80	2640N-24V80	B99
10,000	N/A	2.00	3.35	2640N-32V80	B101
10,300	6,450	0.40	0.70	2390N-06V13	B63
10,400	6,500	0.50	0.81	2390N-08V12	B65
10,400	6,500	0.50	0.81	2390N-08V13	B65
10,400	6,500	0.50	0.81	2390N-08V16	B65
10,440	6,525	0.25	0.50	2245N-04V00	B33
10,440	6,525	0.25	0.50	2245N-04V02	B33
10,440	6,525	0.25	0.50	2245N-04V04	B33
11,020	6,890	0.08	0.20	2020N-012V30	B3
12,000	7,500	0.25	0.52	2390N-04V10	B60
12,000	7,500	0.25	0.52	2390N-04V12	B60
12,000	7,500	0.25	0.52	2390N-04V16	B60
12,760	7,970	0.50	0.89	2244N-08V10	B28
12,760	7,970	0.50	0.89	2244N-08V71	B28
13,040	8,150	0.32	0.52	2240D-05V32	B18
13,050	N/A	1.00	1.46	2440N-16V37	B87
13,050	N/A	1.00	1.46	2440N-16V91	B87
13,200	8,250	0.25	0.50	2380N-04V33	B55
13,600	8,500	0.32	0.62	2380N-05V00	B58

A

Hose Selection Chart

By Working Pressure 2.5:1 – continued					
Working Pressure 2.5:1	Working Pressure 4:1	I.D. inch	O.D. inch	Hose Number	Page No.
14,000	8,750	0.25	0.50	2243D-04V70	B23
14,490	9,050	0.25	0.45	2240D-04V32	B15
14,500	N/A	0.81	1.19	2440N-12V37	B85
14,500	N/A	0.81	1.19	2440N-12V91	B85
15,080	N/A	0.50	0.91	2X90N-08V14	B115
15,950	9,970	0.12	0.28	2240D-02V32	B9
16,230	10,145	0.20	0.38	2240D-03V34	B13
16,240	10,150	0.17	0.36	2243D-025V70	B19
16,240	10,150	0.20	0.42	2243D-03V70	B20
16,240	10,150	0.20	0.42	2245D-03V32	B31
16,240	10,150	0.25	0.53	2380N-04V00	B52
16,240	10,150	0.25	0.53	2380N-04V02	B52
16,240	10,150	0.25	0.53	2380N-04V04	B52
16,240	10,150	0.25	0.53	2380N-04V71	B52
17,400	10,875	0.17	0.30	2240D-025V34	B10
17,400	10,870	0.17	0.38	2244N-025V00	B26
18,560	N/A	0.25	0.53	2X90N-04V14	B111
20,290	N/A	0.75	1.30	2640N-12V32	B97
20,290	N/A	0.75	1.30	2640N-12V71	B97
20,300	N/A	0.40	0.77	2440N-06V91	B82
18,850	N/A	0.50	0.88	2440N-08V30	B83
18,850	N/A	0.50	0.88	2440N-08V91	B83
21,750	N/A	0.32	0.61	2440D-05V37	B80
23,200	15,000	0.40	0.85	2X90N-06V14	B114
20,000	N/A	0.25	0.50	2440N-04V37	B77
20,000	N/A	0.25	0.50	2440N-04V91	B77
26,090	N/A	0.50	0.97	2640N-08V32	B95
26,100	N/A	0.20	0.45	2440D-03V37	B73
31,900	N/A	0.16	0.41	2440D-025V37	B71
36,000	N/A	0.50	*	2840D-08V30	B110
36,230	N/A	0.20	0.51	2640D-03V32	B93
36,230	N/A	0.32	0.67	2740D-05V32	B107
44,000	N/A	0.32	0.79	2840D-05V32	B109
40,600	N/A	0.16	0.45	2640D-025V32	B91
40,600	N/A	0.20	0.52	2740D-03V30	B105
45,000	N/A	0.16	0.48	2740D-025V30	B103
48,000	N/A	0.20	0.57	2840D-03V34	B108
55,000 *	N/A	0.20	1.00	2840D-03V34*	B108

Hose Selection Chart

By Working Pressure 4:1					
Working Pressure 4:1	Working Pressure 2.5:1	I.D. inch	O.D. inch	Hose Number	Page No.
3,987	6,380	0.76	1.12	2380F-12V07	B50
3,990	6,380	1.25	1.73	2244N-20V30	B30
3,990	6,380	1.00	1.34	2245N-16V30	B45
4,100	6,500	1.00	1.37	2390N-16V12	B69
4,100	6,500	1.00	1.37	2390N-16V13	B69
4,100	6,500	1.00	1.37	2390N-16V16	B69
4,350	6,960	0.75	1.13	2245N-12V30	B43
4,495	7,192	0.25	0.47	2040N-04V00	B6
4,710	7,540	0.50	0.81	2380F-08V07	B48
5,075	8,120	0.50	0.81	2245N-08V30	B41
5,437	8,700	0.32	0.56	2380F-05V07	B47
5,440	8,700	0.40	0.67	2245N-06V00	B39
5,575	8,100	0.81	1.14	2390N-12V03	B67
5,800	9,280	0.08	0.20	2020N-02V30	B4
5,800	9,280	0.31	0.56	2245N-05V00	B37
6,450	10,300	0.40	0.70	2390N-06V13	B63
6,500	10,400	0.50	0.81	2390N-08V12	B65
6,500	10,400	0.50	0.81	2390N-08V13	B65
6,500	10,400	0.50	0.81	2390N-08V16	B65
6,525	10,440	0.25	0.50	2245N-04V00	B33
6,525	10,440	0.25	0.50	2245N-04V02	B33
6,525	10,440	0.25	0.50	2245N-04V04	B33
6,890	11,020	0.08	0.20	2020N-012V30	B3
7,500	12,000	0.25	0.52	2390N-04V10	B60
7,500	12,000	0.25	0.52	2390N-04V12	B60
7,500	12,000	0.25	0.52	2390N-04V16	B60
7,970	12,760	0.50	0.89	2244N-08V10	B28
7,970	12,760	0.50	0.89	2244N-08V71	B28
8,150	13,040	0.32	0.52	2240D-05V32	B18
8,250	13,200	0.25	0.50	2380N-04V33	B55
8,500	13,600	0.32	0.62	2380N-05V00	B58
8,500	13,600	0.32	0.62	2380N-05V71	B58
8,750	14,000	0.25	0.50	2243D-04V70	B23
9,050	14,490	0.25	0.45	2240D-04V32	B15
9,970	15,950	0.12	0.28	2240D-02V32	B9
10,145	16,230	0.20	0.38	2240D-03V34	B13
10,150	16,240	0.17	0.36	2243D-025V70	B19

A

Hose Selection Chart

By Working Pressure 4:1 – continued					
Working Pressure 4:1	Working Pressure 2.5:1	I.D. inch	O.D. inch	Hose Number	Page No.
10,150	16,240	0.20	0.42	2243D-03V70	B20
10,150	16,240	0.20	0.42	2245D-03V32	B31
10,150	16,240	0.25	0.53	2380N-04V00	B52
10,150	16,240	0.25	0.53	2380N-04V02	B52
10,150	16,240	0.25	0.53	2380N-04V04	B52
10,150	16,240	0.25	0.53	2380N-04V71	B52
10,870	17,400	0.17	0.38	2244N-025V00	B26
10,875	17,400	0.17	0.30	2240D-025V34	B10
15,000	23,200	0.40	0.85	2X90N-06V14	B114
N/A	8,000	2.00	2.71	2440N-32V10	B89
N/A	10,000	2.00	2.80	2640N-24V80	B99
N/A	10,000	2.00	3.35	2640N-32V80	B99
N/A	13,050	1.00	1.46	2440N-16V37	B87
N/A	13,050	1.00	1.46	2440N-16V91	B87
N/A	14,500	0.81	1.19	2440N-12V37	B85
N/A	14,500	0.81	1.19	2440N-12V91	B85
N/A	15,080	0.50	0.91	2X90N-08V14	B115
N/A	18,560	0.25	0.53	2X90N-04V14	B111
N/A	20,290	0.75	1.30	2640N-12V32	B97
N/A	20,290	0.75	1.30	2640N-12V71	B97
N/A	20,300	0.40	0.77	2440N-06V91	B82
N/A	18,850	0.50	0.88	2440N-08V30	B83
N/A	18,850	0.50	0.88	2440N-08V91	B83
N/A	21,750	0.32	0.61	2440D-05V37	B80
N/A	20,000	0.25	0.50	2440N-04V37	B77
N/A	20,000	0.25	0.50	2440N-04V91	B77
N/A	26,090	0.50	0.97	2640N-08V32	B95
N/A	26,100	0.20	0.45	2440D-03V37	B73
N/A	31,900	0.16	0.37	2440D-025V37	B71
N/A	36,000	0.50	*	2840D-08V30	B110
N/A	36,230	0.20	0.51	2640D-03V32	B93
N/A	36,230	0.32	0.67	2740D-05V32	B107
N/A	44,000	0.32	0.79	2840D-05V32	B109
N/A	55,000*	0.32	1.40	2840D-05V32	B109
N/A	40,600	0.16	0.45	2640D-025V32	B91
N/A	40,600	0.20	0.52	2740D-03V30	B105
N/A	48,000	0.20	0.59	2840D-03V34	B108
N/A	55,000*	0.20	1.10	2840D-03V34*	B108

Hose Selection Chart



By Inside Diameter						
I.D. inch	I.D. mm	Working Pressure 2.5:1	Working Pressure 4:1	O.D. inch	Hose Number	Page No.
0.08	3	9,280	5,800	0.20	2020N-02V30	B4
0.08	2	11,020	6,890	0.20	2020N-012V30	B3
0.17	4	15,950	9,970	0.28	2240D-02V32	B9
0.17	4	31,900	N/A	0.37	2440D-025V37	B71
0.17	4	40,600	N/A	0.45	2640D-025V32	B91
0.17	4	45,000	N/A	0.48	2740D-025V30	B103
0.17	4	16,240	10,150	0.36	2243D-025V70	B19
0.17	5	17,400	10,875	0.30	2240D-025V34	B10
0.17	5	17,400	10,870	0.38	2244N-025V00	B26
0.20	5	16,230	10,145	0.38	2240D-03V34	B13
0.20	5	16,240	10,150	0.42	2243D-03V70	B20
0.20	5	16,240	10,150	0.42	2245D-03V32	B31
0.20	5	26,100	N/A	0.45	2440D-03V37	B73
0.20	5	36,230	N/A	0.51	2640D-03V32	B93
0.20	5	40,600	N/A	0.52	2740D-03V30	B105
0.20	5	48,000	N/A	0.57	2840D-03V34	B106
0.20	6	55,000*	N/A	1.10	2840D-03V34*	B108
0.25	6	7,192	4,495	0.47	2040N-04V00	B6
0.25	6	10,440	6,525	0.50	2245N-04V00	B33
0.25	6	10,440	6,525	0.50	2245N-04V02	B33
0.25	6	10,440	6,525	0.50	2245N-04V04	B33
0.25	6	12,000	7,500	0.52	2390N-04V10	B60
0.25	6	12,000	7,500	0.52	2390N-04V12	B60
0.25	6	12,000	7,500	0.52	2390N-04V16	B60
0.25	6	13,200	8,250	0.50	2380N-04V33	B55
0.25	6	14,000	8,750	0.50	2243D-04V70	B23
0.25	6	14,490	9,050	0.45	2240D-04V32	B15
0.25	6	16,240	10,150	0.53	2380N-04V00	B52
0.25	6	16,240	10,150	0.53	2380N-04V02	B52
0.25	6	16,240	10,150	0.53	2380N-04V04	B52
0.25	6	16,240	10,150	0.53	2380N-04V71	B52
0.25	6	18,560	N/A	0.53	2X90N-04V14	B109
0.25	6	20,000	N/A	0.50	2440N-04V37	B77
0.25	6	20,000	N/A	0.50	2440N-04V91	B77
0.31	8	9,280	5,800	0.56	2245N-05V00	B37
0.32	8	8,700	5,437	0.56	2380F-05V07	B47
0.17	4	13,040	8,150	0.52	2240D-05V32	B18

A

Hose Selection Chart

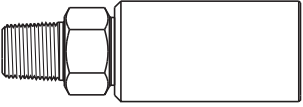
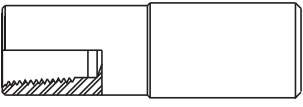
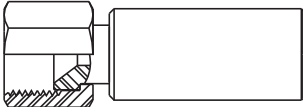
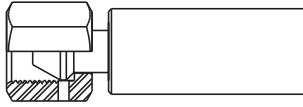
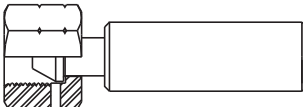
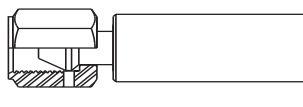
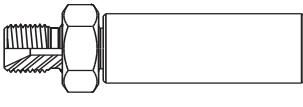

By Inside Diameter						
I.D. inch	I.D. mm	Working Pressure 2.5:1	Working Pressure 4:1	O.D. inch	Hose Number	Page No.
0.32	8	13,600	8,500	0.62	2380N-05V00	B58
0.32	8	13,600	8,500	0.62	2380N-05V71	B58
0.32	8	21,750	N/A	0.61	2440D-05V37	B80
0.32	8	36,230	N/A	0.67	2740D-05V32	B107
0.32	8	44,000	N/A	0.76	2840D-05V32	B109
0.40	10	8,700	5,440	0.67	2245N-06V00	B39
0.40	10	10,300	6,450	0.70	2390N-06V13	B63
0.40	10	23,200	15,000	0.85	2X90N-06V14	B114
0.40	10	20,300	N/A	0.77	2440N-06V91	B82
0.50	13	7,540	4,710	0.81	2380F-08V07	B48
0.50	13	8,120	5,075	0.81	2245N-08V30	B41
0.50	13	10,400	6,500	0.81	2390N-08V12	B65
0.50	13	10,400	6,500	0.81	2390N-08V13	B65
0.50	13	10,400	6,500	0.81	2390N-08V16	B65
0.50	13	12,760	7,970	0.89	2244N-08V10	B28
0.50	13	12,760	7,970	0.89	2244N-08V71	B28
0.50	13	15,080	N/A	0.91	2X90N-08V14	B115
0.50	13	18,850	N/A	0.88	2440N-08V30	B83
0.50	13	18,850	N/A	0.88	2440N-08V91	B83
0.50	13	26,090	N/A	0.97	2640N-08V32	B95
0.50	13	36,000	N/A	*	2840D-08V30	B110
0.75	20	6,960	4,350	1.13	2245N-12V30	B43
0.75	20	20,290	N/A	1.30	2640N-12V32	B97
0.75	20	20,290	N/A	1.30	2640N-12V71	B97
0.76	20	6,380	3,987	1.12	2380F-12V07	B50
0.81	20	8,100	5,575	1.14	2390N-12V03	B67
0.81	20	14,500	N/A	1.19	2440N-12V37	B85
0.81	20	14,500	N/A	1.19	2440N-12V91	B85
1.00	25	6,380	3,990	1.34	2245N-16V30	B45
1.00	25	6,500	4,100	1.37	2390N-16V12	B69
1.00	25	6,500	4,100	1.37	2390N-16V13	B69
1.00	25	6,500	4,100	1.37	2390N-16V16	B69
1.00	25	13,050	N/A	1.46	2440N-16V37	B87
1.00	25	13,050	N/A	1.46	2440N-16V91	B87
1.25	32	6,380	3,990	1.73	2244N-20V30	B30
2.00	50	N/A	5,000	2.71	2440N-32V10	B89
2.00	50	10,000	5,000	2.80	2640N-24V80	B99
2.00	50	10,000	N/A	3.35	2640N-32V80	B101

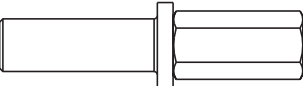
Hose Fitting Chart

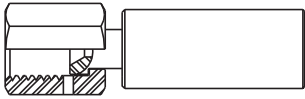
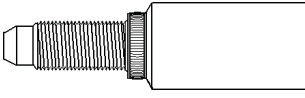
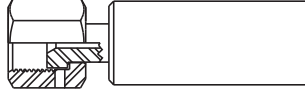

Fitting	Fitting Description	Fitting Designation
	National Pipe Tapered (NPT) Male Fitting	01
	National Pipe Tapered(NPT) Female Fitting	02
	JIC Female Swivel Fitting	06
	Type "M" Female Swivel Fitting	AY
	BSP Female Swivel Fitting	BC or 92
	Metric Female Swivel Fitting	C3 or C9
	BSP Male Fitting	D9 or 3B
	Male Stecko Fitting	MB
	Tube Stub Fitting	TU

A

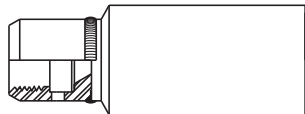
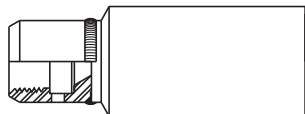
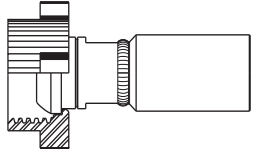
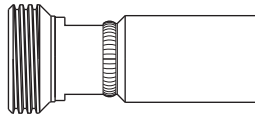
Hose Fitting Chart

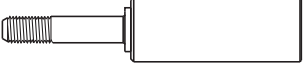

Fitting	Fitting Description	Fitting Designation
	Male Water Jetting Nozzle	ZE or 3Z
	Medium Pressure Female Swivel	5Y
	Nozzle Nipple	YH
	High Pressure Female Swivel	6Y
	Right Hand Male for Water Jetting Nozzle Fitting	call polyflex for update
	Right Hand Female for Water Jetting Nozzle Fitting	HY-RH
	Left Hand Female for Water Jetting Nozzle Fitting	HY-LH
	2" Hammer Union (Male) Cone with Wing Nut End Fitting	HE
	2" Hammer Union (Female) Cone Threaded End with Seal	HN

Hose Fitting Chart

Fitting	Fitting Description	Fitting Designation
	High Pressure Tube Nipple	Y4 or YM
	Medium Pressure Tube Nipple	Y2

A

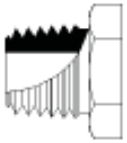
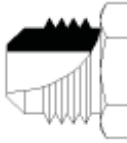
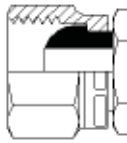
Hose Fitting Guide

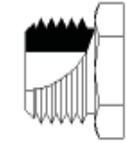
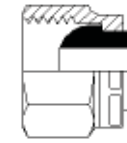
Parflex Style Number						
Dash Size	NPTF Pipe Thread Size	SAE (JIC) 37° Flare Thread Size	Metric Swivel Female Thread Size	Metric Swivel Female Thread Size	Male BSPP Thread Size	BSP Swivel Female Thread Size
2	1/8-27	5/16-24	—	—	—	—
3	—	3/8-24	—	—	—	—
4	1/4-18	7/16-20	—	—	1/4"	1/4"
5	—	1/2-20	—	—	—	—
6	3/8-18	9/16-18	M12 x 1.5	—	3/8"	3/8"
8	1/2-14	3/4-16	M14 x 1.5	M16 x 1.5	1/2"	1/2"
10	—	7/8-14	M16 x 1.5	M18 x 1.5	—	5/8"
12	3/4-14	1 1/16-12	M18 x 1.5	M20 x 1.5	3/4"	3/4"
—	—	—	—	—	—	—
14	—	1 3/16-12	—	M22 x 1.5	—	—
15	—	—	M22 x 1.5	—	—	—
16	1-11 1/2	1 5/16-12	—	M24 x 1.5	1 "	1 "
18	—	—	—	—	—	—
20	1 1/4-11 1/2	1 5/8-12	M26 x 1.5	—	—	—
22	—	—	—	M30 x 2	—	—
24	1 1/2-11 1/2	1 7/8-12	—	—	—	—
25	—	—	M30 x 2	—	—	—
—	—	—	—	M36 x 2	—	—
28	—	—	—	—	—	—
30	—	—	M36 x 2	—	—	—
32	2-11 1/2	2 1/2-12	—	M42 x 2	—	—
33	—	—	—	—	—	—

Hose Part Numbering System



2440 N - 16 V37

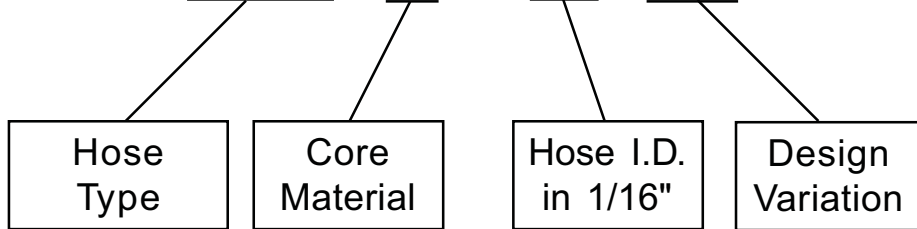

Hose End Fitting Part Numbering System

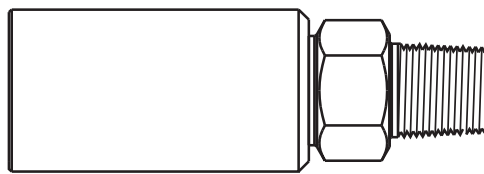

6 0 1 LX - 8 - 8 C

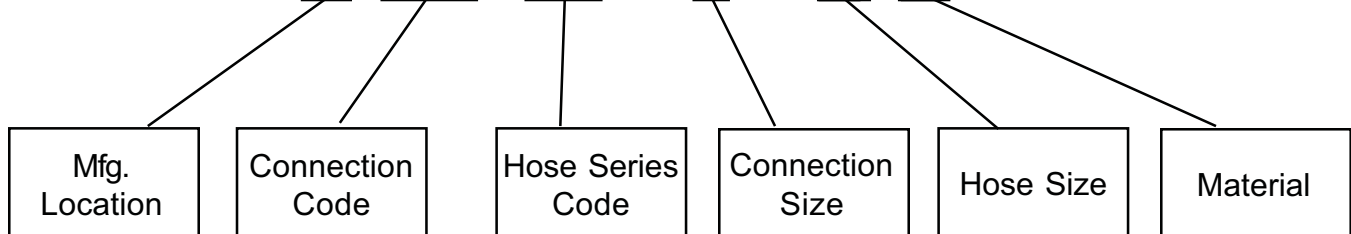

How to Order **polyflex** Hose Assemblies

Example Hose Assembly Number: **2244NAYAY111108C10-600**

2244N
(A)

AY AY
(B)

11 11
(C)

08
(D)

C
(E)

10
(F)

- XXX
Indicate Length
in Inches

A
This series of numbers will indicate the hose base number.

Examples:

2040N - 02
2040N - 04

2240D - 025
2245D - 03
2243D - 03

2390N - 04
2390N - 06
2390N - 08
2390N - 12

2440D - 025
2440D - 05
2440N - 08
2440N - 12

2640N - 08
2640N - 12

2740D - 03
2740D - 05

2840D - 03

B
These two letters will indicate the **STYLE** of connection.
End 1 & End 2

01 = NPT Pipe, Male, Rigid
02 = NPT Pipe; Female Rigid
06 = JIC 37 degree.; Female Swivel
07 = NPSM Pipe; Female Swivel 60°
92 = BSP Pipe; Female Swivel
AY = Type M; Female Swivel 58°
YA = Type M; Male (adaptor ends)
C9 = Metric; Female, Swivel 24/O-Ring
D9 = BSP; Male, Rigid
Y1 = MP Nipple; Male, w/ GNut & Collar
Y2 = MP Nipple; Male, wo/ GNut & Collar
Y3 = HP Nipple; Male, w/ GNut & Collar
Y4 = HP Nipple; Male, wo/ GNut & Collar
Y5 = MP Flare; Male, Rigid
Y6 = HP Flare; Male, Rigid
5Y = MP Flare; Female
6Y = HP Flare; Female

C
This part will contain a dash followed by a one or two digit number indicating the end connection size.
End 1 & End 2

UNF
1 = 1/4" - 28 UNF
2 = 5/16" - 24 UNF
3 = 3/8" - 24 UNF
4 = 7/16" - 20 UNF
5 = 1/2" - 20 UNF
6 = 9/16" - 18 UNF
7 = 5/8" - 18 UNF
8 = 3/4" - UNF
9 =
10 = 7/8" - 14 UNF
11 = 1" - 12 UNF
12 = 1 1/16" - 12 UNF
13 = 1 1/8" - 12 UNF
14 =
15 = 1 1/4" - 12 UNF
16 = 1 5/16" - 12 UNF
17 = 1 3/8" - 12 UNF
18 =
19 = 1 1/2" - 12 UNF
20 = 1 5/8" - 12 UNF

NPT
1 = 1/16-27
2 = 1/8-27
4 = 1/4-18
6 = 3/8-18
8 = 1/2-14
12 = 3/4-14
16 = 1-11 1/2
20 = 1 1/4-11 1/2
24 = 1 1/2-11 1/2
32 = 2-11 1/2

Medium and High Pressure Tube
Male or female, sized by nominal tube O.D.
04 = 1/4" tube
06 = 3/8" tube
09 = 9/16" tube
12 = 3/4" tube
16 = 1" tube

D
When specifying hose size, indicate the two digit code.

Hose Dash Size	Code
01	01
012	1A
02	02
025	2B
03	03
04	04
05	05
06	06
08	08
10	10
12	12
16	16
20	20
24	24
32	32

E
Indicate the fitting material.

S = Steel
B = Brass
C = Stainless Steel

F
This series of numbers will indicate the hose Variation Number.

Examples:

2040N - 02 **V00**
2020N - 02 **V30**

2240D - 025 **V34**
2245N - 16 **V30**
2245N - 20 **V30**
2244N - 025 **V00**
2244N - 08 **V10**

2380N - 04 **V33**
2380N - 04 **V00**
2380N - 05 **V00**

2440N - 08 **V37**
2440N - 12 **V37**
2440N - 16 **V37**
2440N - 24 **V80**
2440N - 32 **V80**

2640D - 025 **V32**
2640N - 12 **V32**
2640N - 32 **V80**

2740D - 03 **V30**
2740D - 05 **V32**

2840D - 03 **V34**

Explanation of Symbols Used in Hose and Fitting Tables

A











Symbol	Definition	Symbol	Definition
#	Part Number		Thickness
	Hose I.D.		Weight
	Hose O.D.		Thread Size
	Working Pressure		Hex Size
	Minimum Burst Pressure		Diameter
	Minimum Bend Radius		Elongation

Table of Contents – Section B

2000 Series

2020N-012	B3
2020N-02	B4
2040N-04	B6

2200 Series

2240D-02	B9
2240D-025	B10
2240D-03	B13
2240D-04	B15
2240D-05	B18
2243D-025	B19
2243D-03	B20
2243D-04	B23
2244N-025	B26
2244N-08	B28
2244N-20	B30
2245D-03	B31
2245N-04	B33
2245N-05	B37
2245N-06	B39
2245N-08	B41
2245N-12	B43
2245N-16	B45

2300 Series

2380F-05	B47
2380F-08	B48
2380F-12	B50
2380N-04	B52
2380N-04	B55
2380N-05	B58
2390N-04	B60
2390N-06	B63
2390N-08	B65
2390N-12	B67
2390N-16	B69

(Continued)

 Contact Parflex for current price and delivery information on shaded parts.

Table of Contents – Section B (continued)

2400 Series	
2440D-025	B71
2440D-03	B73
2440N-04	B77
2440D-05	B80
2440N-06	B82
2440N-08	B83
2440N-12	B85
2440N-16	B87
2440N-32	B89
2600 Series	
2640D-025	B91
2640D-03	B93
2640N-08	B95
2640N-12	B97
2640N-24	B99
2640N-32	B101
2700 Series	
2740D-025	B103
2740D-03	B105
2740D-05	B107
2800 Series	
2840D-03	B108
2840D-05	B109
2840D-08	B110
2X00 Series	
2X90N-04	B111
2X90N-06	B114
2X90N-08	B115
2X90N-12	B116
57CR Series	
57CRN	B118
HP Series	
HP/HP8	B119
Twin Lines	
2445N-04	B122
2380N-04	B125
Bundles	B129

2020N-012 **polyflex** Hose

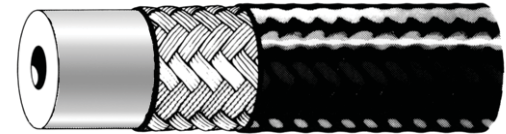

Part Number	Jacket Color	Minimum I.D.		Maximum O.D.		Maximum Working Pressure with 2.5:1		Maximum Working Pressure with 4:1		Minimum Burst Pressure		Minimum Bend Radius		Weight	
		inch	mm	inch	mm	psi	MPa	psi	MPa	psi	MPa	inch	mm	lbs/ft	kg/m
#															
2020N-012V30	Black	0.08	2	0.20	5	11,020	76.0	6,890	47.5	27,550	190.0	0.79	20	0.04	0.05

B

Construction: Polyamide core tube, high tensile synthetic fiber reinforced and a polyamide outer cover.

Temperature Range: -40°F and +140°F (-40°C and +60°C). Contact **polyflex** for temperatures outside this range.

Typical Applications: Small diameter, extremely flexible hose. Replaces steel tubing in instrumentation, diagnostic, hydraulic workholding, and testing applications.

National Pipe Tapered (NPT) Male Fitting 01

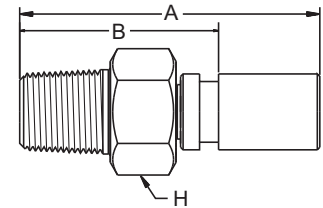

Part Number	Connection Type Thread Size	A Overall Length		B Cutoff Allowance		H Hex Size		Maximum Working Pressure	
		inch	mm	inch	mm	inch	mm	psi	MPa
#									
601EX-2-012	1/8" NPT	1.37	35	0.93	24	0.44	11	11,020	76.0
601EX-4-012	1/4" NPT	1.48	38	1.03	26	0.63	16	11,020	76.0

JIC Female Swivel Fitting 06

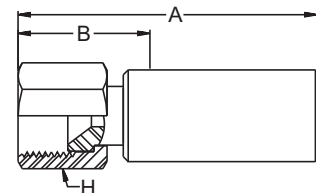

Part Number	Connection Type Thread Size	A Overall Length		B Cutoff Allowance		H Hex Size		Maximum Working Pressure	
		inch	mm	inch	mm	inch	mm	psi	MPa
#									
106EX-4-012	7/16" - 20	1.24	31	0.79	20	0.59	15	10,000	69.0

2020N-02 **polyflex** Hose

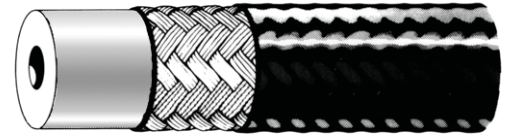

Part Number	Jacket Color	Minimum I.D.		Maximum O.D.		Maximum Working Pressure with 2.5:1		Maximum Working Pressure with 4:1		Minimum Burst Pressure		Minimum Bend Radius		Weight	
		inch	mm	inch	mm	psi	MPa	psi	MPa	psi	MPa	inch	mm	lbs/ft	kg/m
#															
2020N-02V30	Black	0.12	3	0.24	6	9,280	64.0	5,800	40.0	23,200	160.0	1.18	30	0.05	0.07

Construction: Polyamide core tube, high tensile synthetic fiber reinforced and a polyamide outer cover.

Typical Applications: Small diameter, extremely flexible hose. Replaces steel tubing in instrumentation, diagnostic mini-hydraulic systems, and testing applications.

Temperature Range: -40°F and +140°F (-40°C and +60°C). Contact **polyflex** for temperatures outside this range.

Available in bulk quantities with Field Attachable end fittings or as factory made and tested assemblies.

National Pipe Tapered (NPT) Male Fitting

01

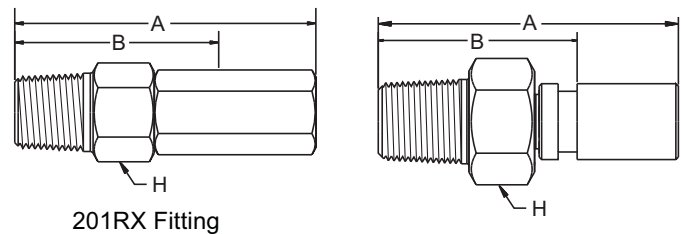





201RX Fitting

Part Number	Connection Type Thread Size	A Overall Length		B Cutoff Allowance		H Hex Size		Maximum Working Pressure	
		inch	mm	inch	mm	inch	mm	psi	MPa
#									
601EX-2-2	1/8" NPT	1.33	34	0.93	24	0.44	11	9,280	64.0
201RX-2-2C	1/8" NPT	1.54	39	1.10	28	0.44	11	5,000	34.5

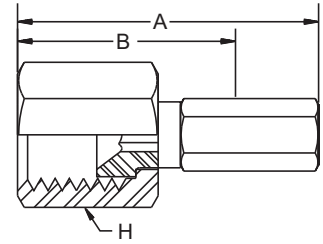
JIC Female Swivel Fitting

06





Part Number	Hose Size	Connection Type Thread Size	A Overall Length		B Cutoff		H Hex Size		Maximum Working	
			inch	mm	inch	mm	inch	mm	psi	MPa
#										
206RX-4-2C	0.12	7/16" - 20	1.56	40	1.10	28	0.56	14	5,000	34.5

B

Tube Stub Fitting

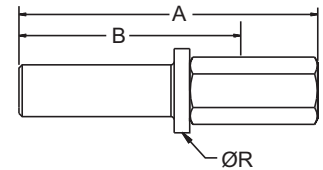
TU

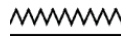

Part Number	Hose Size	Connection Type Thread Size	A Overall Length		B Cutoff		H Hex Size		Maximum Working	
			inch	mm	inch	mm	inch	mm	psi	MPa
#										
2TURX-4-2C	0.12	1/4" TUBE	1.65	42	1.20	30	0.38	10	5,000	34.5

2040N-04 **polyflex** Hose

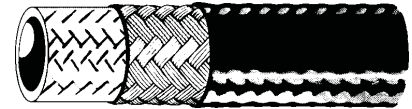

Part Number	Jacket Color	Minimum I.D.		Maximum O.D.		Maximum Working Pressure with 2.5:1		Maximum Working Pressure with 4:1		Minimum Burst Pressure		Minimum Bend Radius		Weight	
		inch	mm	inch	mm	psi	MPa	psi	MPa	psi	MPa	inch	mm	lbs/ft	kg/m
#															
2040N-04V00	Black	0.25	6	0.47	12	7,192	49.6	4,495	31.0	17,980	124.0	1.58	40	0.11	0.16

Construction: Polyamide core tube, one braided layer of high tensile steel wire and a polyurethane outer cover.

Temperature Range: -40°F and +140°F (-40°C and +60°C). Contact **polyflex** for temperatures outside this range.

Typical Applications: For use with petroleum or synthetic hydraulic fluids and pressure testing equipment.

National Pipe Tapered (NPT) Male Fitting 01

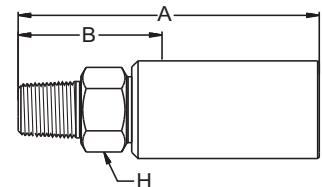

Part Number	Connection Type Thread Size	A Overall Length		B Cutoff Allowance		H Hex Size		Maximum Working Pressure	
		inch	mm	inch	mm	inch	mm	psi	MPa
#									
101PX-4-4	1/4" NPT	2.18	55	1.04	26	0.56	14	7,192	49.6
601NX-4-4C	1/4" NPT	2.38	60	1.12	28	0.63	16	7,192	49.6

Type "M" Female Swivel Fitting AY

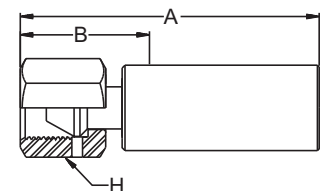

Part Number	Connection Type Thread Size	A Overall Length		B Cutoff Allowance		H Hex Size		Maximum Working Pressure	
		inch	mm	inch	mm	inch	mm	psi	MPa
#									
6AYNX-6-4C	9/16" - 18	2.36	60	1.11	28	0.68	17	7,192	49.6

JIC Female Swivel Fitting

06

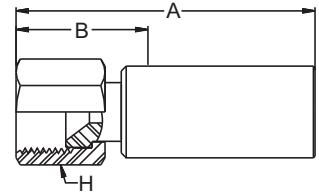

Part Number	Connection Type Thread Size	A Overall Length		B Cutoff Allowance		H Hex Size		Maximum Working Pressure	
		inch	mm	inch	mm	inch	mm	psi	MPa
#									
106PX-4-4	9/16" - 18	2.10	53	0.98	25	0.68	17	7,192	49.6
606NX-4-4C	7/16" - 20	2.23	57	0.99	25	0.63	16	7,192	49.6
606NX-6-4C	9/16" - 18	2.36	60	1.11	28	0.68	17	7,192	49.6

B

BSP Female Swivel Fitting

BC

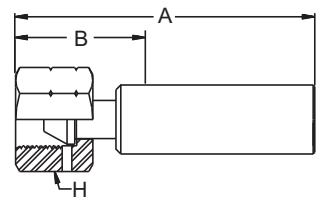

Part Number	Connection Type Thread Size	A Overall Length		B Cutoff Allowance		H Hex Size		Maximum Working Pressure	
		inch	mm	inch	mm	inch	mm	psi	MPa
#									
1BCPX-4-4	1/4" BSPP	2.00	51	0.88	22	0.66	17	7,192	49.6

Metric Female Swivel Fitting

C3

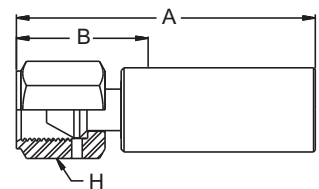



Part Number	Connection Type Thread Size	A Overall Length		B Cutoff Allowance		H Hex Size		Maximum Working Pressure	
		inch	mm	inch	mm	inch	mm	psi	MPa
#									
1C3PX-8-4	M14 x 1.5	1.98	50	0.85	22	0.75	19	7,192	49.6

BSP Male Fitting

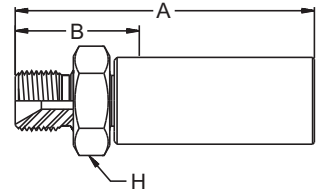
D9

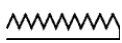



Part Number	Connection Type Thread Size	A Overall Length		B Cutoff Allowance		H Hex Size		Maximum Working Pressure	
		inch	mm	inch	mm	inch	mm	psi	MPa
#									
1D9PX-4-4	1/4" BSPP	2.26	57	1.23	31	0.75	19	7,192	49.6

Male Stecko Fitting

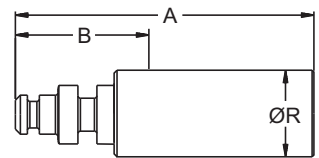
MB

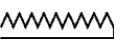

Part Number	Connection Type Thread Size	A Overall Length		B Cutoff Allowance		R Diameter		Maximum Working Pressure	
		inch	mm	inch	mm	inch	mm	psi	MPa
#									
1MBPX-6-4	N/A	2.52	64	1.40	36	0.54	14	7,192	49.6

2240D-02 **polyflex** Hose

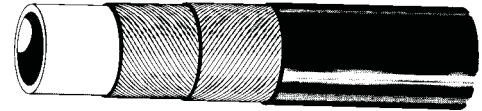

Part Number	Jacket Color	Minimum I.D.		Maximum O.D.		Maximum Working Pressure with 2.5:1		Maximum Working Pressure with 4:1		Minimum Burst Pressure		Minimum Bend Radius		Weight	
		inch	mm	inch	mm	psi	MPa	psi	MPa	psi	MPa	inch	mm	lbs/ft	kg/m
#															
2240D-02V32	Blue	0.12	3	0.28	7	15,950	110.0	9,969	68.8	39,875	275.0	2.36	60	0.047	0.07

B

Construction: Polyoxymethylene core tube, high strength wire reinforced and a polyamide cover.

Temperature Range: -40°F and +140°F (-40°C and +60°C). Contact for temperatures outside this range.

Typical Applications: Small diameter flexible hose, ideal for tight routing applications such as high pressure heat exchanger tube cleaning in petrochemical and power plants.

National Pipe Tapered (NPT) Male Fitting 01

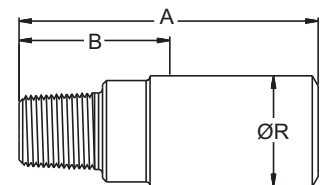

*ProLance® fitting

Part Number	Connection Type Thread Size	A Overall Length		B Cutoff Allowance		R Diameter		Maximum Working Pressure	
		inch	mm	inch	mm	inch	mm	psi	MPa
#									
601PL-1-2 *	1/16" NPT	1.06	27	0.47	12	0.38	10	15,000	103.4

*ProLance® fitting

Female Water Jetting Nozzle Fitting HY

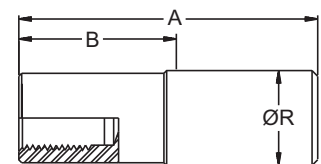

*ProLance® Fitting

Part Number	Connection Type Thread Size	A Overall Length		B Cutoff Allowance		R Diameter		Maximum Working Pressure	
		inch	mm	inch	mm	inch	mm	psi	MPa
#									
6HYPL-1-2 *	#12 - 28	1.13	29	0.53	13	0.38	10	15,000	103.4

*ProLance® fitting

2240D-025 **polyflex** Hose

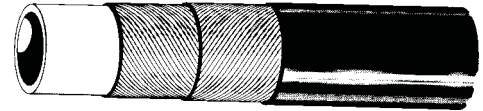

Part Number	Jacket Color	Minimum I.D.		Maximum O.D.		Maximum Working Pressure with 2.5:1		Maximum Working Pressure with 4:1		Minimum Burst Pressure		Minimum Bend Radius		Weight	
		inch	mm	inch	mm	psi	MPa	psi	MPa	psi	MPa	inch	mm	lbs/ft	kg/m
#															
2240D-025V34	Red	0.17	4	0.30	8	17,400	120.0	10,875	75.0	43,500	300.0	2.95	75	0.067	0.10

Construction: Polyoxymethylene core tube, high strength wire reinforced and a polyamide cover.

Temperature Range: -40°F and +140°F (-40°C and +60°C). Contact for temperatures outside this range.

Typical Applications: Small diameter flexible hose, ideal for tight routing applications such as high pressure heat exchanger tube cleaning in petrochemical and power plants.

National Pipe Tapered (NPT) Male Fitting 01

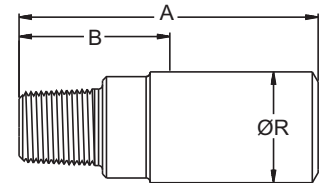

*ProLance® Fitting



Part Number	Connection Type Thread Size	A Overall Length		B Cutoff Allowance		R Diameter		Maximum Working Pressure	
		inch	mm	inch	mm	inch	mm	psi	MPa
#									
601AX-1-2A *	1/16" NPT	1.20	30	0.57	14	0.44	11	15,000	103.4
601AX-2-2A *	1/8" NPT	1.10	28	0.47	12	0.44	11	15,000	103.4

*ProLance® Fitting

National Pipe Tapered (NPT) Female Fitting

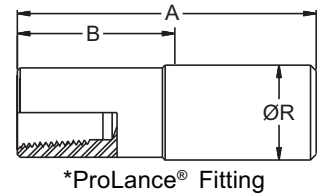
02



Part Number	Connection Type Thread Size	A Overall Length		B Cutoff Allowance		R Diameter		Maximum Working Pressure	
		inch	mm	inch	mm	inch	mm	psi	MPa
#									
602AX-1-2A *	1/16" NPT	1.50	38	0.86	22	0.44	11	15,000	103.4



*ProLance® Fitting

B

Type "M" Female Swivel Fitting

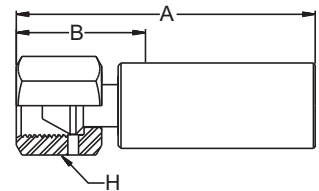
AY

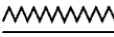



Part Number	Connection Type Thread Size	A Overall Length		B Cutoff Allowance		H Hex Size		Maximum Working Pressure	
		inch	mm	inch	mm	inch	mm	psi	MPa
#									
6AYAX-6-2A	9/16" - 18	1.52	39	0.86	22	0.75	19	17,400	120.0

JIC Female Swivel Fitting

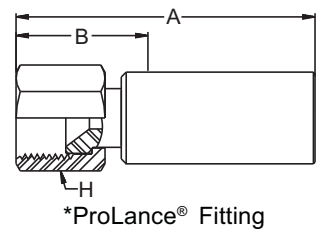
06

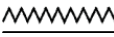

Part Number	Connection Type Thread Size	A Overall Length		B Cutoff Allowance		H Hex Size		Maximum Working Pressure	
		inch	mm	inch	mm	inch	mm	psi	MPa
#									
606AX-4-2A *	7/16" - 20	1.53	39	0.88	22	0.63	16	10,000	69.0

*ProLance® Fitting

Male Water Blast Nozzle Fitting

3Z and ZE

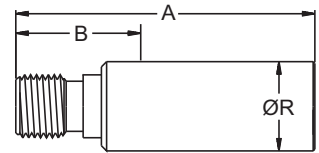

*ProLance[®] Fitting

Part Number	Connection Type Thread Size	A Overall Length		B Cutoff Allowance		R Diameter		Maximum Working Pressure	
		inch	mm	inch	mm	inch	mm	psi	MPa
#									
63ZAX-5-2A *	5/16" - 32	1.10	28	0.44	11	0.44	11	15,000	103.4
6ZEAX-5-2A *	5/16" - 24	1.31	33	0.69	18	0.44	11	15,000	103.4

*ProLance[®] Fitting

Female Water Jetting Nozzle Fitting

EZ

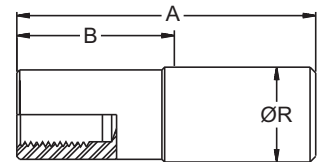

*ProLance[®] Fitting

Part Number	Connection Type Thread Size	A Overall Length		B Cutoff Allowance		R Diameter		Maximum Working Pressure	
		inch	mm	inch	mm	inch	mm	psi	MPa
#									
6EZAX-5-2A *	5/16" - 24	1.50	38	0.90	23	0.44	11	15,000	103.4
6EZAX-1-2A *	#12 - 28	1.28	33	0.66	17	0.44	11	15,000	103.4

*ProLance[®] Fitting

2240D-03 **polyflex** Hose

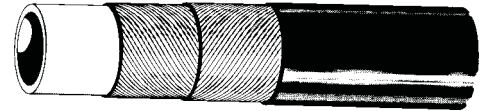

Part Number	Jacket Color	Minimum I.D.		Maximum O.D.		Maximum Working Pressure with 2.5:1		Maximum Working Pressure with 4:1		Minimum Burst Pressure		Minimum Bend Radius		Weight		
		inch	mm	inch	mm	psi	MPa	psi	MPa	psi	MPa	inch	mm	lbs/ft	kg/m	
#																
2240D-03V34	Red	0.20	5	0.38	10	16,230	111.9	10,145	70.0	40,580	279.9	3.75	95	0.134	0.20	

B

Construction: Polyoxymethylene core tube, high strength wire reinforced and a polyamide cover.

Temperature Range: -40°F and +140°F (-40°C and +60°C). Contact **polyflex** for temperatures outside this range.

Typical Applications: Small diameter flexible hose, ideal for tight routing applications such as high pressure heat exchanger tube cleaning in petrochemical and power plants.

National Pipe Tapered (NPT) Male Fitting

01

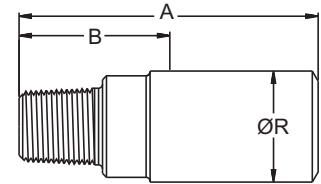
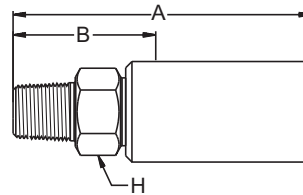

*ProLance® Fitting

Part Number	Connection Type Thread Size	A Overall Length		B Cutoff Allowance		H Hex Size/ R Diameter		Maximum Working Pressure	
		inch	mm	inch	mm	inch	mm	psi	MPa
#									
601AX-2-3 *	1/8" NPT	1.28	33	0.50	13	0.52	13	15,000	103.4
601LX-4-3	1/4" NPT	2.86	73	1.30	33	0.56	14	15,000	103.4

*ProLance® Fitting

National Pipe Tapered (NPT) Female Fitting

02

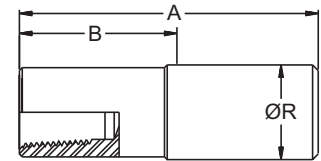

*ProLance® Fitting

Part Number	Connection Type Thread Size	A Overall Length		B Cutoff Allowance		R Diameter		Maximum Working Pressure	
		inch	mm	inch	mm	inch	mm	psi	MPa
#									
602AX-2-3 *	1/8" NPT	1.64	42	0.84	21	0.52	13	15,000	103.4

*ProLance® Fitting

Type “M” Female Swivel Fitting AY

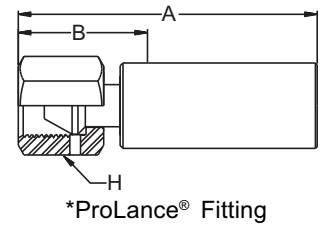

Part Number	Connection Type Thread Size	A Overall Length		B Cutoff Allowance		H Hex Size		Maximum Working Pressure	
		inch	mm	inch	mm	inch	mm	psi	MPa
#									
6AYAX-6-3 *	9/16" - 18	1.77	45	0.94	24	0.75	19	16,230	111.9
6AYLX-6-3	9/16" - 18	2.80	71	1.28	33	0.75	19	16,230	111.9

*ProLance® Fitting

JIC Female Swivel Fitting 06

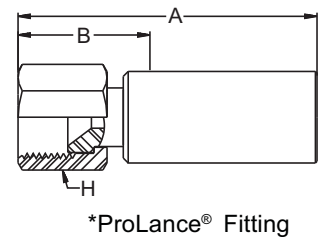

Part Number	Connection Type Thread Size	A Overall Length		B Cutoff Allowance		H Hex Size		Maximum Working Pressure	
		inch	mm	inch	mm	inch	mm	psi	MPa
#									
606AX-4-3C *	7/16" - 20	1.84	47	0.86	22	0.56	14	10,000	69.0

*ProLance® Fitting

Male Water Jetting Nozzle Fitting 3Z

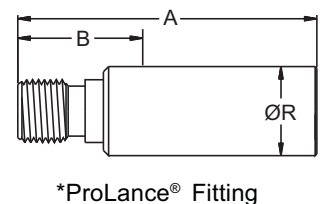

Part Number	Connection Type Thread Size	A Overall Length		B Cutoff Allowance		R Diameter		Maximum Working Pressure	
		inch	mm	inch	mm	inch	mm	psi	MPa
#									
63ZAX-5-3 *	5/16" - 32	1.31	33	0.50	13	0.52	13	15,000	103.4
63ZAX-5-3C	5/16" - 32	1.35	34	0.37	9	0.56	14	15,000	103.4

*ProLance® Fitting

2240D-04 **polyflex** Hose

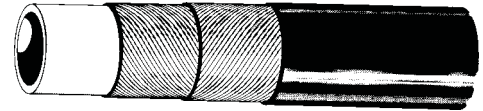

Part Number	Jacket Color	Minimum I.D.		Maximum O.D.		Maximum Working Pressure with 2.5:1		Maximum Working Pressure with 4:1		Minimum Burst Pressure		Minimum Bend Radius		Weight	
		inch	mm	inch	mm	psi	MPa	psi	MPa	psi	MPa	inch	mm	lbs/ft	kg/m
#															
2240D-04V32	Blue	0.25	6	0.45	11	14,490	99.9	9,050	62.4	36,230	249.9	4.33	110	0.175	0.26

B

Construction: Polyoxymethylene core tube, high strength wire reinforced and a polyamide cover.

Temperature Range: -40°F and +140°F (-40°C and +60°C). Contact **polyflex** for temperatures outside this range.

Typical Applications: Small diameter flexible hose, ideal for tight routing applications such as high pressure heat exchanger tube cleaning in petrochemical and power plants.

National Pipe Tapered (NPT) Male Fitting

01

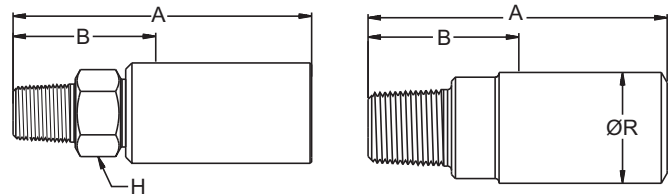

*ProLance® Fitting

Part Number	Connection Type Thread Size	A Overall Length		B Cutoff Allowance		H Hex Size/ R Diameter		Maximum Working Pressure	
		inch	mm	inch	mm	inch	mm	psi	MPa
#									
101NX-4-4	1/4" NPT	2.57	65	1.35	34	0.63	16	14,490	99.9
101NX-6-4	3/8" NPT	2.63	67	1.38	35	0.75	19	14,490	99.9
601NX-2-4 *	1/8" NPT	1.44	37	0.50	13	0.62	16	14,490	99.9
601NX-4-4 *	1/4" NPT	1.56	40	0.63	16	0.62	16	14,490	99.9
601NX-4-4C	1/4" NPT	2.38	60	1.12	28	0.63	16	14,490	99.9

*ProLance® Fitting

National Pipe Tapered (NPT) Female Fitting

02

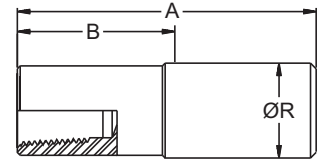

*ProLance® Fitting

Part Number	Connection Type Thread Size	A Overall Length		B Cutoff Allowance		R Diameter		Maximum Working Pressure	
		inch	mm	inch	mm	inch	mm	psi	MPa
#									
602NX-4-4 *	1/4" NPT	2.38	60	1.12	28	0.63	16	14,490	99.9

*ProLance® Fitting

Type "M" Female Swivel Fitting

AY

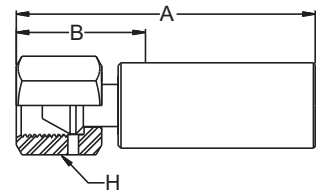

Part Number	Connection Type Thread Size	A Overall Length		B Cutoff Allowance		H Hex Size		Maximum Working Pressure	
		inch	mm	inch	mm	inch	mm	psi	MPa
#									
6AYNX-6-4	9/16" - 18	2.56	65	1.32	34	0.75	19	14,490	99.9
6AYNX-6-4C	9/16" - 18	2.36	60	1.11	28	0.68	17	14,490	99.9

JIC Female Swivel Fitting

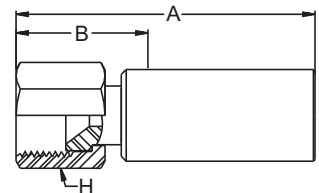

06

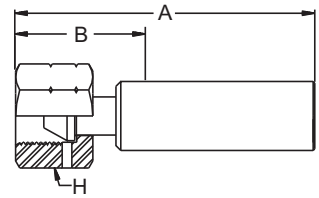

Part Number	Connection Type Thread Size	A Overall Length		B Cutoff Allowance		H Hex Size		Maximum Working Pressure	
		inch	mm	inch	mm	inch	mm	psi	MPa
#									
106NX-4-4	7/16" - 20	2.56	65	1.37	35	0.75	19	10,000	69.0
106NX-6-4	9/16" - 18	2.56	65	1.32	34	0.75	19	10,000	69.0
606NX-4-4C	7/16" - 20	2.23	57	0.99	25	0.63	16	10,000	69.0
606NX-6-4C	9/16" - 18	2.36	60	1.11	28	0.68	17	10,000	69.0

BSP Female Swivel Fitting BC





Part Number	Connection Type Thread Size	A Overall Length		B Cutoff Allowance		H Hex Size		Maximum Working Pressure	
		inch	mm	inch	mm	inch	mm	psi	MPa
#									
1BCNX-4-4	1/4" BSPP	2.50	64	1.25	32	0.75	19	14,490	99.9

B

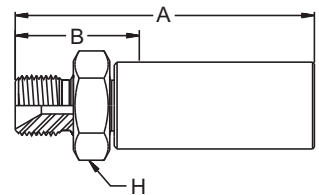
BSP Male Fitting D9



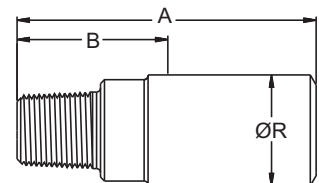

Part Number	Connection Type Thread Size	A Overall Length		B Cutoff Allowance		H Hex Size		Maximum Working Pressure	
		inch	mm	inch	mm	inch	mm	psi	MPa
#									
1D9NX-4-4	1/4" BSPP	2.64	67	1.40	36	0.75	19	14,490	99.9

Male Water Jetting Nozzle Fitting 3Z



*ProLance[®] Fitting

Part Number	Connection Type Thread Size	A Overall Length		B Cutoff Allowance		R Diameter		Maximum Working Pressure	
		inch	mm	inch	mm	inch	mm	psi	MPa
#									
63ZNX-5-4C *	5/16" - 32	2.79	71	0.45	11	0.67	17	14,490	99.9

*ProLance[®] Fitting

2240D-05 **polyflex** Hose

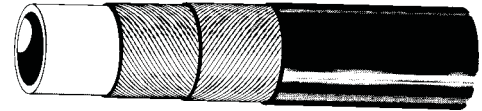

Part Number	Jacket Color	Minimum I.D.		Maximum O.D.		Maximum Working Pressure with 2.5:1		Maximum Working Pressure with 4:1		Minimum Burst Pressure		Minimum Bend Radius		Weight	
		inch	mm	inch	mm	psi	MPa	psi	MPa	psi	MPa	inch	mm	lbs/ft	kg/m
#															
2240D-05V32	Blue	0.32	8	0.52	13	13,040	89.9	8,150	56.2	32,610	224.9	4.72	120	0.17	0.25

Construction: Polyoxymethylene core tube, high strength wire reinforced and a polyamide cover.

Temperature Range: -40°F and +140°F (-40°C and +60°C). Contact **polyflex** for temperatures outside this range.

Typical Applications: High flow, flexible hose, ideal for high pressure heat exchanger tube cleaning in petrochemical and power plants.

National Pipe Tapered (NPT) Male Fitting 01

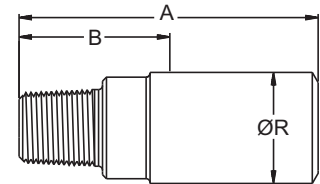

*ProLance® Fitting

Part Number	Connection Type Thread Size	A Overall Length		B Cutoff Allowance		H Hex Size/ R Diameter		Maximum Working Pressure	
		inch	mm	inch	mm	inch	mm	psi	MPa
#									
601AX-6-5 *	3/8" NPT	1.70	43	1.02	26	0.69	18	13,040	89.9

*ProLance® Fitting

2243D-025 **polyflex** Hose

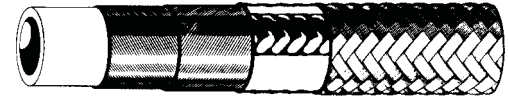

Part Number	Jacket Color	Minimum I.D.		Maximum O.D.		Maximum Working Pressure with 2.5:1		Maximum Working Pressure with 4:1		Minimum Burst Pressure		Minimum Bend Radius		Weight	
		inch	mm	inch	mm	psi	MPa	psi	MPa	psi	MPa	inch	mm	lbs/ft	kg/m
#															
2243D-025V70	SS Braid	0.17	4	0.36	9	16,240	112.0	10,150	70.0	40,600	280.0	4.00	102	0.15	0.22

Construction: Polyoxymethylene core tube, high strength wire reinforced and a polyamide cover with a stainless steel outer braid.

Temperature Range: -40°F and +140°F (-40°C and +60°C). Contact **polyflex** for temperatures outside this range.

Typical Applications: Small diameter flexible hose, ideal for tight routing applications such as high pressure heat exchanger tube cleaning in petrochemical and power plants. Stainless steel outer braid improves abrasion and cut resistance.

National Pipe Tapered (NPT) Male Fitting 01

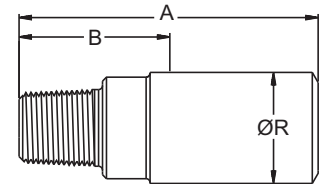

*ProLance® Fitting

Part Number	Connection Type Thread Size	A Overall Length		B Cutoff Allowance		R Diameter		Maximum Working Pressure	
		inch	mm	inch	mm	inch	mm	psi	MPa
#									
601VX-2-2A *	1/8" NPT	1.10	28	0.44	11	0.47	12	15,000	103.4

*ProLance® Fitting

B

2243D-03 **polyflex** Hose

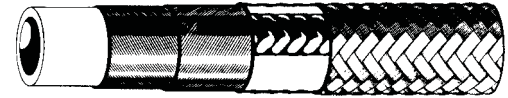

Part Number	Jacket Color	Minimum I.D.		Maximum O.D.		Maximum Working Pressure with 2.5:1		Maximum Working Pressure with 4:1		Minimum Burst Pressure		Minimum Bend Radius		Weight	
		inch	mm	inch	mm	psi	MPa	psi	MPa	psi	MPa	inch	mm	lbs/ft	kg/m
#															
2243D-03V70	SS Braid	0.20	5	0.42	11	16,240	112.0	10,150	70.0	40,600	280.0	4.50	114	0.14	0.21

Construction: Polyoxymethylene core tube, high strength wire reinforced and a polyamide cover with a stainless steel outer braid.

Temperature Range: -40°F and +140°F (-40°C and +60°C). Contact **polyflex** for temperatures outside this range.

Typical Applications: Small diameter flexible hose, ideal for tight routing applications such as high pressure heat exchanger tube cleaning in petrochemical and power plants. Stainless steel outer braid improves abrasion and cut resistance.

National Pipe Tapered (NPT) Male Fitting

01

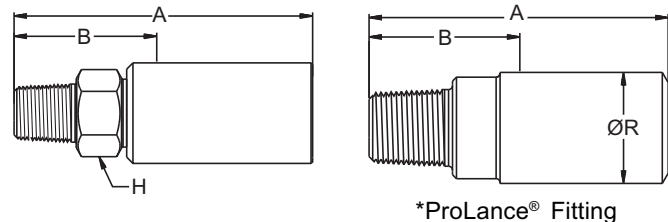

Part Number	Connection Type Thread Size	A Overall Length		B Cutoff Allowance		H Hex Size/ R Diameter		Maximum Working Pressure	
		inch	mm	inch	mm	inch	mm	psi	MPa
#									
601AX-2-3 *	1/8" NPT	1.28	33	0.50	13	0.52	13	15,000	103.4
601LX-4-3	1/4" NPT	2.86	73	1.30	33	0.56	14	15,000	103.4



*ProLance® Fitting

National Pipe Tapered (NPT) Female Fitting

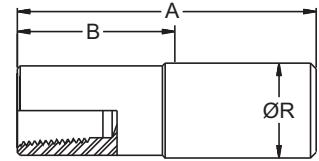
02



*ProLance® Fitting

Part Number	Connection Type Thread Size	A Overall Length		B Cutoff Allowance		R Diameter		Maximum Working Pressure	
		inch	mm	inch	mm	inch	mm	psi	MPa
#									
602AX-2-3 *	1/8" NPT	1.64	42	0.84	21	0.52	13	15,000	103.4

*ProLance® Fitting



B

Type "M" Female Swivel Fitting

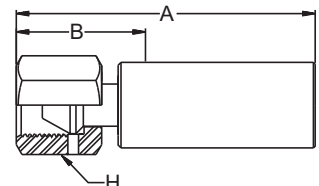
AY



*ProLance® Fitting



Part Number	Connection Type Thread Size	A Overall Length		B Cutoff Allowance		H Hex Size		Maximum Working Pressure	
		inch	mm	inch	mm	inch	mm	psi	MPa
#									
6AYAX-6-3 *	9/16" - 18	1.77	45	0.94	24	0.75	19	16,240	112.0
6AYLX-6-3	9/16" - 18	2.80	71	1.28	33	0.75	19	16,240	112.0

*ProLance® Fitting

JIC Female Swivel Fitting

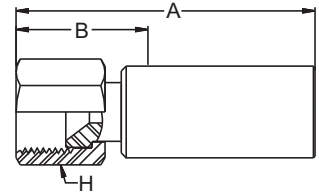
06

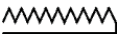

Part Number	Connection Type Thread Size	A Overall Length		B Cutoff Allowance		H Hex Size		Maximum Working Pressure	
		inch	mm	inch	mm	inch	mm	psi	MPa
#									
606AX-4-3C *	7/16" - 20	1.84	47	0.86	22	0.56	14	10,000	69.0



*ProLance[®] fitting

Male Water Jetting Nozzle Fitting

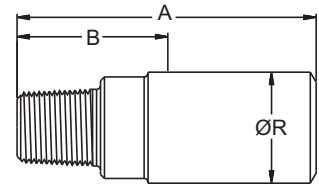
3Z

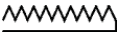

*ProLance[®] Fitting

Part Number	Connection Type Thread Size	A Overall Length		B Cutoff Allowance		R Diameter		Maximum Working Pressure	
		inch	mm	inch	mm	inch	mm	psi	MPa
#									
63ZAX-5-3 *	5/16" - 32	1.31	33	0.50	13	0.52	13	15,000	103.4
63ZAX-5-3C	5/16" - 32	1.35	34	0.37	9	0.56	14	15,000	103.4

*ProLance[®] Fitting

2243D-04 **polyflex** Hose

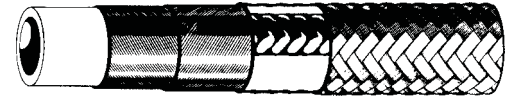

Part Number	Jacket Color	Minimum I.D.		Maximum O.D.		Maximum Working Pressure with 2.5:1		Maximum Working Pressure with 4:1		Minimum Burst Pressure		Minimum Bend Radius		Weight	
		inch	mm	inch	mm	psi	MPa	psi	MPa	psi	MPa	inch	mm	lbs/ft	kg/m
#															
2243D-04V70	SS Braid	0.25	6	0.50	13	14,000	96.6	8,750	60.3	35,000	241.4	5.00	127	0.20	0.30

Construction: Polyoxymethylene core tube, high strength wire reinforced and a polyamide cover with a stainless steel outer braid.

Temperature Range: -40°F and +140°F (-40°C and +60°C). Contact **polyflex** for temperatures outside this range.

Typical Applications: Small diameter flexible hose, ideal for tight routing applications such as high pressure heat exchanger tube cleaning in petrochemical and power plants. Stainless steel outer braid improves abrasion and cut resistance.

B

National Pipe Tapered (NPT) Male Fitting

01

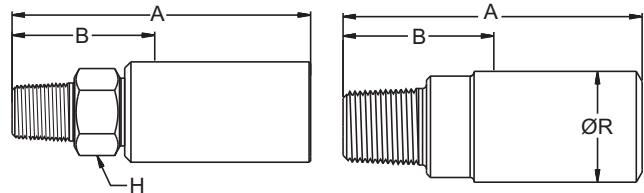

*ProLance® Fitting

Part Number	Connection Type Thread Size	A Overall Length		B Cutoff Allowance		H Hex Size/ R Diameter		Maximum Working Pressure	
		inch	mm	inch	mm	inch	mm	psi	MPa
#									
101NX-4-4	1/4" NPT	2.57	65	1.35	34	0.63	16	14,000	96.6
101NX-6-4	3/8" NPT	2.63	67	1.38	35	0.75	19	14,000	96.6
601NX-2-4 *	1/8" NPT	1.44	37	0.50	13	0.62	16	14,000	96.6
601NX-4-4 *	1/4" NPT	1.56	40	0.63	16	0.62	16	14,000	96.6
601NX-4-4C	1/4" NPT	2.38	60	1.12	28	0.63	16	14,000	96.6

*ProLance® Fitting

National Pipe Tapered (NPT) Female Fitting 02

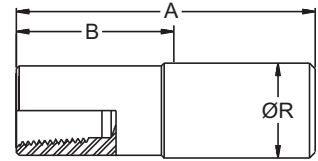

*ProLance® Fitting

Part Number	Connection Type Thread Size	A Overall Length		B Cutoff Allowance		R Diameter		Maximum Working Pressure	
		inch	mm	inch	mm	inch	mm	psi	MPa
#									
602NX-4-4 *	1/4" NPT	1.89	48	0.95	24	0.75	19	10,000	69.0

*ProLance® Fitting

Type "M" Female Swivel Fitting AY

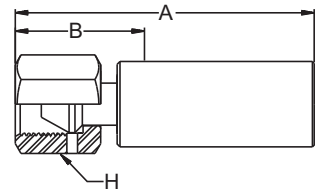

Part Number	Connection Type Thread Size	A Overall Length		B Cutoff Allowance		H Hex Size		Maximum Working Pressure	
		inch	mm	inch	mm	inch	mm	psi	MPa
#									
6AYNX-6-4C	9/16" - 18	2.36	60	1.11	28	0.68	17	14,000	96.6
6AYNX-6-4	9/16" - 18	2.56	65	1.32	34	0.75	19	14,000	96.6

JIC Female Swivel Fitting 06

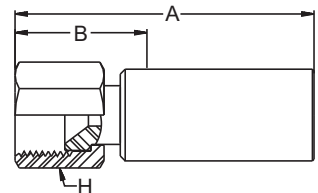

Part Number	Connection Type Thread Size	A Overall Length		B Cutoff Allowance		H Hex Size		Maximum Working Pressure	
		inch	mm	inch	mm	inch	mm	psi	MPa
#									
106NX-4-4	7/16" - 20	2.56	65	1.37	35	0.75	19	10,000	69.0
106NX-6-4	9/16" - 18	2.56	65	1.32	34	0.75	19	10,000	69.0
606NX-4-4C	7/16" - 20	2.23	57	0.99	25	0.63	16	10,000	69.0
606NX-6-4C	9/16" - 18	2.36	60	1.11	28	0.68	17	10,000	69.0

BSP Female Swivel Fitting BC

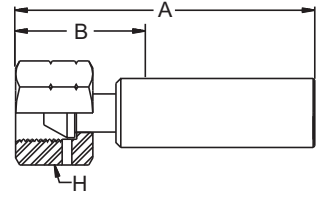

Part Number	Connection Type Thread Size	A Overall Length		B Cutoff Allowance		H Hex Size		Maximum Working Pressure	
		inch	mm	inch	mm	inch	mm	psi	MPa
#									
1BCLX-4-4	1/4" BSPP	2.50	64	1.25	32	0.75	19	14,000	96.6

B

BSP Male Fitting D9

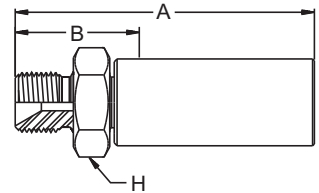

Part Number	Connection Type Thread Size	A Overall Length		B Cutoff Allowance		H Hex Size		Maximum Working Pressure	
		inch	mm	inch	mm	inch	mm	psi	MPa
#									
1D9LX-4-4	1/4" BSPP	2.64	67	1.40	36	0.75	19	14,000	96.6

Male Water Jetting Nozzle Fitting 3Z

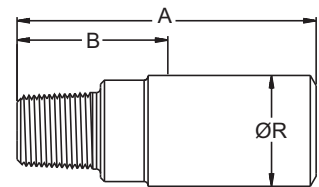

*ProLance® Fitting

Part Number	Connection Type Thread Size	A Overall Length		B Cutoff Allowance		R Diameter		Maximum Working Pressure	
		inch	mm	inch	mm	inch	mm	psi	MPa
#									
63ZNX-5-4C	5/16" - 32	2.79	71	0.45	11	0.67	17	14,000	96.6

*ProLance® Fitting

2244N-025 **polyflex** Hose

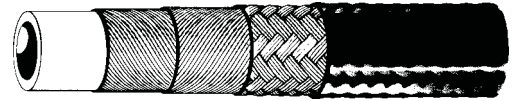

Part Number	Jacket Color	Minimum I.D.		Maximum O.D.		Maximum Working Pressure with 2.5:1		Maximum Working Pressure with 4:1		Minimum Burst Pressure		Minimum Bend Radius		Weight	
		inch	mm	inch	mm	psi	MPa	psi	MPa	psi	MPa	inch	mm	lbs/ft	kg/m
#															
2244N-025V00	Black	0.17	4	0.38	10	17,400	120.0	10,870	75.0	43,500	300.0	2.17	55	0.13	0.19

Construction: Polyamide core tube, high strength wire reinforced and a polyurethane outer cover.

Temperature Range: -40°F and +140°F (-40°C and +60°C). Contact **polyflex** for temperatures outside this range.

Typical Applications: Small diameter, low volumetric expansion hose. Ideal for pressure testing, portable hydraulic tools that require extreme kink resistance and maximum flexibility. Available in long single lengths and in Twin-Line construction.

National Pipe Tapered (NPT) Male Fitting 01

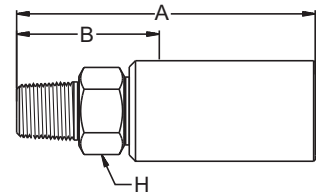

Part Number	Connection Type Thread Size	A Overall Length		B Cutoff Allowance		H Hex Size		Maximum Working Pressure	
		inch	mm	inch	mm	inch	mm	psi	MPa
#									
6018X-2-2A	1/8" NPT	1.86	47	0.76	19	0.63	16	15,000	103.4
6018X-2-2AC	1/8" NPT	2.18	55	1.80	46	0.50	13	15,000	103.4
6018X-4-2AC	1/4" NPT	2.44	62	1.35	34	0.62	16	15,000	103.4

Type "M" Female Swivel Fitting AY

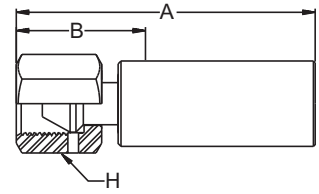

Part Number	Connection Type Thread Size	A Overall Length		B Cutoff Allowance		H Hex Size		Maximum Working Pressure	
		inch	mm	inch	mm	inch	mm	psi	MPa
#									
1AY8X-6-2A	9/16" - 18	2.19	56	1.12	28	0.75	19	10,870	75.0
6AY8X-6-2AC	9/16" - 18	2.32	59	1.24	31	0.68	17	17,400	120.0

B

JIC Female Swivel Fitting 06

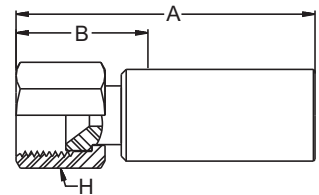

Part Number	Connection Type Thread Size	A Overall Length		B Cutoff Allowance		H Hex Size		Maximum Working Pressure	
		inch	mm	inch	mm	inch	mm	psi	MPa
#									
6068X-4-2AC	7/16" - 20	2.17	55	1.05	27	0.56	14	10,000	69.0

2244N-08 **polyflex** Hose

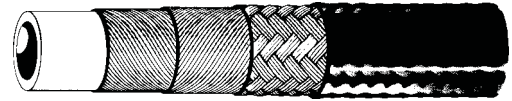

Part Number	Jacket Color	Minimum I.D.		Maximum O.D.		Maximum Working Pressure with 2.5:1		Maximum Working Pressure with 4:1		Minimum Burst Pressure		Minimum Bend Radius		Weight		
		inch	mm	inch	mm	psi	MPa	psi	MPa	psi	MPa	inch	mm	lbs/ft	kg/m	
#																
2244N-08V10	Black	0.50	13	0.89	23	12,760	88.0	7,970	55.0	31,900	220.0	5.90	150	0.54	0.80	
2244N-08V71	Black	0.50	13	0.89	23	12,760	88.0	7,970	55.0	31,900	220.0	5.90	150	0.54	0.80	

Construction: Polyamide core tube, high strength wire reinforced and a polyurethane outer cover.

Temperature Range: -40°F and +140°F (-40°C and +60°C). Contact **polyflex** for temperatures outside this range.

Typical Applications: Flexible, lightweight, chemical resistant alternative to steel pipe and rubber hose for applications such as waterblasting, gas transfer, chemical injection, wireline logging services, and pressure testing. The -08V71 is typically used in Methanol injection applications.

National Pipe Tapered (NPT) Male Fitting 01

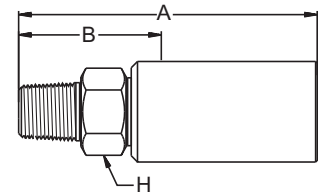

Part Number	Connection Type Thread Size	A Overall Length		B Cutoff Allowance		H Hex Size		Maximum Working Pressure	
		inch	mm	inch	mm	inch	mm	psi	MPa
#									
6018X-8-8C	1/2" NPT	3.46	88	1.67	42	1.00	25	12,760	88.0
601LX-8-8	1/2" NPT	3.75	95	1.68	43	1.25	32	12,760	88.0

BSPP Male ProLance Fitting

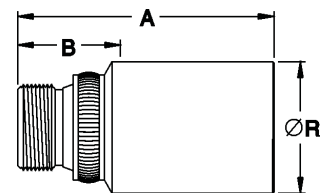

*ProLance® Fitting

Part Number	Connection Type Thread Size	A Overall Length		B Cutoff Allowance		R Diameter		Maximum Working Pressure	
		inch	mm	inch	mm	inch	mm	psi	MPa
#									
6D9NX-8-8-PL *	1/2" BSPP	2.50	64	1.00	25	1.26	32	10,000	69.0

*ProLance® Fitting

Type “M” Female Swivel Fitting AY

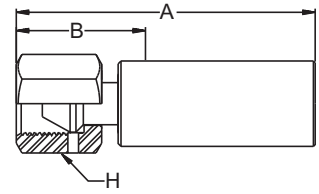

Part Number	Connection Type Thread Size	A Overall Length		B Cutoff Allowance		H Hex Size		Maximum Working Pressure	
		inch	mm	inch	mm	inch	mm	psi	MPa
#									
6AY8X-11-8C	1" - 12	3.27	83	1.49	38	1.25	32	12,760	88.0
6AYLX-11-8C	1" - 12	3.53	90	1.50	38	1.25	32	12,760	88.0
6AYLX-11-8C-SD *	1" - 12	3.53	90	1.50	38	1.25	32	12,760	88.0

*SD – Corrosion resistant (sea water)

B

JIC Female Swivel Fitting 06

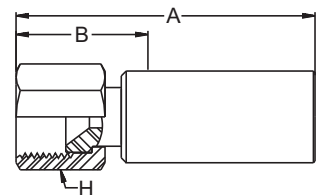

Part Number	Connection Type Thread Size	A Overall Length		B Cutoff Allowance		H Hex Size		Maximum Working Pressure	
		inch	mm	inch	mm	inch	mm	psi	MPa
#									
6068X-8-8C	3/4" - 16	3.10	79	1.30	33	0.87	22	10,000	69.0

Metric Female Swivel Fitting C9

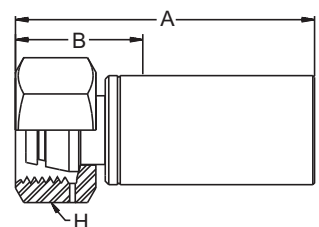

Part Number	Connection Type Thread Size	A Overall Length		B Cutoff Allowance		H Hex Size		Maximum Working Pressure	
		inch	mm	inch	mm	inch	mm	psi	MPa
#									
6C9LX-16-8C	M24 x 1.5	3.48	88	1.44	37	1.26	32	12,760	88.0

2244N-20 **polyflex** Hose

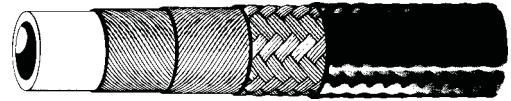

Part Number	Jacket Color	Minimum I.D.		Maximum O.D.		Maximum Working Pressure with 2.5:1		Maximum Working Pressure with 4:1		Minimum Burst Pressure		Minimum Bend Radius		Weight	
		inch	mm	inch	mm	psi	MPa	psi	MPa	psi	MPa	inch	mm	lbs/ft	kg/m
#															
2244N-20V30	Black	1.25	32	1.73	44	6,380	44.0	3,990	27.5	15,950	110.0	15.75	400	1.23	1.83

Construction: Polyamide core tube, high strength wire reinforced and a polyamide outer cover.

Temperature Range: -40°F and +140°F (-40°C and +60°C). Contact **polyflex** for temperatures outside this range.

Typical Applications: Lightweight, chemical resistant hose used to replace steel pipe and rubber hose for hydraulic test systems using Skydrol fluids and gas transfer services.

JIC Female Swivel Fitting

06

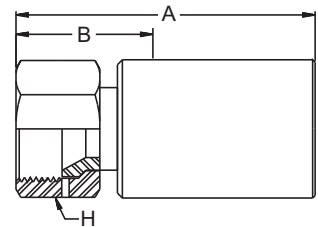

Part Number	Connection Type Thread Size	A Overall Length		B Cutoff Allowance		H Hex Size		Maximum Working Pressure	
		inch	mm	inch	mm	inch	mm	psi	MPa
#									
106NX-20-20	1-5/8" - 12	4.10	104	1.73	44	1.97	50	6,380	44.0

2245D-03 **polyflex** Hose

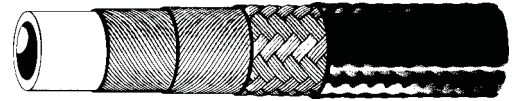

Part Number	Jacket Color	Minimum I.D.		Maximum O.D.		Maximum Working Pressure with 2.5:1		Maximum Working Pressure with 4:1		Minimum Burst Pressure		Minimum Bend Radius		Weight	
		inch	mm	inch	mm	psi	MPa	psi	MPa	psi	MPa	inch	mm	lbs/ft	kg/m
#															
2245D-03V32	Blue	0.20	5	0.42	11	16,240	112.0	10,150	70.0	40,600	280.0	3.50	89	0.13	0.19

Construction: Polyoxymethylene core tube, high strength wire reinforced and a polyamide outer cover.

Temperature Range: -40°F and +140°F (-40°C and +60°C). Contact **polyflex** for temperatures outside this range.

Typical Applications: Small diameter flexible hose, ideal for tight routing applications such as high pressure heat exchanger tube cleaning in petrochemical and power plants.

National Pipe Tapered (NPT) Male Fitting

01

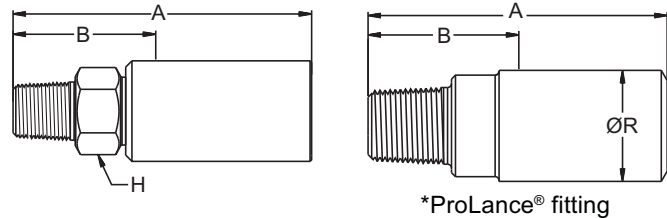

Part Number	Connection Type Thread Size	A Overall Length		B Cutoff Allowance		H Hex Size/ R Diameter		Maximum Working Pressure	
		inch	mm	inch	mm	inch	mm	psi	MPa
#									
601AX-2-3 *	1/8" NPT	1.28	33	0.50	13	0.52	13	15,000	103.4
601LX-4-3	1/4" NPT	2.86	73	1.30	33	0.56	14	15,000	103.4

*ProLance® Fitting

National Pipe Tapered (NPT) Female Fitting

02

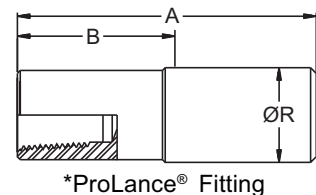

Part Number	Connection Type Thread Size	A Overall Length		B Cutoff Allowance		R Diameter		Maximum Working Pressure	
		inch	mm	inch	mm	inch	mm	psi	MPa
#									
602AX-2-3 *	1/8" NPT	1.64	42	0.84	21	0.52	13	15,000	103.4

*ProLance® Fitting

B

Type "M" Female Swivel Fitting AY

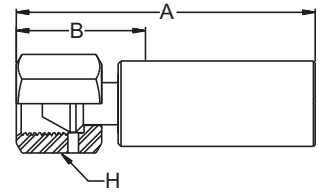

*ProLance® Fitting

Part Number	Connection Type Thread Size	A Overall Length		B Cutoff Allowance		H Hex Size		Maximum Working Pressure	
		inch	mm	inch	mm	inch	mm	psi	MPa
#									
6AYAX-6-3 *	9/16" - 18	1.77	45	0.94	24	0.75	19	16,240	112.0
6AYLX-6-3	9/16" - 18	2.80	71	1.28	33	0.75	19	16,240	112.0

*ProLance® Fitting

JIC Female Swivel Fitting 06

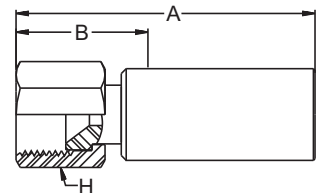

*ProLance® Fitting

Part Number	Connection Type Thread Size	A Overall Length		B Cutoff Allowance		H Hex Size		Maximum Working Pressure	
		inch	mm	inch	mm	inch	mm	psi	MPa
#									
606AX-4-3C *	7/16" - 20	1.84	47	0.86	22	0.56	14	10,000	69.0

*ProLance® Fitting

Male Water Jetting Nozzle Fitting 3Z

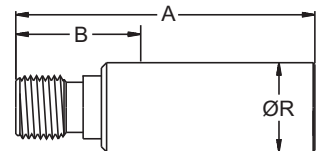

*ProLance® Fitting

Part Number	Connection Type Thread Size	A Overall Length		B Cutoff Allowance		R Diameter		Maximum Working Pressure	
		inch	mm	inch	mm	inch	mm	psi	MPa
#									
63ZAX-5-3 *	5/16" - 32	1.31	33	0.50	13	0.52	13	15,000	103.4
63ZAX-5-3C	5/16" - 32	1.35	34	0.37	9	0.56	14	15,000	103.4

*ProLance® Fitting

2245N-04 **polyflex** Hose

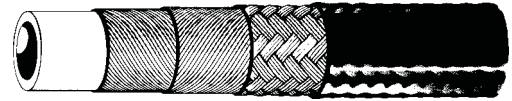

Part Number	Jacket Color	Minimum I.D.		Maximum O.D.		Maximum Working Pressure with 2.5:1		Maximum Working Pressure with 4:1		Minimum Burst Pressure		Minimum Bend Radius		Weight	
		inch	mm	inch	mm	psi	MPa	psi	MPa	psi	MPa	inch	mm	lbs/ft	kg/m
#															
2245N-04V00	Black	0.25	6	0.50	13	10,440	72.0	6,525	45.0	26,100	180.0	2.76	70	0.17	0.25
2245N-04V02	Blue	0.25	6	0.50	13	10,440	72.0	6,525	45.0	26,100	180.0	2.76	70	0.17	0.25
2245N-04V04	Red	0.25	6	0.50	13	10,440	72.0	6,525	45.0	26,100	180.0	2.76	70	0.17	0.25

B

Construction: Polyamide core tube, high strength wire reinforced and a polyurethane outer cover.

Temperature Range: -40°F and +140°F (-40°C and +60°C). Contact **polyflex** for temperatures outside this range.

Typical Applications: Small diameter, low volumetric expansion hose. Ideal for pressure testing, portable hydraulic tools and hydraulic controls.

National Pipe Tapered (NPT) Male Fitting

01

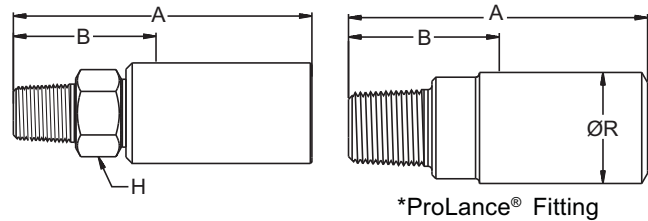

Part Number	Connection Type Thread Size	A Overall Length		B Cutoff Allowance		H Hex Size/ R Diameter		Maximum Working Pressure	
		inch	mm	inch	mm	inch	mm	psi	MPa
#									
101NX-4-4	1/4" NPT	2.57	65	1.35	34	0.63	16	10,440	72.0
101NX-6-4	3/8" NPT	2.63	67	1.38	35	0.75	19	10,440	72.0
601NX-2-4 *	1/8" NPT	1.44	37	0.50	13	0.62	16	10,440	72.0
601NX-4-4 *	1/4" NPT	1.56	40	0.63	16	0.62	16	10,440	72.0
601NX-4-4C	1/4" NPT	2.38	60	1.12	28	0.63	16	10,440	72.0

*ProLance® Fitting

National Pipe Tapered (NPT) Female Fitting 02

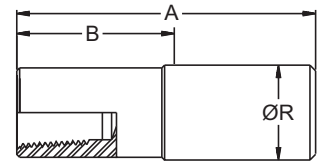

*ProLance® Fitting

Part Number	Connection Type Thread Size	A Overall Length		B Cutoff Allowance		R Diameter		Maximum Working Pressure	
		inch	mm	inch	mm	inch	mm	psi	MPa
#									
602NX-4-4 *	1/4" NPT	1.89	48	0.95	24	0.75	19	10,000	69.0

*ProLance® Fitting

Type "M" Female Swivel Fitting AY

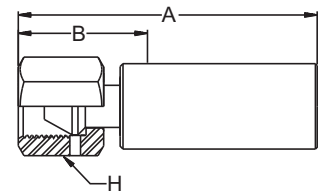

Part Number	Connection Type Thread Size	A Overall Length		B Cutoff Allowance		H Hex Size		Maximum Working Pressure	
		inch	mm	inch	mm	inch	mm	psi	MPa
#									
6AYNX-6-4	9/16" - 18	2.56	65	1.32	34	0.75	19	10,440	72.0
6AYNX-6-4C	9/16" - 18	2.36	60	1.11	28	0.68	17	10,440	72.0

JIC Female Swivel Fitting 06

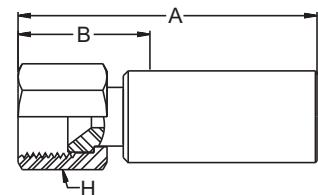

Part Number	Connection Type Thread Size	A Overall Length		B Cutoff Allowance		H Hex Size		Maximum Working Pressure	
		inch	mm	inch	mm	inch	mm	psi	MPa
#									
106NX-4-4	7/16" - 20	2.56	65	1.37	35	0.75	19	10,000	69.0
106NX-6-4	9/16" - 18	2.56	65	1.32	34	0.75	19	10,000	69.0
606NX-4-4C	7/16" - 20	2.23	57	0.99	25	0.63	16	10,000	69.0
606NX-6-4C	9/16" - 18	2.36	60	1.11	28	0.68	17	10,000	69.0

BSP Female Swivel Fitting

BC

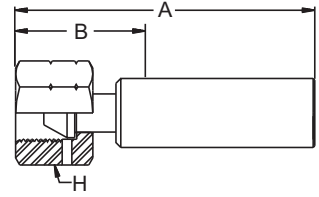

Part Number	Connection Type Thread Size	A Overall Length		B Cutoff Allowance		H Hex Size		Maximum Working Pressure	
		inch	mm	inch	mm	inch	mm	psi	MPa
#									
1BCNX-4-4	1/4" BSPP	2.50	64	1.25	32	0.75	19	10,440	72.0

B

BSP Male Fitting

D9

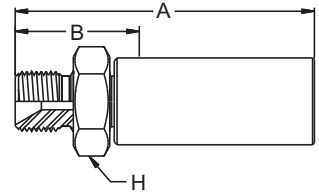

Part Number	Connection Type Thread Size	A Overall Length		B Cutoff Allowance		H Hex Size		Maximum Working Pressure	
		inch	mm	inch	mm	inch	mm	psi	MPa
#									
1D9NX-4-4	1/4" BSPP	2.64	67	1.40	36	0.75	19	10,440	72.0

Metric Female Swivel Fitting

C3

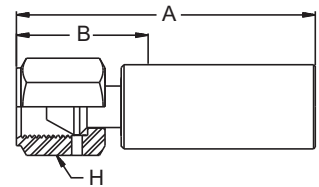



Part Number	Connection Type Thread Size	A Overall Length		B Cutoff Allowance		H Hex Size		Maximum Working Pressure	
		inch	mm	inch	mm	inch	mm	psi	MPa
#									
1C3NX-8-4	M14 x 1.5	2.45	62	1.20	30	0.75	19	10,440	72.0

Male Water Jetting Nozzle Fitting

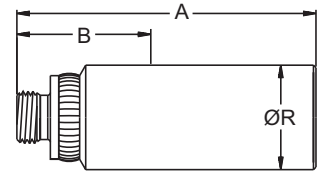
3Z



*ProLance® Fitting

Part Number	Connection Type Thread Size	A Overall Length		B Cutoff Allowance		R Diameter		Maximum Working Pressure	
		inch	mm	inch	mm	inch	mm	psi	MPa
#									
63ZNX-5-4C *	5/16" - 32	2.79	71	0.45	11	0.67	17	10,440	72.0

*ProLance® Fitting

2245N-05 **polyflex** Hose

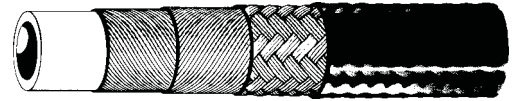

Part Number	Jacket Color	Minimum I.D.		Maximum O.D.		Maximum Working Pressure with 2.5:1		Maximum Working Pressure with 4:1		Minimum Burst Pressure		Minimum Bend Radius		Weight	
		inch	mm	inch	mm	psi	MPa	psi	MPa	psi	MPa	inch	mm	lbs/ft	kg/m
#															
2245N-05V00	Black	0.31	8	0.56	14	9,280	64.0	5,800	40.0	23,200	160.0	3.94	100	0.22	0.33

B

Construction: Polyamide core tube, high strength wire reinforced and a polyurethane outer cover.

Temperature Range: -40°F and +140°F (-40°C and +60°C). Contact **polyflex** for temperatures outside this range.

Typical Applications: Low volumetric expansion hose for use with petroleum or synthetic hydraulic fluids, and in long lengths for waterblasting, pipe cleaning and line moleing applications.

National Pipe Tapered (NPT) Male Fitting 01

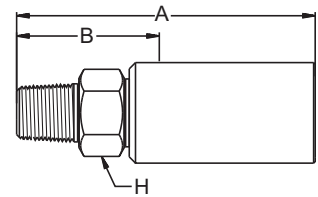

Part Number	Connection Type Thread Size	A Overall Length		B Cutoff Allowance		H Hex Size		Maximum Working Pressure	
		inch	mm	inch	mm	inch	mm	psi	MPa
#									
101NX-6-05	3/8" NPT	2.52	64	1.18	30	0.75	19	9,280	64.0

JIC Female Swivel Fitting 06

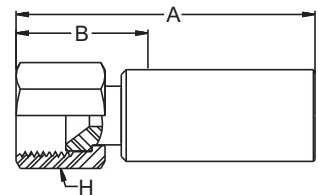

Part Number	Connection Type Thread Size	A Overall Length		B Cutoff Allowance		H Hex Size		Maximum Working Pressure	
		inch	mm	inch	mm	inch	mm	psi	MPa
#									
106NX-6-05	9/16" - 18	2.38	60	1.03	26	0.75	19	9,280	64.0

BSP Female Swivel Fitting

92

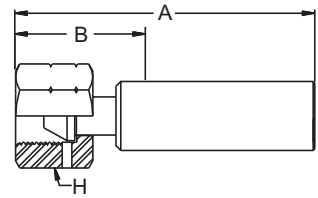

Part Number	Connection Type Thread Size	A Overall Length		B Cutoff Allowance		H Hex Size		Maximum Working Pressure	
		inch	mm	inch	mm	inch	mm	psi	MPa
#									
192NX-6-05	3/8" BSPP	2.50	64	1.21	31	0.87	22	9,280	64.0

BSP Male Fitting

3B

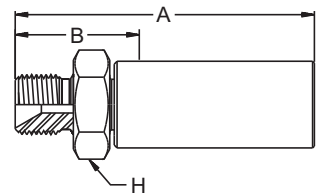

Part Number	Connection Type Thread Size	A Overall Length		B Cutoff Allowance		H Hex Size		Maximum Working Pressure	
		inch	mm	inch	mm	inch	mm	psi	MPa
#									
13BNX-6-05	3/8" BSPP	2.50	64	1.16	29	0.87	22	9,280	64.0

Metric Female Swivel Fitting

C9

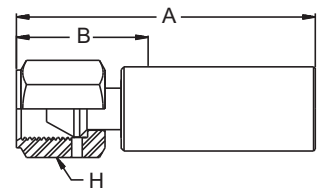

Part Number	Connection Type Thread Size	A Overall Length		B Cutoff Allowance		H Hex Size		Maximum Working Pressure	
		inch	mm	inch	mm	inch	mm	psi	MPa
#									
1C9NX-12-05	M20 x 1.5	2.48	63	1.14	29	0.95	24	9,280	64.0

2245N-06 **polyflex** Hose

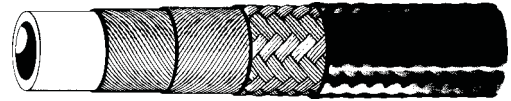

Part Number	Jacket Color	Minimum I.D.		Maximum O.D.		Maximum Working Pressure with 2.5:1		Maximum Working Pressure with 4:1		Minimum Burst Pressure		Minimum Bend Radius		Weight	
		inch	mm	inch	mm	psi	MPa	psi	MPa	psi	MPa	inch	mm	lbs/ft	kg/m
#															
2245N-06V30	Black	0.40	10	0.67	17	8,700	60.0	5,440	37.5	21,750	150.0	4.73	120	0.28	0.42

Construction: Polyamide core tube, high strength wire reinforced and a polyurethane outer cover.

Temperature Range: -40°F and +140°F (-40°C and +60°C). Contact **polyflex** for temperatures outside this range.

Typical Applications: Low volumetric expansion hose for use with petroleum or synthetic hydraulic fluids, and in long lengths for waterblasting, pipe cleaning and line moleing applications.

National Pipe Tapered (NPT) Male Fitting

01

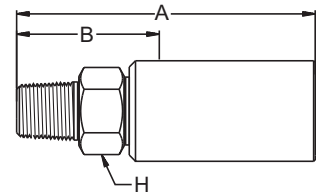

Part Number	Connection Type Thread Size	A Overall Length		B Cutoff Allowance		H Hex Size		Maximum Working Pressure	
		inch	mm	inch	mm	inch	mm	psi	MPa
#									
101NX-6-06	3/8" NPT	2.79	71	1.20	30	0.87	22	8,700	60.0
101NX-8-06	1/2" NPT	3.00	76	1.40	36	0.95	24	8,700	60.0

JIC Female Swivel Fitting

06

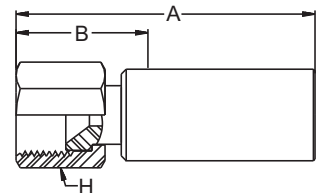

Part Number	Connection Type Thread Size	A Overall Length		B Cutoff Allowance		H Hex Size		Maximum Working Pressure	
		inch	mm	inch	mm	inch	mm	psi	MPa
#									
106NX-6-06	9/16" - 18	2.68	68	1.09	28	0.87	22	8,700	60.0
106NX-8-06	3/4" - 16	2.82	72	1.23	31	0.95	24	8,700	60.0

BSP Female Swivel Fitting

92

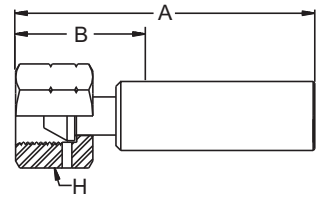

Part Number	Connection Type Thread Size	A Overall Length		B Cutoff Allowance		H Hex Size		Maximum Working Pressure	
		inch	mm	inch	mm	inch	mm	psi	MPa
#									
192NX-6-06	3/8" BSPP	2.70	69	1.11	28	0.87	22	8,700	60.0
192NX-8-06	1/2" BSPP	2.86	73	1.27	32	1.06	27	8,700	60.0

BSP Male Fitting

3B

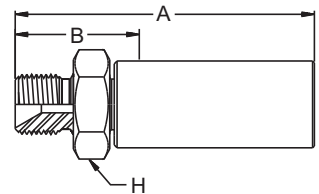

Part Number	Connection Type Thread Size	A Overall Length		B Cutoff Allowance		H Hex Size		Maximum Working Pressure	
		inch	mm	inch	mm	inch	mm	psi	MPa
#									
13BNX-6-06	3/8" BSPP	2.78	71	1.18	30	0.87	22	8,700	60.0
13BNX-8-06	1/2" BSPP	2.97	75	1.38	35	0.87	22	8,700	60.0

Metric Female Swivel Fitting

C9

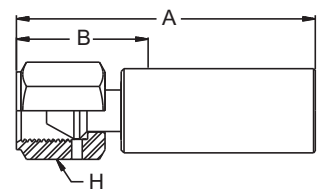

Part Number	Connection Type Thread Size	A Overall Length		B Cutoff Allowance		H Hex Size		Maximum Working Pressure	
		inch	mm	inch	mm	inch	mm	psi	MPa
#									
1C9NX-14-06	M22 x 1.5	2.78	71	0.93	24	1.062	27	8,700	60.0

2245N-08 **polyflex** Hose

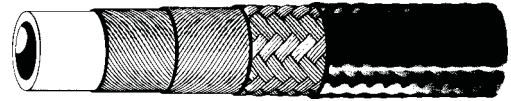

Part Number	Jacket Color	Minimum I.D.		Maximum O.D.		Maximum Working Pressure with 2.5:1		Maximum Working Pressure with 4:1		Minimum Burst Pressure		Minimum Bend Radius		Weight	
		inch	mm	inch	mm	psi	MPa	psi	MPa	psi	MPa	inch	mm	lbs/ft	kg/m
#															
2245N-08V30	Black	0.50	13	0.81	21	8,120	56.0	5,075	35.0	20,300	140.0	5.50	140	0.35	0.52

B

Construction: Polyamide core tube, high strength wire reinforced and a polyamide outer cover.

Temperature Range: -40°F and +140°F (-40°C and +60°C). Contact **polyflex** for temperatures outside this range.

Typical Applications: Lightweight, chemical resistant hose used to replace steel pipe and rubber hose for hydraulic test systems using Skydrol® fluids and gas transfer services.

National Pipe Tapered (NPT) Male Fitting 01

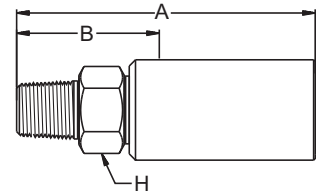



Part Number	Connection Type Thread Size	A Overall Length		B Cutoff Allowance		H Hex Size		Maximum Working Pressure	
		inch	mm	inch	mm	inch	mm	psi	MPa
#									
6019X-8-8C	1/2" NPT	3.37	86	1.68	43	1.00	25	8,120	56.0
6019X-8-8	1/2" NPT	3.35	85	1.43	36	0.87	22	8,120	56.0

*Skydrol® is a registered trademark of Solutia, Inc.

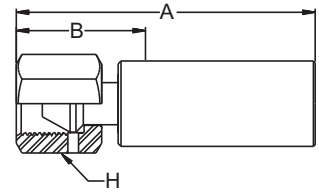

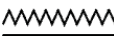
Type "M" Female Swivel Fitting AY

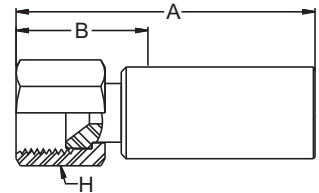

Part Number	Connection Type Thread Size	A Overall Length		B Cutoff Allowance		H Hex Size		Maximum Working Pressure	
		inch	mm	inch	mm	inch	mm	psi	MPa
#									
6AY9X-11-8C	1" - 12	3.20	81	1.50	38	1.25	32	8,120	56.0

JIC Female Swivel Fitting 06



Part Number	Connection Type Thread Size	A Overall Length		B Cutoff Allowance		H Hex Size		Maximum Working Pressure	
		inch	mm	inch	mm	inch	mm	psi	MPa
#									
6069X-8-8C	3/4" - 16	3.00	76	1.30	33	0.87	22	8,120	56.0

2245N-12 **polyflex** Hose

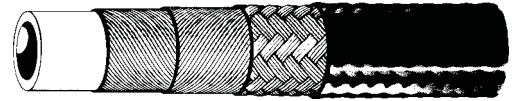

Part Number	Jacket Color	Minimum I.D.		Maximum O.D.		Maximum Working Pressure with 2.5:1		Maximum Working Pressure with 4:1		Minimum Burst Pressure		Minimum Bend Radius		Weight	
		inch	mm	inch	mm	psi	MPa	psi	MPa	psi	MPa	inch	mm	lbs/ft	kg/m
#															
2245N-12V30	Black	0.75	19	1.13	29	6,960	48.0	4,350	30.0	17,400	120.0	9.45	240	0.62	0.92

B

Construction: Polyamide core tube, high strength wire reinforced and a polyamide outer cover.

Temperature Range: -40°F and +140°F (-40°C and +60°C). Contact **polyflex** for temperatures outside this range.

Typical Applications: Lightweight, chemical resistant hose used to replace steel pipe and rubber hose for hydraulic test systems using synthetic and phosphate ester fluids, such as Skydrol®* fluids and gas transfer service.

National Pipe Tapered (NPT) Male Fitting 01

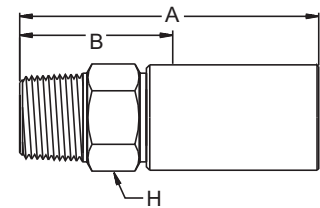





Part Number	Connection Type Thread Size	A Overall Length		B Cutoff Allowance		H Hex Size		Maximum Working Pressure	
		inch	mm	inch	mm	inch	mm	psi	MPa
#									
6019X-12-12	3/4" NPT	3.88	99	1.58	40	1.07	27	6,960	48.0
1019X-16-12	1" NPT	4.10	104	1.78	45	1.42	36	6,960	48.0

Contact Technical Services for specific application information.

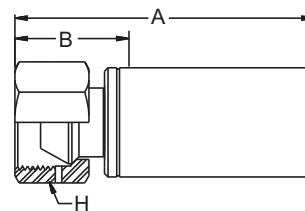
*Skydrol® is a registered trademark of Solutia, Inc.



Type "M" Female Swivel Fitting AY

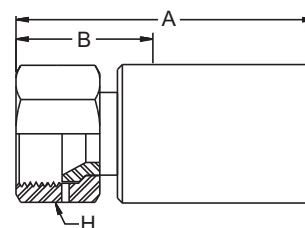

Part Number	Connection Type Thread Size	A Overall Length		B Cutoff Allowance		H Hex Size		Maximum Working Pressure	
		inch	mm	inch	mm	inch	mm	psi	MPa
#									
6AYLX-16-12C	1-5/16" - 12	4.15	105	1.52	39	1.50	38	6,960	48.0

JIC Female Swivel Fitting 06



Part Number	Connection Type Thread Size	A Overall Length		B Cutoff Allowance		H Hex Size		Maximum Working Pressure	
		inch	mm	inch	mm	inch	mm	psi	MPa
#									
1069X-12-12	1-1/16" - 12	4.00	102	1.69	43	1.42	36	6,960	48.0
1069X-16-12	1-5/16" - 12	3.93	100	1.57	40	1.62	41	6,960	48.0
606LX-16-12C	1-5/16" - 12	4.29	109	1.68	43	1.50	38	6,960	48.0

2245N-16 **polyflex** Hose

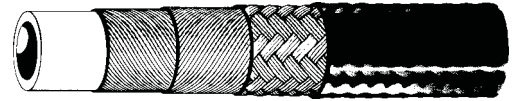

Part Number	Jacket Color	Minimum I.D.		Maximum O.D.		Maximum Working Pressure with 2.5:1		Maximum Working Pressure with 4:1		Minimum Burst Pressure		Minimum Bend Radius		Weight	
		inch	mm	inch	mm	psi	MPa	psi	MPa	psi	MPa	inch	mm	lbs/ft	kg/m
#															
2245N-16V30	Black	1.00	25	1.34	34	6,380	44.0	3,990	27.5	15,950	110.0	11.02	280	0.78	1.16

B

Construction: Polyamide core tube, high strength wire reinforced and a polyamide outer cover.

Temperature Range: -40°F and +140°F (-40°C and +60°C). Contact **polyflex** for temperatures outside this range.

Typical Applications: Lightweight, chemical resistant hose used to replace steel pipe and rubber hose for hydraulic test systems using synthetic and phosphate ester fluids, such as Skydrol®* fluids and gas transfer service.

National Pipe Tapered (NPT) Male Fitting 01

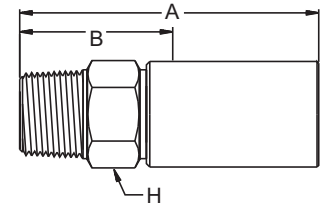





Part Number	Connection Type Thread Size	A Overall Length		B Cutoff Allowance		H Hex Size		Maximum Working Pressure	
		inch	mm	inch	mm	inch	mm	psi	MPa
#									
1019X-16-16	1" NPT	4.10	104	1.78	45	1.42	36	6,380	44.0
6019X-16-16C	1" NPT	4.38	111	2.25	57	1.38	35	6,380	44.0

Contact Technical Services for specific application information.

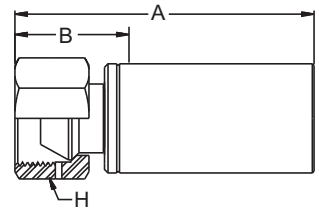
*Skydrol® is a registered trademark of Solutia, Inc.



Type "M" Female Swivel Fitting AY

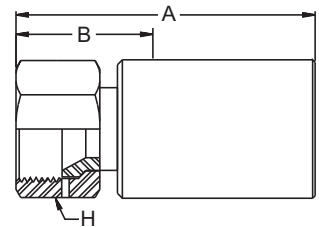

Part Number	Connection Type Thread Size	A Overall Length		B Cutoff Allowance		H Hex Size		Maximum Working Pressure	
		inch	mm	inch	mm	inch	mm	psi	MPa
#									
6AY9X-16-16C	1-5/16" - 12	3.79	96	1.65	42	1.50	38	6,380	44.0

JIC Female Swivel Fitting 06



Part Number	Connection Type Thread Size	A Overall Length		B Cutoff Allowance		H Hex Size		Maximum Working Pressure	
		inch	mm	inch	mm	inch	mm	psi	MPa
#									
6069X-16-16C	1-5/16" - 12	3.79	96	1.65	42	1.50	38	6,380	44.0
1069X-16-16	1-5/16" - 12	4.04	103	1.76	45	1.62	41	6,380	44.0

2380F-05 **polyflex** Hose

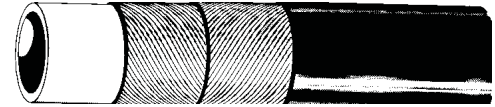

Part Number	Jacket Color	Minimum I.D.		Maximum O.D.		Maximum Working Pressure with 2.5:1		Maximum Working Pressure with 4:1		Minimum Burst Pressure		Minimum Bend Radius		Weight	
		inch	mm	inch	mm	psi	MPa	psi	MPa	psi	MPa	inch	mm	lbs/ft	kg/m
#															
2380F-05V07	Gray	0.32	8	0.56	14	8,700	60.0	5,437	37.5	21,750	150.0	3.35	85	0.24	0.36

Construction: Fluorinatedethylene-propylene polymer core tube, high strength wire reinforced and a polyurethane outer cover.

Typical Applications: FEP inner core offers exceptional chemical resistance for applications with aggressive fluids.

Temperature Range: -40°F and +140°F (-40°C and +60°C). Contact **polyflex** for temperatures outside this range. Temperatures higher than 140°F are possible. Contact division for additional information.

B

National Pipe Tapered (NPT) Male Fitting

01

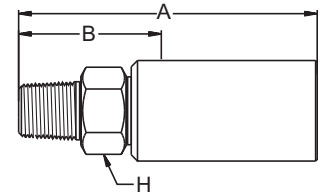

Part Number	Connection Type Thread Size	A Overall Length		B Cutoff Allowance		H Hex Size		Maximum Working Pressure	
		inch	mm	inch	mm	inch	mm	psi	MPa
#									
101NX-6-5	3/8" NPT	2.52	64	1.18	30	0.75	19	8,700	60.0

JIC Female Swivel Fitting

06

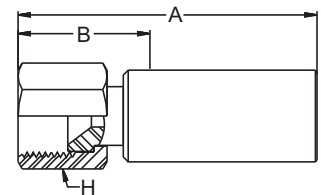

Part Number	Connection Type Thread Size	A Overall Length		B Cutoff Allowance		H Hex Size		Maximum Working Pressure	
		inch	mm	inch	mm	inch	mm	psi	MPa
#									
106NX-6-05	9/16" - 18	2.38	60	1.03	26	0.75	19	8,700	60.0

2380F-08 **polyflex** Hose

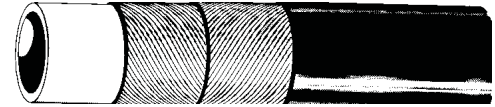

Part Number	Jacket Color	Minimum I.D.		Maximum O.D.		Maximum Working Pressure with 2.5:1		Maximum Working Pressure with 4:1		Minimum Burst Pressure		Minimum Bend Radius		Weight	
		inch	mm	inch	mm	psi	MPa	psi	MPa	psi	MPa	inch	mm	lbs/ft	kg/m
#															
2380F-08V07	Gray	0.50	13	0.81	21	7,540	52.0	4,710	32.5	18,850	130.0	5.51	140	0.39	0.58

Construction: Fluorinatedethylene-propylene polymer core tube, high strength wire reinforced and a polyurethane outer cover.

Temperature Range: -40°F and +140°F (-40°C and +60°C). Contact **polyflex** for temperatures outside this range. Temperatures higher than 140°F are possible. Contact division for additional information.

Typical Applications: FEP inner core offers exceptional chemical resistance for applications with aggressive fluids.

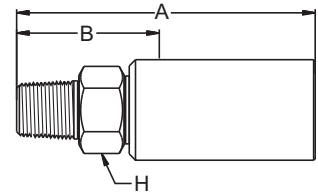

National Pipe Tapered (NPT) Male Fitting 01

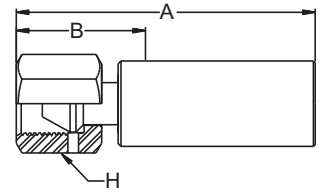

Part Number	Connection Type Thread Size	A Overall Length		B Cutoff Allowance		H Hex Size		Maximum Working Pressure	
		inch	mm	inch	mm	inch	mm	psi	MPa
#									
6019X-8-8C	1/2" NPT	3.37	86	1.68	43	1.00	25	7,540	52.0
1019X-8-8	1/2" NPT	3.35	85	1.43	36	0.87	22	7,540	52.0

Type "M" Female Swivel Fitting AY





Part Number	Connection Type Thread Size	A Overall Length		B Cutoff Allowance		H Hex Size		Maximum Working Pressure	
		inch	mm	inch	mm	inch	mm	psi	MPa
#									
6AY9X-11-8C	1" - 12	3.20	81	1.50	38	1.25	32	7,540	52.0

B

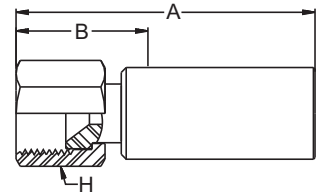
JIC Female Swivel Fitting 06



Part Number	Connection Type Thread Size	A Overall Length		B Cutoff Allowance		H Hex Size		Maximum Working Pressure	
		inch	mm	inch	mm	inch	mm	psi	MPa
#									
6069X-8-8C	3/4" - 16	3.00	76	1.30	33	0.87	22	7,540	52.0

2380F-12 **polyflex** Hose

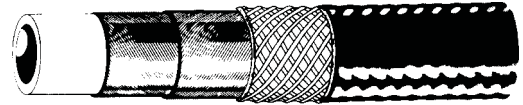

Part Number	Jacket Color	Minimum I.D.		Maximum O.D.		Maximum Working Pressure with 2.5:1		Maximum Working Pressure with 4:1		Minimum Burst Pressure		Minimum Bend Radius		Weight	
		inch	mm	inch	mm	psi	MPa	psi	MPa	psi	MPa	inch	mm	lbs/ft	kg/m
#															
2380F-12V07	Gray	0.76	19	1.12	28	6,380	44.0	3,987	27.5	15,950	110.0	8.07	205	0.65	0.97

Construction: Fluorinated ethylene-propylene polymer core tube, high strength wire reinforced and a polyurethane outer cover.

Typical Applications: FEP inner core offers exceptional chemical resistance for applications with aggressive fluids.

Temperature Range: -40°F and +140°F (-40°C and +60°C). Contact **polyflex** for temperatures outside this range. Temperatures higher than 140°F are possible. Contact division for additional information.

National Pipe Tapered (NPT) Male Fitting 01

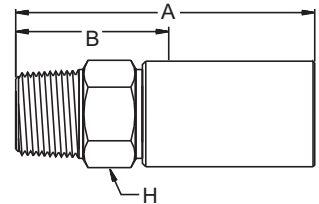

Part Number	Connection Type Thread Size	A Overall Length		B Cutoff Allowance		H Hex Size		Maximum Working Pressure	
		inch	mm	inch	mm	inch	mm	psi	MPa
#									
1019X-12-12	3/4" NPT	3.88	99	1.58	40	1.07	27	6,380	44.0
1019X-16-12	1" NPT	4.10	104	1.78	45	1.42	36	6,380	44.0

Type "M" Female Swivel Fitting AY

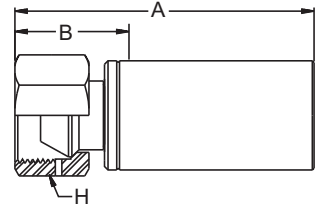

Part Number	Connection Type Thread Size	A Overall Length		B Cutoff Allowance		H Hex Size		Maximum Working Pressure	
		inch	mm	inch	mm	inch	mm	psi	MPa
#									
6AYLX-16-12C	1-5/16" - 12	4.15	105	1.52	39	1.50	38	6,380	44.0

B

JIC Female Swivel Fitting 06

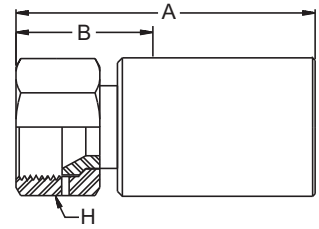

Part Number	Connection Type Thread Size	A Overall Length		B Cutoff Allowance		H Hex Size		Maximum Working Pressure	
		inch	mm	inch	mm	inch	mm	psi	MPa
#									
1069X-12-12	1-1/16" - 12	4.00	102	1.69	43	1.42	36	6,380	44.0
1069X-16-12	1-5/16" - 12	3.93	100	1.57	40	1.62	41	6,380	44.0
606LX-16-12C	1-5/16" - 12	4.29	109	1.68	43	1.50	38	6,380	44.0

2380N-04 **polyflex** Hose

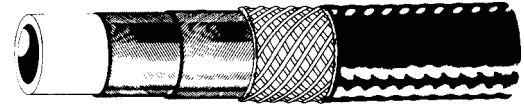

Part Number	Jacket Color	Minimum I.D.		Maximum O.D.		Maximum Working Pressure with 2.5:1		Maximum Working Pressure with 4:1		Minimum Burst Pressure		Minimum Bend Radius		Weight	
		inch	mm	inch	mm	psi	MPa	psi	MPa	psi	MPa	inch	mm	lbs/ft	kg/m
#															
2380N-04V00	Black	0.25	6	0.53	13	16,240	112.0	10,150	70.0	40,600	280.0	2.76	70	0.22	0.33
2380N-04V02	Blue	0.25	6	0.53	13	16,240	112.0	10,150	70.0	40,600	280.0	2.76	70	0.22	0.33
2380N-04V04	Red	0.25	6	0.53	13	16,240	112.0	10,150	70.0	40,600	280.0	2.76	70	0.22	0.33
2380N-04V71	Black	0.25	6	0.53	13	16,240	112.0	10,150	70.0	40,600	280.0	2.76	70	0.22	0.33

Construction: Polyamide core tube, high strength wire reinforced and a polyurethane cover.

Temperature Range: -40°F and +140°F (-40°C and +60°C). Contact **polyflex** for temperatures outside this range.

Typical Applications: Small diameter, low volumetric expansion hose. Ideal for pressure testing, portable hydraulic tools that require extreme kink resistance and maximum flexibility. Available in long single lengths and in Twin-Line construction. The -04V71 is typically used in Methanol injection applications.

National Pipe Tapered (NPT) Male Fitting

01

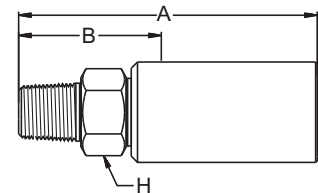

Part Number	Connection Type Thread Size	A Overall Length		B Cutoff Allowance		H Hex Size		Maximum Working Pressure	
		inch	mm	inch	mm	inch	mm	psi	MPa
#									
1018X-6-4	3/8" NPT	2.72	69	1.47	37	0.75	19	15,000	103.4
6018X-4-4	1/4" NPT	2.62	67	1.37	35	0.63	16	15,000	103.4
601LX-4-4C	1/4" NPT	2.62	67	1.37	35	0.63	16	15,000	103.4

Type "M" Female Swivel Fitting

AY

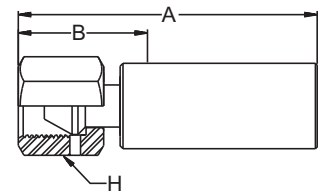

Part Number	Connection Type Thread Size	A Overall Length		B Cutoff Allowance		H Hex Size		Maximum Working Pressure	
		inch	mm	inch	mm	inch	mm	psi	MPa
#									
6AY8X-6-4	9/16" - 18	2.54	65	1.30	33	0.75	19	16,240	112.0
6AYLX-6-4C	9/16" - 18	2.69	68	1.39	35	0.68	17	16,240	112.0
6AYLX-6-4C-SD *	9/16" - 18	2.54	65	1.30	33	0.75	19	16,240	112.0

*SD – Corrosion resistant (sea water)

JIC Female Swivel Fitting

06

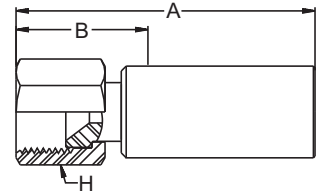

Part Number	Connection Type Thread Size	A Overall Length		B Cutoff Allowance		H Hex Size		Maximum Working Pressure	
		inch	mm	inch	mm	inch	mm	psi	MPa
#									
1068X-4-4	7/16" - 20	2.64	67	1.37	35	0.75	19	10,000	69.0
1068X-6-4	9/16" - 18	2.58	66	1.30	33	0.75	19	10,000	69.0
6069X-4-4C	7/16" - 20	2.24	57	0.98	25	0.63	16	10,000	69.0
6069X-6-4C	9/16" - 18	2.36	60	1.10	28	0.68	17	10,000	69.0

B

Medium Pressure Female Swivel Fitting

5Y

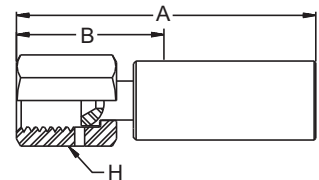

Part Number	Connection Type Thread Size	A Overall Length		B Cutoff Allowance		H Hex Size		Maximum Working Pressure	
		inch	mm	inch	mm	inch	mm	psi	MPa
#									
65Y8X-6-4	9/16" - 18	2.78	71	1.55	39	0.75	19	16,240	112.0
65YLX-6-4C	9/16" - 18	2.84	72	1.54	39	0.75	19	16,240	112.0

BSP Female Swivel Fitting

92

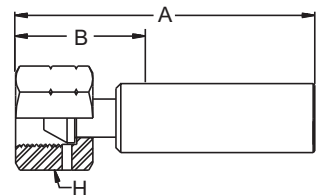

Part Number	Connection Type Thread Size	A Overall Length		B Cutoff Allowance		H Hex Size		Maximum Working Pressure	
		inch	mm	inch	mm	inch	mm	psi	MPa
#									
6928X-4-4	1/4" BSPP	2.51	64	1.27	32	0.75	19	16,240	112.0

BSP Male Fitting

D9

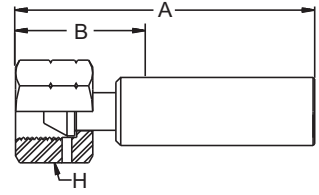

Part Number	Connection Type Thread Size	A Overall Length		B Cutoff Allowance		H Hex Size		Maximum Working Pressure	
		inch	mm	inch	mm	inch	mm	psi	MPa
#									
1D98X-4-4	1/4" BSPP	2.65	67	1.39	35	0.75	19	16,240	112.0

Male Stecko Fitting

MB

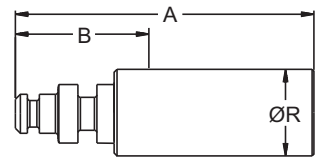

Part Number	Connection Type Thread Size	A Overall Length		B Cutoff Allowance		R Diameter		Maximum Working Pressure	
		inch	mm	inch	mm	inch	mm	psi	MPa
#									
1MB8X-6-4	None	2.85	72	1.58	40	0.86	22	10,000	69.0

Metric Female Swivel Fitting

C3

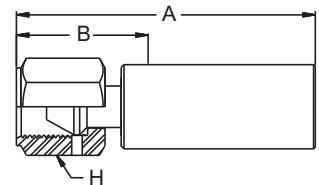

Part Number	Connection Type Thread Size	A Overall Length		B Cutoff Allowance		H Hex Size		Maximum Working Pressure	
		inch	mm	inch	mm	inch	mm	psi	MPa
#									
1C38X-4-4	M14 x 1.5	2.45	62	1.20	30	0.75	19	16,240	112.0

2380N-04 **polyflex** Hose

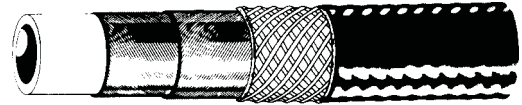

Part Number	Jacket Color	Minimum I.D.		Maximum O.D.		Maximum Working Pressure with 2.5:1		Maximum Working Pressure with 4:1		Minimum Burst Pressure		Minimum Bend Radius		Weight	
		inch	mm	inch	mm	psi	MPa	psi	MPa	psi	MPa	inch	mm	lbs/ft	kg/m
#															
2380N-04V33	Green	0.25	6	0.50	13	13,200	91.0	8,250	56.9	33,000	227.6	3.50	89	0.17	0.25

B

Construction: Polyamide core tube, high strength wire reinforced and a polyamide outer cover.

Temperature Range: -40°F and +140°F (-40°C and +60°C). Contact **polyflex** for temperatures outside this range.

Typical Applications: Replaces high pressure metal tubing in applications where vibration or routing constraints are issues, such as high pressure gas transfer, pressure testing, hydraulic controls, and hydraulic test systems using synthetic and phosphate ester fluids, such as Skydrol®** and gas transfer service. Also used with ProLance fittings for high pressure heat exchanger tube cleaning in petrochemical and power plants.

National Pipe Tapered (NPT) Male Fitting

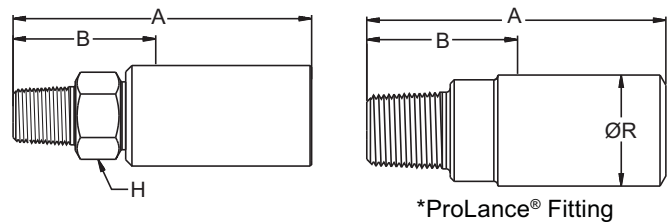

Part Number	Connection Type Thread Size	A Overall Length		B Cutoff Allowance		H Hex Size/ R Diameter		Maximum Working Pressure	
		inch	mm	inch	mm	inch	mm	psi	MPa
#									
101NX-4-4	1/4" NPT	2.57	65	1.35	34	0.63	16	13,200	91.0
101NX-6-4	3/8" NPT	2.63	67	1.38	35	0.75	19	13,200	91.0
601NX-2-4 *	1/8" NPT	1.44	37	0.50	13	0.62	16	13,200	91.0
601NX-4-4 *	1/4" NPT	1.56	40	0.63	16	0.62	16	13,200	91.0
601NX-4-4C	1/4" NPT	2.38	60	1.12	28	0.63	16	13,200	91.0

*ProLance® Fitting

Contact Technical Services for specific application information.



**Skydrol® is a registered trademark of Solutia, Inc.

National Pipe Tapered (NPT) Female Fitting

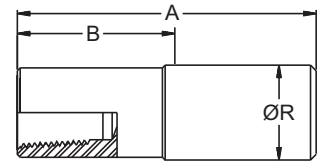
02



*ProLance® Fitting



Part Number	Connection Type Thread Size	A Overall Length		B Cutoff Allowance		R Diameter		Maximum Working Pressure	
		inch	mm	inch	mm	inch	mm	psi	MPa
#									
602NX-4-4 *	1/4" NPT	1.89	48	0.95	24	0.75	19	13,200	91.0

*ProLance® Fitting

Type "M" Female Swivel Fitting

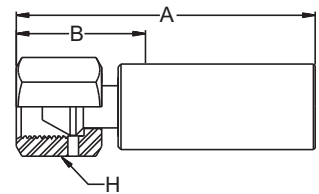
AY





Part Number	Connection Type Thread Size	A Overall Length		B Cutoff Allowance		H Hex Size		Maximum Working Pressure	
		inch	mm	inch	mm	inch	mm	psi	MPa
#									
6AYNX-6-4	9/16" - 18	2.56	65	1.32	34	0.75	19	13,200	91.0
6AYNX-6-4C	9/16" - 18	2.36	60	1.11	28	0.68	17	13,200	91.0

JIC Female Swivel Fitting

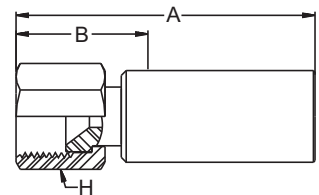
06

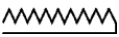

Part Number	Connection Type Thread Size	A Overall Length		B Cutoff Allowance		H Hex Size		Maximum Working Pressure	
		inch	mm	inch	mm	inch	mm	psi	MPa
#									
106NX-4-4	7/16" - 20	2.56	65	1.37	35	0.75	19	10,000	69.0
106NX-6-4	9/16" - 18	2.56	65	1.32	34	0.75	19	10,000	69.0
606NX-4-4C	7/16" - 20	2.23	57	0.99	25	0.63	16	10,000	69.0
606NX-6-4C	9/16" - 18	2.36	60	1.11	28	0.68	17	10,000	69.0

BSP Female Swivel Fitting BC

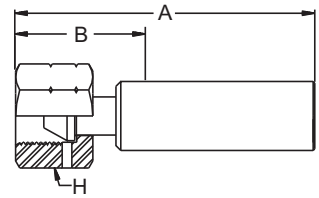

Part Number	Connection Type Thread Size	A Overall Length		B Cutoff Allowance		H Hex Size		Maximum Working Pressure	
		inch	mm	inch	mm	inch	mm	psi	MPa
#									
1BCNX-4-4	1/4" BSPP	2.50	64	1.25	32	0.75	19	13,200	91.0

B

BSP Male Fitting D9

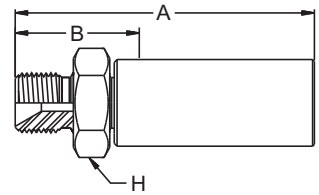

Part Number	Connection Type Thread Size	A Overall Length		B Cutoff Allowance		H Hex Size		Maximum Working Pressure	
		inch	mm	inch	mm	inch	mm	psi	MPa
#									
1D9NX-4-4	1/4" BSPP	2.64	67	1.40	36	0.75	19	13,200	91.0

Male Water Blast Nozzle Fitting 3Z

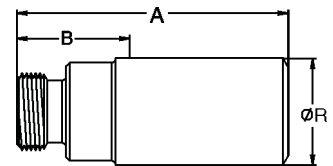

*ProLance® Fitting

Part Number	Connection Type Thread Size	A Overall Length		B Cutoff Allowance		R Diameter		Maximum Working Pressure	
		inch	mm	inch	mm	inch	mm	psi	MPa
#									
63ZNX-5-4C *	5/16" - 32	2.79	71	0.45	11	0.67	17	13,200	91.0

*ProLance® Fitting

2380N-05 **polyflex** Hose

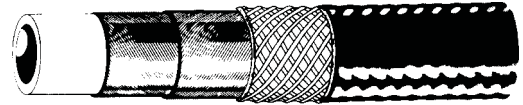

Part Number	Jacket Color	Minimum I.D.		Maximum O.D.		Maximum Working Pressure with 2.5:1		Maximum Working Pressure with 4:1		Minimum Burst Pressure		Minimum Bend Radius		Weight	
		inch	mm	inch	mm	psi	MPa	psi	MPa	psi	MPa	inch	mm	lbs/ft	kg/m
#															
2380N-05V00	Black	0.32	8	0.62	16	13,600	93.8	8,500	58.6	34,000	234.5	3.50	89	0.20	0.30
2380N-05V71	Black	0.32	8	0.62	16	13,600	93.8	8,500	58.6	34,000	234.5	3.50	89	0.20	0.30

Construction: Polyamide core tube, high strength wire reinforced and a polyurethane outer cover

Temperature Range: -40°F and +140°F (-40°C and +60°C). Contact **polyflex** for temperatures outside this range.

Typical Applications: Hydraulic tools, gas transfer, offshore chemical injection service and high pressure testing of equipment. The -05V71 is typically used in methanol injection applications.

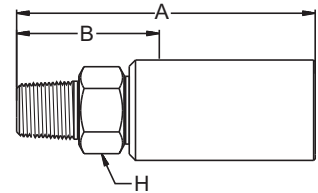

National Pipe Tapered (NPT) Male Fitting 01

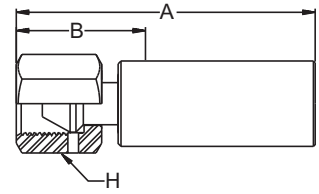

Part Number	Connection Type Thread Size	A Overall Length		B Cutoff Allowance		H Hex Size		Maximum Working Pressure	
		inch	mm	inch	mm	inch	mm	psi	MPa
#									
601LX-4-5C	1/4" NPT	2.78	71	1.18	30	0.63	16	13,600	93.8
601LX-4-5	1/4" NPT	2.78	71	1.18	30	0.63	16	13,600	93.8
601LX-6-5C	3/8" NPT	2.96	75	1.35	34	0.75	19	13,600	93.8
601LX-6-5	3/8" NPT	2.96	75	1.35	34	0.75	19	13,600	93.8

Type "M" Female Swivel Fitting AY







Part Number	Connection Type Thread Size	A Overall Length		B Cutoff Allowance		H Hex Size		Maximum Working Pressure	
		inch	mm	inch	mm	inch	mm	psi	MPa
#									
6AY8X-8-5C *	3/4" - 16	2.95	75	1.25	32	1.00	25	13,600	93.8

*Corrosion resistant (sea water)

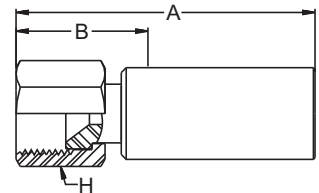
B

JIC Female Swivel Fitting 06



Part Number	Connection Type Thread Size	A Overall Length		B Cutoff Allowance		H Hex Size		Maximum Working Pressure	
		inch	mm	inch	mm	inch	mm	psi	MPa
#									
606LX-6-5C *	9/16" - 18	2.70	69	1.10	28	0.75	19	10,000	69.0
606LX-8-5C	3/4" - 16	2.82	72	1.22	31	1.00	25	10,000	69.0

*Corrosion resistant (sea water)

2390N-04 **polyflex** Hose

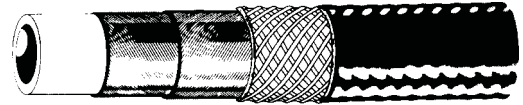

Part Number	Jacket Color	Minimum I.D.		Maximum O.D.		Working Pressure with 2.5:1 Safety Factor		Working Pressure with 4:1 Safety Factor		Minimum Burst Pressure		Minimum Bend Radius		Weight	
		inch	mm	inch	mm	psi	MPa	psi	MPa	psi	MPa	inch	mm	lbs/ft	kg/m
#															
2390N-04V10	Black	0.25	6	0.52	13	12,000	82.8	7,500	51.7	30,000	206.9	3.00	76	0.18	0.27
2390N-04V12	Blue	0.25	6	0.52	13	12,000	82.8	7,500	51.7	30,000	206.9	3.00	76	0.18	0.27
2390N-04V16	Yellow	0.25	6	0.52	13	12,000	82.8	7,500	51.7	30,000	206.9	3.00	76	0.18	0.27

Construction: Polyamide core tube, high tensile strength wire reinforced and a polyurethane cover.

Temperature Range: -40°F and +140°F (-40°C and +60°C). Contact **polyflex** for temperatures outside this range.

Typical Applications: Small diameter, low volumetric expansion hose with sea-water resistant cover. Ideal for pressure testing, portable hydraulic tools and for offshore hydraulic systems.

National Pipe Tapered (NPT) Male Fitting 01

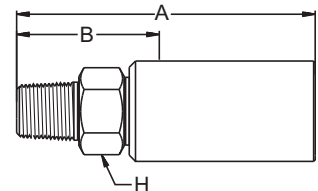

Part Number	Connection Type Thread Size	A Overall Length		B Cutoff Allowance		H Hex Size		Maximum Working Pressure	
		inch	mm	inch	mm	inch	mm	psi	MPa
#									
1018X-6-4	3/8" NPT	2.72	69	1.47	37	0.75	19	12,000	82.8
6018X-4-4	1/4" NPT	2.62	67	1.37	35	0.63	16	12,000	82.8
6019X-4-4C	1/4" NPT	2.38	60	1.12	28	0.63	16	12,000	82.8

Type “M” Female Swivel Fitting AY

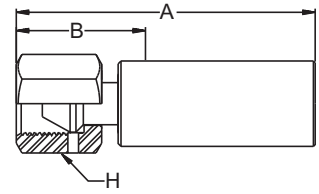

Part Number	Connection Type Thread Size	A Overall Length		B Cutoff Allowance		H Hex Size		Maximum Working Pressure	
		inch	mm	inch	mm	inch	mm	psi	MPa
#									
6AY8X-6-4	9/16" - 18	2.54	65	1.30	33	0.75	19	12,000	82.8
6AY9X-6-4C	9/16" - 18	2.36	60	1.10	28	0.68	17	12,000	82.8

B

JIC Female Swivel Fitting 06

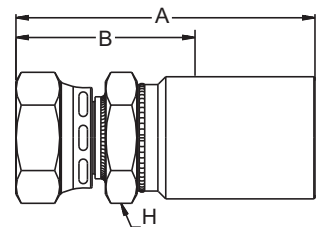
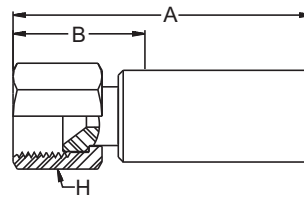

SubSea™ Fitting

Part Number	Connection Type Thread Size	A Overall Length		B Cutoff Allowance		H Hex Size		Maximum Working Pressure	
		inch	mm	inch	mm	inch	mm	psi	MPa
#									
6069X-4-4C	7/16" - 20	2.24	57	0.98	25	0.63	16	10,000	69.0
6069X-6-4C	9/16" - 18	2.36	60	1.10	28	0.68	17	10,000	69.0
E206JCC3 *	7/16" - 20	2.12	54	1.20	30	0.63	16	10,000	69.0
E206JEC3 *	9/16" - 18	2.20	56	1.12	28	0.75	19	10,000	69.0

*SubSea™ fitting — specially manufactured for deepwater drilling applications.

BSP Female Swivel Fitting 92

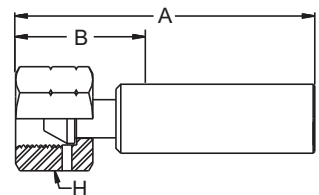

Part Number	Connection Type Thread Size	A Overall Length		B Cutoff Allowance		H Hex Size		Maximum Working Pressure	
		inch	mm	inch	mm	inch	mm	psi	MPa
#									
1928X-4-4	1/4" BSPP	2.51	64	1.27	32	0.75	19	12,000	82.8

BSP Male Fitting

D9

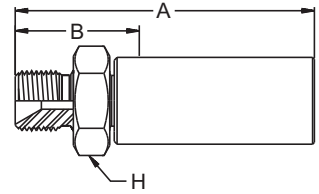

Part Number	Connection Type Thread Size	A Overall Length		B Cutoff Allowance		H Hex Size		Maximum Working Pressure	
		inch	mm	inch	mm	inch	mm	psi	MPa
#									
1D98X-4-4	1/4" BSPP	2.65	67	1.39	35	0.75	19	12,000	82.8

Medium Pressure Female Swivel Fitting

5Y

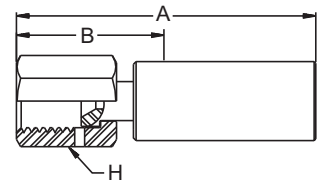

Part Number	Connection Type Thread Size	A Overall Length		B Cutoff Allowance		H Hex Size		Maximum Working Pressure	
		inch	mm	inch	mm	inch	mm	psi	MPa
#									
65Y8X-6-4	9/16" - 18	2.78	71	1.55	39	0.75	19	12,000	82.8
65YLX-6-4C	9/16" - 18	2.84	72	1.54	39	0.75	19	12,000	82.8

2390N-06 **polyflex** Hose

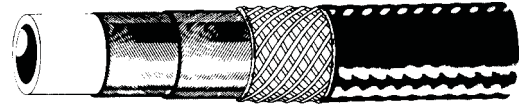

Part Number	Jacket Color	Minimum I.D.		Maximum O.D.		Maximum Working Pressure with		Maximum Working Pressure with		Minimum Burst Pressure		Minimum Bend Radius		Weight	
		inch	mm	inch	mm	psi	MPa	psi	MPa	psi	MPa	inch	mm	lbs/ft	kg/m
#															
2390N-06V13	Green	0.40	10	0.70	18	10,300	71.0	6,450	44.5	25,810	178.0	3.00	76	0.28	0.42

Construction: Polyamide core tube, high tensile strength wire reinforced and a polyurethane cover.

Temperature Range: -40°F and +140°F (-40°C and +60°C). Contact **polyflex** for temperatures outside this range.

Typical Applications: Low volumetric expansion hose for use with petroleum or synthetic hydraulic fluids, and in long lengths for waterblasting, pipe cleaning and line moleing applications.

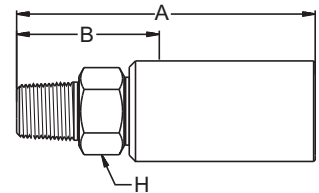

National Pipe Tapered (NPT) Male Fitting 01



Part Number	Connection Type Thread Size	A Overall Length		B Cutoff Allowance		H Hex Size		Maximum Working Pressure	
		inch	mm	inch	mm	inch	mm	psi	MPa
#									
6019X-6-6	3/8" NPT	2.95	75	1.35	34	0.75	19	10,300	71.0
6019X-6-6C	3/8" NPT	2.95	75	1.35	34	0.75	19	10,300	71.0
6019X-8-6	1/2" NPT	3.16	80	1.56	40	0.87	22	10,300	71.0
6019X-8-6C	1/2" NPT	3.16	80	1.56	40	0.87	22	10,300	71.0

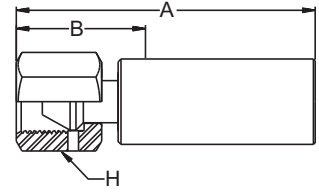

Type "M" Female Swivel Fitting AY

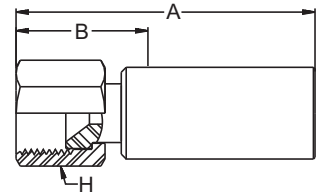

Part Number	Connection Type Thread Size	A Overall Length		B Cutoff Allowance		H Hex Size		Maximum Working Pressure	
		inch	mm	inch	mm	inch	mm	psi	MPa
#									
6AY9X-8-6C	3/4" - 16	2.79	71	1.19	30	1.00	25	10,300	71.0

JIC Female Swivel Fitting 06

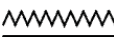

Part Number	Connection Type Thread Size	A Overall Length		B Cutoff Allowance		H Hex Size		Maximum Working Pressure	
		inch	mm	inch	mm	inch	mm	psi	MPa
#									
6069X-8-6C	3/4" - 16	2.79	71	1.19	30	1.00	25	10,000	69.0

2390N-08 **polyflex** Hose

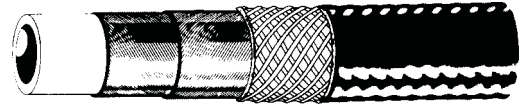

Part Number	Jacket Color	Minimum I.D.		Maximum O.D.		Maximum Working Pressure with 2.5:1		Maximum Working Pressure with 4:1		Minimum Burst Pressure		Minimum Bend Radius		Weight	
		inch	mm	inch	mm	psi	MPa	psi	MPa	psi	MPa	inch	mm	lbs/ft	kg/m
#															
2390N-08V12	Blue	0.50	13	0.81	21	10,400	71.7	6,500	44.8	26,000	179.3	4.00	102	0.38	0.57
2390N-08V13	Green	0.50	13	0.81	21	10,400	71.7	6,500	44.8	26,000	179.3	4.00	102	0.38	0.57
2390N-08V16	Yellow	0.50	13	0.81	21	10,400	71.7	6,500	44.8	26,000	179.3	4.00	102	0.38	0.57

B

Construction: Polyamide core tube, high strength wire reinforced and a polyurethane outer cover.

Temperature Range: -40°F and +140°F (-40°C and +60°C). Contact **polyflex** for temperatures outside this range.

Typical Applications: Low volumetric expansion hose with sea-water resistant cover. Used in subsea hydraulic B.O.P. control systems, and in long lengths for pipe cleaning applications.

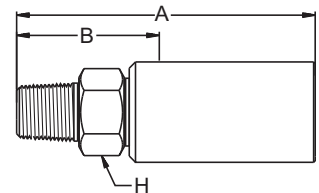

National Pipe Tapered (NPT) Male Fitting 01

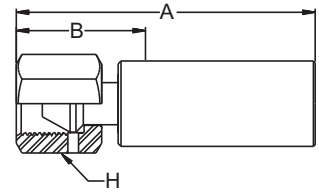

Part Number	Connection Type Thread Size	A Overall Length		B Cutoff Allowance		H Hex Size		Maximum Working Pressure	
		inch	mm	inch	mm	inch	mm	psi	MPa
#									
6019X-8-8	1/2" NPT	3.35	85	1.43	36	0.87	22	10,400	71.7
6019X-8-8C	1/2" NPT	3.37	86	1.68	43	1.00	25	10,400	71.7

Type "M" Female Swivel Fitting AY



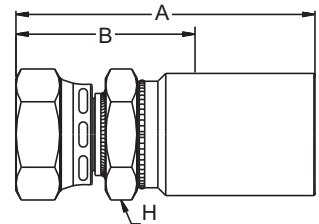
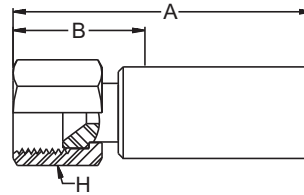

Part Number	Connection Type Thread Size	A Overall Length		B Cutoff Allowance		H Hex Size		Maximum Working Pressure	
		inch	mm	inch	mm	inch	mm	psi	MPa
#									
6AY9X-11-8C	1" - 12	3.20	81	1.50	38	1.25	32	10,400	71.7

JIC Female Swivel Fitting 06

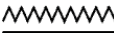

*SubSea Fitting

Part Number	Connection Type Thread Size	A Overall Length		B Cutoff Allowance		H Hex Size		Maximum Working Pressure	
		inch	mm	inch	mm	inch	mm	psi	MPa
#									
6069X-8-8C	3/4" - 16	3.00	76	1.30	33	0.87	22	10,000	69.0
E213JFC4 *	3/4" - 16	3.35	85	1.61	41	0.94	24	10,000	69.0

*SubSea Fitting

2390N-12 **polyflex** Hose

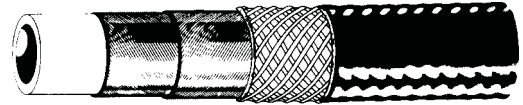

Part Number	Jacket Color	Minimum I.D.		Maximum O.D.		Maximum Working Pressure with 2.5:1		Maximum Working Pressure with 4:1		Minimum Burst Pressure		Minimum Bend Radius		Weight	
		inch	mm	inch	mm	psi	MPa	psi	MPa	psi	MPa	inch	mm	lbs/ft	kg/m
#															
2390N-12V03	Green	0.81	21	1.14	29	8,100	55.9	5,575	38.4	22,300	153.8	6.00	152	0.63	0.94

B

Construction: Polyamide core tube, high strength wire reinforced and a polyurethane outer cover.

Temperature Range: -40°F and +140°F (-40°C and +60°C). Contact **polyflex** for temperatures outside this range.

Typical Applications: Flexible, kink-resistant construction suitable for chemical fluids and operations of hydraulic tools and equipment.

National Pipe Tapered (NPT) Male Fitting 01

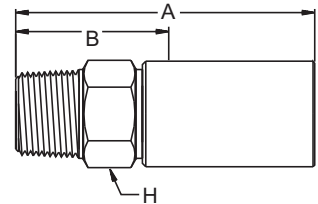

Part Number	Connection Type Thread Size	A Overall Length		B Cutoff Allowance		H Hex Size		Maximum Working Pressure	
		inch	mm	inch	mm	inch	mm	psi	MPa
#									
6019X-12-12	3/4" NPT	3.88	99	1.58	40	1.07	27	8,100	55.9
1019X-16-12	1" NPT	4.10	104	1.78	45	1.42	36	8,100	55.9
601LX-12-12C	3/4" NPT	4.75	121	2.10	53	1.38	35	8,100	55.9
601LX-16-12C	1" NPT	4.90	124	2.25	57	1.38	35	8,100	55.9

Type "M" Female Swivel Fitting AY

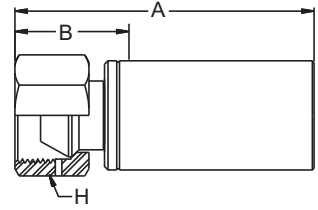

Part Number	Connection Type Thread Size	A Overall Length		B Cutoff Allowance		H Hex Size		Maximum Working Pressure	
		inch	mm	inch	mm	inch	mm	psi	MPa
#									
6AYLX-16-12C	1-5/16" - 12	4.15	105	1.52	39	1.50	38	8,100	55.9

JIC Female Swivel Fitting 06

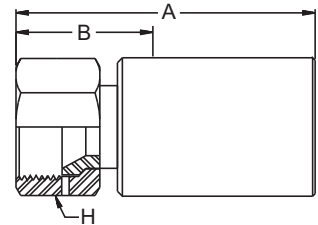

Part Number	Connection Type Thread Size	A Overall Length		B Cutoff Allowance		H Hex Size		Maximum Working Pressure	
		inch	mm	inch	mm	inch	mm	psi	MPa
#									
1069X-12-12	1-1/16" - 12	4.00	102	1.69	43	1.42	36	8,100	55.9
1069X-16-12	1-5/16" - 12	3.93	100	1.57	40	1.62	41	8,100	55.9
606LX-16-12C	1-5/16" - 12	4.29	109	1.68	43	1.50	38	8,100	55.9

2390N-16 **polyflex** Hose

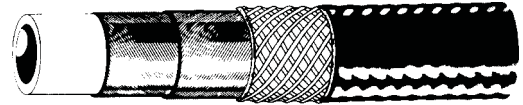

Part Number	Jacket Color	Minimum I.D.		Maximum O.D.		Maximum Working Pressure with 2.5:1		Maximum Working Pressure with 4:1		Minimum Burst Pressure		Minimum Bend Radius		Weight	
		inch	mm	inch	mm	psi	MPa	psi	MPa	psi	MPa	inch	mm	lbs/ft	kg/m
#															
2390N-16V12	Blue	1.00	25	1.37	35	6,500	44.8	4,100	28.3	16,420	113.2	8.00	203	0.84	1.25
2390N-16V13	Green	1.00	25	1.37	35	6,500	44.8	4,100	28.3	16,420	113.2	8.00	203	0.84	1.25
2390N-16V16	Yellow	1.00	25	1.37	35	6,500	44.8	4,100	28.3	16,420	113.2	8.00	203	0.84	1.25

B

Construction: Polyamide core tube, high strength wire reinforced and a polyurethane outer cover.

Temperature Range: -40°F and +140°F (-40°C and +60°C). Contact **polyflex** for temperatures outside this range.

Typical Applications: Low volumetric expansion hose with sea-water resistant cover. Used for subsea hydraulic controls, and as long single length hot-line hose for B.O.P. systems.

National Pipe Tapered (NPT) Male Fitting 01

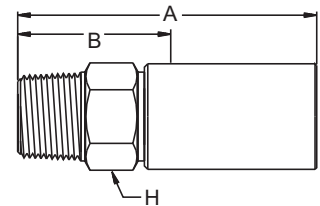

Part Number	Connection Type Thread Size	A Overall Length		B Cutoff Allowance		H Hex Size		Maximum Working Pressure	
		inch	mm	inch	mm	inch	mm	psi	MPa
#									
1019X-16-16	1" NPT	4.10	104	1.78	45	1.42	36	6,500	44.8
6019X-16-16C	1" NPT	4.38	111	2.25	57	1.38	35	6,500	44.8

Type "M" Female Swivel Fitting AY

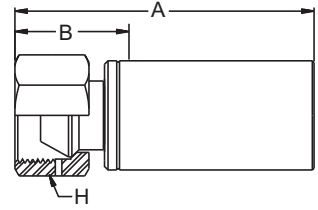

Part Number	Connection Type Thread Size	A Overall Length		B Cutoff Allowance		H Hex Size		Maximum Working Pressure	
		inch	mm	inch	mm	inch	mm	psi	MPa
#									
6AY9X-16-16C	1-5/16" - 12	3.79	96	1.65	42	1.50	38	6,500	44.8

JIC Female Swivel Fitting 06

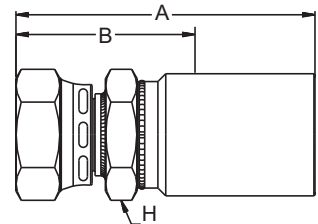
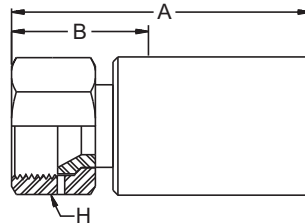

*SubSea Fitting

Part Number	Connection Type Thread Size	A Overall Length		B Cutoff Allowance		H Hex Size		Maximum Working Pressure	
		inch	mm	inch	mm	inch	mm	psi	MPa
#									
1069X-16-16	1-5/16" - 12	4.04	103	1.76	45	1.62	41	6,500	44.8
6069X-16-16C	1-5/16" - 12	3.79	96	1.65	42	1.50	38	6,500	44.8
E225JIC3 *	1-5/16" - 12	4.30	109	2.10	53	1.63	41	6,500	44.8

*SubSea Fitting

2440D-025 **polyflex** Hose

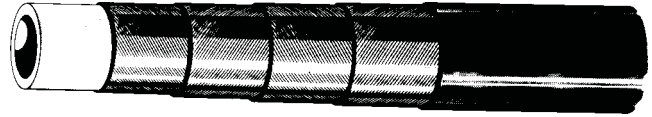

Part Number	Jacket Color	Minimum I.D.		Maximum O.D.		Maximum Working Pressure		Burst Pressure		Minimum Bend Radius		Weight	
		inch	mm	inch	mm	psi	MPa	psi	MPa	inch	mm	lbs/ft	kg/m
#													
2440D-025V37	Gray	0.16	4	0.41	10	31,900	220.0	79,750	550.0	4.10	104	0.13	0.19

B

Construction: Polyoxymethylene core tube, high strength wire reinforced and a polyamide outer cover.

Temperature Range: -40°F and +140°F (-40°C and +60°C). Contact **polyflex** for temperatures outside this range.

Typical Applications: Small diameter flexible hose. Ideal for tight routing applications such as hydraulic tools and high pressure heat exchanger tube cleaning in petrochemical and power plants. Especially suitable for hydraulic pre-tensioning equipment and specialized pressure fitted sleeve and coupling removal equipment.

National Pipe Tapered (NPT) Male Fitting 01

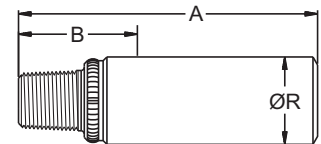

*ProLance® Fitting

Part Number	Connection Type Thread Size	A Overall Length		B Cutoff Allowance		H Hex Size		Maximum Working Pressure	
		inch	mm	inch	mm	inch	mm	psi	MPa
#									
601LX-2-2AC *	1/8" NPT ProLance	1.90	48	0.76	19	0.50	13	15,000	103.4

*ProLance® Fitting

Type "M" Female Swivel Fitting AY

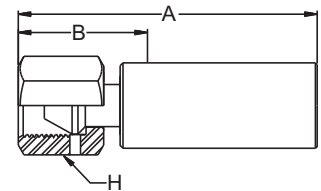

Part Number	Connection Type Thread Size	A Overall Length		B Cutoff Allowance		H Hex Size		Maximum Working Pressure	
		inch	mm	inch	mm	inch	mm	psi	MPa
#									
6AYLX-6-2AC	9/16" - 18	2.51	64	1.28	33	0.68	17	31,900	220.0

High Pressure Tube Nipple Y4

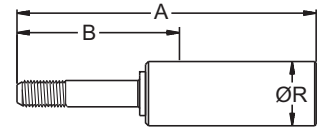

Part Number	Connection Type Thread Size	A Overall Length		B Cutoff Allowance		R Diameter		Maximum Working Pressure	
		inch	mm	inch	mm	inch	mm	psi	MPa
#									
6Y4LX-4-2AC	1/4" - 28 LH	2.96	75	1.71	43	0.63	16	31,900	220.0
6Y4LX-6-2AC	3/8" - 24 LH	3.40	86	2.16	55	0.63	16	31,900	220.0

Male Water Jetting Nozzle Fitting YH

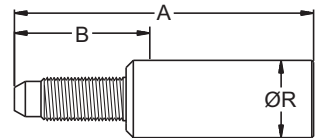

*ProLance® Fitting

Part Number	Connection Type Thread Size	A Overall Length		B Cutoff Allowance		R Diameter		Maximum Working Pressure	
		inch	mm	inch	mm	inch	mm	psi	MPa
#									
6YHLX-4-2AC-LH	1/4" - 28 LH	2.10	53	0.87	22	0.50	13	31,900	220.0

*ProLance® Fitting

Female Water Jetting Nozzle Fitting HY

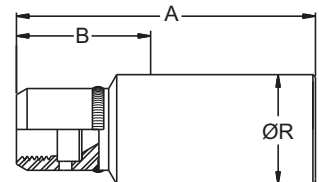

*ProLance® Fitting

Part Number	Connection Type Thread Size	A Overall Length		B Cutoff Allowance		R Diameter		Maximum Working Pressure	
		inch	mm	inch	mm	inch	mm	psi	MPa
#									
6HYLX-4-2AC	1/4" - 28 RH	1.91	49	0.81	21	0.5	13	31,900	220.0

*ProLance® Fitting

2440D-03 **polyflex** Hose

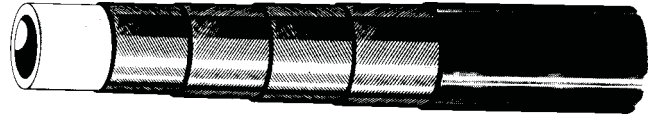

Part Number	Jacket Color	Minimum I.D.		Maximum O.D.		Maximum Working Pressure		Burst Pressure		Minimum Bend Radius		Weight	
		inch	mm	inch	mm	psi	MPa	psi	MPa	inch	mm	lbs/ft	kg/m
#													
2440D-03V37	Gray	0.20	5	0.45	11	26,100	180.0	65,250	450.0	5.12	130	0.19	0.28

Construction: Polyoxymethylene core tube, high strength wire reinforced and a polyamide outer cover.

Temperature Range: -40°F and +140°F (-40°C and +60°C). Contact **polyflex** for temperatures outside this range.

Typical Applications: Small diameter flexible hose. Ideal for tight routing applications such as hydraulic tools, pressure testing and high pressure heat exchanger tube cleaning, and other water blasting applications in petrochemical and power plants and general industry. Especially suitable for hydraulic pre-tensioning equipment and specialized pressure fitted sleeve and coupling removal equipment.

National Pipe Tapered (NPT) Male Fitting 01

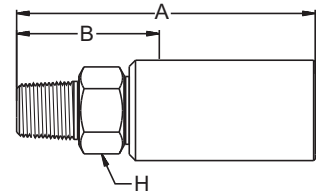

Part Number	Connection Type Thread Size	A Overall Length		B Cutoff Allowance		H Hex Size		Maximum Working Pressure	
		inch	mm	inch	mm	inch	mm	psi	MPa
#									
601LX-4-3	1/4" NPT	2.86	73	1.30	33	0.56	14	15,000	103.4

Type "M" Female Swivel Fitting AY

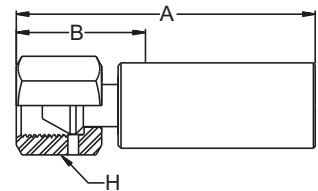

Part Number	Connection Type Thread Size	A Overall Length		B Cutoff Allowance		H Hex Size		Maximum Working Pressure	
		inch	mm	inch	mm	inch	mm	psi	MPa
#									
6AYLX-6-3	9/16" - 18	2.80	71	1.28	33	0.75	19	26,100	180.0
6AYLX-6-3C	9/16" - 18	2.93	74	1.42	36	0.68	17	26,100	180.0

High Pressure Tube Nipple Fitting Y4

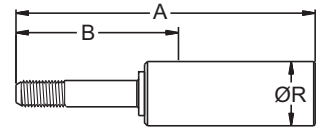

Part Number	Connection Type Thread Size	A Overall Length		B Cutoff Allowance		R Diameter		Maximum Working Pressure	
		inch	mm	inch	mm	inch	mm	psi	MPa
#									
6Y4LX-6-3C	3/8" - 24 LH	3.86	98	2.35	60	0.67	17	26,100	180.0
6Y4LX-9-3C	9/16" - 18 LH	4.20	107	2.70	69	0.67	17	26,100	180.0

Male Water Jetting Nozzle Fitting YH

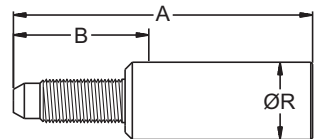

Part Number	Connection Type Thread Size	A Overall Length		B Cutoff Allowance		R Diameter		Maximum Working Pressure	
		inch	mm	inch	mm	inch	mm	psi	MPa
#									
6YHLX-4-3C-LH	1/4" - 28 LH	2.71	69	1.52	39	0.60	15	26,100	180.0
6YHLX-6-3C	3/8" - 24 RH	2.61	66	1.41	36	0.60	15	26,100	180.0
6YHLX-6-3C-LH	3/8" - 24 LH	2.61	66	1.41	36	0.60	15	26,100	180.0

High Pressure Female Swivel Fitting 6Y

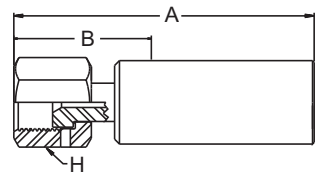

Part Number	Connection Type Thread Size	A Overall Length		B Cutoff Allowance		H Hex Size		Maximum Working Pressure	
		inch	mm	inch	mm	inch	mm	psi	MPa
#									
66YLX-4-3	9/16" - 18	2.80	71	1.28	33	0.75	19	26,100	180.0
66YLX-4-3C	9/16" - 18	2.93	74	1.42	36	0.68	17	26,100	180.0

Medium Pressure Female Swivel Fitting 5Y

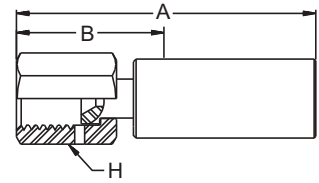

Part Number	Connection Type Thread Size	A Overall Length		B Cutoff Allowance		H Hex Size		Maximum Working Pressure	
		inch	mm	inch	mm	inch	mm	psi	MPa
#									
65YLX-6-3	9/16" - 18	3.08	78	1.53	39	0.75	19	20,000	137.9

B

BSP Female Swivel Fitting 92

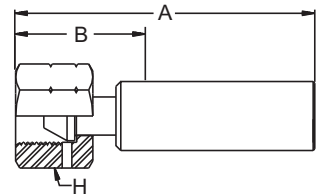

Part Number	Connection Type Thread Size	A Overall Length		B Cutoff Allowance		H Hex Size		Maximum Working Pressure	
		inch	mm	inch	mm	inch	mm	psi	MPa
#									
192LX-4-3	1/4" BSPP	2.95	75	1.38	35	0.75	19	26,100	180.0
692LX-4-3C	1/4" BSPP	2.83	72	1.30	33	0.88	22	26,100	180.0

Male Water Jetting Nozzle Fitting 3Z & ZE

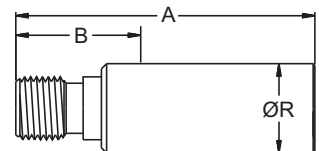



Part Number	Connection Type Thread Size	A Overall Length		B Cutoff Allowance		R Diameter		Maximum Working Pressure	
		inch	mm	inch	mm	inch	mm	psi	MPa
#									
6ZELX-5-3C	5/16" - 24 RH	2.22	56	1.10	28	0.60	15	20,000	137.9

Female Water Jetting Nozzle Fitting

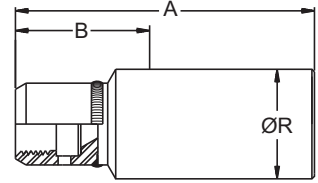
HY

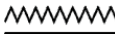

Part Number	Connection Type Thread Size	A Overall Length		B Cutoff Allowance		R Diameter		Maximum Working Pressure	
		inch	mm	inch	mm	inch	mm	psi	MPa
#									
6HYLX-6-3C	3/8" - 24 RH	1.98	50	0.70	18	0.63	16	26,100	180.0

2440N-04 **polyflex** Hose

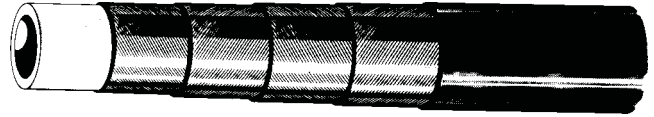

Part Number	Jacket Color	Minimum I.D.		Maximum O.D.		Maximum Working Pressure		Minimum Burst Pressure		Minimum Bend Radius		Weight	
		inch	mm	inch	mm	psi	MPa	psi	MPa	inch	mm	lbs/ft	kg/m
#													
2440N-04V37	Gray	0.25	6	0.50	13	20,000	137.9	50,000	345	6.10	155	0.22	0.33
2440N-04V91	Black	0.25	6	0.50	13	20,000	137.9	50,000	345	6.10	155	0.22	0.33

B

Construction: Polyamide core tube, high strength wire reinforced and a polyamide outer cover.

Temperature Range: -40°F and +140°F (-40°C and +60°C). Contact **polyflex** for temperatures outside this range.

Typical Applications: Small diameter, chemical resistant hose for hydraulic tools, pressure testing, offshore chemical injection and high pressure heat exchanger tube cleaning in petrochemical and power plants. The -04V91 is typically used in methanol injection applications.

National Pipe Tapered (NPT) Male Fitting

01

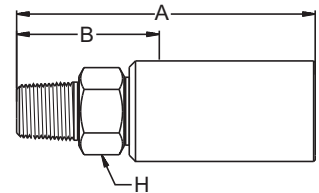

Part Number	Connection Type Thread Size	A Overall Length		B Cutoff Allowance		H Hex Size		Maximum Working Pressure	
		inch	mm	inch	mm	inch	mm	psi	MPa
#									
601LX-2-4	1/8" NPT	2.50	64	1.20	30	0.63	16	15,000	103.4
601LX-4-4	1/4" NPT	2.61	66	1.32	33	0.63	16	15,000	103.4
601LX-4-4C	1/4" NPT	2.62	67	1.34	34	0.63	16	15,000	103.4

Type "M" Female Swivel Fitting AY

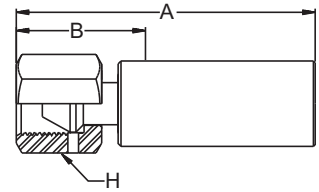

Part Number	Connection Type Thread Size	A Overall Length		B Cutoff Allowance		H Hex Size		Maximum Working Pressure	
		inch	mm	inch	mm	inch	mm	psi	MPa
#									
6AYLX-6-4	9/16" - 18	2.63	67	1.32	33	0.75	19	20,000	137.9
6AYLX-6-4C	9/16" - 18	2.69	68	1.39	35	0.68	17	20,000	137.9
6AYLX-6-4C-SD *	9/16" - 18	2.69	68	1.39	35	0.68	17	20,000	137.9

*SD = Corrosion Resistant (seawater) — specially designed for aggressive fluids found in offshore drilling applications.

BSP Female Swivel Fitting 92

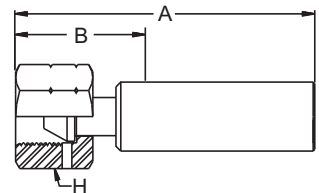

Part Number	Connection Type Thread Size	A Overall Length		B Cutoff Allowance		H Hex Size		Maximum Working Pressure	
		inch	mm	inch	mm	inch	mm	psi	MPa
#									
692LX-4-4	1/4" BSPP	2.51	64	1.21	31	0.87	22	20,000	137.9

Male Water Jetting Nozzle Fitting YH

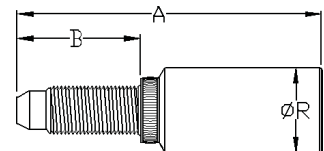

Part Number	Connection Type Thread Size	A Overall Length		B Cutoff Allowance		R Diameter		Maximum Working Pressure	
		inch	mm	inch	mm	inch	mm	psi	MPa
#									
6YHLX-6-4C	3/8" - 24 RH	2.60	66	1.41	36	0.67	17	20,000	137.9
6YHLX-6-4C-LH	3/8" - 24 LH	2.60	66	1.41	36	0.67	17	20,000	137.9

Medium Pressure Female Swivel Fitting 5Y

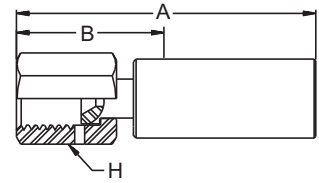

Part Number	Connection Type Thread Size	A Overall Length		B Cutoff Allowance		H Hex Size		Maximum Working Pressure	
		inch	mm	inch	mm	inch	mm	psi	MPa
#									
65YLX-6-4	9/16" - 18	2.84	72	1.54	39	0.75	19	20,000	137.9
65YLX-6-4C	9/18" - 18	2.84	72	1.54	39	0.75	19	20,000	137.9

B

Female Water Jetting Nozzle Fitting HY

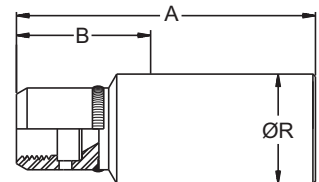

Part Number	Connection Type Thread Size	A Overall Length		B Cutoff Allowance		R Diameter		Maximum Working Pressure	
		inch	mm	inch	mm	inch	mm	psi	MPa
#									
6HYLX-6-4C	3/8" - 24 RH	1.83	46	0.60	15	0.67	17	20,000	137.9

2440D-05 **polyflex** Hose

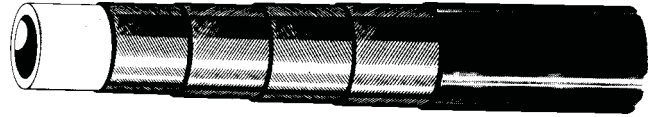

Part Number	Jacket Color	Minimum I.D.		Maximum O.D.		Maximum Working Pressure		Minimum Burst Pressure		Minimum Bend Radius		Weight	
		inch	mm	inch	mm	psi	MPa	psi	MPa	inch	mm	lbs/ft	kg/m
#													
2440D-05V37	Gray	0.32	8	0.61	15	21,750	150.0	54,370	375.0	6.88	175	0.30	0.45

Construction: Polyoxymethylene core tube, high strength wire reinforced and a polyamide outer cover.

Temperature Range: -40°F and +140°F (-40°C and +60°C). Contact **polyflex** for temperatures outside this range.

Typical Applications: Chemical resistant hose for hydraulic tools, pressure testing of offshore equipment and high pressure heat exchanger tube cleaning in petrochemical and power plants.

National Pipe Tapered (NPT) Male Fitting 01

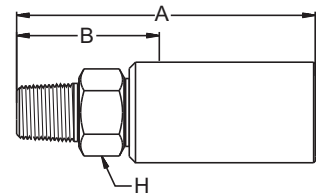

Part Number	Connection Type Thread Size	A Overall Length		B Cutoff Allowance		H Hex Size		Maximum Working Pressure	
		inch	mm	inch	mm	inch	mm	psi	MPa
#									
601LX-4-5	1/4" NPT	2.78	71	1.18	30	0.63	16	15,000	103.4
601LX-4-5C	1/4" NPT	2.78	71	1.18	30	0.63	16	15,000	103.4
601LX-6-5	3/8" NPT	2.96	75	1.37	35	0.75	19	15,000	103.4
601LX-6-5C	3/8" NPT	2.96	75	1.37	35	0.75	19	15,000	103.4

Type "M" Female Swivel Fitting AY

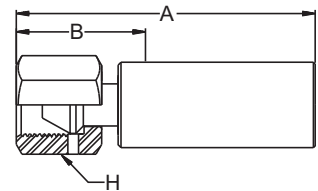

Part Number	Connection Type Thread Size	A Overall Length		B Cutoff Allowance		H Hex Size		Maximum Working Pressure	
		inch	mm	inch	mm	inch	mm	psi	MPa
#									
6AYLX-8-5C	3/4" - 16	2.95	75	1.25	32	1.00	25	21,750	150.0

Medium Pressure Tube Nipple

Y2

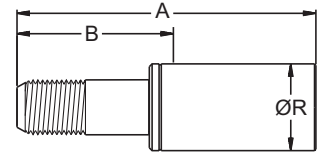

Part Number	Connection Type Thread Size	A Overall Length		B Cutoff Allowance		R Diameter		Maximum Working Pressure	
		inch	mm	inch	mm	inch	mm	psi	MPa
#									
6Y2LX-9-5C	9/16" - 18 LH	3.83	97	2.13	54	0.95	24	20,000	137.9
6Y2LX-12-5C	3/4" - 16 LH	3.74	95	2.05	52	0.95	24	20,000	137.9
E408LCA2	9/16" - 18 LH (Long Tube)	4.53	115	2.83	72	0.95	24	20,000	137.9
E408LCA3	9/16" - 18 LH (7/8" Thread)	3.83	97	2.13	54	0.95	24	20,000	137.9

B

Female Water Jetting Nozzle Fitting

HY

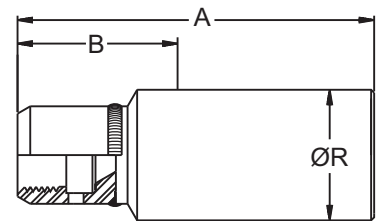

Part Number	Connection Type Thread Size	A Overall Length		B Cutoff Allowance		R Diameter		Maximum Working Pressure	
		inch	mm	inch	mm	inch	mm	psi	MPa
#									
6HYLX-9-5C-LH	9/16" - 18 LH	2.60	66	0.88	22	0.82	21	20,000	137.9

BSP Female Swivel Fitting

92

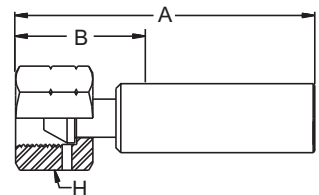

Part Number	Connection Type Thread Size	A Overall Length		B Cutoff Allowance		H Hex Size		Maximum Working Pressure	
		inch	mm	inch	mm	inch	mm	psi	MPa
#									
692LX-6-5C	3/8" BSPP	2.90	74	1.20	30	1.06	27	21,750	150.0

2440N-06 **polyflex** Hose

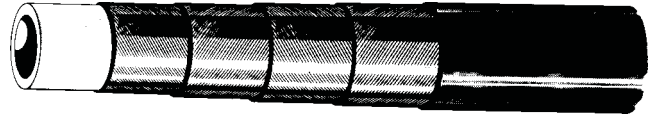

Part Number	Jacket Color	Minimum I.D.		Maximum O.D.		Maximum Working Pressure		Minimum Burst Pressure		Minimum Bend Radius		Weight	
		inch	mm	inch	mm	psi	MPa	psi	MPa	inch	mm	lbs/ft	kg/m
#													
2440N-06V91	Black	0.40	10	0.77	20	20,300	140.0	50,750	350.0	7.50	191	0.47	0.70

Construction: Polyamide core tube, high strength wire reinforced and a polyamide outer cover.

Temperature Range: -40°F and +140°F (-40°C and +60°C). Contact **polyflex** for temperatures outside this range.

Typical Applications: Chemical resistant hose for hydraulic tools, pressure testing of offshore equipment and high pressure heat exchanger tube cleaning in petrochemical and power plants.

Type "M" Female Swivel Fitting AY

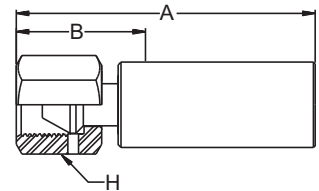

Part Number	Connection Type Thread Size	A Overall Length		B Cutoff Allowance		H Hex Size		Maximum Working Pressure	
		inch	mm	inch	mm	inch	mm	psi	MPa
#									
6AYLX-8-6C	3/4" - 16	2.95	75	1.25	32	1.00	25	20,300	140.0

Medium Pressure Tube Nipples Y2

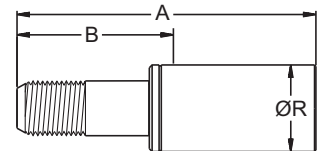

Part Number	Connection Type Thread Size	A Overall Length		B Cutoff Allowance		R Diameter		Maximum Working Pressure	
		inch	mm	inch	mm	inch	mm	psi	MPa
#									
6Y2LX-9-6C	9/16" - 18 LH	3.80	97	2.04	52	1.22	31	20,000	137.9

2440N-08 **polyflex** Hose

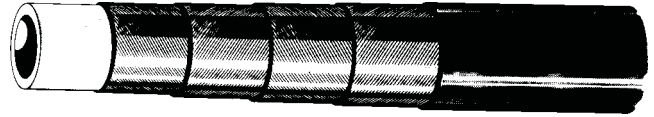

Part Number	Jacket Color	Minimum I.D.		Maximum O.D.		Maximum Working Pressure		Minimum Burst Pressure		Minimum Bend Radius		Weight	
		inch	mm	inch	mm	psi	MPa	psi	MPa	inch	mm	lbs/ft	kg/m
#													
2440N-08V30	Black	0.50	13	0.88	22	18,850	130	47,125	325	7.87	200	0.63	0.94
2440N-08V91	Black	0.50	13	0.88	22	18,850	130	47,125	325	7.87	200	0.63	0.94

Construction: Polyamide core tube, high strength wire reinforced and a polyamide outer cover.

Temperature Range: -40°F and +140°F (-40°C and +60°C). Contact **polyflex** for temperatures outside this range.

Typical Applications: Flexible, lightweight, chemical resistant alternative to steel pipe and rubber hose for applications such as waterblasting, gas transfer, chemical injection, wireline logging services, and pressure testing. The -08V91 is typically used in methanol injection applications.

National Pipe Tapered (NPT) Male Fitting 01

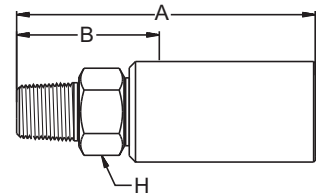

Part Number	Connection Type Thread Size	A Overall Length		B Cutoff Allowance		H Hex Size		Maximum Working Pressure	
		inch	mm	inch	mm	inch	mm	psi	MPa
#									
601LX-8-8	1/2" NPT	3.75	95	1.70	43	1.13	29	15,000	103.4
601LX-8-8C	1/2" NPT	3.75	95	1.70	43	1.13	29	15,000	103.4

Type “M” Female Swivel Fitting AY

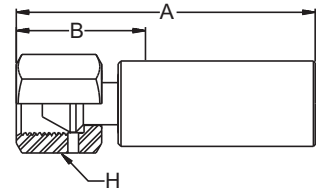

Part Number	Connection Type Thread Size	A Overall Length		B Cutoff Allowance		H Hex Size		Maximum Working Pressure	
		inch	mm	inch	mm	inch	mm	psi	MPa
#									
6AYLX-11-8C	1" - 12	3.53	90	1.50	38	1.25	32	18,850	130
6AYLX-11-8C-SD *	1" - 12	3.53	90	1.50	38	1.25	32	18,850	130

*SD = Corrosion Resistant (seawater) — specially designed for aggressive fluids found in offshore drilling applications.

Medium Pressure Tube Nipples Y2

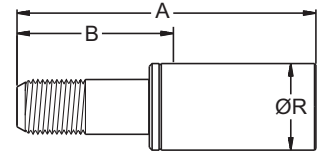

Part Number	Connection Type Thread Size	A Overall Length		B Cutoff Allowance		R Diameter		Maximum Working Pressure	
		inch	mm	inch	mm	inch	mm	psi	MPa
#									
6Y2LX-9-8C	9/16" - 18 LH	4.20	107	2.20	56	1.13	29	18,850	130
6Y2LX-12-8C	3/4" - 16 LH	4.13	105	2.08	53	1.13	29	18,850	130

Metric Female Swivel Fitting C9

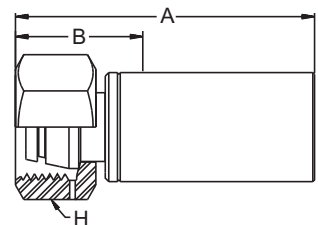

Part Number	Connection Type Thread Size	A Overall Length		B Cutoff Allowance		H Hex Size		Maximum Working Pressure	
		inch	mm	inch	mm	inch	mm	psi	MPa
#									
6C9LX-16-8C	M24 x 1.5	3.48	88	1.44	37	1.26	32	18,850	130

2440N-12 **polyflex** Hose

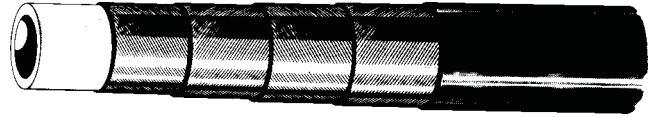

Part Number	Jacket Color	Minimum I.D.		Maximum O.D.		Maximum Working Pressure		Minimum Burst Pressure		Minimum Bend Radius		Weight	
		inch	mm	inch	mm	psi	MPa	psi	MPa	inch	mm	lbs/ft	kg/m
#													
2440N-12V37	Gray	0.81	21	1.19	30	15,000	103.4	37,500	258.6	10.00	254	0.93	1.39
2440N-12V91	Black	0.81	21	1.19	30	15,000	103.4	37,500	258.6	10.00	254	0.93	1.39

B

Construction: Polyamide core tube, high strength wire reinforced and a polyamide outer cover.

Temperature Range: -40°F and +140°F (-40°C and +60°C). Contact **polyflex** for temperatures outside this range.

Typical Applications: Flexible, chemical resistant alternative to steel pipe for applications such as water-blasting, hydrodemolition, gas transfer, hydraulic workover and chemical injection. The -12V91 is typically used in Methanol injection applications.

National Pipe Tapered (NPT) Male Fitting

01

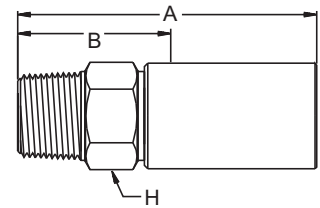

Part Number	Connection Type Thread Size	A Overall Length		B Cutoff Allowance		H Hex Size		Maximum Working Pressure	
		inch	mm	inch	mm	inch	mm	psi	MPa
#									
601LX-12-12C	3/4" NPT	4.75	121	2.10	53	1.38	35	10,000	69.0
601LX-16-12C	1" NPT	4.90	124	2.25	57	1.38	35	10,000	69.0

Type "M" Female Swivel Fitting

AY

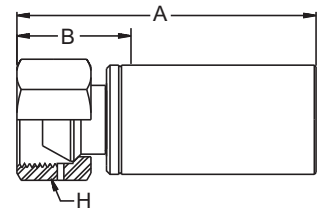

Part Number	Connection Type Thread Size	A Overall Length		B Cutoff Allowance		H Hex Size		Maximum Working Pressure	
		inch	mm	inch	mm	inch	mm	psi	MPa
#									
6AYLX-16-12C	1-5/16" - 12	4.15	105	1.52	39	1.50	38	15,000	103.4
6AYLX-16-12C-SD	1-5/16" - 12	4.29	109	1.64	42	1.50	38	15,000	103.4

*SD = Corrosion Resistant (seawater) — specially designed for aggressive fluids found in offshore drilling applications.

Medium Pressure Tube Nipples

Y2

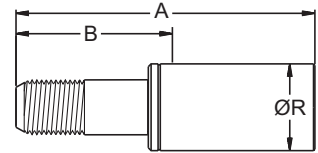

Part Number	Connection Type Thread Size	A Overall Length		B Cutoff Allowance		R Diameter		Maximum Working Pressure	
		inch	mm	inch	mm	inch	mm	psi	MPa
#									
6Y2LX-16-12C	1" - 14 LH	5.39	137	2.75	70	1.56	40	15,000	103.4

Metric Female Swivel Fitting

C9

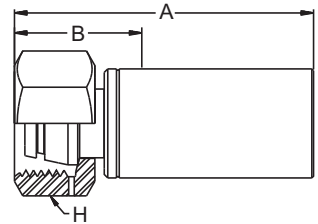

Part Number	Connection Type Thread Size	A Overall Length		B Cutoff Allowance		H Hex Size		Maximum Working Pressure	
		inch	mm	inch	mm	inch	mm	psi	MPa
#									
6C9LX-25-12C	M36 x 2	4.26	108	1.58	40	1.81	46	15,000	103.4

JIC Female Swivel Fitting

06

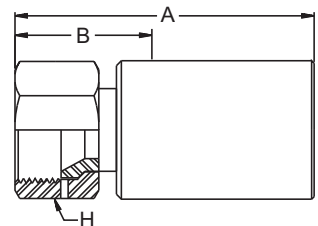

Part Number	Connection Type Thread Size	A Overall Length		B Cutoff Allowance		H Hex Size		Maximum Working Pressure	
		inch	mm	inch	mm	inch	mm	psi	MPa
#									
606LX-16-12C	1-5/16" - 12	4.29	109	1.68	43	1.50	38	10,000	69.0

2440N-16 **polyflex** Hose

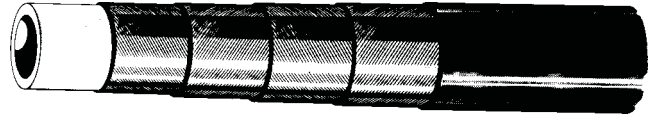

Part Number	Jacket Color	Minimum I.D.		Maximum O.D.		Maximum Working Pressure		Minimum Burst Pressure		Minimum Bend Radius		Weight	
		inch	mm	inch	mm	psi	MPa	psi	MPa	inch	mm	lbs/ft	kg/m
#													
2440N-16V37	Gray	1.00	25	1.46	37	13,050	90.0	32,625	225.0	12.00	305	1.28	1.91
2440N-16V91	Black	1.00	25	1.46	37	13,050	90.0	32,625	225.0	12.00	305	1.28	1.91

Construction: Polyamide core tube, high strength wire reinforced and a polyamide outer cover.

Temperature Range: -40°F and +140°F (-40°C and +60°C). Contact **polyflex** for temperatures outside this range.

Typical Applications: Flexible, chemical resistant alternative to steel pipe for applications such as waterblasting, gas transfer, hydraulic workover and chemical injection. The -16V91 is typically used in Methanol injection applications.

National Pipe Tapered (NPT) Male Fitting

01

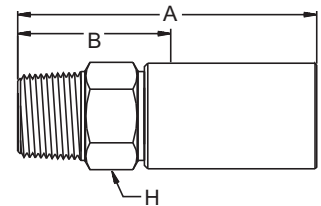

Part Number	Connection Type Thread Size	A Overall Length		B Cutoff Allowance		H Hex Size		Maximum Working Pressure	
		inch	mm	inch	mm	inch	mm	psi	MPa
#									
601LX-16-16C	1" NPT	5.00	125	2.50	64	1.38	35	10,000	69.0

Type "M" Female Swivel Fitting

AY

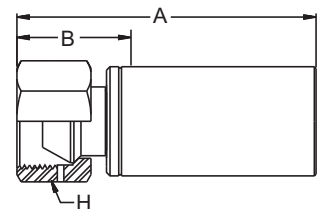

Part Number	Connection Type Thread Size	A Overall Length		B Cutoff Allowance		H Hex Size		Maximum Working Pressure	
		inch	mm	inch	mm	inch	mm	psi	MPa
#									
6AYLX-16-16C	1-5/16" - 12	5.45	139	2.04	52	1.50	38	13,050	90.0
6AYLX-16-16-HCL	1-5/16" - 12	5.45	139	2.04	52	1.50	38	13,050	90.0
6AYLX-16-16C-SD	1-5/16" - 12	5.45	139	2.04	52	1.50	38	13,050	90.0

**HCL = For hydrochloric acid solutions up to 15% by mole

*SD = Corrosion Resistant (seawater) — specially designed for aggressive fluids found in offshore drilling applications.

B

JIC Female Swivel Fitting

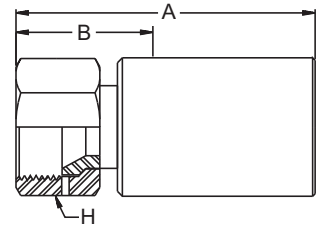

Part Number	Connection Type Thread Size	A Overall Length		B Cutoff Allowance		H Hex Size		Maximum Working Pressure	
		inch	mm	inch	mm	inch	mm	psi	MPa
#									
606LX-16-16C	1-5/16" - 12	3.79	96	1.65	42	1.5	38	10,000	69.0

1" Hammer Union (Fig. 1502) Male Cone with Wing Nut End Fitting HE

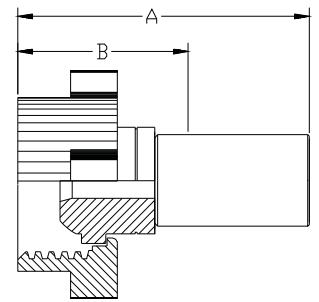

Part Number	Connection Type Thread Size	A Overall Length		B Cutoff Allowance		H Hex Size		Maximum Working Pressure	
		inch	mm	inch	mm	inch	mm	psi	MPa
#									
6HELX-16-16-TC	2-15/16" - 2.5 ACME	6	153	3.63	92.2	N/A	N/A	13,050	90.0

1" Hammer Union (Fig. 1502) Female Cone, Threaded End with Seal HN

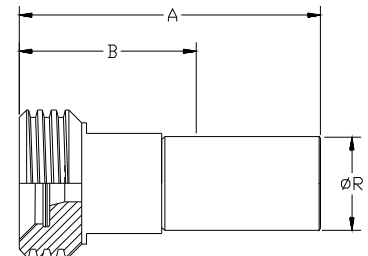

Part Number	Connection Type Thread Size	A Overall Length		B Cutoff Allowance		R Diameter		Maximum Working Pressure	
		inch	mm	inch	mm	inch	mm	psi	MPa
#									
6HNLX-16-16-TC	2-15/16" - 2.5 ACME	6	153	3.63	92.2	1.87	47.5	13,050	90.0

2440N-32 **polyflex** Hose

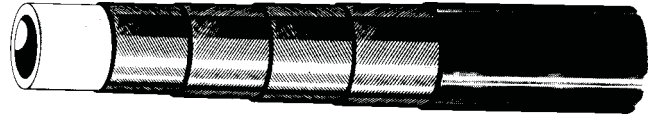

Part Number	Jacket Color	Minimum I.D.		Maximum O.D.		Maximum Working Pressure		Minimum Burst Pressure		Minimum Bend Radius		Weight	
		inch	mm	inch	mm	psi	MPa	psi	MPa	inch	mm	lbs/ft	kg/m
#													
2440N-32V10	Black	2.00	51	2.71	69	5,000	34.5	20,000	137.9	20.00	508	3.50	5.22

Construction: Polyamide core tube, high strength wire reinforced and a polyurethane outer cover.

Temperature Range: -40°F and +140°F (-40°C and +60°C). Contact **polyflex** for temperatures outside this range.

Typical Applications: Flexible, chemical resistant alternative to steel pipe and multi-spiral 100R13 hoses for applications such as high volume flow rate pumping offshore, oilfield well service cementing, chemical injection and gas transfer. High pressure hydraulic applications with aggressive fluids, and as large flow waterblast delivery hose to multiple work stations.

National Pipe Tapered (NPT) Male Fitting 01

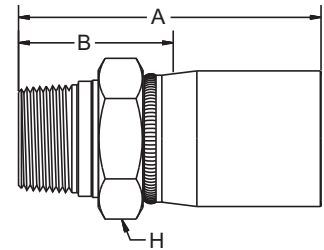

Part Number	Connection Type Thread Size	A Overall Length		B Cutoff Allowance		H Hex Size		Maximum Working Pressure	
		inch	mm	inch	mm	inch	mm	psi	MPa
#									
601LX-32-32	2" NPT	5.57	141	3.00	76	2.50	64	5,000	34.5

JIC Female Swivel Fitting 06

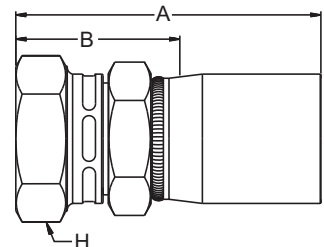



Part Number	Connection Type Thread Size	A Overall Length		B Cutoff Allowance		H Hex Size		Maximum Working Pressure	
		inch	mm	inch	mm	inch	mm	psi	MPa
#									
606LX-32-32	2-1/2" -12	5.57	141	3.00	76	2.50	64	5,000	34.5

B

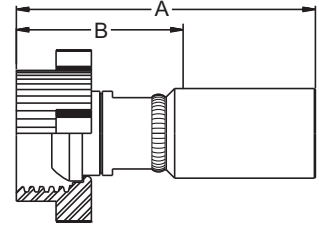

2" Hammer Union (Fig. 1502) Male Cone with Wing Nut End Fitting HE

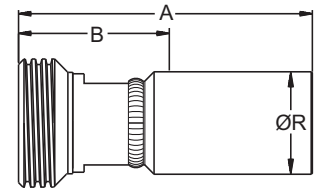

Part Number	Connection Type Thread Size	A Overall Length		B Cutoff Allowance		H Hex Size		Maximum Working Pressure	
		inch	mm	inch	mm	inch	mm	psi	MPa
#									
6HELX-32-32-TC	4-1/8" - 3 ACME	*	*	*	*	N/A	N/A	5,000	34.5

2" Hammer Union (Fig. 1502) Female Cone, Threaded End with Seal HN

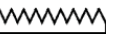

Part Number	Connection Type Thread Size	A Overall Length		B Cutoff Allowance		R Diameter		Maximum Working Pressure	
		inch	mm	inch	mm	inch	mm	psi	MPa
#									
6HNLX-32-32-TC	4-1/8" - 3 ACME	*	*	*	*	*	*	5,000	34.5

Note: Other End Connections Are Available. Please Contact Polyflex For More information.

2640D-025 **polyflex** Hose



Part Number	Jacket Color	Minimum I.D.		Maximum O.D.		Maximum Working Pressure		Minimum Burst Pressure		Minimum Bend Radius		Weight	
		inch	mm	inch	mm	psi	MPa	psi	MPa	inch	mm	lbs/ft	kg/m
#													
2640D-025V32	Blue	0.16	4	0.48	12	40,600	280.0	101,500	700.0	5.50	140	0.20	0.30

B

Construction: Polyoxymethylene core tube, high strength wire reinforced and a polyamide outer cover.

Temperature Range: -40°F and +140°F (-40°C and +60°C). Contact **polyflex** for temperatures outside this range.

Typical Applications: Small diameter flexible hose, ideal for tight routing applications such as hydraulic tools, and high pressure heat exchanger tube cleaning in petrochemical and power plants. Especially suitable for hydraulic pre-tensioning equipment, specialized pressure fitted sleeve and coupling removal equipment. Pressure testing, operations of portable jacks and remote pressure sensing devices.

Type "M" Female Swivel Fitting AY

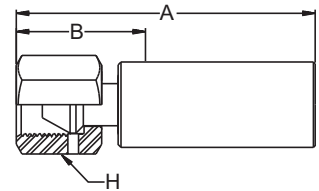

Part Number	Connection Type Thread Size	A Overall Length		B Cutoff Allowance		H Hex Size		Maximum Working Pressure	
		inch	mm	inch	mm	inch	mm	psi	MPa
#									
6AYHX-6-2AC	9/16" - 18	3.13	79	1.33	34	0.69	18	40,600	280.0

High Pressure Tube Nipple Y4

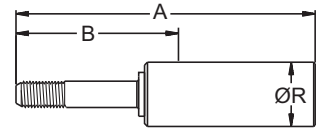

Part Number	Connection Type Thread Size	A Overall Length		B Cutoff Allowance		R Diameter		Maximum Working Pressure	
		inch	mm	inch	mm	inch	mm	psi	MPa
#									
6Y4HX-4-2AC	1/4" - 28 LH	3.50	89	1.75	44	0.68	17	40,600	280.0
6Y4HX-6-2AC	3/8" - 24 LH	3.95	100	2.20	56	0.68	17	40,600	280.0

High Pressure Female Swivel Fitting 6Y

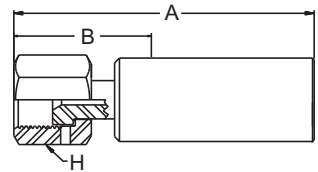

Part Number	Connection Type Thread Size	A Overall Length		B Cutoff Allowance		H Hex Size		Maximum Working Pressure	
		inch	mm	inch	mm	inch	mm	psi	MPa
#									
66YHX-4-2AC	9/16" - 18	3.13	79	1.33	34	0.69	18	40,600	280.0

2640D-03 **polyflex** Hose



Part Number	Jacket Color	Minimum I.D.		Maximum O.D.		Maximum Working Pressure		Minimum Burst Pressure		Minimum Bend Radius		Weight	
		inch	mm	inch	mm	psi	MPa	psi	MPa	inch	mm	lbs/ft	kg/m
#													
2640D-03V32	Blue	0.20	5	0.51	13	36,250	250.0	90,620	625.0	6.88	175	0.27	0.40

Construction: Polyoxymethylene core tube, high strength wire reinforced and a polyamide outer cover.

Temperature Range: -40°F and +140°F (-40°C and +60°C). Contact **polyflex** for temperatures outside this range.

Typical Applications: High pressure waterblast cleaning of heat exchanger tubes in petrochemical and power plants. Especially suitable for hydraulic pre-tensioning equipment and specialized pressure fitted sleeve and coupling removal equipment. Pressure testing, operations of portable jacks and remote pressure sensing devices.

B

Type "M" Female Swivel Fitting AY

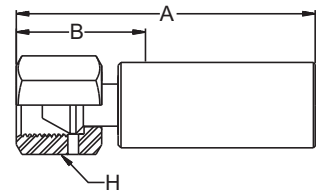

Part Number	Connection Type Thread Size	A Overall Length		B Cutoff Allowance		H Hex Size		Maximum Working Pressure	
		inch	mm	inch	mm	inch	mm	psi	MPa
#									
6AY5X-6-3	9/16" - 18	3.07	78	1.29	33	0.75	19	36,250	250.0
6AY5X-6-3C	9/16" - 18	3.10	79	1.43	36	0.69	18	36,250	250.0

High Pressure Tube Nipple Y4

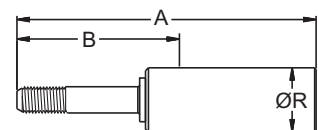

Part Number	Connection Type Thread Size	A Overall Length		B Cutoff Allowance		R Diameter		Maximum Working Pressure	
		inch	mm	inch	mm	inch	mm	psi	MPa
#									
6Y45X-6-3C	3/8" - 24 LH	4.06	103	2.35	60	0.75	19	36,250	250.0
6Y45X-9-3C	9/16" - 18 LH	4.42	112	2.70	69	0.75	19	36,250	250.0

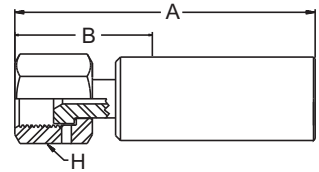

High Pressure Female Swivel Fitting 6Y

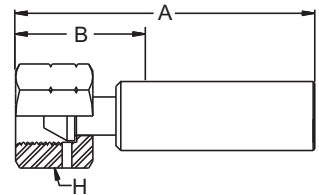

Part Number	Connection Type Thread Size	A Overall Length		B Cutoff Allowance		H Hex Size		Maximum Working Pressure	
		inch	mm	inch	mm	inch	mm	psi	MPa
#									
66Y5X-4-3	9/16" - 18	3.07	78	1.29	33	0.75	19	36,250	250.0
66Y5X-4-3C	9/16" - 18	3.10	79	1.43	36	0.69	18	36,250	250.0

BSP Female Swivel Fitting 92



Part Number	Connection Type Thread Size	A Overall Length		B Cutoff Allowance		H Hex Size		Maximum Working Pressure	
		inch	mm	inch	mm	inch	mm	psi	MPa
#									
1925X-4-3	1/4" BSPP	3.07	78	1.26	32	0.87	22	36,250	250.0

2640N-08 **polyflex** Hose



Part Number	Jacket Color	Minimum I.D.		Maximum O.D.		Maximum Working Pressure		Minimum Burst Pressure		Minimum Bend Radius		Weight	
		inch	mm	inch	mm	psi	MPa	psi	MPa	inch	mm	lbs/ft	kg/m
#													
2640N-08V32	Blue	0.50	13	0.97	25	26,100	180.0	65,250	450.0	11.41	290	0.91	1.36

Construction: Polyamide core tube, high strength wire reinforced and a polyamide outer cover.

Typical Applications: Flexible, chemical resistant alternative to steel pipe delivery hose in waterblasting, hydrodemolition systems, chemical injection and gas transfer, oil field wireline logging services, and pressure testing.

Temperature Range: -40°F and +140°F (-40°C and +60°C). Contact **polyflex** for temperatures outside this range.

Type "M" Female Swivel Fitting AY

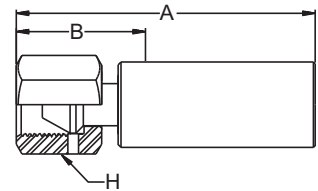

Part Number	Connection Type Thread Size	A Overall Length		B Cutoff Allowance		H Hex Size		Maximum Working Pressure	
		inch	mm	inch	mm	inch	mm	psi	MPa
#									
6AY5X-11-8C	1" - 12	4.25	108	1.72	44	1.25	32	26,100	180.0

B

Medium Pressure Tube Nipple

Y2

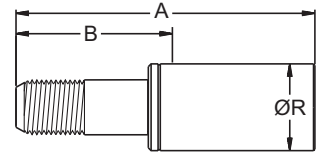

Part Number	Connection Type Thread Size	A Overall Length		B Cutoff Allowance		R Diameter		Maximum Working Pressure	
		inch	mm	inch	mm	inch	mm	psi	MPa
#									
6Y25X-9-8C	9/16" - 18 LH	4.30	109	2.19	56	1.25	32	20,000	137.9
6Y25X-12-8C	3/4" - 16 LH	4.20	107	2.10	53	1.25	32	20,000	137.9

Metric Female Swivel Fitting

C9

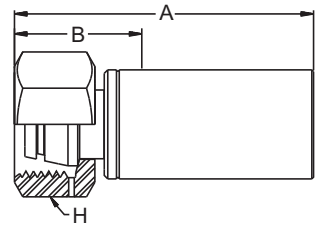

Part Number	Connection Type Thread Size	A Overall Length		B Cutoff Allowance		H Hex Size		Maximum Working Pressure	
		inch	mm	inch	mm	inch	mm	psi	MPa
#									
6C95X-16-8C	M24 x 1.5	3.58	91	1.45	37	1.26	32	20,000	137.9

2640N-12 **polyflex** Hose



Part Number	Jacket Color	Minimum I.D.		Maximum O.D.		Maximum Working Pressure		Minimum Burst Pressure		Minimum Bend Radius		Weight	
		inch	mm	inch	mm	psi	MPa	psi	MPa	inch	mm	lbs/ft	kg/m
#													
2640N-12V32	Blue	0.75	19	1.30	33	20,300	140.0	50,750	350.0	13.77	350	1.41	2.10
2640N-12V71	Black	0.75	19	1.30	33	20,300	140.0	50,750	350.0	13.77	350	1.41	2.10

B

Construction: Polyamide core tube, high strength wire reinforced and a polyamide outer cover.

Temperature Range: -40°F and +140°F (-40°C and +60°C). Contact **polyflex** for temperatures outside this range.

Typical Applications: Flexible, chemical resistant alternative to steel pipe for waterblasting, hydrodemolition, gas transfer, oil field snubbing and hydraulic workover systems, and chemical injection service. The -12V71 is typically used in methanol injection applications.

Type "M" Female Swivel Fitting AY

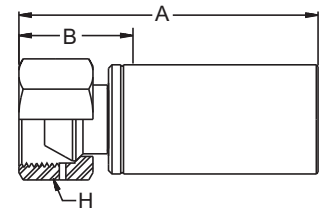

Part Number	Connection Type Thread Size	A Overall Length		B Cutoff Allowance		H Hex Size		Maximum Working Pressure	
		inch	mm	inch	mm	inch	mm	psi	MPa
#									
6AY5X-16-12C	1-5/16" - 12	4.26	108	1.52	39	1.50	38	20,300	140.0
6AY5X-16-12C-SD	1-5/16" - 12	4.26	108	1.52	39	1.50	38	20,300	140.0

*SD = Corrosion Resistant (sea water) — specially designed for aggressive fluids found in offshore drilling applications.

Medium Pressure Tube Nipple

Y2

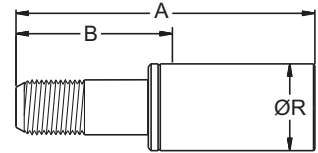

Part Number	Connection Type Thread Size	A Overall Length		B Cutoff Allowance		R Diameter		Maximum Working Pressure	
		inch	mm	inch	mm	inch	mm	psi	MPa
#									
6Y25X-16-12C	1" - 14 LH	5.48	139	2.75	70	1.69	43	20,000	137.9

Metric Female Swivel Fitting

C9

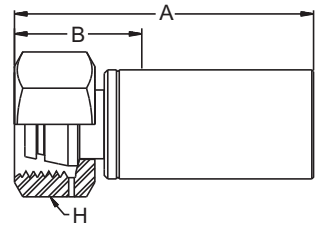

Part Number	Connection Type Thread Size	A Overall Length		B Cutoff Allowance		H Hex Size		Maximum Working Pressure	
		inch	mm	inch	mm	inch	mm	psi	MPa
#									
6C95X-25-12C	M36 x 2	4.37	111	1.60	41	1.81	46	15,000	103.4

2640N-24 **polyflex** Hose **Black Eagle** TC



Part Number	Jacket Color	Minimum I.D.		Maximum O.D.		Maximum Working Pressure		Minimum Burst Pressure		Minimum Bend Radius		Weight	
		inch	mm	inch	mm	psi	MPa	psi	MPa	inch	mm	lbs/ft	kg/m
#													
2640N-24V80	Black	1.50	38	2.80	71	10,000	69.0	33,350	230.0	20.00	508	4.84	7.21

B

Construction: Polyamide core tube, high strength wire reinforced and a polyurethane outer cover.

Temperature Range: -40°F and +140°F (-40°C and +60°C). Contact **polyflex** for temperatures outside this range.

Typical Applications: Flexible, chemical resistant alternative to steel pipe for high volume flow rate pumping offshore, oilfield well service cementing, chemical injection and gas transfer. For use in high pressure hydraulic systems, and as large volume waterblast delivery hose to distribution manifolds for multiple work stations.

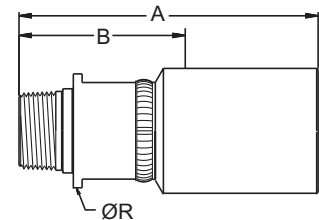

National Pipe Tapered (NPT) Male Fitting 01



Part Number	Connection Type Thread Size	A Overall Length		B Cutoff Allowance		R Diameter		Maximum Working Pressure	
		inch	mm	inch	mm	inch	mm	psi	MPa
#									
6015X-32-24-TC	2" NPT	9.08	231	4.20	107	3.35	85	5,000	34.5

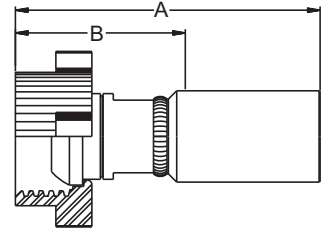

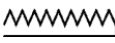
2" Hammer Union (Male) Cone with Wing Nut End Fitting HE

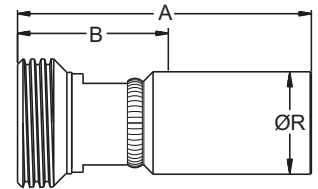

Part Number	Connection Type Thread Size	A Overall Length		B Cutoff Allowance		H Hex Size		Maximum Working Pressure	
		inch	mm	inch	mm	inch	mm	psi	MPa
#									
6HE5X-32-24-TC	4-1/8" - 3 ACME	10.70	272	5.80	147	N/A	N/A	10,000	69.0

2" Hammer Union (Female) Cone, Threaded End with Seal HN



Part Number	Connection Type Thread Size	A Overall Length		B Cutoff Allowance		R Diameter		Maximum Working Pressure	
		inch	mm	inch	mm	inch	mm	psi	MPa
#									
6HN5X-32-24-TC	4-1/8" - 3 ACME	9.15	232	4.25	108	3.35	85	10,000	69.0

2640N-32 **polyflex** Hose **Black Eagle** TC

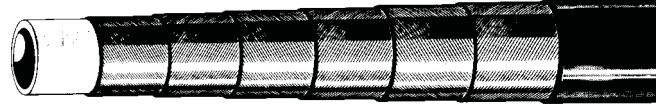

Part Number	Jacket Color	Minimum I.D.		Maximum O.D.		Maximum Working Pressure		Minimum Burst Pressure		Minimum Bend Radius		Weight	
		inch	mm	inch	mm	psi	MPa	psi	MPa	inch	mm	lbs/ft	kg/m
#													
2640N-32V80	Black	2.00	51	3.30	84	10,000	69.0	26,100	180.0	32.00	813	5.70	8.49

Construction: Polyamide core tube, high strength wire reinforced and a polyurethane outer cover.

Temperature Range: -40°F and +140°F (-40°C and +60°C). Contact **polyflex** for temperatures outside this range.

Typical Applications: Flexible, chemical resistant alternative to steel pipe for high volume flow rate pumping offshore, oilfield well service cementing, chemical injection and gas transfer. For use in high pressure hydraulic systems, and as large volume waterblast delivery hose to distribution manifolds for multiple work stations.

National Pipe Tapered (NPT) Male Fitting 01

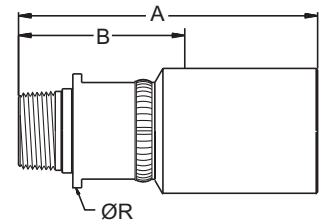



Part Number	Connection Type Thread Size	A Overall Length		B Cutoff Allowance		R Diameter		Maximum Working Pressure	
		inch	mm	inch	mm	inch	mm	psi	MPa
#									
6015X-32-32-TC	2" NPT	10.50	267	4.08	104	3.25	83	5,000	34.5

B

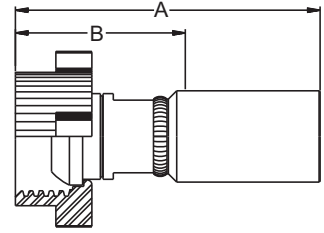

2" Hammer Union (Male) Cone with Wing Nut End Fitting HE

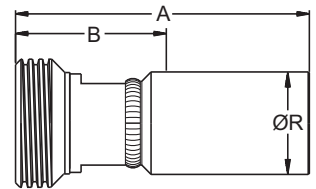

Part Number	Connection Type Thread Size	A Overall Length		B Cutoff Allowance		H Hex Size		Maximum Working Pressure	
		inch	mm	inch	mm	inch	mm	psi	MPa
#									
6HE5X-32-32-TC	4-1/8" - 3 ACME	11.25	286	5.87	149	N/A	N/A	10,000	69.0

2" Hammer Union (Female) Cone, Threaded End with Seal HN

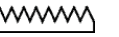

Part Number	Connection Type Thread Size	A Overall Length		B Cutoff Allowance		R Diameter		Maximum Working Pressure	
		inch	mm	inch	mm	inch	mm	psi	MPa
#									
6HN5X-32-32-TC	4-1/8" - 3 ACME	9.50	241	4.12	105	3.88	98	10,000	69.0

2740D-025 **polyflex** Hose



Part Number	Jacket Color	Minimum I.D.		Maximum O.D.		Maximum Working Pressure		Minimum Burst Pressure		Minimum Bend Radius		Weight	
		inch	mm	inch	mm	psi	MPa	psi	MPa	inch	mm	lbs/ft	kg/m
#													
2740D-025V30	Black	0.16	4	0.48	12	45,000	310.3	112,500	775.9	4.75	121	0.21	0.31

Construction: Polyoxymethylene core tube, high strength wire reinforced and a polyamide outer cover.

Temperature Range: -40°F and +140°F (-40°C and +60°C). Contact **polyflex** for temperatures outside this range.

Typical Applications: Small diameter flexible hose, ideal for tight routing applications such as hydraulic tools, and high pressure heat exchanger tube cleaning in petrochemical power plants. Especially suitable for hydraulic pre-tensioning equipment, specialized pressure fitted sleeve and coupling removal equipment. Pressure testing, operations of portable jacks and remote pressure sensing devices.

Type "M" Female Swivel Fitting AY

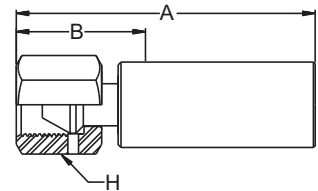

Part Number	Connection Type Thread Size	A Overall Length		B Cutoff Allowance		H Hex Size		Maximum Working Pressure	
		inch	mm	inch	mm	inch	mm	psi	MPa
#									
6AYHX-6-2AC	9/16"-18	3.13	79	1.33	34	0.69	18	45,000	310.3

High Pressure Tube Nipple Y4

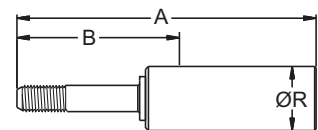



Part Number	Connection Type Thread Size	A Overall Length		B Cutoff Allowance		R Diameter		Maximum Working Pressure	
		inch	mm	inch	mm	inch	mm	psi	MPa
#									
6Y4HX-4-2AC	1/4"-28 LH	3.50	89	1.75	44	0.68	N/A	45,000	310.3
6Y4HX-6-2AC	3/8"-24 LH	3.95	100	2.20	56	0.68	N/A	45,000	310.3

B

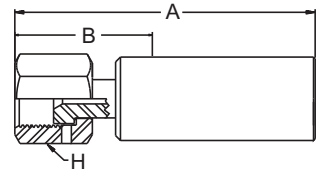
High Pressure Female Swivel Fitting 6Y

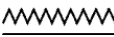

Part Number	Connection Type Thread Size	A Overall Length		B Cutoff Allowance		H Hex Size		Maximum Working Pressure	
		inch	mm	inch	mm	inch	mm	psi	MPa
#									
66YHX-4-2AC	9/16"-18	3.13	79	1.33	34	0.69	18	45,000	310.3

2740D-03 **polyflex** Hose



Part Number	Jacket Color	Minimum I.D.		Maximum O.D.		Maximum Working Pressure		Minimum Burst Pressure		Minimum Bend Radius		Weight	
		inch	mm	inch	mm	psi	MPa	psi	MPa	inch	mm	lbs/ft	kg/m
#													
2740D-03V30	Black	0.20	5	0.52	13	40,600	280.0	101,500	700.0	6.00	152	0.32	0.48

Construction: Polyoxymethylene core tube, high strength wire reinforced and a polyamide outer cover.

Temperature Range: -40°F and +140°F (-40°C and +60°C). Contact **polyflex** for temperatures outside this range.

Typical Applications: Pressure testing and ultra high pressure waterblast lances for high pressure tube cleaning in petrochemical and power plants. Replaces high pressure steel tubing where flexibility and long lengths are important to minimize leak points. Compression forming process (hydroforming) as a manufacturing procedure applying water pressure to produce complex hollow parts made from pipe-like materials for truck and automotive industries.

Type "M" Female Swivel Fitting AY

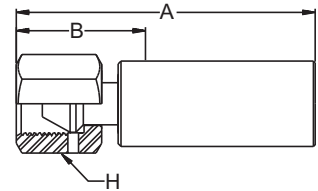

Part Number	Connection Type Thread Size	A Overall Length		B Cutoff Allowance		H Hex Size		Maximum Working Pressure	
		inch	mm	inch	mm	inch	mm	psi	MPa
#									
6AYHX-6-3C	9/16" - 18	3.20	81	1.40	36	0.68	17	40,600	280.0

High Pressure Tube Nipple Y4

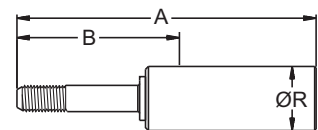



Part Number	Connection Type Thread Size	A Overall Length		B Cutoff Allowance		R Diameter		Maximum Working Pressure	
		inch	mm	inch	mm	inch	mm	psi	MPa
#									
6Y4HX-6-3C	3/8" - 24 LH	4.05	103	2.36	60	0.82	21	40,600	280.0
6Y4HX-9-3C	9/16" - 18 LH	4.42	112	2.70	69	0.82	21	40,600	280.0

B

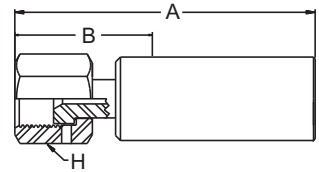

High Pressure Female Swivel Fitting 6Y

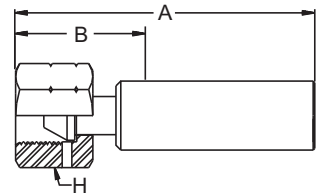

Part Number	Connection Type Thread Size	A Overall Length		B Cutoff Allowance		H Hex Size		Maximum Working Pressure	
		inch	mm	inch	mm	inch	mm	psi	MPa
#									
66YHX-4-3C	9 1/6" - 18	3.20	81	1.40	36	0.68	17	40,600	280.0

BSP Female Swivel Fitting 92

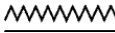

Part Number	Connection Type Thread Size	A Overall Length		B Cutoff Allowance		H Hex Size		Maximum Working Pressure	
		inch	mm	inch	mm	inch	mm	psi	MPa
#									
692HX-4-3C	1/4" BSPP	3.07	78	1.28	33	0.87	22	40,600	280.0

2740D-05 **polyflex** Hose



Part Number	Jacket Color	Minimum I.D.		Maximum O.D.		Maximum Working Pressure		Minimum Burst Pressure		Minimum Bend Radius		Weight	
		inch	mm	inch	mm	psi	MPa	psi	MPa	inch	mm	lbs/ft	kg/m
#													
2740D-05V32	Blue	0.32	8	0.67	17	36,230	249.9	90,580	624.7	7.87	200	0.47	0.70

B

Construction: Polyoxymethylene core tube, high strength wire reinforced and a polyamide outer cover.

Temperature Range: -40°F and +140°F (-40°C and +60°C). Contact **polyflex** for temperatures outside this range.

Typical Applications: Pressure testing and ultra high pressure waterblast delivery hose for industrial cleaning and shipbuilding industries for coatings removal and water jet cutting equipment.

Type "M" Female Swivel Fitting AY

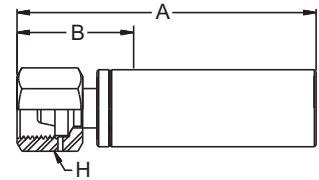

Part Number	Connection Type Thread Size	A Overall Length		B Cutoff Allowance		H Hex Size		Maximum Working Pressure	
		inch	mm	inch	mm	inch	mm	psi	MPa
#									
6AYHX-8-5C	3/4" - 16	2.97	75	1.24	31	1.00	25	30,000	206.9
6AYHX-10-5C	7/8" - 14	3.47	88	1.83	46	1.25	32	36,230	249.9

High Pressure Tube Nipple Y4

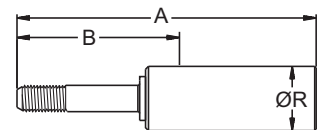

Part Number	Connection Type Thread Size	A Overall Length		B Cutoff Allowance		R Diameter		Maximum Working Pressure	
		inch	mm	inch	mm	inch	mm	psi	MPa
#									
6Y4HX-9-5C	9/16" - 18 LH	4.15	105	2.53	64	1.00	25	36,230	249.9
6Y4HX-9-5C-XLT	9/16" - 18 LH (Long Tube)	5.00	127	3.38	86	1.00	25	36,230	249.9

2840D-03 **polyflex** Hose

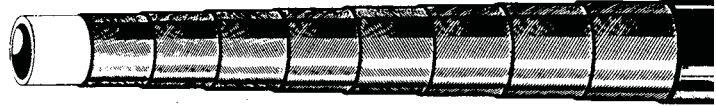

Part Number	Jacket Color	Minimum I.D.		Maximum O.D.		Maximum Working Pressure		Minimum Burst Pressure		Minimum Bend Radius		Weight	
		inch	mm	inch	mm	psi	MPa	psi	MPa	inch	mm	lbs/ft	kg/m
#													
2840D-03V34	Red	0.20	5	0.59	15	48,000	331.0	116,000	800	7.87	200	0.37	0.55
2840D-03V34 *	Red	0.20	5	1.10	28	* 55,000	380.0	116,000	800	7.87	200	1.23	1.83

*With Pressure Containment Shield

Construction: Polyoxymethylene core tube, high strength wire reinforced and a polyamide outer cover.

Temperature Range: -40°F and +140°F (-40°C and +60°C). Contact **polyflex** for temperatures outside this range.

Typical Applications: Ultra high pressure hose used with robotic controlled Waterjet cutting equipment, and coatings removal from marine vessels near or at shipbuilding facilities. Replaces high pressure steel tubing where flexibility and long lengths are important to minimize leak points. Compression forming process (hydroforming) as a manufacturing procedure applying water pressure to produce complex hollow parts made from pipe-like materials for truck and automotive industries.

High Pressure Tube Nipple

Y4

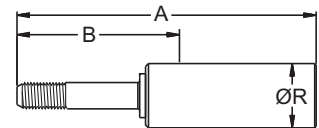

Part Number	Connection Type Thread Size	A Overall Length		B Cutoff Allowance		R Diameter		Maximum Working Pressure	
		inch	mm	inch	mm	inch	mm	psi	MPa
#									
6Y4WX-6-3C	3/8" - 24 LH	4.30	109	2.35	60	0.88	22	55,000	379.3
6Y4WX-9-3C	9/16" - 18 LH	4.42	112	2.50	64	0.88	22	55,000	379.3

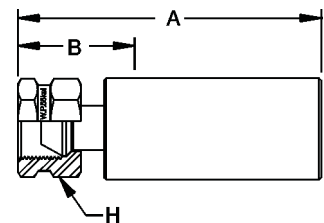

Part Number	Connection Type Thread Size	A Overall Length		B Cutoff Allowance		R Diameter		Maximum Working Pressure	
		inch	mm	inch	mm	inch	mm	psi	MPa
#									
6AYWX-6-3C	9/16" - 18	3.59	91	1.49	38	0.88	22	48,000	331.0
6AYWX-6-3C-55	9/16" - 18	3.59	91	1.49	38	0.88	22	55,000	379.3

2840D-05 polyflex Hose

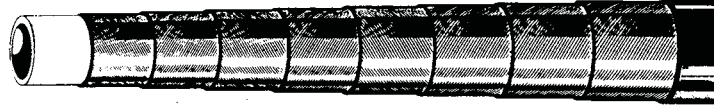

Part Number	Jacket Color	Minimum I.D.		Maximum O.D.		Maximum Working Pressure		Minimum Burst Pressure		Minimum Bend Radius		Weight	
		inch	mm	inch	mm	psi	MPa	psi	MPa	inch	mm	lbs/ft	kg/m
#													
2840D-05V32	Blue	0.32	8	0.78	20	44,000	303.4	101,500	700	9.84	250	0.74	1.10
2840D-05V32 *	Blue	0.32	8	1.40	36	55,000	379.3	101,500	700	9.84	250	0.74	1.10

*With Pressure Containment Shield

Construction: Polyoxymethylene core tube, high strength wire reinforced and a polyamide outer cover.

Temperature Range: -40°F and +140°F (-40°C and +60°C). Contact **polyflex** for temperatures outside this range.

Typical Applications: Ultra high pressure water jet cutting with robotic controlled waterjet cutting equipment, and coatings removal from marine vessels near or at shipbuilding facilities. Replaces high pressure steel tubing where flexibility and long continuous lengths are very important for high volume flow requirements, and to minimize leak points. Compression forming process (hydroforming) as a manufacturing procedure applying water pressure to produce complex hollow parts made from pipe-like materials for truck and automotive industries.

Type "M" Female Swivel Fitting AY

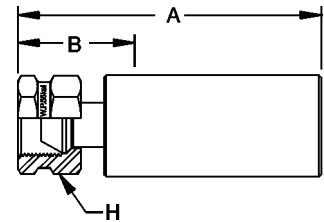

Part Number	Connection Type Thread Size	A Overall Length		B Cutoff Allowance		H Hex Size		Maximum Working Pressure	
		inch	mm	inch	mm	inch	mm	psi	MPa
#									
6AYWX-10-5C	7/8" - 14	4.43	113	1.77	45	1.25	32	44,000	303.4
6AYWX-10-5C-55	7/8" - 14	4.43	113	1.77	45	1.25	32	55,000	379.3

High Pressure Tube Nipple Y4

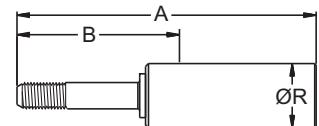

Part Number	Connection Type Thread Size	A Overall Length		B Cutoff Allowance		R Diameter		Maximum Working Pressure	
		inch	mm	inch	mm	inch	mm	psi	MPa
#									
6Y4WX-9-5C	9/16" - 18 LH	5.13	130	2.47	63	1.10	28	44,000	303.4
6Y4WX-9-5C-55	9/16" - 18 LH	5.13	130	2.47	63	1.10	28	55,000	379.3
6Y4WX-9-5C-RCS	9/16" - 18 LH (Long Tube)	5.73	146	3.07	78	1.10	28	44,000	303.4

B

2840D-08 **polyflex** Hose

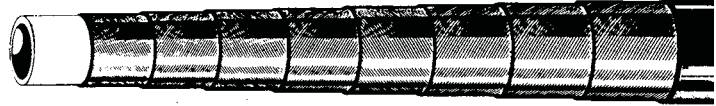

Part Number	Jacket Color	Minimum I.D.		Maximum O.D.		Maximum Working Pressure		Minimum Burst Pressure		Minimum Bend Radius		Weight	
		inch	mm	inch	mm	psi	MPa	psi	MPa	inch	mm	lbs/ft	kg/m
#													
2840D-08V30	Black	0.50	13	1.16	29	36,000	248.3	90,000	620.7	*	*	*	*

*Call for information.

Construction: Polyoxymethylene core tube, high strength wire reinforced and a polyamide outer cover.

Temperature Range: -40°F and +140°F (-40°C and +60°C). Contact **polyflex** for temperatures outside this range.

Typical Applications: Ultra high pressure waterblast delivery hose and high pressure coatings removal. Replaces high pressure steel tubing where flexibility and long single lengths are important to minimize leak points for water jet cutting equipment.

High Pressure Tube Nipple YM

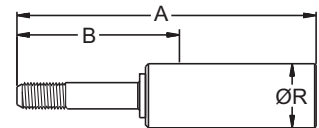

Part Number	Connection Type Thread Size	A Overall Length		B Cutoff Allowance		R Diameter		Maximum Working Pressure	
		inch	mm	inch	mm	inch	mm	psi	MPa
#									
6Y4WX-16-08C	1" - 12 LH	*	*	*	*	*	*	30,000	206.9

*Call for information.

2X90N-04 **polyflex** Hose

“Red Snake”

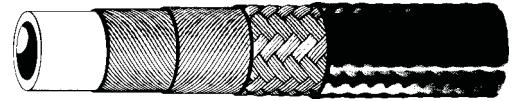

Part Number	Jacket Color	Minimum I.D.		Maximum O.D.		Maximum Working Pressure with 2.5:1		Maximum Working Pressure with 4:1		Minimum Burst Pressure		Minimum Bend Radius		Weight	
		inch	mm	inch	mm	psi	MPa	psi	MPa	psi	MPa	inch	mm	lbs/ft	kg/m
#															
2X90N-04V14	Red	0.25	6	0.53	13	18,560	128.0	11,600	80.0	46,400	320.0	1.57	40	0.19	0.28

B

Construction: Polyamide core tube, steel wire and fiber combination reinforcement with a polyurethane outer cover.

Temperature Range: -40°F and +140°F (-40°C and +60°C). Contact **polyflex** for temperatures outside this range.

Typical Applications: Flexible, lightweight, chemical resistant alternative to rubber hose for waterblast cleaning applications in pulp and paper mills, steel mills, power plants and petrochemical plants. Available in long lengths.

National Pipe Tapered (NPT) Male Fitting

01

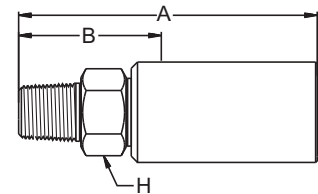

Part Number	Connection Type Thread Size	A Overall Length		B Cutoff Allowance		H Hex Size		Maximum Working Pressure	
		inch	mm	inch	mm	inch	mm	psi	MPa
#									
1018X-6-4	3/8" NPT	2.72	69	1.47	37	0.75	19	15,000	103.4
6018X-4-4	1/4" NPT	2.62	67	1.37	35	0.63	16	15,000	103.4
601LX-4-4C	1/4" NPT	2.62	67	1.37	35	0.63	16	15,000	103.4
601LX-4-4-PL *	1/4" NPT	2.00	67	1.37	35	0.63	16	15,000	103.4

*ProLance® Fitting

Type “M” Female Swivel Fitting

AY

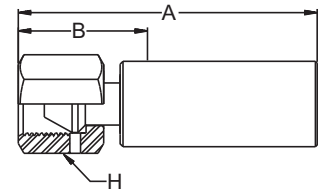

Part Number	Connection Type Thread Size	A Overall Length		B Cutoff Allowance		H Hex Size		Maximum Working Pressure	
		inch	mm	inch	mm	inch	mm	psi	MPa
#									
6AY8X-6-4	9/16" - 18	2.54	65	1.30	33	0.75	19	16,240	112.0
6AYLX-6-4C	9/16" - 18	2.69	68	1.39	35	0.68	17	18,560	128.0
6AYLX-6-4C-SD *	9/16" - 18	2.54	65	1.30	33	0.75	19	18,560	128.0

*SD – Corrosion resistant (sea water)

JIC Female Swivel Fitting

06

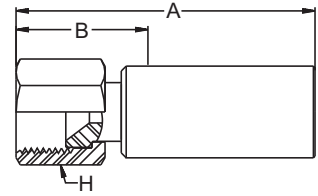

Part Number	Connection Type Thread Size	A Overall Length		B Cutoff Allowance		H Hex Size		Maximum Working Pressure	
		inch	mm	inch	mm	inch	mm	psi	MPa
#									
1068X-4-4	7/16" - 20	2.64	67	1.37	35	0.75	19	10,000	69.0
1068X-6-4	9/16" - 18	2.58	66	1.30	33	0.75	19	10,000	69.0
6069X-4-4C	7/16" - 20	2.24	57	0.98	25	0.63	16	10,000	69.0
6069X-6-4C	9/16" - 18	2.36	60	1.10	28	0.68	17	10,000	69.0

Medium Pressure Female Swivel Fitting

5Y

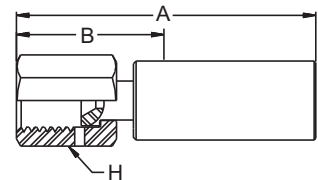

Part Number	Connection Type Thread Size	A Overall Length		B Cutoff Allowance		H Hex Size		Maximum Working Pressure	
		inch	mm	inch	mm	inch	mm	psi	MPa
#									
65Y8X-6-4	9/16" - 18	2.78	71	1.55	39	0.75	19	16,240	112.0
65YLX-6-4C	9/16" - 18	2.84	72	1.54	39	0.75	19	18,560	128.0

BSP Female Swivel Fitting

92

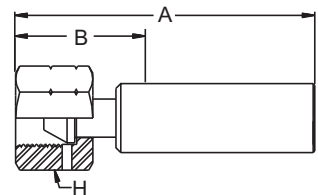

Part Number	Connection Type Thread Size	A Overall Length		B Cutoff Allowance		H Hex Size		Maximum Working Pressure	
		inch	mm	inch	mm	inch	mm	psi	MPa
#									
6928X-4-4	1/4" BSPP	2.51	64	1.27	32	0.75	19	16,240	112.0

BSP Male Fitting

D9

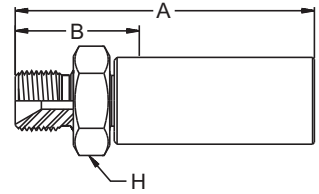

Part Number	Connection Type Thread Size	A Overall Length		B Cutoff Allowance		H Hex Size		Maximum Working Pressure	
		inch	mm	inch	mm	inch	mm	psi	MPa
#									
1D98X-4-4	1/4" BSPP	2.65	67	1.39	35	0.75	19	16,240	112.0

B

Male Stecko Fitting

MB

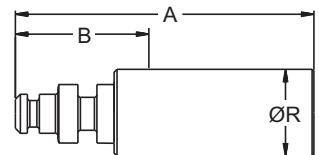

Part Number	Connection Type Thread Size	A Overall Length		B Cutoff Allowance		R Diameter		Maximum Working Pressure	
		inch	mm	inch	mm	inch	mm	psi	MPa
#									
1MB8X-6-4	None	2.85	72	1.58	40	0.86	22	10,000	69.0

Metric Female Swivel Fitting

C3

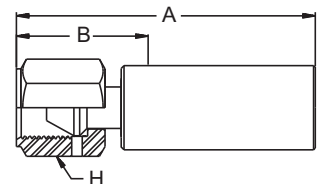

Part Number	Connection Type Thread Size	A Overall Length		B Cutoff Allowance		H Hex Size		Maximum Working Pressure	
		inch	mm	inch	mm	inch	mm	psi	MPa
#									
1C38X-4-4	M14 x 1.5	2.45	62	1.20	30	0.75	19	16,240	112.0

2X90N-06 **polyflex** Hose

“Red Snake”

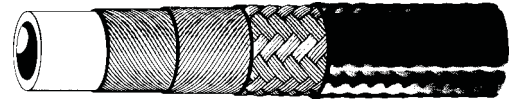

Part Number	Jacket Color	Minimum I.D.		Maximum O.D.		Maximum Working Pressure with 2.5:1		Maximum Working Pressure with 4:1		Minimum Burst Pressure		Minimum Bend Radius		Weight	
		inch	mm	inch	mm	psi	MPa	psi	MPa	psi	MPa	inch	mm	lbs/ft	kg/m
#															
2X90N-06V14	Red	0.40	10	0.85	22	23,200	160.0	15,000	103.4	58,000	400.0	3.75	95	0.63	0.94

Construction: Polyamide core tube, steel wire and fiber combination reinforcement with a polyurethane outer cover.

Temperature Range: -40°F and +140°F (-40°C and +60°C). Contact **polyflex** for temperatures outside this range.

Typical Applications: Flexible, lightweight, chemical resistant alternative to rubber hose for waterblast cleaning applications in pulp and paper mills, steel mills, power plants and petrochemical plants. Available in long lengths.

National Pipe Tapered (NPT) Male Fitting

01

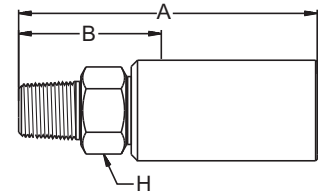

Part Number	Connection Type Thread Size	A Overall Length		B Cutoff Allowance		H Hex Size		Maximum Working Pressure	
		inch	mm	inch	mm	inch	mm	psi	MPa
#									
601RS-6-6	3/8" NPT	3.3	84	1.77	45	0.75	19	15,000	103.4

Metric Female Swivel Fitting

C3

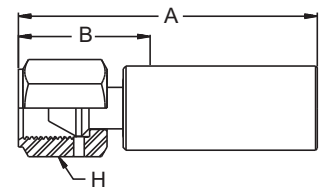

Part Number	Connection Type Thread Size	A Overall Length		B Cutoff Allowance		H Hex Size		Maximum Working Pressure	
		inch	mm	inch	mm	inch	mm	psi	MPa
#									
6C9RS-14-6	M22x1.5	3.3	84	1.77	45	1	25	23,200	160.0

2X90N-08 **polyflex** Hose

“Red Snake”

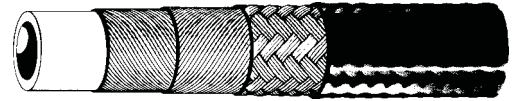

Part Number	Jacket Color	Minimum I.D.		Maximum O.D.		Maximum Working Pressure with 2.5:1		Maximum Working Pressure with 4:1		Minimum Burst Pressure		Minimum Bend Radius		Weight	
		inch	mm	inch	mm	psi	MPa	psi	MPa	psi	MPa	inch	mm	lbs/ft	kg/m
#															
2X90N-08V14	Red	0.50	13	0.91	23	15,080	104.0	9,425	65.0	37,700	260.0	3.15	80	0.45	0.67

Construction: Polyamide core tube, steel wire and fiber combination reinforcement with a polyurethane outer cover.

Temperature Range: -40°F and +140°F (-40°C and +60°C). Contact **polyflex** for temperatures outside this range.

Typical Applications: Flexible, lightweight, chemical resistant alternative to rubber hose for waterblast cleaning applications in pulp and paper mills, steel mills, power plants and petrochemical plants. Available in long lengths.

National Pipe Tapered (NPT) Male Fitting

01

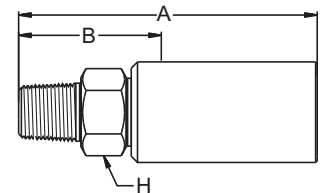

Part Number	Connection Type Thread Size	A Overall Length		B Cutoff Allowance		H Hex Size		Maximum Working Pressure	
		inch	mm	inch	mm	inch	mm	psi	MPa
#									
101RS-8-08	1/2" NPT	3.68	93	1.45	37	0.87	22	15,000	103.4

Metric Female Swivel Fitting

C9

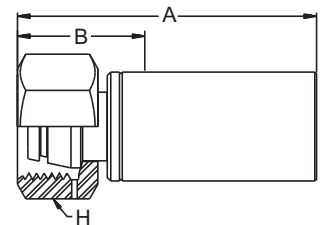

Part Number	Connection Type Thread Size	A Overall Length		B Cutoff Allowance		H Hex Size		Maximum Working Pressure	
		inch	mm	inch	mm	inch	mm	psi	MPa
#									
1C9RS-16-08	M24 x 1.5	3.55	90	1.45	37	1.26	32	15,000	103.4

2X90N-12 **polyflex** Hose “Red Snake”

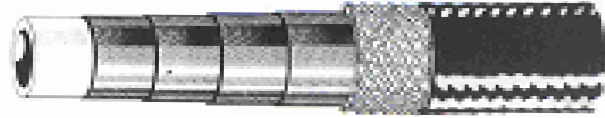

Part Number	Jacket Color	Minimum I.D.		Maximum O.D.		Maximum Working Pressure		Minimum Burst Pressure		Minimum Bend Radius		Weight	
		inch	mm	inch	mm	psi	MPa	psi	MPa	inch	mm	lbs/ft	kg/m
#													
2X90N-12V04	Red	0.81	21	1.30	33	17,400	120.0	43,500	300.0	7.87	200	1.18	1.75

Construction: Polyamide core tube, high strength wire reinforced and a polyamide outer cover.

Temperature Range: -40°F and +140°F (-40°C and +60°C). Contact **polyflex** for temperatures outside this range.

Typical Applications: Flexible, chemical resistant alternative to steel pipe for applications such as water-blasting, hydrodemolition, gas transfer, hydraulic workover and chemical injection. The -12V91 is typically used in Methanol injection applications.

National Pipe Tapered (NPT) Male Fitting 01

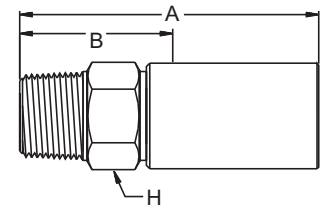

Part Number	Connection Type Thread Size	A Overall Length		B Cutoff Allowance		H Hex Size		Maximum Working Pressure	
		inch	mm	inch	mm	inch	mm	psi	MPa
#									
6015X-12-12C	3/4" NPT	4.98	126	2.23	57	1.38	35	10,000	69.0
6015X-16-12C	1" NPT	4.80	122	2.05	52	1.38	35	10,000	69.0

Type “M” Female Swivel Fitting AY

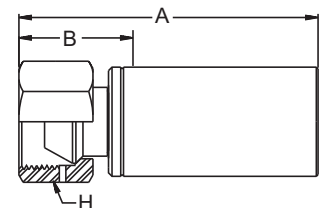

Part Number	Connection Type Thread Size	A Overall Length		B Cutoff Allowance		H Hex Size		Maximum Working Pressure	
		inch	mm	inch	mm	inch	mm	psi	MPa
#									
6AY5X-16-12C	1-5/16" - 12	4.26	108	1.52	39	1.50	38	17,400	120.0

Medium Pressure Tube Nipples

Y2

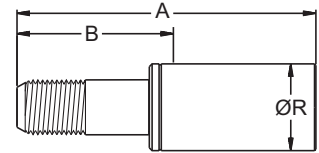

Part Number	Connection Type Thread Size	A Overall Length		B Cutoff Allowance		R Diameter		Maximum Working Pressure	
		inch	mm	inch	mm	inch	mm	psi	MPa
#									
6Y25X-16-12C	1" - 14 LH	5.49	139	2.75	70	1.69	43	17,400	120.0

B

Metric Female Swivel Fitting

C9

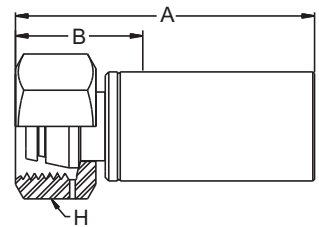

Part Number	Connection Type Thread Size	A Overall Length		B Cutoff Allowance		H Hex Size		Maximum Working Pressure	
		inch	mm	inch	mm	inch	mm	psi	MPa
#									
6C95X-25-12C	M36 x 2	4.16	106	1.58	40	1.81	46	15,000	103.4

JIC Female Swivel Fitting

06

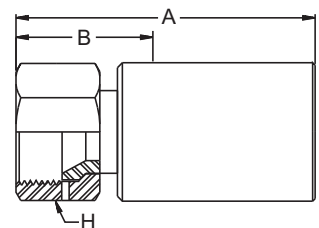

Part Number	Connection Type Thread Size	A Overall Length		B Cutoff Allowance		H Hex Size		Maximum Working Pressure	
		inch	mm	inch	mm	inch	mm	psi	MPa
#									
6065X-16-12C	1-5/16" - 12	4.39	111	1.68	43	1.50	38	10,000	69.0

57CRN **polyflex** Hose

Collapse Resistant

High Pressure U.S. Patents 6,390,141 & 6,742,545



Part Number	Jacket Color	Nominal I.D.		Nominal O.D.		Maximum Working Pressure		Maximum Elongation @ Working Pressure	Minimum Burst Pressure		Minimum Bend Radius		Weight	
		inch	mm	inch	mm	psi	MPa	%	psi	MPa	inch	mm	lbs/ft	kg/m
#														
57CRN-08V02	Blue	0.50	13	1.18	30	5,000	34.5	0 to +4%	20,000	137.9	6.25	159	0.630	0.937
57CRN-08V06	Yellow	0.50	13	1.18	30	5,000	34.5	0 to +4%	20,000	137.9	6.25	159	0.630	0.937
57CRN-16V02	Blue	1.00	25	2.00	51	5,000	34.5	0 to +4%	20,000	137.9	10.75	273	1.460	2.170
57CRN-16V06	Yellow	1.00	25	2.00	51	5,000	34.5	0 to +4%	20,000	137.9	10.75	273	1.460	2.170

* Call for information regarding collapse strength.

Internal impulse requirement: SAE J343; Minimum of 150,000 cycles at 140°F (+60°C) and 5,000 psi (34.5 MPa)

Scope: Specification HS-57CR details the performance of collapse resistant hose for use with high internal pressures. The hose is best suited for offshore oil exploration applications requiring internal pressure resistance and external pressure support. The 57CR series hose offers the ultimate in a lightweight, kink and collapse resistant rugged hose construction.

Construction: The 57CR consists of a polyamide core tube, reinforced with high-tensile strength aramid fiber, and a Patent-Pending stainless steel reinforced helix support. The hose is jacketed, as standard, with a weather and ultra-high abrasion resistant, non-perforated polymeric jacket. The hose suitable for marine hydraulic (salt water) environment.

Typical Applications: Offshore oilfield exploration and production. For use with petroleum, synthetic hydraulic oils, water and water based hydraulic fluids. Hose is not recommended for high pressure pneumatic service applications.

Temperature Range: -40°F and +140°F (-40°C and +60°C). Contact **polyflex** for temperatures outside this range.

Color: Standard is blue. Other colors available upon request.

JIC Female Swivel Fitting

06

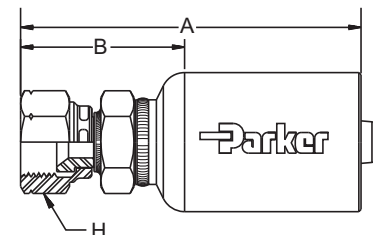

Part Number	Connection Type Thread Size	A Overall Length		B Cutoff Allowance		H Hex Size		Maximum Working Pressure	
		inch	mm	inch	mm	inch	mm	psi	MPa
#									
606CR-8-8C	3/4" - 16	3.875	98	2.125	54	1.000	25	5,000	34.5
606CR-16-16C	1-5/16" - 12	5.000	127	2.750	70	1.625	41	5,000	34.5

HP® – High Pressure Hose

HP8® – High Pressure Non-Conductive Hose

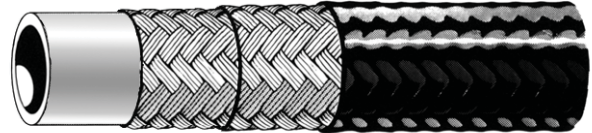

Part No.	Jacket Color	Minimum I.D.		Maximum O.D.		Maximum Working Pressure		Minimum Burst Pressure		Minimum Bend Radius		Weight		Typ. Volume Expansion at Working Pressure		Part No.	Guard Kit Part Number 12 in.	Guard Kit Part Number 23 in.	Crimp Fitting Series
		inch	mm	inch	mm	psi	MPa	psi	MPa	inch	mm	lbs/ft	kg/m	cc/ft.	cc/m				
HP-3	Blue	0.19	5	0.52	13	10,000	69.0	40,000	275.9	1.50	38	.09	0.13	2.4	7.87	HP-3	HPG3-12K	HPG3-23K	HP
HP-4	Blue	0.25	6	0.60	15	10,000	69.0	40,000	275.9	2.50	64	.11	0.16	3.3	10.83	HP-4	HPG4-12K	HPG4-23K	HP
HP-6	Blue	0.38	10	0.74	19	8,000	55.2	32,000	220.7	3.00	76	.16	0.23	4.6	15.09	HP-6	HPG6-12K	HPG6-23K	HP
HP8-3	Orange	0.19	5	0.52	13	10,000	69.0	40,000	275.9	1.50	38	.09	0.13	2.4	7.87	HP8-3	HPG3-12K-ORG	HPG3-23K-ORG	HP
HP8-4	Orange	0.25	6	0.60	15	10,000	69.0	40,000	275.9	2.50	64	.11	0.16	3.3	10.83	HP8-4	HPG4-12K-ORG	HPG4-23K-ORG	HP
HP8-6	Orange	0.38	10	0.74	19	8,000	55.2	32,000	220.7	3.00	76	.16	0.23	4.6	15.09	HP8-6	HPG6-12K-ORG	HPG6-23K-ORG	HP

Meets or exceeds SAE J517 for less than 50 microamps leakage under 75000 volts per foot.

Construction: Specially formulated thermoplastic elastomer core tube, high tensile strength aramid fiber reinforcement. HP8 Hose has an orange non-perforated elastomeric cover.

Applications: High pressure hydraulic, pneumatic and lubricating oils including high pressure tools, rigging jacks, test apparatus, oilfield pressure control devices and offshore oil applications. Non-conductive version used in aerial lift equipment. Not recommended for water blast applications or for use in static discharge applications; i.e., airless paint spray.

Note: The above hose(s) are not intended for use in static discharge applications; i.e., airless paint spray.

Temperature Range: -40°F to +150°F (-40°C to +66°C) for petroleum or synthetic hydraulic fluids, water base fluids and compatible chemicals.

Hose Guards: See page B110.

Fitting Series: HP Series. Field attachable crimp fittings with prior divisional certification.

Refer to HP Hose Assembly Instructions Bulletin No. 4660-B45.



National Pipe Tapered (NPT) Male Fitting

01

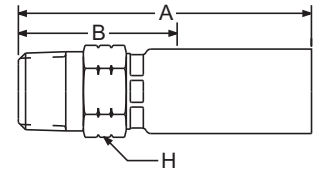

Steel Part No.	NPTF Thread Size	Minimum I.D.		A Overall Length		B Cutoff Allowance		H Hex Size		Pusher Number	Swage Die	Crimp Die
		inch	mm	inch	mm	inch	mm	inch	mm			
#										#		
101HP-2-3	1/8-27	0.19	5	1.94	49	1.19	30	0.56	14	PUM 001	HP3	80C-HP3
101HP-2-4	1/8-27	0.25	6	2.10	53	1.19	30	0.63	16	PUM 002	HP4	80C-HP4
101HP-4-3	1/4-18	0.19	5	2.12	54	1.38	35	0.69	17	PUM 004	HP3	80C-HP3
101HP-4-4	1/4-18	0.25	6	2.28	58	1.38	35	0.69	17	PUM 004	HP4	80C-HP4
101HP-4-6	1/4-18	0.38	10	2.70	69	1.50	38	0.75	19	PUM 005	HP6	80C-HP6
101HP-6-3	3/8-18	0.19	5	2.22	56	1.50	38	0.75	19	PUM 005	HP3	80C-HP3
101HP-6-4	3/8-18	0.25	6	2.38	60	1.38	35	0.75	19	PUM 005	HP4	80C-HP4
101HP-6-6	3/8-18	0.38	10	2.70	69	1.50	38	0.75	19	PUM 005	HP6	80C-HP6
101HP-8-6	1/2-14	0.38	10	2.96	75	1.75	44	0.94	24	PUM 009	HP6	80C-HP6

Note: Some versions of HP Fittings may not allow for use of swage dies. Care should be taken to assure proper use. Consult factory with questions.

JIC Female Swivel Fitting

06

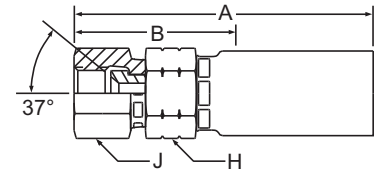

Steel Part No.	NPTF Thread Size	Minimum I.D.		A Overall Length		B Cutoff Allowance		H Hex Size		J Hex Size		Pusher Number	Swage Die	Crimp Die
		inch	mm	inch	mm	inch	mm	inch	mm	inch	mm			
#												#		
106HP-4-3	7/16-20	0.19	5	2.20	56	1.44	37	0.63	16	0.63	16	PUF 011	HP3	80C-HP3
106HP-4-4	7/16-20	0.25	6	2.49	63	1.56	40	0.63	16	0.63	16	PUF 010	HP4	80C-HP4
106HP-5-4	1/2-20	0.25	6	2.52	64	1.56	40	0.75	19	0.75	19	PUF 013	HP4	80C-HP4
106HP-6-4	9/16-18	0.25	6	2.59	66	1.69	43	0.75	19	0.75	19	PUF 015	HP4	80C-HP4
106HP-6-6	9/16-18	0.38	10	2.91	74	1.63	41	0.75	19	0.75	19	PUF 015	HP6	80C-HP6

Note: Some versions of HP Fittings may not allow for use of swage dies. Care should be taken to assure proper use. Consult factory with questions.

High Pressure Safety Guard Kit

Use with Parker HP or HP8 hose only. Each guard kit contains two color coded, pre-assembled 12" or 23" guards, a color coded warning tag, and complete assembly instructions. Use blue guards with HP hose and orange guards with HP8 hose.

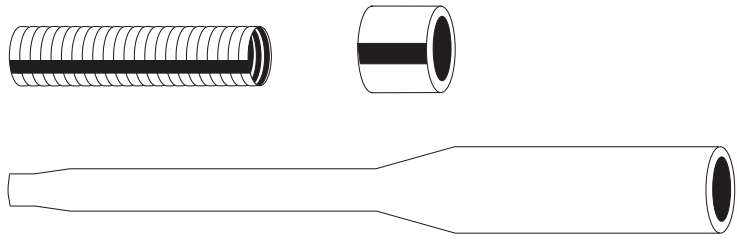

B

Blue Guard Kit Part Number**	Orange Guard Kit Part Number*	Hose Size	Weight Per Guard lbs.	Crimp Die Part Number
#	#			
HPG3-12K	HPG3-12K-ORG	-3	0.27	80C-G03
HPG3-23K	HPG3-23K-ORG	-3	0.37	80C-G03
HPG4-12K	HPG4-12K-ORG	-4	0.32	80C-G04
HPG4-23K	HPG4-23K-ORG	-4	0.42	80C-G04
HPG6-12K	HPG6-12K-ORG	-6	0.40	80C-G06
HPG6-23K	HPG6-23K-ORG	-6	0.52	80C-G06

* For HP8 hose

** For HP hose

2245N-04-D Twin Line **polyflex** Hose

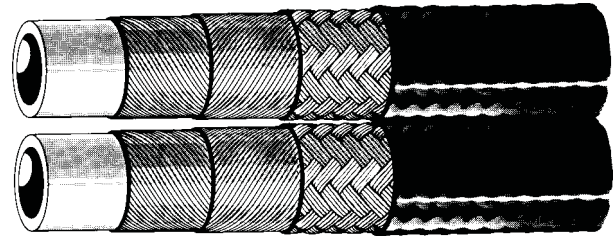

Part Number	Jacket Color	Minimum I.D.		Maximum O.D.		Maximum Working Pressure with 2.5:1		Maximum Working Pressure with 4:1		Minimum Burst Pressure		Minimum Bend Radius		Weight	
		inch	mm	inch	mm	psi	MPa	psi	MPa	psi	MPa	inch	mm	lbs/ft	kg/m
#															
2245N-04V00	Black	0.25	6	0.50	13	10,440	72.0	6,525	45.0	26,100	180.0	2.76	70	0.17	0.25
2245N-04V02	Blue	0.25	6	0.50	13	10,440	72.0	6,525	45.0	26,100	180.0	2.76	70	0.17	0.25
2245N-04V04	Red	0.25	6	0.50	13	10,440	72.0	6,525	45.0	26,100	180.0	2.76	70	0.17	0.25

Construction: Polyamide core tube, high strength wire reinforced and a polyurethane outer cover.

Typical Applications: Industrial equipment, rescue equipment, hydraulic tools.

Assembly includes any combination of two hoses (mix or match 2245N-04-D and 2380N-04-D) with any fitting listed for that hose.

National Pipe Tapered (NPT) Male Fitting 01

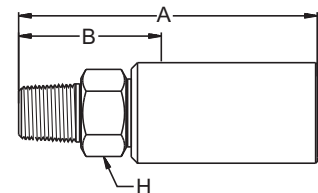

Part Number	Connection Type Thread Size	A Overall Length		B Cutoff Allowance		H Hex Size/ R Diameter		Maximum Working Pressure	
		inch	mm	inch	mm	inch	mm	psi	MPa
#									
101NX-4-4	1/4" NPT	2.57	65	1.35	34	0.63	16	10,400	71.7
101NX-6-4	3/8" NPT	2.63	67	1.38	35	0.75	19	10,400	71.7
601NX-4-4C	1/4" NPT	2.38	60	1.12	28	0.63	16	10,400	71.7

Type "M" Female Swivel Fitting AY

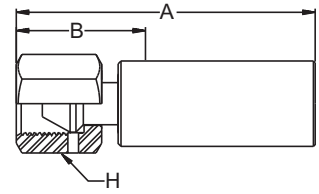

Part Number	Connection Type Thread Size	A Overall Length		B Cutoff Allowance		H Hex Size		Maximum Working Pressure	
		inch	mm	inch	mm	inch	mm	psi	MPa
#									
6AYNX-6-4	9/16" - 18	2.56	65	1.32	34	0.75	19	10,440	72.0
6AYNX-6-4C	9/16" - 18	2.36	60	1.11	28	0.68	17	10,440	72.0

B

JIC Female Swivel Fitting 06

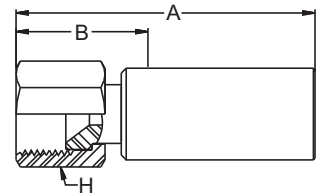

Part Number	Connection Type Thread Size	A Overall Length		B Cutoff Allowance		H Hex Size		Maximum Working Pressure	
		inch	mm	inch	mm	inch	mm	psi	MPa
#									
106NX-4-4	7/16" - 20	2.56	65	1.37	35	0.75	19	10,000	69.0
106NX-6-4	9/16" - 18	2.56	65	1.32	34	0.75	19	10,000	69.0
606NX-4-4C	7/16" - 20	2.23	57	0.99	25	0.63	16	10,000	69.0
606NX-6-4C	9/16" - 18	2.36	60	1.11	28	0.68	17	10,000	69.0

BSP Female Swivel Fitting BC

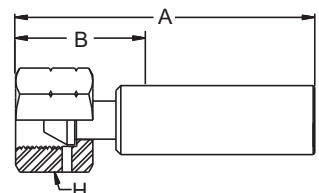



Part Number	Connection Type Thread Size	A Overall Length		B Cutoff Allowance		H Hex Size		Maximum Working Pressure	
		inch	mm	inch	mm	inch	mm	psi	MPa
#									
1BCNX-4-4	1/4" BSPP	2.50	64	1.25	32	0.75	19	10,440	72.0

BSP Male Fitting

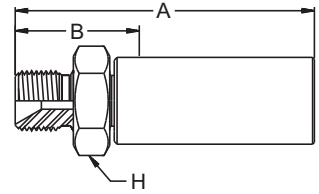
D9

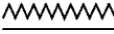



Part Number	Connection Type Thread Size	A Overall Length		B Cutoff Allowance		H Hex Size		Maximum Working Pressure	
		inch	mm	inch	mm	inch	mm	psi	MPa
#									
1D9NX-4-4	1/4" BSPP	2.64	67	1.40	36	0.75	19	10,440	72.0

Metric Female Swivel Fitting

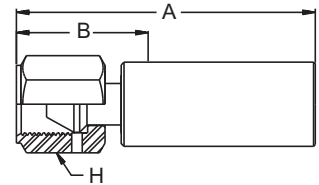
C3



Part Number	Connection Type Thread Size	A Overall Length		B Cutoff Allowance		H Hex Size		Maximum Working Pressure	
		inch	mm	inch	mm	inch	mm	psi	MPa
#									
1C3NX-8-4	M14 x 1.5	2.45	62	1.20	30	0.75	19	10,440	72.0

2380N-04-D Twin Line **polyflex** Hose

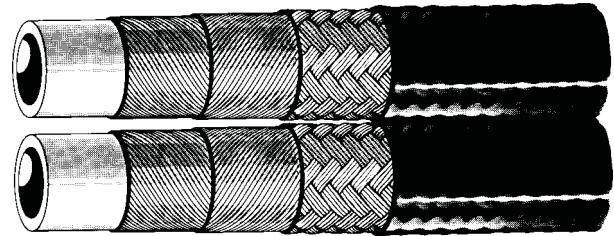

B

Part Number	Jacket Color	Minimum I.D.		Maximum O.D.		Maximum Working Pressure with 2.5:1		Maximum Working Pressure with 4:1		Minimum Burst Pressure		Minimum Bend Radius		Weight	
		inch	mm	inch	mm	psi	MPa	psi	MPa	psi	MPa	inch	mm	lbs/ft	kg/m
#															
2380N-04V00	Black	0.25	6	0.53	13	16,240	112.0	10,150	70.0	40,600	280.0	2.76	70	0.22	0.33
2380N-04V02	Blue	0.25	6	0.53	13	16,240	112.0	10,150	70.0	40,600	280.0	2.76	70	0.22	0.33
2380N-04V04	Red	0.25	6	0.53	13	16,240	112.0	10,150	70.0	40,600	280.0	2.76	70	0.22	0.33

Construction: Polyamide core tube, high strength wire reinforced and a polyurethane outer cover.

Typical Applications: Industrial equipment, rescue equipment, hydraulic tools.

Assembly includes any combination of two hoses (mix or match 2245N-04-D and 2380N-04-D) with any fitting listed for that hose.

National Pipe Tapered (NPT) Male Fitting 01

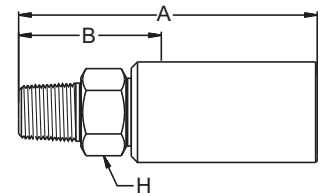

Part Number	Connection Type Thread Size	A Overall Length		B Cutoff Allowance		H Hex Size		Maximum Working Pressure	
		inch	mm	inch	mm	inch	mm	psi	MPa
#									
1018X-6-4	3/8" NPT	2.72	69	1.47	37	0.75	19	15,000	103.4
6018X-4-4	1/4" NPT	2.62	67	1.37	35	0.63	16	15,000	103.4
601LX-4-4C	1/4" NPT	2.62	67	1.37	35	0.63	16	15,000	103.4

Type "M" Female Swivel Fitting AY

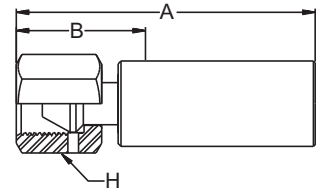

Part Number	Connection Type Thread Size	A Overall Length		B Cutoff Allowance		H Hex Size		Maximum Working Pressure	
		inch	mm	inch	mm	inch	mm	psi	MPa
#									
6AY8X-6-4	9/16" - 18	2.54	65	1.30	33	0.75	19	16,240	112.0
6AYLX-6-4C	9/16" - 18	2.69	68	1.39	35	0.68	17	16,240	112.0
6AYLX-6-4C-SD *	9/16" - 18	2.54	65	1.30	33	0.75	19	16,240	112.0

*SD – Corrosion resistant (sea water)

JIC Female Swivel Fitting 06

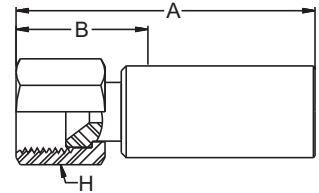

Part Number	Connection Type Thread Size	A Overall Length		B Cutoff Allowance		H Hex Size		Maximum Working Pressure	
		inch	mm	inch	mm	inch	mm	psi	MPa
#									
1068X-4-4	7/16" - 20	2.64	67	1.37	35	0.75	19	10,000	69.0
1068X-6-4	9/16" - 18	2.58	66	1.30	33	0.75	19	10,000	69.0
6069X-4-4C	7/16" - 20	2.24	57	0.98	25	0.63	16	10,000	69.0
6069X-6-4C	9/16" - 18	2.36	60	1.10	28	0.68	17	10,000	69.0

Medium Pressure Female Swivel Fitting 5Y

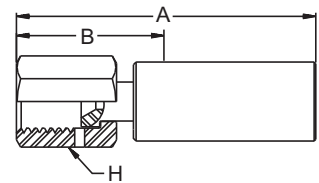

Part Number	Connection Type Thread Size	A Overall Length		B Cutoff Allowance		H Hex Size		Maximum Working Pressure	
		inch	mm	inch	mm	inch	mm	psi	MPa
#									
65Y8X-6-4	9/16" - 18	2.78	71	1.55	39	0.75	19	16,240	112.0
65YLX-6-4C	9/16" - 18	2.84	72	1.54	39	0.75	19	16,240	112.0

BSP Female Swivel Fitting

92

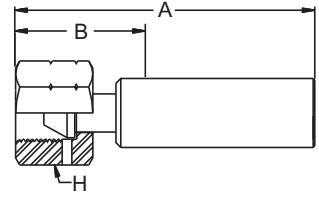

Part Number	Connection Type Thread Size	A Overall Length		B Cutoff Allowance		H Hex Size		Maximum Working Pressure	
		inch	mm	inch	mm	inch	mm	psi	MPa
#									
6928X-4-4	1/4" BSPP	2.51	64	1.27	32	0.75	19	16,240	112.0

B

BSP Male Fitting

D9

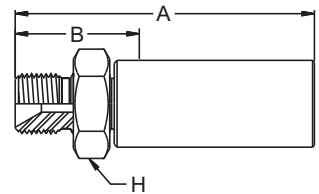

Part Number	Connection Type Thread Size	A Overall Length		B Cutoff Allowance		H Hex Size		Maximum Working Pressure	
		inch	mm	inch	mm	inch	mm	psi	MPa
#									
1D98X-4-4	1/4" BSPP	2.65	67	1.39	35	0.75	19	16,240	112.0

Male Stecko Fitting

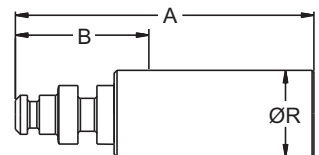

MB

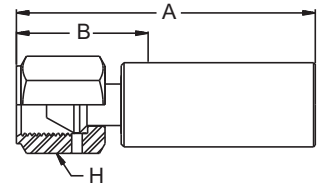

Part Number	Connection Type Thread Size	A Overall Length		B Cutoff Allowance		R Diameter		Maximum Working Pressure	
		inch	mm	inch	mm	inch	mm	psi	MPa
#									
1MB8X-6-4	None	2.85	72	1.58	40	0.86	22	10,000	69.0

Metric Female Swivel Fitting C3

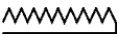

Part Number	Connection Type Thread Size	A Overall Length		B Cutoff Allowance		H Hex Size		Maximum Working Pressure	
		inch	mm	inch	mm	inch	mm	psi	MPa
#									
1C38X-4-4	M14 x 1.5	2.45	62	1.20	30	0.75	19	16,240	112.0

Bundles

Parflex (10,000 psi hose and lower) can be combined with **polyflex** hose (10,000 psi and above) in custom engineered umbilicals, also referred to as hose bundles. Our technical staff will help design a product to meet your specifications and routing requirements. Strength members, tubing, electrical cables, pneumatic lines, and more can be combined with hose, inside of a protective jacket per your custom specifications.

Typical applications include offshore and land-based exploration and drilling operations, hydraulic tool supply lines, medical tools, surface preparation, robotics, construction equipment, and many others.

polyflex's unique manufacturing process can produce very long lengths of steel reinforced thermoplastic hose with very low volumetric expansion characteristics.

High pressure, long lengths, light weight and fast response times are features that account for the success of **polyflex** hose umbilicals.

Contact the division or visit our website with your ideas and requirements.

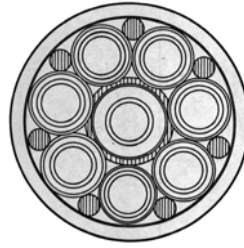

B

Table of Contents

Type M

YAYA.....	C4
YAY6.....	C4
Plugs, caps and torpedos	C5
YAY5.....	C6
YA02.....	C6
YA01.....	C7

20,000 PSI — Medium Pressure

5YY5	C9
5YY6	C10
6YY5	C10
5Y01.....	C11
025Y.....	C12
5Y5Y	C13
5Y6Y	C14
5Y02.....	C15
Y5Y5	C16
Y5Y6	C16
Y501.....	C17
L5Y	C17
T5Y	C18
X5Y	C18
Y2N	C19
Y2C	C19
Plugs	C19
Nipples.....	C19

30,000/60,000 PSI — High Pressure

6YY6	C21
6Y01.....	C21
02Y6.....	C22
Y6Y6	C22
Y601.....	C23
6Y6Y	C23, C24
6Y02.....	C24

30,000/60,000 PSI — High Pressure (Continued)

(Continued)

 Contact Parflex for current price and delivery information on shaded parts.

Table of Contents (Continued)

L6Y	C25
T6Y	C25
X6Y	C25
Y4N	C26
Y4C	C26
HBPHM	C26
Nipples	C26
Locking Nut and Collar	C26
NPT	
Couplers	C27
Elbows	C27
Crosses	C28
Tees	C28
Nipples	C29
Reducer Bushings	C29
Valves — Medium Pressure	
SV5Y	C30
AV5Y	C31
TV25Y	C31
TV15Y	C32
CV5Y	C32
Valves — High Pressure	
SV6Y	C33
AV6Y	C33
TV26Y	C34
TV16Y	C34
SV6Y	C35
AV6Y	C35
TV26Y	C36
TV16Y	C36
CV6Y	C36

Type "M" Swivel Hose Fitting and Adapters

Sizes
Determined by hose type.
9/16" - 18 thd
3/4" - 16 thd
7/8" - 14 thd
1" - 12 thd
1 5/16" - 12 thd

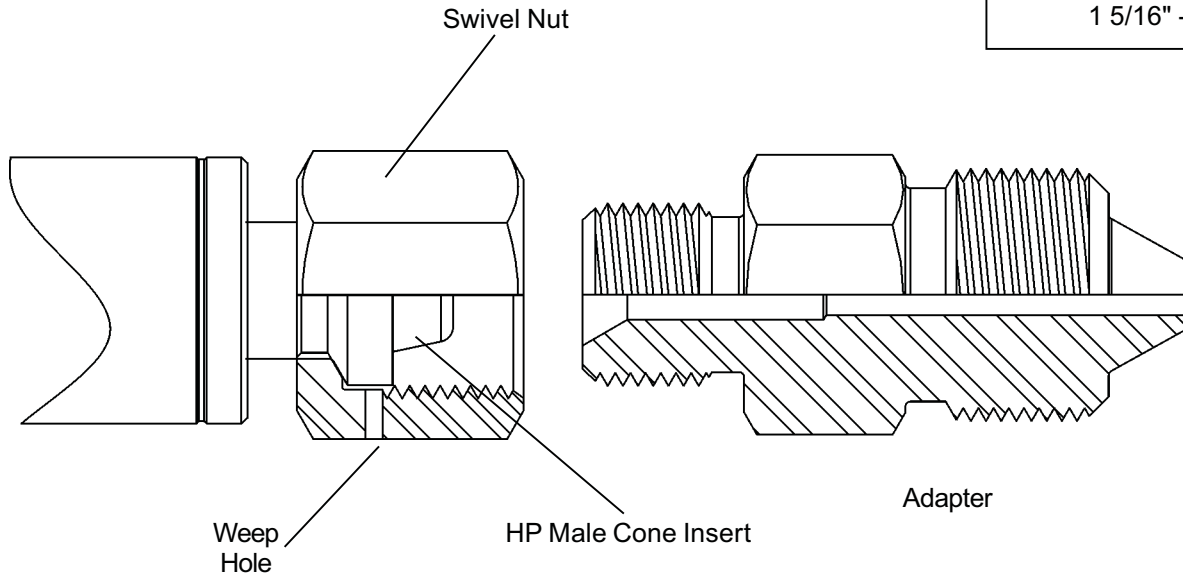

The Type "M" Swivel End Fitting is a swivel nut fitting with a 58° male cone nipple. **Each Type "M" Swivel End Fitting is rated for the full working pressure of the hose.**

Advantages:

- Rated for the full working pressure of hose.
- Provides a swivel for quick and easy connection.
- Internal threads and seal are protected from external damage.
- Non rotating seal reduces galling and minimizes tightening torque.
- Can be adapted to almost any connection required.

YAYA

Type "M" Male x Type "M" Male

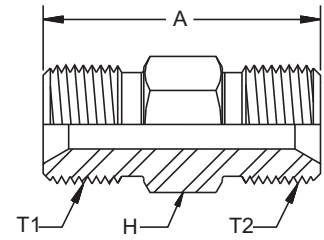

Part Number	Thread Size T1	Thread Size T2	A Overall Length	H Hex Size	Maximum Working Pressure
#					
			inch	inch	psi
YAYA-6-6C	9/16" - 18 UNF	9/16" - 18 UNF	1.38	0.63	60,000
YAYA-8-6C	3/4" - 16 UNF	9/16" - 18 UNF	1.63	0.75	30,000
YAYA-8-8C	3/4" - 16 UNF	3/4" - 16 UNF	1.75	0.75	30,000
YAYA-10-6C	7/8" - 14 UNF	9/16" - 18 UNF	1.88	1.00	60,000
YAYA-10-10C	7/8" - 14 UNF	7/8" - 14 UNF	2.00	1.00	60,000
YAYA-11-8C	1" - 12 UNF	3/4" - 16 UNF	1.88	1.00	30,000
YAYA-11-11C	1" - 12 UNF	1" - 12 UNF	1.88	1.00	30,000
YAYA-16-11C	1-5/16" - 12 UNF	1" - 12 UNF	2.13	1.38	20,000
YAYA-16-16C	1-5/16" - 12 UNF	1-5/16" - 12 UNF	2.13	1.38	20,000

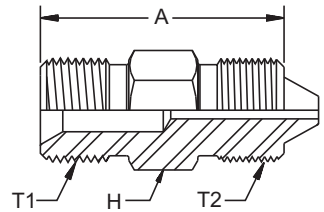

YAY6

Type "M" Male x High Pressure



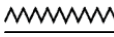

Part Number	Thread Size T1	Thread Size T2	Nom. Tube Size	A Overall Length	H Hex Size	Maximum Working Pressure
#						
				inch	inch	psi
YAY6-6-4C	9/16 - 18 UNF	9/16" - 18 UNF	1/4" HP	1.53	0.63	60,000
YAY6-6-6C	9/16 - 18 UNF	3/4" - 16 UNF	3/8" HP	1.75	0.75	60,000
YAY6-6-9C	9/16 - 18 UNF	1-1/8" - 12 UNF	9/16" HP	2.00	1.13	60,000
YAY6-8-6C	3/4" - 16 UNF	3/4" - 16 UNF	3/8" HP	2.00	0.75	30,000
YAY6-8-9C	3/4" - 16 UNF	1-1/8" - 12 UNF	9/16" HP	2.25	1.13	30,000
YAY6-10-6C	7/8" - 14 UNF	3/4" - 16 UNF	3/8" HP	2.25	1.00	60,000
YAY6-10-9C	7/8" - 14 UNF	1-1/8" - 12 UNF	9/16" HP	2.38	1.13	60,000
YAY6-11-9C	1" - 12 UNF	1-1/8" - 12 UNF	9/16" HP	2.25	1.13	30,000

Plugs

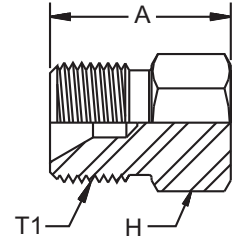
Part Number	Thread Size T1	A Overall Length	H Hex Size	Maximum Working Pressure
#				
		inch	inch	psi
YA6C-PLUG	9/16" - 18	2.07	0.75	60,000
YA8C-PLUG	3/4" - 16	2.13	1.00	30,000
YA11C-PLUG	1" - 12	1.25	1.00	30,000
YA16C-PLUG	1-5/16" - 12	2.63	1.38	20,000



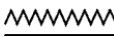

Caps

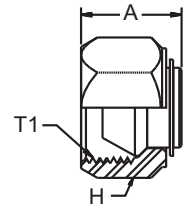
Part Number	Thread Size T1	A Overall Length	H Hex Size	Maximum Working Pressure
#				
		inch	inch	psi
AY6C-CAP	9/16" - 18	0.85	0.69	60,000
AY8C-CAP	3/4" - 16	0.91	1.00	30,000
AY11C-CAP	1" - 12	1.31	1.25	30,000
AY16C-CAP	1-5/16" - 12	1.20	1.50	20,000

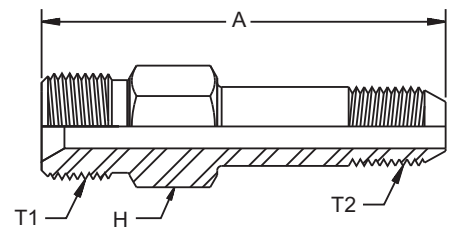

Torpedos

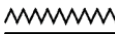
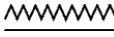

Part Number	Thread Size T1	Thread Size T2	A Overall Length	H Hex Size	Maximum Working Pressure
#					
			inch	inch	psi
YAY1-8-16C	3/4" - 16	1" - 14 LH	3.56	1.13	20,000
YAY2-8-16C	3/4" - 16	1" - 14 LH	3.56	1.38	20,000
YAY1-11-16C	1" - 12	1" - 14 LH	3.56	1.13	20,000
YAY2-11-16C	1" - 12	1" - 14 LH	3.56	1.38	20,000
YAY1-16-16C	1-5/16" - 12	1" - 14 LH	3.70	1.38	20,000
YAY2-16-16C	1-5/16" - 12	1" - 14 LH	3.70	1.38	20,000

YAY5

Type "M" Male x Medium Pressure

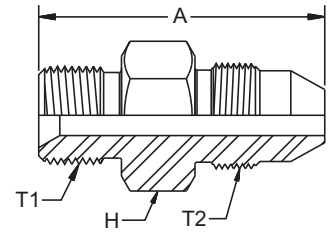

Part Number	Thread Size T1	Thread Size T2	Nom. Tube Size	A Overall Length	H Hex Size	Maximum Working Pressure
#						
				inch	inch	psi
YAY5-6-4C	9/16" - 18 UNF	7/16" - 20 UNF	1/4" MP	1.56	0.63	20,000
YAY5-6-6C	9/16" - 18 UNF	9/16" - 18 UNF	3/8" MP	1.63	0.63	20,000
YAY5-6-9C	9/16" - 18 UNF	13/16" - 16 UNF	9/16" MP	2.00	0.88	20,000
YAY5-6-12C	9/16" - 18 UNF	3/4" - 14 NPS	3/4" MP	2.32	1.13	20,000
YAY5-8-6C	3/4" - 16 UNF	9/16" - 18 UNF	3/8" MP	1.88	0.75	20,000
YAY5-8-9C	3/4" - 16 UNF	13/16" - 16 UNF	9/16" MP	2.20	0.88	20,000
YAY5-8-12C	3/4" - 16 UNF	3/4" - 14 NPS	3/4" MP	2.44	1.13	20,000
YAY5-11-6C	1" - 12 UNF	9/16" - 18 UNF	3/8" MP	2.00	1.00	20,000
YAY5-11-9C	1" - 12 UNF	13/16" - 16 UNF	9/16" MP	2.25	1.00	20,000
YAY5-11-12C	1" - 12 UNF	3/4" - 14 NPS	3/4" MP	2.44	1.13	20,000
YAY5-16-9C	1-5/16" - 12 UNF	9/16" - 18 UNF	9/16" MP	2.50	1.38	20,000
YAY5-16-12C	1-5/16" - 12 UNF	13/16" - 16 UNF	3/4" MP	2.70	1.38	20,000

YA02

Type "M" Male x National Pipe Thread (NPT) Female

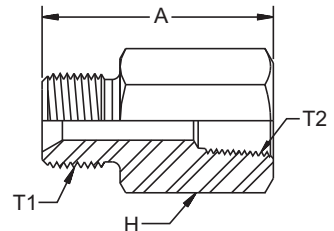



Part Number	Thread Size T1	Thread Size T2	A Overall Length	H Hex Size	Maximum Working Pressure
#					
			inch	inch	psi
YA02-6-4C	9/16" - 18 UNF	1/4" - 18 NPT	1.50	0.75	15,000
YA02-6-8C	9/16" - 18 UNF	1/2" - 14 NPT	2.00	1.25	15,000
YA02-8-8C	3/4" - 16 UNF	1/2" - 14 NPT	2.00	1.25	15,000
YA02-11-8C	1" - 12 UNF	1/2" - 14 NPT	2.50	1.00	15,000

YA01

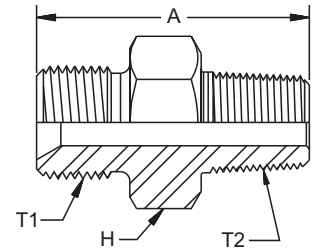
Type "M" Male x National Pipe Thread (NPT) Male

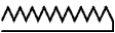
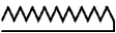

Part Number	Thread Size T1	Thread Size T2	A Overall Length	H Hex Size	Maximum Working Pressure
#					
			inch	inch	psi
YA01-6-2C	9/16 - 18 UNF	1/8" - 27 NPT	1.28	0.63	15,000
YA01-6-4C	9/16 - 18 UNF	1/4" - 18 NPT	1.38	0.63	15,000
YA01-6-6C	9/16 - 18 UNF	3/8" - 18 NPT	1.57	0.75	15,000
YA01-6-8C	9/16 - 18 UNF	1/2" - 14 NPT	1.75	0.88	15,000
YA01-8-4C	3/4" - 16 UNF	1/4" - 18 NPT	1.80	0.75	15,000
YA01-8-6C	3/4" - 16 UNF	3/8" - 18 NPT	1.73	0.75	15,000
YA01-8-8C	3/4" - 16 UNF	1/2" - 14 NPT	1.95	0.88	15,000
YA01-8-12C	3/4" - 16 UNF	3/4" - 12 NPT	2.13	1.13	10,000
YA01-8-16C	3/4" - 16 UNF	1" - 11-1/2 NPT	2.38	1.38	10,000
YA01-11-6C	1" - 12 UNF	3/8" - 18 NPT	1.85	1.00	15,000
YA01-11-8C	1" - 12 UNF	1/2" - 14 NPT	2.00	1.00	15,000
YA01-11-12C	1" - 12 UNF	3/4" - 12 NPT	2.13	1.13	10,000
YA01-11-16C	1" - 12 UNF	1" - 11-1/2 NPT	2.38	1.38	10,000
YA01-16-8C	1-5/16" - 12 UNF	1/2" - 14 NPT	2.13	1.38	15,000
YA01-16-12C	1-5/16" - 12 UNF	3/4" - 12 NPT	2.38	1.38	10,000
YA01-16-16C	1-5/16" - 12 UNF	1" - 11-1/2 NPT	2.50	1.38	10,000
YA01-16-20C	1-5/16" - 12 UNF	1-1/4" - 11-1/2 NPT	2.75	1.75	10,000
YA01-16-24C	1-5/16" - 12 UNF	1-1/2" - 11-1/2 NPT	2.75	2.00	10,000
YA01-16-32C	1-5/16" - 12 UNF	2" - 11-1/2 NPT	2.75	2.38	10,000



Medium Pressure

Sizes

1/4" O.D. x 0.109" I.D. • 7/16" - 20 male thread on gland nut
3/8" O.D. x 0.19" I.D. • 9/16" - 18 male thread on gland nut
9/16" O.D. x 0.31" I.D. • 13/16" - 16 male thread on gland nut
3/4" O.D. x 0.44" I.D. • 3/4" - National Pipe Straight male
1" O.D. x 0.56" I.D. • 1-3/8" - 12 male thread on gland nut

Identification is by tubing O.D.

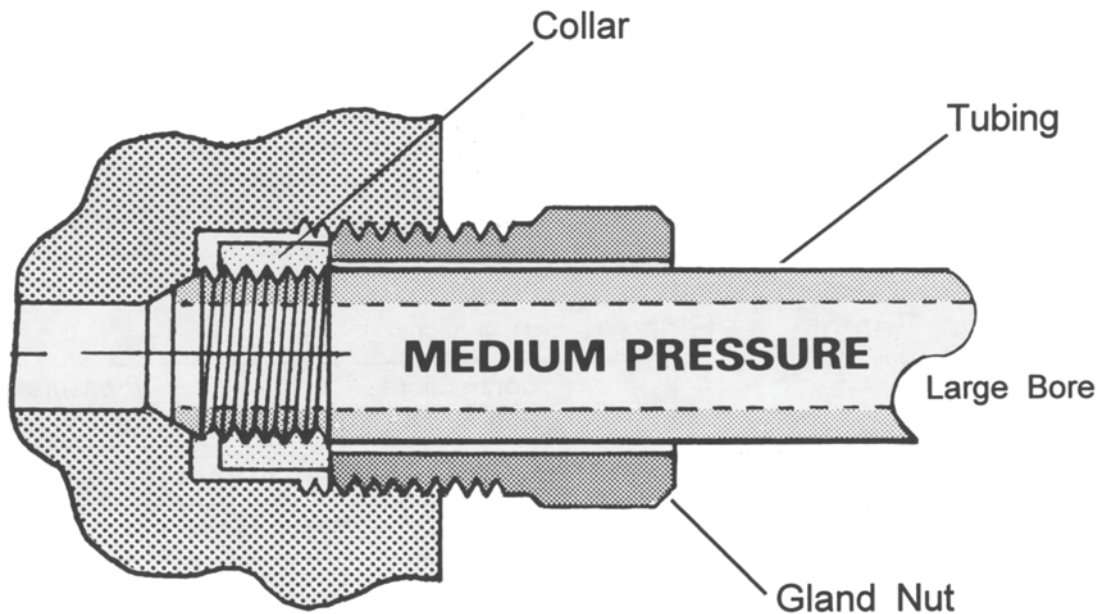

Medium Pressure is a 58/60 degree coned and threaded tubing design. *They have a maximum working pressure rating of 20,000 psi.*



Advantages:

- An industry standard for use at elevated pressures.
- Large orifice allows maximum flow of liquids and gases.
- Suitable for repetitive assembly and disassembly.

5YY5

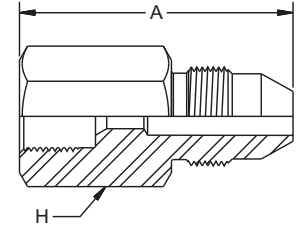
Female Medium Pressure to Male Medium Pressure



Part Number	Connection Type	A Overall Length	H Hex Size	Maximum Working Pressure
#				
		inch	inch	psi
5YY5-4-6C	1/4" M.P. Female to 3/8" M.P. Male	1.75	0.75	20,000
5YY5-4-9C	1/4" M.P. Female to 9/16" M.P. Male	1.87	0.87	20,000
5YY5-4-12C	1/4" M.P. Female to 3/4" M.P. Male	2.00	1.12	20,000
5YY5-4-16C	1/4" M.P. Female to 1" M.P. Male	3.00	1.00	20,000
5YY5-6-4C	3/8" M.P. Female to 1/4" M.P. Male	1.75	0.75	20,000
5YY5-6-9C	3/8" M.P. Female to 9/16" M.P. Male	1.87	0.87	20,000
5YY5-6-12C	3/8" M.P. Female to 3/4" M.P. Male	2.00	1.12	20,000
5YY5-6-16C	3/8" M.P. Female to 1" M.P. Male	3.12	1.00	20,000
5YY5-9-4C	9/16" M.P. Female to 1/4" M.P. Male	2.12	1.00	20,000
5YY5-9-6C	9/16" M.P. Female to 3/8" M.P. Male	2.12	1.00	20,000
5YY5-9-12C	9/16" M.P. Female to 3/4" M.P. Male	2.50	1.12	20,000
5YY5-9-16C	9/16" M.P. Female to 1" M.P. Male	3.37	1.00	20,000
5YY5-12-4C	3/4" M.P. Female to 1/4" M.P. Male	1.25	1.37	20,000
5YY5-12-6C	3/4" M.P. Female to 3/8" M.P. Male	2.37	1.37	20,000
5YY5-12-9C	3/4" M.P. Female to 9/16" M.P. Male	2.87	1.37	20,000
5YY5-12-16C	3/4" M.P. Female to 1" M.P. Male	3.75	1.37	20,000
5YY5-16-4C	1" M.P. Female to 1/4" M.P. Male	2.75	1.75	20,000
5YY5-16-6C	1" M.P. Female to 3/8" M.P. Male	2.87	1.75	20,000
5YY5-16-9C	1" M.P. Female to 9/16" M.P. Male	3.00	1.75	20,000
5YY5-16-12C	1" M.P. Female to 3/4" M.P. Male	3.25	1.75	20,000



5YY6

Female Medium Pressure to Male High Pressure

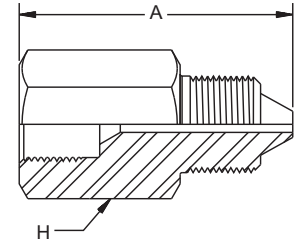

Part Number	Connection Type	A Overall Length	H Hex Size	Maximum Working Pressure
#				
		inch	inch	psi
5YY6-4-4C	1/4" M.P. Female to 1/4" H.P. Male	1.37	0.75	20,000
5YY6-4-6C	1/4" M.P. Female to 3/8" H.P. Male	1.75	0.75	20,000
5YY6-4-9C	1/4" M.P. Female to 9/16" H.P. Male	2.12	1.12	20,000
5YY6-6-4C	3/8" M.P. Female to 1/4" H.P. Male	1.75	0.75	20,000
5YY6-6-6C	3/8" M.P. Female to 3/8" H.P. Male	1.75	0.75	20,000
5YY6-6-9C	3/8" M.P. Female to 9/16" H.P. Male	2.12	1.12	20,000
5YY6-9-4C	9/16" M.P. Female to 1/4" H.P. Male	1.87	1.00	20,000
5YY6-9-6C	9/16" M.P. Female to 3/8" H.P. Male	2.12	1.00	20,000
5YY6-9-9C	9/16" M.P. Female to 9/16" H.P. Male	2.12	1.12	20,000
5YY6-12-4C	3/4" M.P. Female to 1/4" H.P. Male	2.50	1.37	20,000
5YY6-12-6C	3/4" M.P. Female to 3/8" H.P. Male	2.37	1.37	20,000
5YY6-12-9C	3/4" M.P. Female to 9/16" H.P. Male	2.62	1.37	20,000
5YY6-16-4C	1" M.P. Female to 1/4" H.P. Male	2.62	1.75	20,000
5YY6-16-6C	1" M.P. Female to 3/8" H.P. Male	2.87	1.75	20,000
5YY6-16-9C	1" M.P. Female to 9/16" H.P. Male	3.12	1.75	20,000

6YY5

Female High Pressure to Male Medium Pressure

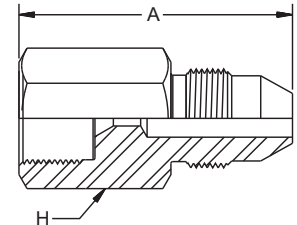

Part Number	Connection Type	A Overall Length	H Hex Size	Maximum Working Pressure
#				
		inch	inch	psi
6YY5-4-4C	1/4" H.P. Female to 1/4" M.P. Male	1.75	0.75	20,000
6YY5-4-6C	1/4" H.P. Female to 3/8" M.P. Male	1.75	0.75	20,000
6YY5-4-9C	1/4" H.P. Female to 9/16" M.P. Male	1.87	0.87	20,000
6YY5-4-12C	1/4" H.P. Female to 3/4" M.P. Male	2.25	1.12	20,000
6YY5-4-16C	1/4" H.P. Female to 1" M.P. Male	3.00	1.00	20,000
6YY5-6-4C	3/8" H.P. Female to 1/4" M.P. Male	1.87	1.00	20,000
6YY5-6-6C	3/8" H.P. Female to 3/8" M.P. Male	1.87	1.00	20,000
6YY5-6-9C	3/8" H.P. Female to 9/16" M.P. Male	2.00	1.00	20,000
6YY5-6-12C	3/8" H.P. Female to 3/4" M.P. Male	2.25	1.12	20,000
6YY5-6-16C	3/8" H.P. Female to 1" M.P. Male	3.25	1.00	20,000
6YY5-9-4C	9/16" H.P. Female to 1/4" M.P. Male	2.12	1.37	20,000
6YY5-9-6C	9/16" H.P. Female to 3/8" M.P. Male	2.12	1.37	20,000
6YY5-9-9C	9/16" H.P. Female to 9/16" M.P. Male	2.37	1.37	20,000
6YY5-9-12C	9/16" H.P. Female to 3/4" M.P. Male	2.50	1.37	20,000
6YY5-9-16C	9/16" H.P. Female to 1" M.P. Male	3.62	1.37	20,000

5Y01

Female Medium Pressure to National Pipe Thread (NPT) Male

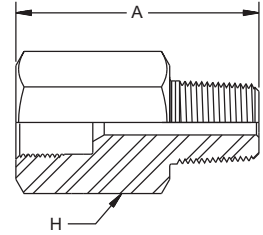

Part Number	Connection Type	A Overall Length	H Hex Size	Maximum Working Pressure
#				
		inch	inch	psi
5Y01-4-2C	1/4" M.P. Female to 1/8" NPT Male	1.43	0.75	15,000
5Y01-4-4C	1/4" M.P. Female to 1/4" NPT Male	1.62	0.75	15,000
5Y01-4-6C	1/4" M.P. Female to 3/8" NPT Male	1.62	0.75	15,000
5Y01-4-8C	1/4" M.P. Female to 1/2" NPT Male	1.75	1.00	15,000
5Y01-4-12C	1/4" M.P. Female to 3/4" NPT Male	1.87	1.37	10,000
5Y01-4-16C	1/4" M.P. Female to 1" NPT Male	1.87	1.37	10,000
5Y01-6-2C	3/8" M.P. Female to 1/8" NPT Male	1.43	0.75	15,000
5Y01-6-4C	3/8" M.P. Female to 1/4" NPT Male	1.62	0.75	15,000
5Y01-6-6C	3/8" M.P. Female to 3/8" NPT Male	1.62	0.75	15,000
5Y01-6-8C	3/8" M.P. Female to 1/2" NPT Male	1.74	1.00	15,000
5Y01-6-12C	3/8" M.P. Female to 3/4" NPT Male	1.87	1.37	10,000
5Y01-6-16C	3/8" M.P. Female to 1" NPT Male	1.87	1.37	10,000
5Y01-9-2C	9/16" M.P. Female to 1/8" NPT Male	1.87	1.00	15,000
5Y01-9-4C	9/16" M.P. Female to 1/4" NPT Male	1.87	1.00	15,000
5Y01-9-6C	9/16" M.P. Female to 3/8" NPT Male	1.87	1.00	15,000
5Y01-9-8C	9/16" M.P. Female to 1/2" NPT Male	1.87	1.00	15,000
5Y01-9-12C	9/16" M.P. Female to 3/4" NPT Male	1.87	1.37	10,000
5Y01-9-16C	9/16" M.P. Female to 1" NPT Male	1.87	1.37	10,000
5Y01-12-2C	3/4" M.P. Female to 1/8" NPT Male	2.50	1.37	15,000
5Y01-12-4C	3/4" M.P. Female to 1/4" NPT Male	2.50	1.37	15,000
5Y01-12-6C	3/4" M.P. Female to 3/8" NPT Male	2.50	1.37	15,000
5Y01-12-8C	3/4" M.P. Female to 1/2" NPT Male	2.50	1.37	15,000
5Y01-12-12C	3/4" M.P. Female to 3/4" NPT Male	2.50	1.37	15,000
5Y01-12-16C	3/4" M.P. Female to 1" NPT Male	2.50	1.37	15,000
5Y01-16-2C	1" M.P. Female to 1/8" NPT Male	2.50	1.37	15,000
5Y01-16-4C	1" M.P. Female to 1/4" NPT Male	2.50	1.37	15,000
5Y01-16-6C	1" M.P. Female to 3/8" NPT Male	2.50	1.37	15,000
5Y01-16-8C	1" M.P. Female to 1/2" NPT Male	2.50	1.37	15,000
5Y01-16-12C	1" M.P. Female to 3/4" NPT Male	2.50	1.37	15,000
5Y01-16-16C	1" M.P. Female to 1" NPT Male	2.50	1.37	10,000

C

02Y5

Female NPT to Male Medium Pressure

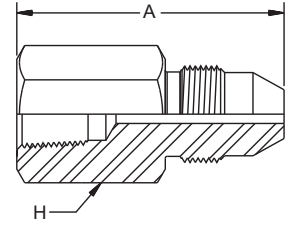

Part Number	Connection Type	A Overall Length	H Hex Size	Maximum Working Pressure
#				
		inch	inch	psi
02Y5-2-12C	1/8" NPT Female to 3/4" M.P. Male	2.00	1.12	15,000
02Y5-2-16C	1/8" NPT Female to 1" M.P. Male	3.00	1.00	15,000
02Y5-2-4C	1/8" NPT Female to 1/4" M.P. Male	1.75	0.75	15,000
02Y5-2-6C	1/8" NPT Female to 3/8" M.P. Male	1.87	0.75	15,000
02Y5-2-9C	1/8" NPT Female to 9/16" M.P. Male	1.87	0.87	15,000
02Y5-4-4C	1/4" NPT Female to 1/4" M.P. Male	1.75	0.75	15,000
02Y5-4-6C	1/4" NPT Female to 3/8" M.P. Male	1.87	0.75	15,000
02Y5-4-9C	1/4" NPT Female to 9/16" M.P. Male	1.87	0.87	15,000
02Y5-4-12C	1/4" NPT Female to 3/4" M.P. Male	2.00	1.12	15,000
02Y5-4-16C	1/4" NPT Female to 1" M.P. Male	3.00	1.00	15,000
02Y5-6-4C	3/8" NPT Female to 1/4" M.P. Male	2.00	1.00	15,000
02Y5-6-6C	3/8" NPT Female to 3/8" M.P. Male	2.12	1.00	15,000
02Y5-6-9C	3/8" NPT Female to 9/16" M.P. Male	2.25	1.00	15,000
02Y5-6-12C	3/8" NPT Female to 3/4" M.P. Male	2.00	1.12	15,000
02Y5-6-16C	3/8" NPT Female to 1" M.P. Male	3.00	1.00	15,000
02Y5-8-4C	1/2" NPT Female to 1/4" M.P. Male	2.12	1.12	15,000
02Y5-8-6C	1/2" NPT Female to 3/8" M.P. Male	1.25	1.12	15,000
02Y5-8-9C	1/2" NPT Female to 9/16" M.P. Male	2.37	1.12	15,000
02Y5-8-12C	1/2" NPT Female to 3/4" M.P. Male	2.50	1.12	15,000
02Y5-8-16C	1/2" NPT Female to 1" M.P. Male	3.75	1.12	15,000
02Y5-12-4C	3/4" NPT Female to 1/4" M.P. Male	2.37	1.37	10,000
02Y5-12-6C	3/4" NPT Female to 3/8" M.P. Male	2.50	1.37	10,000
02Y5-12-9C	3/4" NPT Female to 9/16" M.P. Male	2.62	1.37	10,000
02Y5-12-12C	3/4" NPT Female to 3/4" M.P. Male	2.75	1.50	10,000
02Y5-12-16C	3/4" NPT Female to 1" M.P. Male	4.12	1.50	10,000
02Y5-16-6C	1" NPT Female to 3/8" M.P. Male	2.87	1.87	10,000
02Y5-16-9C	1" NPT Female to 9/16" M.P. Male	3.00	1.87	10,000
02Y5-16-12C	1" NPT Female to 3/4" M.P. Male	3.00	1.87	10,000
02Y5-16-16C	1" NPT Female to 1" M.P. Male	4.37	1.87	10,000

5Y5Y Straight Coupling

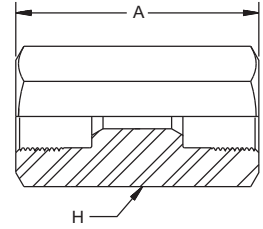

Part Number	Connection Type	A Overall Length	H Hex Size	Maximum Working Pressure
#				
		inch	inch	psi
5Y5Y-4-4C	1/4" Medium Pressure Female	1.62	0.75	20,000
5Y5Y-6-6C	3/8" Medium Pressure Female	1.75	0.75	20,000
5Y5Y-9-9C	9/16" Medium Pressure Female	2.12	1.00	20,000
5Y5Y-12-12C	3/4" Medium Pressure Female	2.50	1.37	20,000
5Y5Y-16-16C	1" Medium Pressure Female	3.50	1.75	20,000



5Y5Y Reducer Coupling

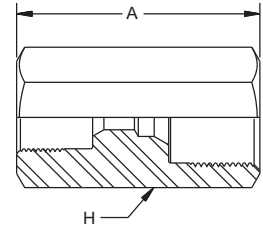

Part Number	Connection Type	A Overall Length	H Hex Size	Maximum Working Pressure
#				
		inch	inch	psi
5Y5Y-4-6C	1/4" M.P. Female to 3/8" M.P. Female	1.75	0.75	20,000
5Y5Y-4-9C	1/4" M.P. Female to 9/16" M.P. Female	2.12	1.00	20,000
5Y5Y-4-12C	1/4" M.P. Female to 3/4" M.P. Female	2.50	1.37	20,000
5Y5Y-4-16C	1/4" M.P. Female to 1" M.P. Female	3.50	1.75	20,000
5Y5Y-6-9C	3/8" M.P. Female to 9/16" M.P. Female	2.12	1.00	20,000
5Y5Y-6-12C	3/8" M.P. Female to 3/4" M.P. Female	2.50	1.37	20,000
5Y5Y-6-16C	3/8" M.P. Female to 1" M.P. Female	3.50	1.75	20,000
5Y5Y-9-12C	9/16" M.P. Female to 3/4" M.P. Female	2.50	1.37	20,000
5Y5Y-9-16C	9/16" M.P. Female to 1" M.P. Female	3.50	1.75	20,000
5Y5Y-12-16C	3/4" M.P. Female to 1" M.P. Female	3.50	1.75	20,000

5Y6Y

Medium Pressure Female to High Pressure Female Coupling

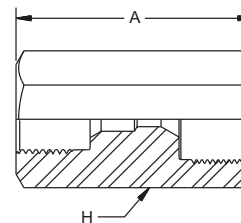

Part Number	Connection Type	A Overall Length	H Hex Size	Maximum Working Pressure
#				
		inch	inch	psi
5Y6Y-4-4C	1/4" M.P. Female to 1/4" H.P. Female	1.62	0.75	20,000
5Y6Y-4-6C	1/4" M.P. Female to 3/8" H.P. Female	1.87	1.00	20,000
5Y6Y-4-9C	1/4" M.P. Female to 9/16" H.P. Female	2.37	1.37	20,000
5Y6Y-6-4C	3/8" M.P. Female to 1/4" H.P. Female	1.75	0.75	20,000
5Y6Y-6-6C	3/8" M.P. Female to 3/8" H.P. Female	1.87	1.00	20,000
5Y6Y-6-9C	3/8" M.P. Female to 9/16" H.P. Female	2.37	1.37	20,000
5Y6Y-9-4C	9/16" M.P. Female to 1/4" H.P. Female	2.12	1.00	20,000
5Y6Y-9-6C	9/16" M.P. Female to 3/8" H.P. Female	2.12	1.00	20,000
5Y6Y-9-9C	9/16" M.P. Female to 9/16" H.P. Female	2.37	1.37	20,000
5Y6Y-12-4C	3/4" M.P. Female to 1/4" H.P. Female	2.50	1.37	20,000
5Y6Y-12-6C	3/4" M.P. Female to 3/8" H.P. Female	2.50	1.37	20,000
5Y6Y-12-9C	3/4" M.P. Female to 9/16" H.P. Female	2.50	1.37	20,000
5Y6Y-16-4C	1" M.P. Female to 1/4" H.P. Female	3.50	1.37	20,000
5Y6Y-16-6C	1" M.P. Female to 3/8" H.P. Female	3.50	1.37	20,000
5Y6Y-16-9C	1" M.P. Female to 9/16" H.P. Female	3.50	1.37	20,000

5Y02

Medium Pressure Female to NPT Female Coupling

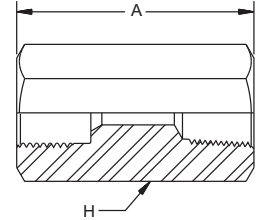

Part Number	Connection Type	A Overall Length	H Hex Size	Maximum Working Pressure
#				
		inch	inch	psi
5Y02-4-2C	1/4" M.P. Female to 1/8" NPT Female	1.62	0.75	15,000
5Y02-4-4C	1/4" M.P. Female to 1/4" NPT Female	1.62	0.75	15,000
5Y02-4-6C	1/4" M.P. Female to 3/8" NPT Female	2.00	1.00	15,000
5Y02-4-8C	1/4" M.P. Female to 1/2" NPT Female	2.00	1.12	15,000
5Y02-4-12C	1/4" M.P. Female to 3/4" NPT Female	2.37	1.37	10,000
5Y02-4-16C	1/4" M.P. Female to 1" NPT Female	2.62	2.00	10,000
5Y02-6-2C	3/8" M.P. Female to 1/8" NPT Female	1.75	0.75	15,000
5Y02-6-4C	3/8" M.P. Female to 1/4" NPT Female	1.75	0.75	15,000
5Y02-6-6C	3/8" M.P. Female to 3/8" NPT Female	2.12	1.00	15,000
5Y02-6-8C	3/8" M.P. Female to 1/2" NPT Female	2.12	1.12	15,000
5Y02-6-12C	3/8" M.P. Female to 3/4" NPT Female	2.37	1.37	10,000
5Y02-6-16C	3/8" M.P. Female to 1" NPT Female	2.75	2.00	10,000
5Y02-9-2C	9/16" M.P. Female to 1/8" NPT Female	2.12	1.00	15,000
5Y02-9-4C	9/16" M.P. Female to 1/4" NPT Female	2.12	1.00	15,000
5Y02-9-6C	9/16" M.P. Female to 3/8" NPT Female	2.12	1.00	15,000
5Y02-9-8C	9/16" M.P. Female to 1/2" NPT Female	2.25	1.12	15,000
5Y02-9-12C	9/16" M.P. Female to 3/4" NPT Female	2.50	1.37	10,000
5Y02-9-16C	9/16" M.P. Female to 1" NPT Female	2.87	2.00	10,000
5Y02-12-2C	3/4" M.P. Female to 1/8" NPT Female	2.50	1.37	15,000
5Y02-12-4C	3/4" M.P. Female to 1/4" NPT Female	2.50	1.37	15,000
5Y02-12-6C	3/4" M.P. Female to 3/8" NPT Female	2.50	1.37	15,000
5Y02-12-8C	3/4" M.P. Female to 1/2" NPT Female	2.50	1.37	15,000
5Y02-12-12C	3/4" M.P. Female to 3/4" NPT Female	2.75	1.50	10,000
5Y02-12-16C	3/4" M.P. Female to 1" NPT Female	3.00	1.87	15,000
5Y02-16-2C	1" M.P. Female to 1/8" NPT Female	3.00	1.75	15,000
5Y02-16-4C	1" M.P. Female to 1/4" NPT Female	3.00	1.75	15,000
5Y02-16-6C	1" M.P. Female to 3/8" NPT Female	3.00	1.75	15,000
5Y02-16-8C	1" M.P. Female to 1/2" NPT Female	3.00	1.75	15,000
5Y02-16-12C	1" M.P. Female to 3/4" NPT Female	3.50	1.50	10,000
5Y02-16-16C	1" M.P. Female to 1" NPT Female	3.75	1.87	10,000



Y5Y5

Medium Pressure Male to Medium Pressure Male

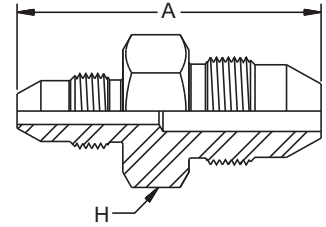

Part Number	Connection Type	A Overall Length	H Hex Size	Maximum Working Pressure
#				
		inch	inch	psi
Y5Y5-4-4C	1/4" M.P. Male to 1/4" M.P. Male	2.00	0.62	20,000
Y5Y5-4-6C	1/4" M.P. Male to 3/8" M.P. Male	2.12	0.75	20,000
Y5Y5-4-12C	1/4" M.P. Male to 3/4" M.P. Male	2.50	1.12	20,000
Y5Y5-4-16C	1/4" M.P. Male to 1" M.P. Male	3.62	1.00	20,000
Y5Y5-6-6C	3/8" M.P. Male to 3/8" M.P. Male	2.25	0.75	20,000
Y5Y5-6-9C	3/8" M.P. Male to 9/16" M.P. Male	2.50	0.87	20,000
Y5Y5-6-12C	3/8" M.P. Male to 3/4" M.P. Male	2.62	1.12	20,000
Y5Y5-6-16C	3/8" M.P. Male to 1" M.P. Male	3.75	1.00	20,000
Y5Y5-9-9C	9/16" M.P. Male to 9/16" M.P. Male	2.50	1.00	20,000
Y5Y5-9-12C	9/16" M.P. Male to 3/4" M.P. Male	2.87	1.12	20,000
Y5Y5-9-16C	9/16" M.P. Male to 1" M.P. Male	4.00	1.00	20,000
Y5Y5-12-12C	3/4" M.P. Male to 3/4" M.P. Male	3.00	1.12	20,000
Y5Y5-12-16C	3/4" M.P. Male to 1" M.P. Male	1.25	1.12	20,000

Y5Y6

Medium Pressure Male to High Pressure Male

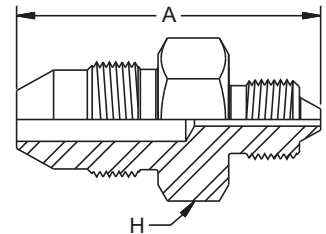

Part Number	Connection Type	A Overall Length	H Hex Size	Maximum Working Pressure
#				
		inch	inch	psi
Y5Y6-4-4C	1/4" M.P. Male to 1/4" H.P. Male	1.73	0.63	20,000
Y5Y6-4-6C	1/4" M.P. Male to 3/8" H.P. Male	2.10	0.75	20,000
Y5Y6-4-9C	1/4" M.P. Male to 9/16" H.P. Male	2.37	1.12	20,000
Y5Y6-6-4C	3/8" M.P. Male to 1/4" H.P. Male	2.12	0.62	20,000
Y5Y6-6-9C	3/8" M.P. Male to 9/16" H.P. Male	2.50	1.12	20,000
Y5Y6-9-4C	9/16" M.P. Male to 1/4" H.P. Male	2.25	0.87	20,000
Y5Y6-9-9C	9/16" M.P. Male to 9/16" H.P. Male	2.62	1.12	20,000
Y5Y6-12-4C	3/4" M.P. Male to 1/4" H.P. Male	2.62	1.12	20,000
Y5Y6-12-6C	3/4" M.P. Male to 3/8" H.P. Male	2.75	1.12	20,000
Y5Y6-12-9C	3/4" M.P. Male to 9/16" H.P. Male	3.00	1.12	20,000
Y5Y6-16-4C	1" M.P. Male to 1/4" H.P. Male	3.62	1.00	20,000
Y5Y6-16-6C	1" M.P. Male to 3/8" H.P. Male	4.00	1.00	20,000
Y5Y6-16-9C	1" M.P. Male to 9/16" H.P. Male	4.00	1.12	20,000

Y501

Medium Pressure Male to NPT Male

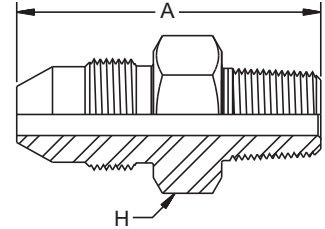

Part Number	Connection Type	A Overall Length	H Hex Size	Maximum Working Pressure
#				
		inch	inch	psi
Y501-4-4C	1/4" M.P. to 1/4" NPT Male	1.60	0.63	15,000
Y501-4-8C	1/4" M.P. to 1/2" NPT Male	2.12	0.87	15,000
Y501-6-4C	3/8" M.P. to 1/4" NPT Male	2.06	0.75	15,000
Y501-6-6C	3/8" M.P. to 3/8" NPT Male	2.06	0.75	15,000
Y501-6-8C	3/8" M.P. to 1/2" NPT Male	2.18	0.87	15,000
Y501-9-2C	9/16" M.P. to 1/8" NPT Male	2.12	0.87	15,000
Y501-9-4C	9/16" M.P. to 1/4" NPT Male	2.25	0.87	15,000
Y501-9-6C	9/16" M.P. to 3/8" NPT Male	2.25	0.87	15,000
Y501-9-8C	9/16" M.P. to 1/2" NPT Male	2.37	0.87	15,000
Y501-9-12C	9/16" M.P. to 3/4" NPT Male	2.62	1.12	10,000
Y501-9-16C	9/16" M.P. to 1" NPT Male	2.62	1.37	10,000
Y501-12-2C	3/4" M.P. to 1/8" NPT Male	2.37	1.12	15,000
Y501-12-4C	3/4" M.P. to 1/4" NPT Male	2.50	1.12	15,000
Y501-12-6C	3/4" M.P. to 3/8" NPT Male	2.50	1.12	15,000
Y501-12-8C	3/4" M.P. to 1/2" NPT Male	2.62	1.12	15,000
Y501-12-12C	3/4" M.P. to 3/4" NPT Male	2.75	1.12	10,000
Y501-12-16C	3/4" M.P. to 1" NPT Male	3.00	1.37	10,000
Y501-16-2C	1" M.P. to 1/8" NPT Male	3.62	1.00	15,000
Y501-16-4C	1" M.P. to 1/4" NPT Male	3.75	1.00	15,000
Y501-16-6C	1" M.P. to 3/8" NPT Male	3.75	1.00	15,000
Y501-16-8C	1" M.P. to 1/2" NPT Male	3.87	1.00	15,000
Y501-16-12C	1" M.P. to 3/4" NPT Male	3.87	1.12	10,000
Y501-16-16C	1" M.P. to 1" NPT Male	4.00	1.37	10,000



L5Y

Medium Pressure Elbow

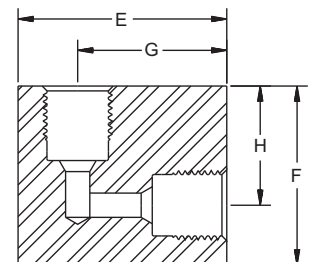

Part Number	Connection Type	Thickness	E	F	G	H	Maximum Working Pressure
#							
		inch	inch	inch	inch	inch	psi
L5Y-4C	1/4" M.P.	0.75	1.18	1.00	0.87	0.68	20,000
L5Y-6C	3/8" M.P.	0.75	1.37	1.37	1.00	1.00	20,000
L5Y-9C	9/16" M.P.	1.00	1.75	1.75	1.25	1.25	20,000
L5Y-12C	3/4" M.P.	1.37	2.25	2.25	1.50	1.50	20,000
L5Y-16C	1" M.P.	1.75	3.00	3.00	2.06	2.06	20,000

T5Y

Medium Pressure Tee

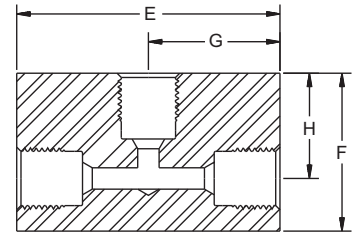

Part Number	Connection Type	Thickness	E	F	G	H	Maximum Working Pressure
#							
		inch	inch	inch	inch	inch	psi
T5Y-4C	1/4" M.P.	0.62	1.75	1.00	0.87	0.68	20,000
T5Y-6C	3/8" M.P.	0.75	2.00	1.37	1.00	1.00	20,000
T5Y-9C	9/16" M.P.	1.00	2.50	1.75	1.25	1.25	20,000
T5Y-12C	3/4" M.P.	1.37	3.00	2.25	1.50	1.50	20,000
T5Y-16C	1" M.P.	1.75	4.12	3.00	2.06	2.06	20,000

X5Y

Medium Pressure Cross

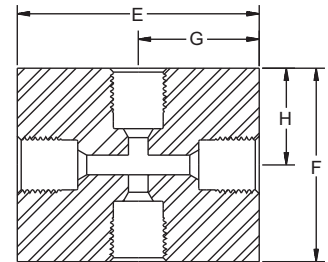

Part Number	Connection Type	Thickness	E	F	G	H	Maximum Working Pressure
#							
		inch	inch	inch	inch	inch	psi
X5Y-4C	1/4" M.P.	0.62	1.75	1.37	0.87	0.68	20,000
X5Y-6C	3/8" M.P.	0.75	2.00	2.00	1.00	1.00	20,000
X5Y-9C	9/16" M.P.	1.00	2.50	2.50	1.25	1.25	20,000
X5Y-12C	3/4" M.P.	1.37	3.00	3.00	1.50	1.50	20,000
X5Y-16C	1" M.P.	1.75	4.12	4.12	2.06	2.06	20,000

Y2N Medium Pressure Gland Nut

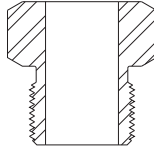

Part Number	Connection Type	Maximum Working Pressure
#		
		psi
Y2N-4C	1/4" M.P.	20,000
Y2N-6C	3/8" M.P.	20,000
Y2N-9C	9/16" M.P.	20,000
Y2N-12C	3/4" M.P.	20,000
Y2N-16C	1" M.P.	20,000

Y2C Medium Pressure Collar

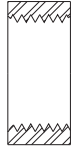

Part Number	Connection Type	Maximum Working Pressure
#		
		psi
Y2C-4C	1/4" M.P.	20,000
Y2C-6C	3/8" M.P.	20,000
Y2C-9C	9/16" M.P.	20,000
Y2C-12C	3/4" M.P.	20,000
Y2C-16C	1" M.P.	20,000



HBPLM Medium Pressure Plug



Part Number	Connection Type	Maximum Working Pressure
#		
		psi
HBPLM4-B	1/4" M.P.	20,000
HBPLM6-B	3/8" M.P.	20,000
HBPLM9-B	9/16" M.P.	20,000
HBPLM12-B	3/4" M.P.	20,000
HBPLM16-B	1" M.P.	20,000

Y204, Y206, Y209, Y212 and Y216 Medium Pressure Nipple

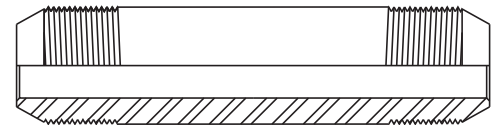

Length	1/4" O.D.	3/8" O.D.	9/16" O.D.	3/4" O.D.	1" O.D.
2.75"	Y204-0275C				
3"	Y204-0300C	Y206-0300C			
4"	Y204-0400C	Y206-0400C	Y209-0400C	Y212-0400C	
6"	Y204-0600C	Y206-0600C	Y209-0600C	Y212-0600C	Y216-0600C
8"	Y204-0800C	Y206-0800C	Y209-0800C	Y212-0800C	Y216-0800C
10"	Y204-1000C	Y206-1000C	Y209-1000C	Y212-1000C	Y216-1000C
12"	Y204-1200C	Y206-1200C	Y209-1200C	Y212-1200C	Y216-1200C

High Pressure

Sizes

1/4" O.D. x 0.08" I.D. • 9/16" - 18 male thread on gland nut
3/8" O.D. x 0.12" I.D. • 3/4" - 16 male thread on gland nut
9/16" O.D. x 0.18" I.D. • 1 1/8" - 12 male thread on gland nut

Identification is by tubing O.D.

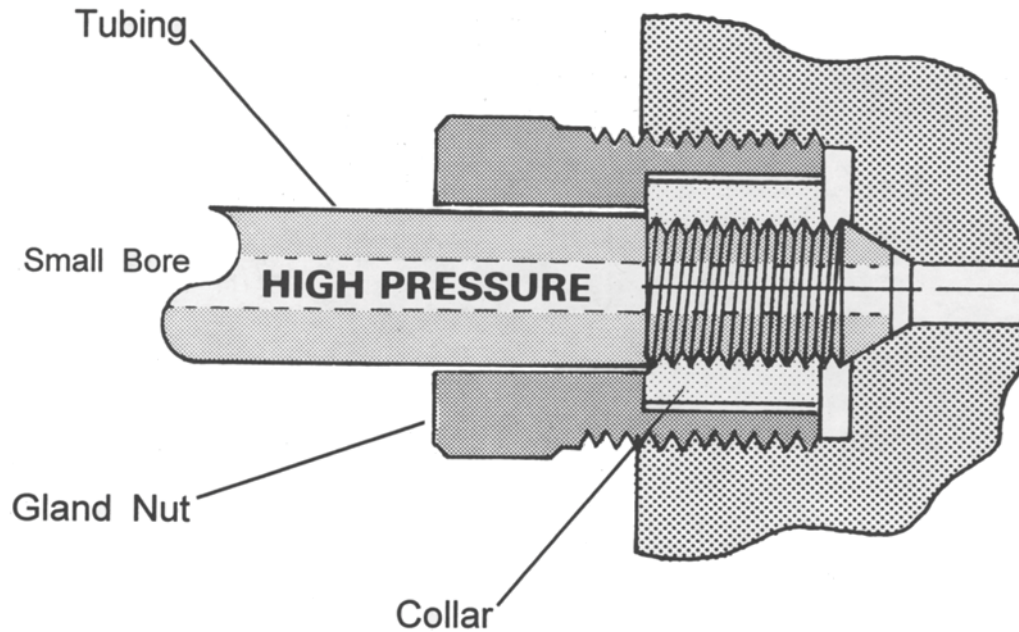

High Pressure is a 58/60 degree coned and threaded tubing design. *With small bore sizes, they have a maximum working pressure rating of 60,000 psi.*

Advantages:

- An industry standard for use at elevated pressures.
- Suitable for repetitive assembly and disassembly.

6YY6

Female High Pressure to Male High Pressure

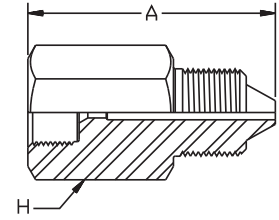

Part Number	Connection Type	A Overall Length	H Hex Size	Maximum Working Pressure
#				
		inch	inch	psi
6YY6-4-6C	1/4" H.P. Female to 3/8" H.P.	1.75	0.75	60,000
6YY6-4-9C	1/4" H.P. Female to 9/16" H.P.	2.12	1.12	60,000
6YY6-6-4C	3/8" H.P. Female to 1/4" H.P.	1.50	1.00	60,000
6YY6-6-9C	3/8" H.P. Female to 9/16" H.P.	2.12	1.12	60,000
6YY6-9-4C	9/16" H.P. Female to 1/4" H.P.	1.75	1.37	60,000
6YY6-9-6C	9/16" H.P. Female to 3/8" H.P.	1.87	1.37	60,000



6Y01

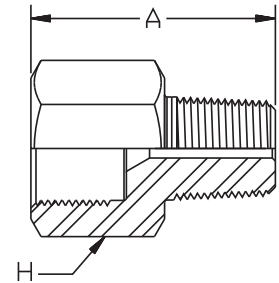

Female High Pressure to Male NPT



Part Number	Connection Type	A Overall Length	H Hex Size	Maximum Working Pressure
#				
		inch	inch	psi
6Y01-4-2C	1/4" H.P. to 1/8" NPT	1.25	0.75	15,000
6Y01-4-4C	1/4" H.P. to 1/4" NPT	1.37	0.75	15,000
6Y01-4-6C	1/4" H.P. to 3/8" NPT	1.37	0.75	15,000
6Y01-4-8C	1/4" H.P. to 1/2" NPT	1.75	1.00	15,000
6Y01-4-12C	1/4" H.P. to 3/4" NPT	1.75	1.37	10,000
6Y01-4-16C	1/4" H.P. to 1" NPT	1.62	1.37	10,000
6Y01-6-2C	3/8" H.P. to 1/8" NPT	1.50	1.00	15,000
6Y01-6-4C	3/8" H.P. to 1/4" NPT	1.62	1.00	15,000
6Y01-6-6C	3/8" H.P. to 3/8" NPT	1.62	1.00	15,000
6Y01-6-8C	3/8" H.P. to 1/2" NPT	1.75	1.00	15,000
6Y01-6-12C	3/8" H.P. to 3/4" NPT	1.87	1.37	10,000
6Y01-6-16C	3/8" H.P. to 1" NPT	1.87	1.37	10,000
6Y01-9-2C	9/16" H.P. to 1/8" NPT	1.50	1.37	15,000
6Y01-9-4C	9/16" H.P. to 1/4" NPT	1.62	1.27	15,000
6Y01-9-6C	9/16" H.P. to 3/8" NPT	1.75	1.37	15,000
6Y01-9-8C	9/16" H.P. to 1/2" NPT	1.87	1.37	15,000
6Y01-9-12C	9/16" H.P. to 3/4" NPT	1.87	1.37	10,000
6Y01-9-16C	9/16" H.P. to 1" NPT	2.00	1.37	10,000

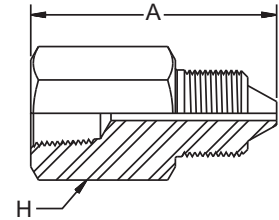

02Y6 Female NPT to Male High Pressure

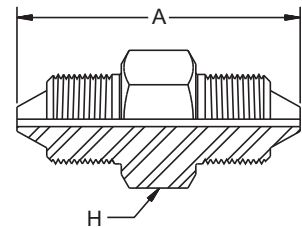

Part Number	Connection Type	A Overall Length	H Hex Size	Maximum Working Pressure
#				
		inch	inch	psi
02Y6-2-4C	1/8" NPT to 1/4" H.P.	1.62	0.75	15,000
02Y6-2-6C	1/8" NPT to 3/8" H.P.	1.62	0.75	15,000
02Y6-2-9C	1/8" NPT to 9/16" H.P.	2.12	1.12	15,000
02Y6-4-4C	1/4" NPT to 1/4" H.P.	1.75	0.75	15,000
02Y6-4-6C	1/4" NPT to 3/8" H.P.	1.75	0.75	15,000
02Y6-4-9C	1/4" NPT to 9/16" H.P.	2.12	1.12	15,000
02Y6-6-4C	3/8" NPT to 1/4" H.P.	1.75	1.00	15,000
02Y6-6-6C	3/8" NPT to 3/8" H.P.	1.75	1.00	15,000
02Y6-6-9C	3/8" NPT to 9/16" H.P.	2.12	1.12	15,000
02Y6-8-4C	1/2" NPT to 1/4" H.P.	2.12	1.12	15,000
02Y6-8-6C	1/2" NPT to 3/8" H.P.	2.12	1.12	15,000
02Y6-8-9C	1/2" NPT to 9/16" H.P.	2.12	1.12	15,000
02Y6-12-6C	3/4" NPT to 3/8" H.P.	1.50	1.62	10,000
02Y6-12-9C	3/4" NPT to 9/16" H.P.	2.25	1.37	10,000
02Y6-16-9C	1" NPT to 9/16" H.P.	2.00	2.75	10,000

Y6Y6 Male High Pressure to Male High Pressure



Part Number	Connection Type	A Overall Length	H Hex Size	Maximum Working Pressure
#				
		inch	inch	psi
Y6Y6-4-4C	1/4" H.P. to 1/4" H.P.	1.68	0.62	60,000
Y6Y6-4-6C	1/4" H.P. to 3/8" H.P.	2.06	0.75	60,000
Y6Y6-4-9C	1/4" H.P. to 9/16" H.P.	2.25	1.12	60,000
Y6Y6-6-6C	3/8" H.P. to 3/8" H.P.	2.25	0.75	60,000
Y6Y6-6-9C	3/8" H.P. to 9/16" H.P.	2.50	1.12	60,000
Y6Y6-9-9C	9/16" H.P. to 9/16" H.P.	2.62	1.12	60,000

Y601

Male High Pressure to Male NPT

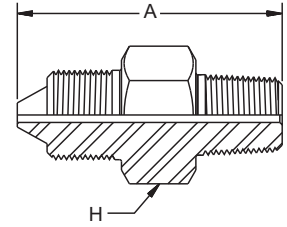

Part Number	Connection Type	A Overall Length	H Hex Size	Maximum Working Pressure
#				
		inch	inch	psi
Y601-4-2C	1/4" H.P. to 1/8" NPT	1.87	0.62	15,000
Y601-4-4C	1/4" H.P. to 1/4" NPT	2.06	0.75	15,000
Y601-4-6C	1/4" H.P. to 3/8" NPT	2.00	0.75	15,000
Y601-4-8C	1/4" H.P. to 1/2" NPT	2.12	0.87	15,000
Y601-4-12C	1/4" H.P. to 3/4" NPT	2.25	1.12	10,000
Y601-6-4C	3/8" H.P. to 1/4" NPT	2.12	0.87	15,000
Y601-6-6C	3/8" H.P. to 3/8" NPT	2.12	0.87	15,000
Y601-9-4C	9/16" H.P. to 1/4" NPT	2.37	1.12	15,000
Y601-9-6C	9/16" H.P. to 3/8" NPT	2.37	1.12	15,000
Y601-9-8C	9/16" H.P. to 1/2" NPT	2.50	1.12	15,000
Y601-9-12C	9/16" H.P. to 3/4" NPT	2.62	1.12	10,000
Y601-9-16C	9/16" H.P. to 1" NPT	2.75	1.37	10,000

C

6Y6Y

Straight Coupling

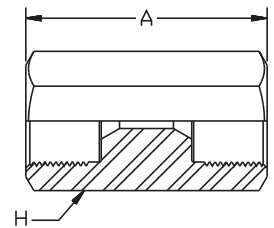

Part Number	Connection Type	A Overall Length	H Hex Size	Maximum Working Pressure
#				
		inch	inch	psi
6Y6Y-4-4C	1/4" H.P.	1.75	1.00	60,000
6Y6Y-6-6C	3/8" H.P.	2.00	1.00	60,000
6Y6Y-9-9C	9/16" H.P.	2.37	1.37	60,000

6Y6Y Reducer Coupling

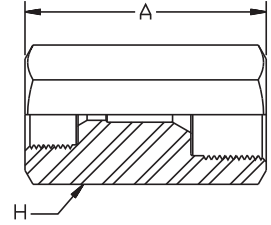

Part Number	Connection Type	A Overall Length	H Hex Size	Maximum Working Pressure
#				
		inch	inch	psi
6Y6Y-4-6C	1/4" H.P. to 3/8" H.P.	1.62	1.00	60,000
6Y6Y-4-9C	1/4" H.P. to 9/16" H.P.	1.75	1.37	60,000
6Y6Y-6-9C	3/8" H.P. to 9/16" H.P.	2.00	1.37	60,000

6Y02 Female High Pressure to Female NPT Coupling

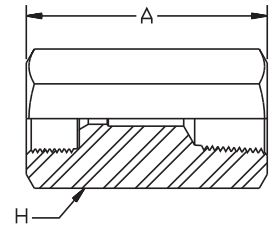

Part Number	Connection Type	A Overall Length	H Hex Size	Maximum Working Pressure
#				
		inch	inch	psi
6Y02-4-2C	1/4" H.P. to 1/8" NPT	1.50	1.00	15,000
6Y02-4-4C	1/4" H.P. to 1/4" NPT	1.50	1.00	15,000
6Y02-4-6C	1/4" H.P. to 3/8" NPT	1.87	1.00	15,000
6Y02-4-8C	1/4" H.P. to 1/2" NPT	1.87	1.12	15,000
6Y02-4-12C	1/4" H.P. to 3/4" NPT	2.00	1.62	10,000
6Y02-4-16C	1/4" H.P. to 1" NPT	2.50	1.75	10,000
6Y02-6-2C	3/8" H.P. to 1/8" NPT	1.87	1.00	15,000
6Y02-6-4C	3/8" H.P. to 1/4" NPT	1.87	1.00	15,000
6Y02-6-6C	3/8" H.P. to 3/8" NPT	1.87	1.00	15,000
6Y02-6-8C	3/8" H.P. to 1/2" NPT	1.87	1.12	15,000
6Y02-6-12C	3/8" H.P. to 3/4" NPT	2.12	1.37	10,000
6Y02-6-16C	3/8" H.P. to 1" NPT	2.50	1.75	10,000
6Y02-9-2C	9/16" H.P. to 1/8" NPT	2.37	1.37	15,000
6Y02-9-4C	9/16" H.P. to 1/4" NPT	2.37	1.37	15,000
6Y02-9-6C	9/16" H.P. to 3/8" NPT	2.37	1.37	15,000
6Y02-9-8C	9/16" H.P. to 1/2" NPT	2.37	1.37	15,000
6Y02-9-12C	9/16" H.P. to 3/4" NPT	2.37	1.37	10,000
6Y02-9-16C	9/16" H.P. to 1" NPT	2.62	2.00	10,000

L6Y

High Pressure Elbow

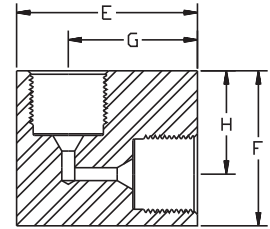

Part Number	Connection Type	Thickness	E	F	G	H	Maximum Working Pressure
#							
		inch	inch	inch	inch	inch	psi
L6Y-4C	1/4" H.P.	1.00	1.37	1.50	0.87	1.00	60,000
L6Y-6C	3/8" H.P.	1.00	1.75	1.50	1.25	1.00	60,000
L6Y-9C	9/16" H.P.	1.50	2.62	1.87	1.12	1.12	60,000



T6Y

High Pressure Tee

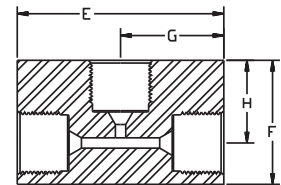

Part Number	Connection Type	Thickness	E	F	G	H	Maximum Working Pressure
#							
		inch	inch	inch	inch	inch	psi
T6Y-4C	1/4" H.P.	1.00	2.00	1.37	1.00	0.87	60,000
T6Y-6C	3/8" H.P.	1.00	2.00	1.56	1.00	1.06	60,000
T6Y-9C	9/16" H.P.	1.50	2.62	2.12	1.62	1.37	60,000

X6Y

High Pressure Cross

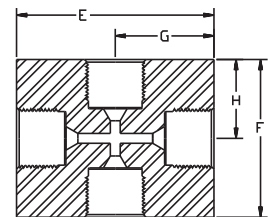

Part Number	Connection Type	Thickness	E	F	G	H	Maximum Working Pressure
#							
		inch	inch	inch	inch	inch	psi
X6Y-4C	1/4" H.P.	1.00	2.00	1.50	1.00	0.75	60,000
X6Y-6C	3/8" H.P.	1.00	2.12	2.00	1.06	1.00	60,000
X6Y-9C	9/16" H.P.	1.50	2.75	2.62	1.37	1.31	60,000

Y4N High Pressure Gland Nut

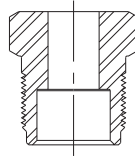

Part Number	Connection Type	Maximum Working Pressure
#		
		psi
Y4N-4C	1/4" H.P.	60,000
Y4N-6C	3/8" H.P.	60,000
Y4N-9C	9/16" H.P.	60,000

Y4C High Pressure Collar

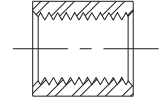

Part Number	Connection Type	Maximum Working Pressure
#		
		psi
Y4C-4C	1/4" H.P.	60,000
Y4C-6C	3/8" H.P.	60,000
Y4C-9C	9/16" H.P.	60,000

HBPBM High Pressure Plug

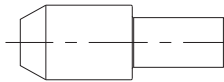

Part Number	Connection Type	Maximum Working Pressure
#		
		psi
HBPBM4-B	1/4" H.P.	60,000
HBPBM6-B	3/8" H.P.	60,000
HBPBM9-B	9/16" H.P.	60,000

Nipples High Pressure



Length	1/4" O.D.	3/8" O.D.	9/16" O.D.
2.75"	Y404-0275C	—	—
3"	Y404-0300C	Y406-0300C	—
4"	Y404-0400C	—	Y409-0400C
6"	Y404-0600C	Y406-0600C	Y409-0600C
8"	Y404-0800C	Y406-0800C	Y409-0800C
10"	Y404-1000C	Y406-1000C	Y409-1000C
12"	Y404-1200C	Y406-1200C	Y409-1200C

Locking Nut/Collar Anti-Vibration

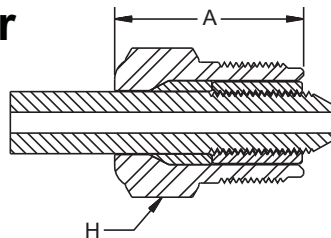

Locking Nut and Collar Part Number	Tube O.D.	A Length	H Hex Size
#			
	inch	inch	inch
Y4NC-4C-AV	1/4" H.P.	0.68	0.63
Y4NC-6C-AV	3/8" H.P.	1.06	0.68
Y4NC-9C-AV	9/16" H.P.	1.56	1.68

National Pipe Tapered (NPT)

polyflex™ offers a broad range of high quality stainless steel high pressure NPT adapters. Sizes 1/8" to 1/2" are rated up to 15,000 psi, 3/4" and above are rated to 10,000 psi.



K0202 NPT Coupler

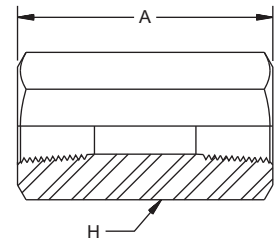

Part Number	Connection Type	A Overall Length	H Hex Size	Maximum Working Pressure
#				
		inch	inch	psi
10K0202-12-12C	3/4" NPT Female	2.13	1.50	10,000
10K0202-16-16C	1" NPT Female	2.50	2.00	10,000
15K0202-2-2C	1/8" NPT Female	1.50	0.75	15,000
15K0202-4-4C	1/4" NPT Female	1.75	0.87	15,000
15K0202-6-6C	3/8" NPT Female	1.75	1.00	15,000
15K0202-8-8C	1/2" NPT Female	2.13	1.25	15,000

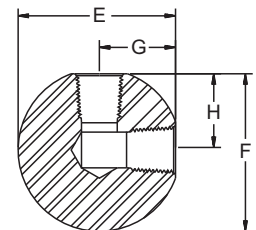

KL02 NPT Elbow



Part Number	Connection Type	Thickness	E	F	G	H	Maximum Working Pressure
#							
		inch	inch	inch	inch	inch	psi
10KL02-12C	3/4" NPT Female	2.05	1.85	1.85	1.35	1.35	10,000
10KL02-16C	1" NPT Female	2.50	3.83	3.83	1.82	1.82	10,000
15KL02-4C	1/4" NPT Female	1.15	1.70	1.70	0.80	0.80	15,000
15KL02-6C	3/8" NPT Female	1.38	1.90	1.90	0.90	0.90	15,000
15KL02-8C	1/2" NPT Female	1.63	2.15	2.15	1.03	1.03	15,000

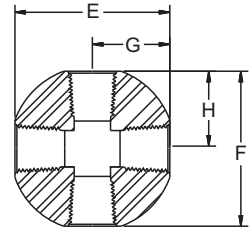

KX02
NPT Cross

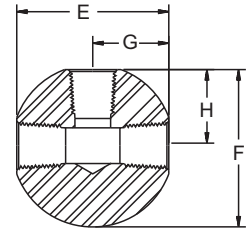

Part Number	Connection Type	Thickness	E	F	G	H	Maximum Working Pressure
#							
		inch	inch	inch	inch	inch	psi
10KX02-12C	3/4" NPT Female	2.05	2.70	2.70	1.35	1.35	10,000
10KX02-16C	1" NPT Female	2.50	3.63	3.63	1.82	1.82	10,000
15KX02-4C	1/4" NPT Female	1.15	1.60	1.60	0.80	0.80	15,000
15KX02-6C	3/8" NPT Female	1.38	1.80	1.80	0.90	0.90	15,000
15KX02-8C	1/2" NPT Female	1.63	2.05	2.05	1.03	1.03	15,000

KT02
NPT Tee





Part Number	Connection Type	Thickness	E	F	G	H	Maximum Working Pressure
#							
		inch	inch	inch	inch	inch	psi
10KT02-12C	3/4" NPT Female	2.05	2.70	1.85	1.35	2.05	10,000
10KT02-16C	1" NPT Female	2.50	3.63	3.83	1.82	2.50	10,000
15KT02-4C	1/4" NPT Female	1.15	1.60	1.70	0.80	1.15	15,000
15KT02-6C	3/8" NPT Female	1.38	1.80	1.90	0.90	1.38	15,000
15KT02-8C	1/2" NPT Female	1.63	2.05	2.15	1.03	1.63	15,000

K0101

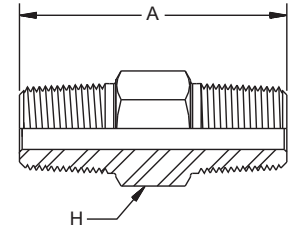
NPT Nipple







Part Number	Connection Type	A Overall Length	H Hex Size	Maximum Working Pressure
#				
		inch	inch	psi
10K0101-12-12C	3/4" NPT Male	2.44	1.13	10,000
10K0101-16-16C	1" NPT Male	2.75	1.38	10,000
15K0101-1-1C	1/16" NPT Male	1.00	0.38	15,000
15K0101-2-2C	1/8" NPT Male	1.20	0.50	15,000
15K0101-4-4C	1/4" NPT Male	1.44	0.63	15,000
15K0101-6-6C	3/8" NPT Male	1.70	0.75	15,000
15K0101-8-8C	1/2" NPT Male	2.25	1.00	15,000

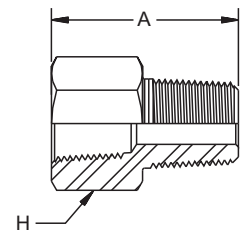

K0201

NPT Reducer Bushing



Part Number	Connection Type	A Overall Length	H Hex Size	Maximum Working Pressure
#				
		inch	inch	psi
15K0201-1-8C	1/16" NPT Female to 1/2" NPT Male	1.25	0.87	15,000
15K0201-2-8C	1/8" NPT Female to 1/2" NPT Male	1.25	0.87	15,000
15K0201-4-8C	1/4" NPT Female to 1/2" NPT Male	1.25	0.87	15,000
15K0201-6-8C	3/8" NPT Female to 1/2" NPT Male	1.63	1.00	15,000

Valves

Medium Pressure — up to 20,000 psi
High Pressure — up to 60,000 psi

Developed to assure safe and easy plumbing through 60,000 psi. These needle valves are engineered to the highest standards of repeatable quality. The medium pressure valves are designed with a compact cone-and-threaded connection which permits the larger bore sizes and increased flow rates common in this pressure class. The high pressure valves also use a coned-and-threaded connection which accommodates the high pressures common in these applications.

Non-rotating tip stems are standard for on-off service and insure long life on valve seats.

Materials include high tensile type 316 stainless steel bodies and hardened 17-4PH stainless steel lower section stems.

Packing is TFE standard with optional Viton®, BUNA-N and Grafoil available as non-standard.

Two Way Straight valves are standard with five additional patterns to satisfy widely varied requirements are available

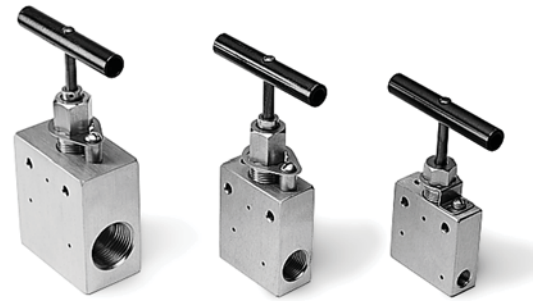

on request.

Features:

- Non-Rotating Stem Tips
- Packing Below Stem Threads
- Type 316 ss high tensile bodies
- Positive gland lock device
- No stem adjustment needed
- Black T-handles standard or choice of 4 colors (special order)
- Tube sizes
Medium Pressure — 1/4" through 1"
High Pressure — 1/4" through 9/16"

SV5Y Two Way Straight Valves Medium Pressure – 20,000 psi

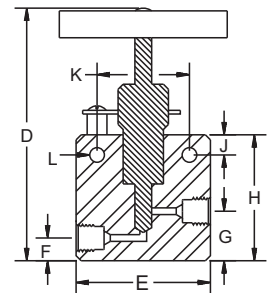

Part Number	Connection Type	Orifice	Thickness	D	E	F	G	H	J	K	L	Maximum Working Pressure
#												
				inch	inch	inch	inch	inch	inch	inch	inch	psi
SV5Y-12C-20	3/4" Medium Pressure	0.51	1.37	7.00	3.00	0.75	1.50	3.75	0.62	1.75	0.43	20,000
SV5Y-16C-20	1" Medium Pressure	0.68	1.75	8.42	4.12	0.87	1.81	4.62	1.12	2.50	0.56	20,000
SV5Y-4C-20	1/4" Medium Pressure	0.10	0.75	4.37	2.00	0.37	0.81	2.00	0.37	1.25	0.21	20,000
SV5Y-6C-20	3/8" Medium Pressure	0.20	0.75	4.37	2.00	0.37	0.81	2.00	0.37	1.25	0.21	20,000
SV5Y-9C-20	9/16" Medium Pressure	0.31	1.00	6.12	2.50	0.50	1.12	2.87	0.50	1.37	0.34	20,000

AV5Y

Two Way Angle Valves

Medium Pressure – 20,000 psi

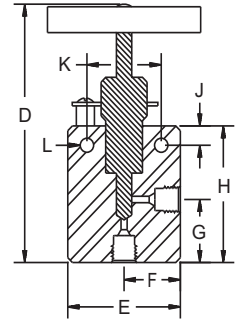

Part Number	Connection Type	Orifice	Thickness	D	E	F	G	H	J	K	L	Maximum Working Pressure
#												
				inch	inch	inch	inch	inch	inch	inch	inch	psi
AV5Y-4C-20	1/4" Medium Pressure	0.10	0.75	4.81	2.00	1.00	1.25	2.43	0.37	1.25	0.21	20,000
AV5Y-6C-20	3/8" Medium Pressure	0.20	0.75	4.81	2.00	1.00	1.25	2.43	0.37	1.25	0.21	20,000
AV5Y-9C-20	9/16" Medium Pressure	0.31	1.00	6.62	2.50	1.25	1.62	3.37	0.50	1.37	0.34	20,000
AV5Y-12C-20	3/4" Medium Pressure	0.51	1.37	7.50	3.00	1.50	2.00	4.25	0.62	1.75	0.43	20,000
AV5Y-16C-20	1" Medium Pressure	0.68	1.75	9.37	4.12	2.06	2.56	5.43	1.12	2.50	0.56	20,000



TV25Y

Three Way Valves

Medium Pressure – 20,000 psi

Two Pressure Connections

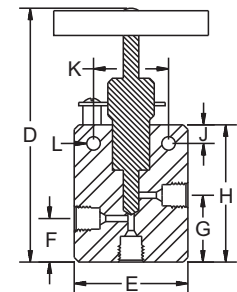

Part Number	Connection Type	Orifice	Thickness	D	E	F	G	H	J	K	L	Maximum Working Pressure
#												
				inch	inch	inch	inch	inch	inch	inch	inch	psi
TV25Y-4C-20	1/4" Medium Pressure	0.10	0.75	5.00	2.00	1.00	1.43	2.62	0.37	1.25	0.21	20,000
TV25Y-6C-20	3/8" Medium Pressure	0.20	0.75	5.00	2.00	1.00	1.43	2.62	0.37	1.25	0.21	20,000
TV25Y-9C-20	9/16" Medium Pressure	0.31	1.00	6.87	2.50	1.25	1.87	3.62	0.50	1.37	0.34	20,000
TV25Y-12C-20	3/4" Medium Pressure	0.51	1.37	7.87	3.00	2.62	2.37	4.62	0.62	1.75	0.43	20,000
TV25Y-16C-20	1" Medium Pressure	0.68	1.75	9.75	4.12	2.12	3.06	5.87	1.12	2.50	0.56	20,000

TV15Y
Three Way Valves
Medium Pressure – 20,000 psi
One Pressure Connection

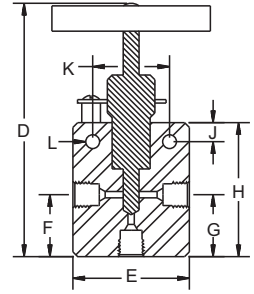

Part Number	Connection Type	Orifice	Thickness	D	E	F	G	H	J	K	L	Maximum Working Pressure
#												
				inch	inch	inch	inch	inch	inch	inch	inch	psi
TV15Y-4C-20	1/4" Medium Pressure	0.10	0.75	4.81	2.00	1.25	1.25	2.43	0.37	1.25	0.21	20,000
TV15Y-6C-20	3/8" Medium Pressure	0.20	0.75	4.81	2.00	1.25	1.25	2.43	0.37	1.25	0.21	20,000
TV15Y-9C-20	9/16" Medium Pressure	0.31	1.00	6.62	2.50	1.62	1.62	3.37	0.50	1.37	0.34	20,000
TV15Y-12C-20	3/4" Medium Pressure	0.51	1.37	7.50	3.00	2.00	2.00	4.25	0.62	1.75	0.43	20,000
TV15Y-16C-20	1" Medium Pressure	0.68	1.75	9.37	4.12	2.62	2.62	5.43	1.12	2.50	0.56	20,000

CV5Y
Ball Check Valves
Medium Pressure

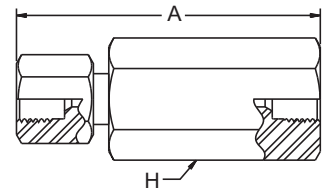

Part Number	Connection Type	A Overall Length	H Hex Size	Maximum Working Pressure
#				
		inch	inch	psi
CV5Y-4C-20	1/4" Medium pressure	3.75	1.00	20,000
CV5Y-6C-20	3/8" Medium Pressure	3.75	1.00	20,000
CV5Y-9C-20	9/16" Medium Pressure	0.35	1.37	20,000

SV6Y
Two Way Straight Valves
High Pressure – 30,000 psi

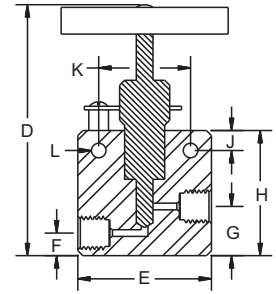

Part Number	Connection Type	Orifice	Thickness	D	E	F	G	H	J	K	L	Maximum Working Pressure
#												
				inch	inch	inch	inch	inch	inch	inch	inch	psi
SV6Y-4C-30	1/4" High pressure	0.09	1.00	5.18	2.00	0.62	1.00	2.43	0.50	1.37	0.21	30,000
SV6Y-6C-30	3/8" High Pressure	0.12	1.00	5.18	2.00	0.62	1.00	2.43	0.50	1.37	0.21	30,000
SV6Y-9C-30	9/16" High Pressure	0.12	1.50	5.62	2.62	1.00	1.43	2.87	0.50	1.37	0.21	30,000



AV6Y
Two Way Angle Valves
High Pressure – 30,000 psi

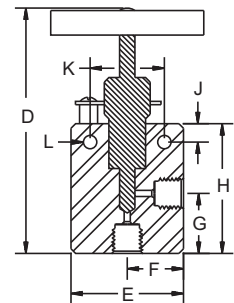

Part Number	Connection Type	Orifice	Thickness	D	E	F	G	H	J	K	L	Maximum Working Pressure
#												
				inch	inch	inch	inch	inch	inch	inch	inch	psi
AV6Y-4C-30	1/4" High pressure	0.09	1.00	5.18	2.00	1.00	1.00	2.43	0.50	1.37	0.21	30,000
AV6Y-6C-30	3/8" High Pressure	0.12	1.00	5.56	2.00	1.00	1.37	2.81	0.50	1.37	0.21	30,000
AV6Y-9C-30	9/16" High Pressure	0.12	1.50	5.62	2.62	1.31	1.43	2.87	0.50	1.37	0.21	30,000

TV26Y
Three Way Valves
High Pressure – 30,000 psi
Two Pressure Connections

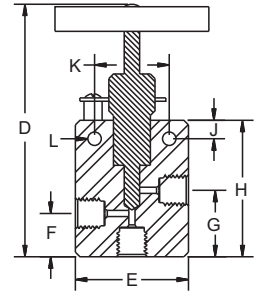

Part Number	Connection Type	Orifice	Thickness	D	E	F	G	H	J	K	L	Maximum Working Pressure
#												
				inch	inch	inch	inch	inch	inch	inch	inch	psi
TV26Y-4C-30	1/4" High pressure	0.09	1.00	5.18	2.00	0.62	1.00	2.43	0.50	1.37	0.21	30,000
TV26Y-6C-30	3/8" High Pressure	0.12	1.00	5.56	2.00	1.00	1.37	2.81	0.50	1.37	0.21	30,000
TV26Y-9C-30	9/16" High Pressure	0.12	1.50	6.06	2.62	1.43	1.87	3.31	0.50	1.37	0.21	30,000

TV16Y
Three Way Valves
High Pressure – 30,000 psi
One Pressure Connection

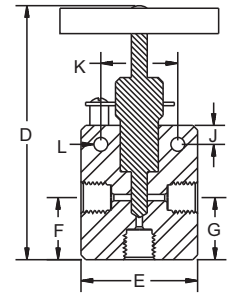

Part Number	Connection Type	Orifice	Thickness	D	E	F	G	H	J	K	L	Maximum Working Pressure
#												
				inch	inch	inch	inch	inch	inch	inch	inch	psi
TV16Y-4C-30	1/4" High pressure	0.09	1.00	5.18	2.00	1.00	1.00	2.43	0.50	1.37	0.21	30,000
TV16Y-6C-30	3/8" High Pressure	0.12	1.00	5.56	2.00	2.00	1.43	2.81	0.50	1.37	0.21	30,000
TV16Y-9C-30	9/16" High Pressure	0.12	1.50	5.62	2.62	2.18	1.43	2.87	0.50	1.37	0.21	30,000

SV6Y
Two Way Straight Valves
High Pressure – 60,000 psi

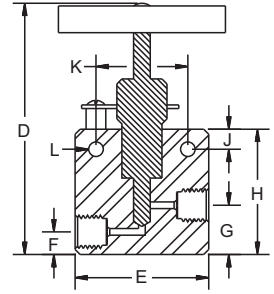

Part Number	Connection Type	Orifice	Thickness	D	E	F	G	H	J	K	L	Maximum Working Pressure
#												
				inch	inch	inch	inch	inch	inch	inch	inch	psi
SV6Y-4C-60	1/4" High pressure	0.06	1.00	5.18	2.00	0.62	1.00	2.43	0.50	1.37	0.21	60,000
SV6Y-6C-60	3/8" High Pressure	0.06	1.00	5.18	2.00	0.62	1.00	2.43	0.50	1.37	0.21	60,000
SV6Y-9C-60	9/16" High Pressure	0.06	1.50	5.62	2.62	1.00	1.43	2.87	0.50	1.37	0.21	60,000



AV6Y
Two Way Angle Valves
High Pressure – 60,000 psi

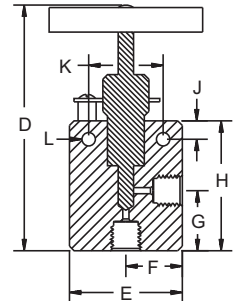

Part Number	Connection Type	Orifice	Thickness	D	E	F	G	H	J	K	L	Maximum Working Pressure
#												
				inch	inch	inch	inch	inch	inch	inch	inch	psi
AV6Y-4C-60	1/4" High pressure	0.06	1.00	5.18	2.00	1.00	1.00	2.43	0.50	1.37	0.21	60,000
AV6Y-6C-60	3/8" High Pressure	0.06	1.00	5.56	2.00	1.00	1.37	2.81	0.50	1.37	0.21	60,000
AV6Y-9C-60	9/16" High Pressure	0.06	1.50	5.62	2.62	1.31	1.43	2.87	0.50	1.37	0.21	60,000

TV26Y
Three Way Valves
High Pressure – 60,000 psi
Two Pressure Connections

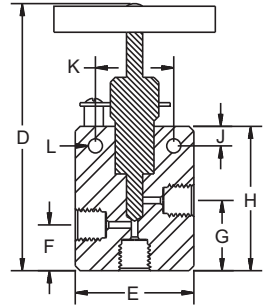

Part Number	Connection Type	Orifice	Thickness	D	E	F	G	H	J	K	L	Maximum Working Pressure
#												
				inch	inch	inch	inch	inch	inch	inch	inch	psi
TV26Y-4C-60	1/4" High pressure	0.06	1.00	5.18	2.00	0.62	1.00	2.43	0.50	1.37	0.21	60,000
TV26Y-6C-60	3/8" High Pressure	0.06	1.00	5.56	2.00	1.00	1.37	2.81	0.50	1.37	0.21	60,000
TV26Y-9C-60	9/16" High Pressure	0.06	1.50	6.06	2.62	1.43	1.87	3.31	0.50	1.37	0.21	60,000

TV16Y
Three Way Valves
High Pressure – 60,000 psi
One Pressure Connection

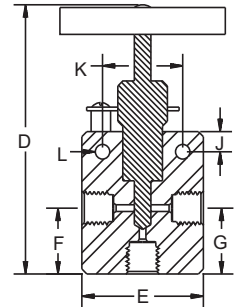

Part Number	Connection Type	Orifice	Thickness	D	E	F	G	H	J	K	L	Maximum Working Pressure
#												
				inch	inch	inch	inch	inch	inch	inch	inch	psi
TV16Y-4C-60	1/4" High pressure	0.06	1.00	5.18	2.00	1.00	1.00	2.43	0.50	1.37	0.21	60,000
TV16Y-6C-60	3/8" High Pressure	0.06	1.00	5.56	2.00	2.00	1.43	2.81	0.50	1.37	0.21	60,000
TV16Y-9C-60	9/16" High Pressure	0.06	1.50	5.62	2.62	2.18	1.43	2.87	0.50	1.37	0.21	60,000

CV6Y
Ball Check Valves
High Pressure

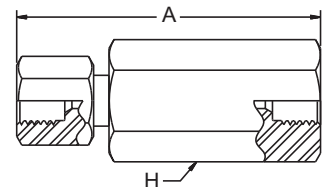

Part Number	Connection Type	A Overall Length	H Hex Size	Maximum Working Pressure
#				
		inch	inch	psi
CV6Y-4C-60	1/4" High pressure	4.18	1.50	60,000
CV6Y-6C-60	3/8" High Pressure	4.25	1.50	60,000
CV6Y-9C-60	9/16" High Pressure	4.62	1.56	60,000

Table of Contents

Rogan Series —

30,000 psi Maximum Working Pressure

HP006 Coupler	D3
HP006 Nipple (without Check Valve)	D4
HP006 Nipple (with Check Valve)	D5
HP010 Coupler	D6
HP010 Nipple (without Check Valve)	D7
HP010 Nipple (with Check Valve)	D8

C Series Hydraulic Couplers —

29,800 psi Maximum Working Pressure

115 Coupler	D10
115 Nipple	D11
116 Coupler	D12
116 Nipple	D13
125 Coupler	D13
125 Nipple	D14
Adapters	D15

WB Series Waterblast Couplers —

10,000 psi Maximum Working Pressure

WB Coupler	D17
WB Nipple	D17



Rogan Series

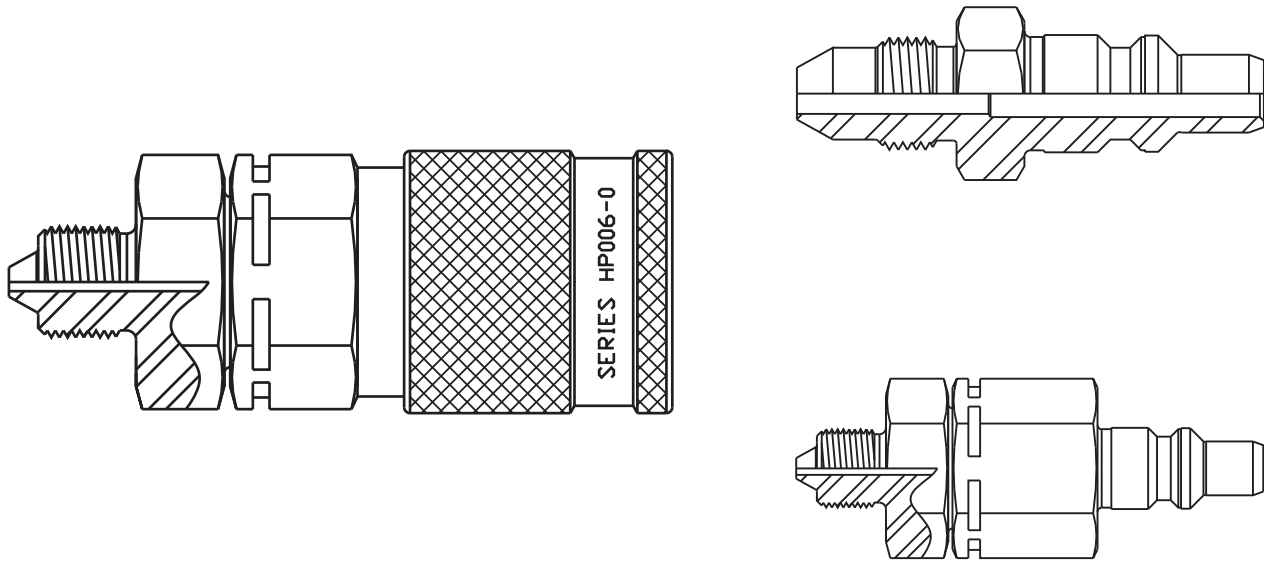



A versatile connecting device that permits easy and rapid joining of hose assemblies to your system. Each coupling is assembled and pressure tested to at least 5,000 psi above its maximum rated working pressure. Couplings with check-valve can withstand the full working pressure in the disconnected condition.

Type	Max. Working Pressure (psi)	Test Pressure (psi)	Nominal Thru Hole Diameter (in)
HP006	30,000	35,000	0.24
HP010	20,000	25,000	0.40

NOTE: The choice of the threaded end form may limit the working pressure and the size of the thru hole in the coupling. Call **polyflex™** for additional information.

HP006

Coupler

Part Number	Connection Type	A Overall Length	H Hex Size	Maximum Working Pressure
#				
		inch	inch	psi
HP006-0-A9	Type "M" (9/16" - 18 threads)	3.30	1.19	30,000
HP006-0-A12	Type "M" (3/4" - 16 threads)	3.34	1.19	30,000
HP006-0-HM4	1/4" High Pressure Male	3.46	1.19	30,000
HP006-0-HM9	9/16" High Pressure Male	3.70	1.19	30,000
HP006-0-LM6	3/8" Medium Pressure Male	3.54	1.19	20,000
HP006-0-NFB	1/4" NPT Female	3.30	1.19	15,000
HP006-0-NFC	3/8" NPT Female	3.30	1.19	15,000
HP006-0-NMB	1/4" NPT Male	3.40	1.19	15,000
HP006-0-NMC	3/8" NPT Male	3.30	1.19	15,000
HP006-0-NMD	1/2" NPT Male	3.45	1.19	15,000
HP006-0-X13	Low Angle Face Seal (9/16" - 18 threads)	3.37	1.19	30,000

D

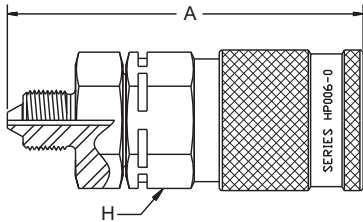

HP006-0-HM4

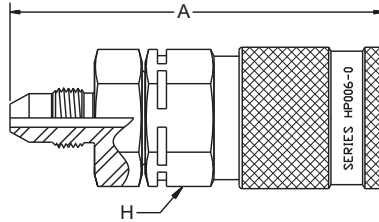

HP006-0-LM6

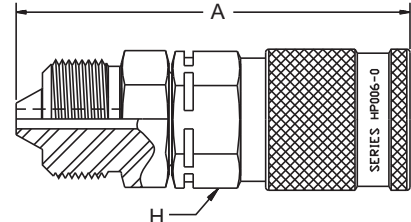

HP006-0-HM9

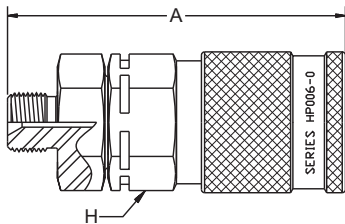

**HP006-0-A9,
 HP006-0-A12**

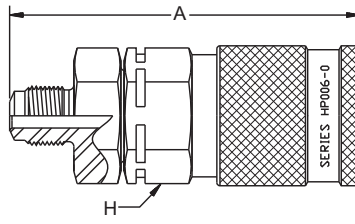

HP006-0-X13

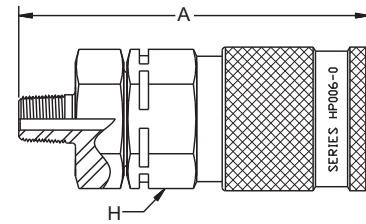

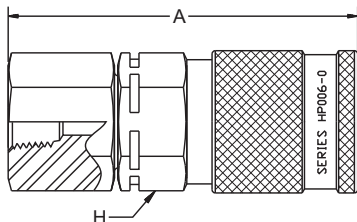

**HP006-0-NMB,
 HP006-0-NMC,
 HP006-0-NMD**



**HP006-0-NFB,
 HP006-0-NFC**

HP006
Nipple
Without Check Valve

Part Number	Connection Type	A Overall Length	H Hex Size	Maximum Working Pressure
#				
		inch	inch	psi
HP006-1-A9	Type "M" (9/16" - 18 threads)	1.98	0.75	30,000
HP006-1-A12	Type "M" (3/4" - 16 threads)	2.16	0.87	30,000
HP006-1-HM4	1/4" High Pressure Male	2.25	0.75	30,000
HP006-1-LM6	3/8" Medium Pressure Male	2.33	0.75	20,000
HP006-1-LM9	9/16" Medium Pressure Male	2.57	1.00	20,000
HP006-1-NMB	1/4" NPT Male	2.09	0.75	15,000
HP006-1-NMC	3/8" NPT Male	2.13	0.75	15,000
HP006-1-NMD	1/2" NPT Male	2.31	1.00	15,000
HP006-1-X13	Low Angle Face Seal (9/16" - 18 threads)	2.17	0.75	30,000

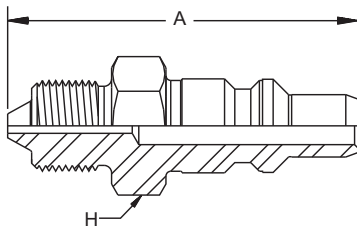

HP006-1-HM4

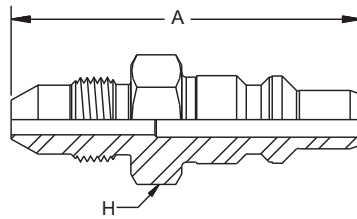

**HP006-1-LM6,
 HP006-1-LM9**

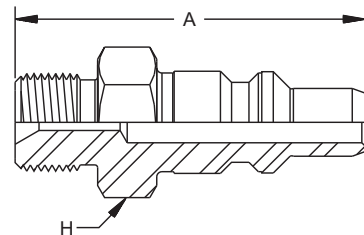

**HP006-1-A9,
 HP006-1-A12**

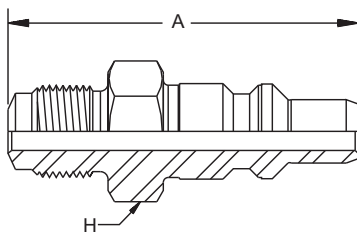

HP006-1-X13

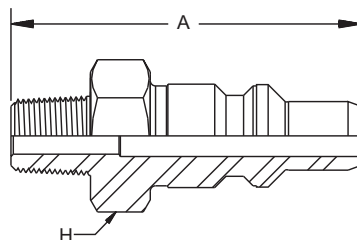



**HP006-1-NMB,
 HP006-1-NMC,
 HP006-1-NMD**

HP006

Nipple

With Check Valve

Part Number	Connection Type	A Overall Length	H Hex Size	Maximum Working Pressure
#				
		inch	inch	psi
HP006-2-A9	Type "M" (9/16" - 18 threads)	3.28	1.19	30,000
HP006-2-A12	Type "M" (3/4" - 16 threads)	3.30	1.19	30,000
HP006-2-HM4	1/4" High Pressure Male	3.45	1.19	30,000
HP006-2-LM6	3/8" Medium Pressure Male	3.52	1.19	20,000
HP006-2-NFB	1/4" NPT Female	3.26	1.19	15,000
HP006-2-NFC	3/8" NPT Female	3.25	1.19	15,000
HP006-2-NMB	1/4" NPT Male	3.34	1.19	15,000
HP006-2-NMC	3/8" NPT Male	3.34	1.19	15,000
HP006-2-NMD	1/2" NPT Male	3.43	1.19	15,000
HP006-2-X13	Low Angle Face Seal (9/16" - 18 threads)	3.35	1.19	30,000

D

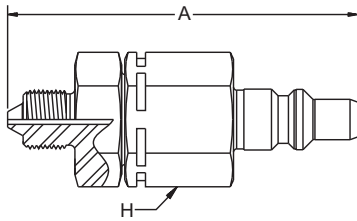

HP006-2-HM4

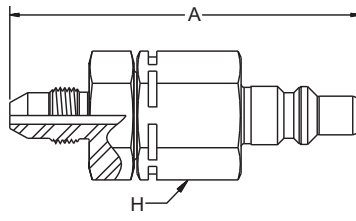

HP006-2-LM6

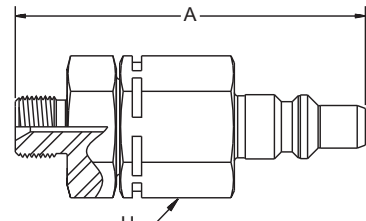

**HP006-2-A9,
 HP006-2-A12**

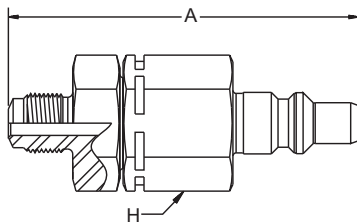

HP006-2-X13

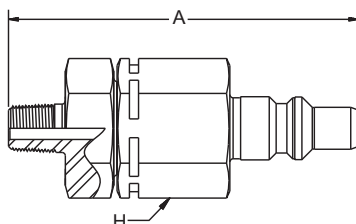

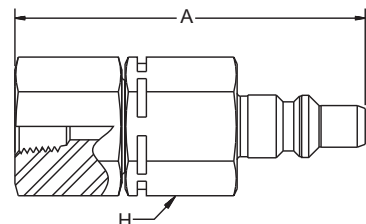

**HP006-2-NMB,
 HP006-2-NMC,
 HP006-2-NMB**



**HP006-2-NFB,
 HP006-2-NFC**

HP010

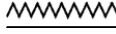
Coupler

Part Number	Connection Type	A Overall Length	H Hex Size	Maximum Working Pressure				
#								
		inch	inch	psi				
HP010-0-A12	Type "M" (3/4" - 16 threads)	4.00	1.62	20,000				
HP010-0-A16	Type "M" (1" - 12 threads)	4.10	1.62	20,000				
HP010-0-LM12	3/4" Medium Pressure Male	4.64	1.62	20,000				
HP010-0-NFD	1/2" NPT Female	4.27	1.62	15,000				
HP010-0-NMD	1/2" NPT Male	4.13	1.62 </tr <tr> <td>HP010-0-X23</td> <td>Low Angle Face Seal (3/4" - 16 threads)</td> <td>4.19</td> <td>1.62</td> <td>20,000</td> </tr>	HP010-0-X23	Low Angle Face Seal (3/4" - 16 threads)	4.19	1.62	20,000
HP010-0-X23	Low Angle Face Seal (3/4" - 16 threads)	4.19	1.62	20,000				

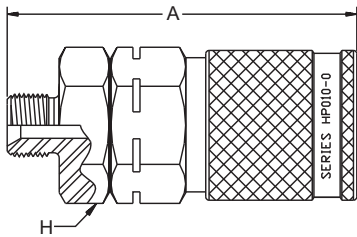

**HP010-0-A12,
 HP010-0-A16**

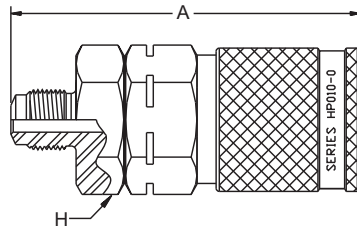

HP010-0-X23

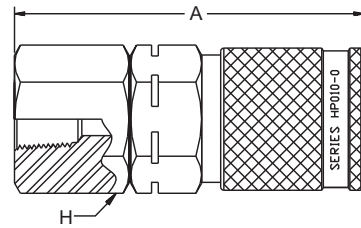

HP010-0-NFD

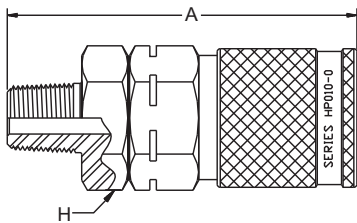

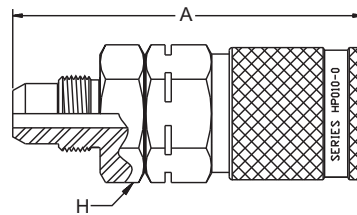

HP010-0-NMD



HP010-0-LM12

HP010
Nipple
Without Check Valve

Part Number	Connection Type	A Overall Length	H Hex Size	Maximum Working Pressure
#				
		inch	inch	psi
HP010-1-A12	Type "M" (3/4" - 16 threads)	2.40	1.06	20,000
HP010-1-A16	Type "M" (1" - 12 threads)	2.53	1.18	20,000
HP010-1-LM12	3/4" Medium Pressure Male	3.12	1.18	20,000
HP010-1-LM9	9/16" Medium Pressure Male	2.84	1.06	20,000
HP010-1-NMD	1/2" NPT Male	2.52	1.06	15,000
HP010-1-X23	Low Angle Face Seal (3/4" - 16 threads)	2.58	1.06	20,000

D

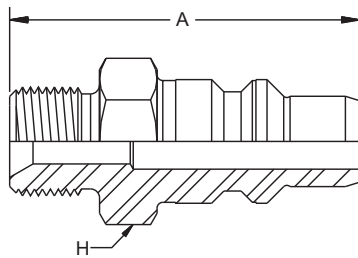

**HP010-1-A12,
 HP010-1-A16**

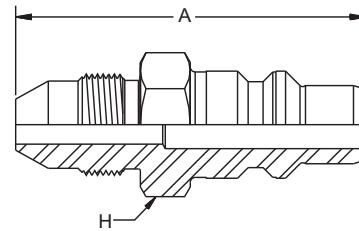

**HP010-1-LM9,
 HP010-1-LM12**

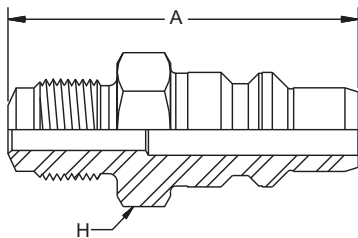

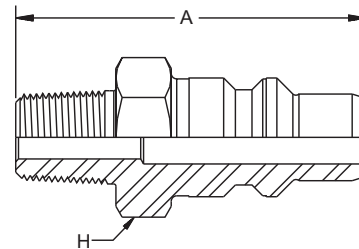

HP010-1-X23

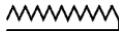

HP010-1-NMD

HP010
Nipple
With Check Valve

Part Number	Connection Type	A Overall Length	H Hex Size	Maximum Working Pressure
#				
		inch	inch	psi
HP010-2-A12	Type "M" (3/4" - 16 threads)	4.00	1.62	20,000
HP010-2-A16	Type "M" (1" - 12 threads)	4.08	1.62	20,000
HP010-2-NFD	1/2" NPT Female	4.14	1.62	15,000
HP010-2-NMD	1/2" NPT Male	4.13	1.62	15,000
HP010-2-X23	Low Angle Face Seal (3/4" - 16 threads)	4.18	1.62	20,000

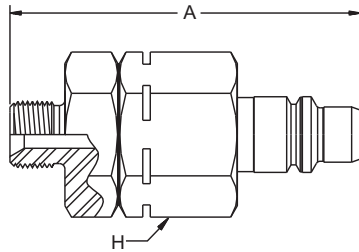

**HP010-2-A12,
 HP010-2-A16**

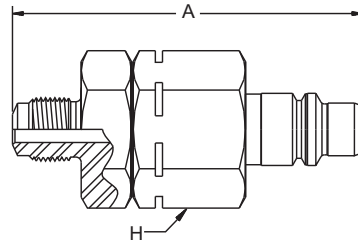

HP010-2-X23

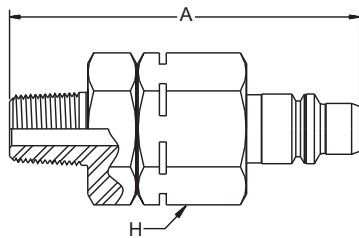

HP010-2-NMD

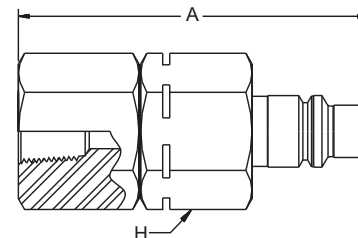

HP010-2-NFD

C Series

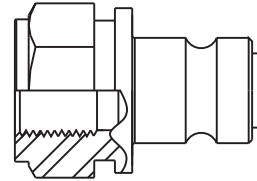
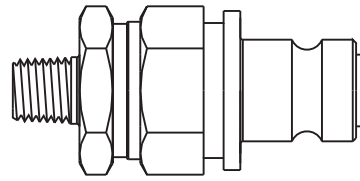
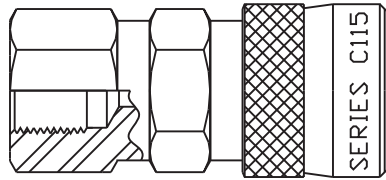

Features:

- Working pressures to 29,000 psi.
- Non-drip valving for clean, safe, trouble-free performance and minimal air inclusion.
- Built-in safety locking device to prevent accidental disconnect.
- Wide range of threaded styles NPT, BSP and “High Pressure”.
- Adaptors for ease of connection to high pressure hoses and fixed ports.
- Thread sizes from 1/8" to 3/8"
- Protective dust caps are included to prevent damage and fluid contamination in disconnected position.
- Rugged design and construction for long life in demanding applications.

Applications:

- Torque Tensioning
- Stud Tensioning
- Rescue
- Bearing Pullers
- Intensifiers
- Hydrostatic Testing
- Pumps
- Jacks
- Spreaders
- Cable Cutters
- Nut Splitters
- Pipe Coupling Swagers
- Presses
- Clamping Fictures
- Crimpers
- Blow-out Preventers

Type	Max. Working Pressure (psi)	Test Pressure (psi)	Nominal Thru Hole Diameter (in.)
C Series 115	14,500	21,800	0.11
C Series 116	21,800	29,200	0.11
C Series 125	29,800	36,300	0.11

NOTE: The choice of the threaded end form may limit the working pressure and the size of the thru hole in the coupling.

115

Coupler

Part Number	Connection Type	A Overall Length	H Hex Size	Maximum Working Pressure
#				
		inch	inch	psi
C10-115-1202	1/4" BSP Female (thru type)	2.30	0.94	14,500
C10-115-1222	1/4" BSP Female (with built-in locking device)	2.30	0.94	14,500
C10-115-1401	1/8" NPT Female	2.30	0.94	14,500
C10-115-1402	1/4" NPT Female	2.30	0.94	14,500
C10-115-1404	3/8" NPT Female	2.38	0.94	14,500
C10-115-1422	1/4" NPT Female (with built-in locking device)	2.30	0.94	14,500
C10-115-1452	1/4" NPT Male	2.45	0.94	14,500
C10-115-1454	3/8" NPT Male	2.45	0.94	14,500

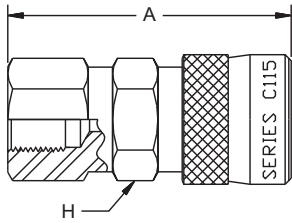

C10-115-1202

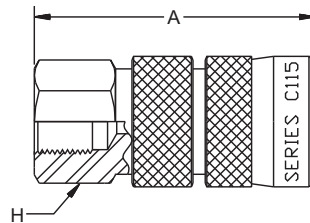

C10-115-1222

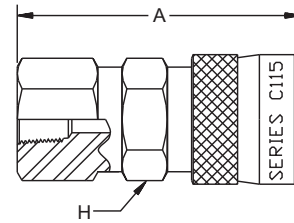

C10-115-1401

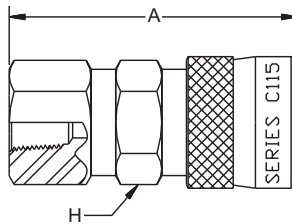

C10-115-1402

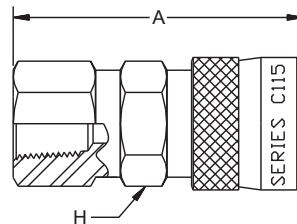

C10-115-1404

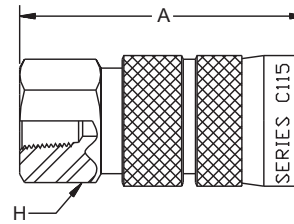

C10-115-1422

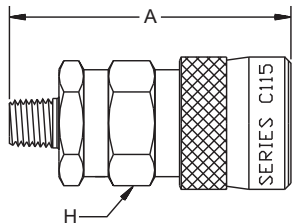

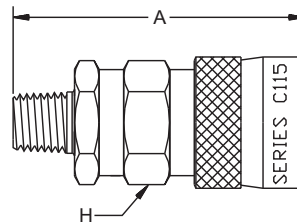

C10-115-1452



C10-115-1454

115

Nipple

Part Number	Connection Type	A Overall Length	H Hex Size	Maximum Working Pressure
#				
		inch	inch	psi
C10-115-6202	1/4" BSP Female	1.47	0.87	14,500
C10-115-6204	3/8" BSP Female	1.56	0.94	14,500
C10-115-6401	1/8" NPT Female	1.42	0.87	14,500
C10-115-6402	1/4" NPT Female	1.42	0.87	14,500
C10-115-6404	3/8" NPT Female	1.46	0.94	14,500
C10-115-6452	1/4" NPT Male	2.40	0.87	14,500
C10-115-6454	3/8" NPT Male	2.55	0.94	14,500

D

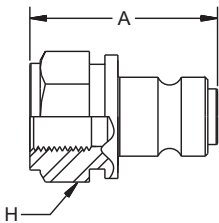

C10-115-6202

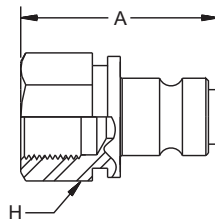

C10-115-6204

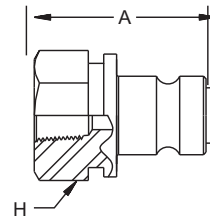

C10-115-6401

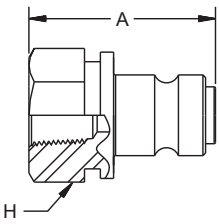

C10-115-6402

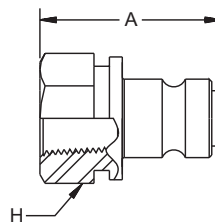

C10-115-6404

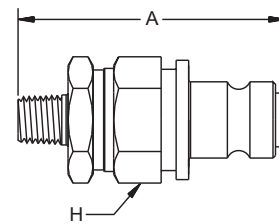

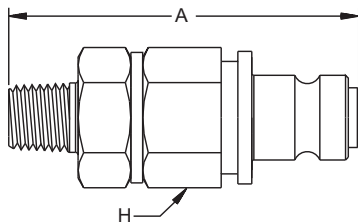

C10-115-6452



C10-115-6454

116

Coupler

Part Number	Connection Type	A Overall Length	H Hex Size	Maximum Working Pressure
#				
		inch	inch	psi
C10-116-1202	1/4" BSP Female	2.30	0.94	21,800
C10-116-1222	1/4" BSP Female (with built-in locking device)	2.30	0.94	21,800
C10-116-1402	1/4" NPT Female	2.30	0.94	15,000
C10-116-1422	1/4" NPT Female (with built-in locking device)	2.30	0.94	15,000

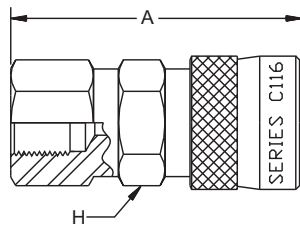

C10-116-1202

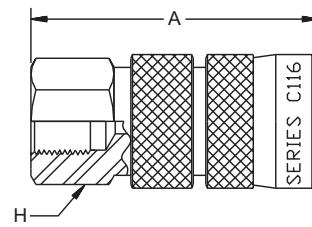

C10-116-1222

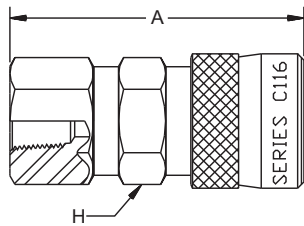

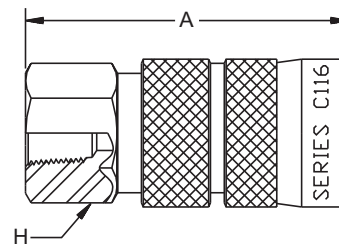

C10-116-1402



C10-116-1422

116

Nipple

Part Number	Connection Type	A Overall Length	H Hex Size	Maximum Working Pressure
#				
		inch	inch	psi
C10-116-5202	1/4" BSP Female (thru type)	1.47	0.87	21,800
C10-116-6202	1/4" BSP Female	1.47	0.87	21,800
C10-116-6402	1/4" NPT Female	1.41	0.87	15,000

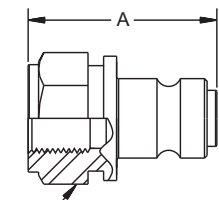

C10-116-5202

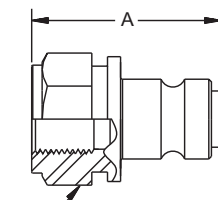

C10-116-6202

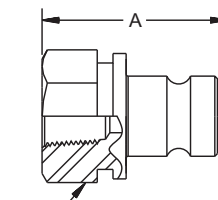



C10-116-6402

D

125

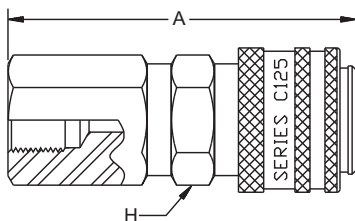

Coupler

Part Number	Connection Type	A Overall Length	H Hex Size	Maximum Working Pressure
#				
		inch	inch	psi
C10-125-1202	1/4" BSP Female	2.65	0.94	29,000



C10-125-1202

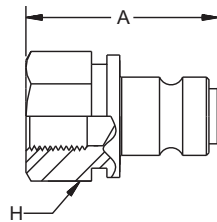

125 Nipple

Part Number	Connection Type	A Overall Length	H Hex Size	Maximum Working Pressure
#				
		inch	inch	psi
C10-125-5202	1/4" BSP Female (thru type)	1.50	0.87	29,000
C10-125-6202	1/4" BSP Female	1.50	0.87	29,000

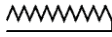

**C10-125-5202,
 C10-125-6202**

Quick Coupling Adapters

#		A Overall Length			
		inch	inch	inch	psi
C09-125-1680	1/4" BSP 120° external cone x 1/4" HP Male	1.72	0.67	29,000	
C19-950-0029	1/4" BSP 120° external cone x 9/16" UNF Hose	1.48	0.67	29,000	
C19-950-0062	1/4" BSP Rubber Metal Seal	0.08	0.81	14,500	
C19-950-0064	3/8" BSP Rubber Metal Seal	0.08	0.94	14,500	
C19-950-1600	1/4" BSP 120° external cone Blind Plug	1.07	0.67	29,000	
C19-950-1601	1/4" BSP x 1/4" BSP with 120° external cones	1.76	0.08	29,000	
C19-950-1602	1/4" BSP 120° external cone x 1/4" BSP 60° internal cone	1.54	0.83	29,000	
C19-950-1622	1/4" BSP x 1/4" BSP with 60° internal cones	1.25	0.83	29,000	
C19-950-1623	1/4" NPT Male x 1/4" BSP with 60° internal cone	1.27	0.83	14,500	
C19-950-1680	Porting Block	1.80		29,000	
HAHM4BM4	1/4" BSP with 60° internal cone x 1/4" HP Male	1.47	0.83	30,000	

D

Note: Using A Rubber Metal Seal Reduces The Working Pressure To 14,500 psi

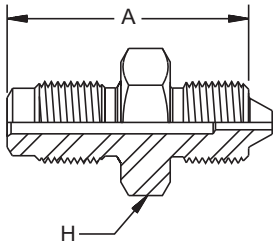

C09-125-1680

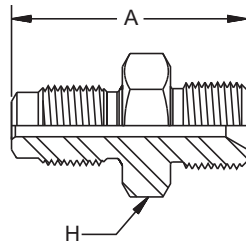

C19-950-0029

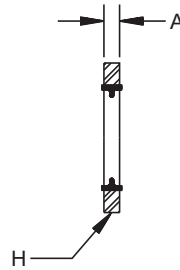

**C19-950-0062,
C19-950-0064**

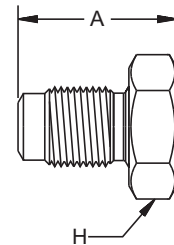

C19-950-1600

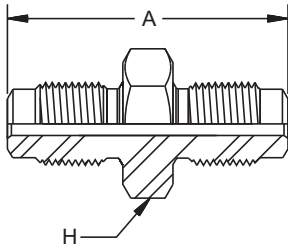

C19-950-1601

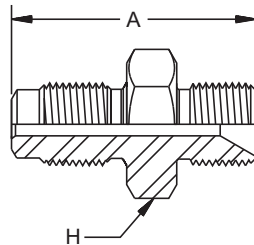

C19-950-1602

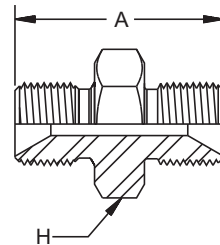

C19-950-1622

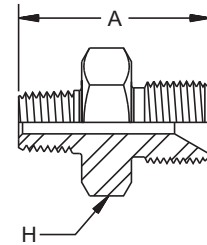

C19-950-1623

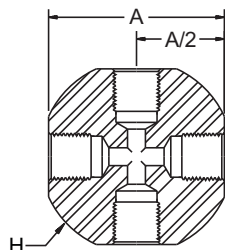

C19-950-1680

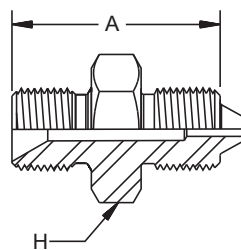

HAHM4BM4

WB Series

Applications

Parker's WB Series couplings are designed for equipment used in cleaning applications such as paint removal or mill scale. The 10,000 psi operating pressure of the WB series makes it ideal for applications that require a high pressure coupling with minimal pressure drop.

Features

- Push-to-Connect allows for quick, easy connections by eliminating the need to retract the sleeve to couple.
- Locking collets in the female half maintain 360 degree contact with male half to evenly distribute load and reduce brinelling.
- Zinc plating with yellow chromate finish resists corrosion.
- Straight through design allows for excellent flow with low pressure drop.
- Two knurled bands on the sleeve provide good gripping for operation of sleeve to disconnect.
- Sleeve Lock design prevents accidental disconnects.
- Stainless steel collets resist corrosion and provide smooth latching action.
- Teflon[®] backup washer ensures sealing integrity at high pressure.
- Induction hardened locking groove on the male half reduces wear and brinelling.
- Sleeve guard prevents accidental disconnect and seals the opening between the sleeve and the body from the environment.







Specifications

Body Size	1/2"
Temperature Range	-40°F to +250°F (-40°C to +121°C)
Maximum Operating Pressure	10,000 PSI (69 MPa)
Rated Flow	45 GPM (170 LPM)

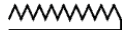
125

WB Coupler



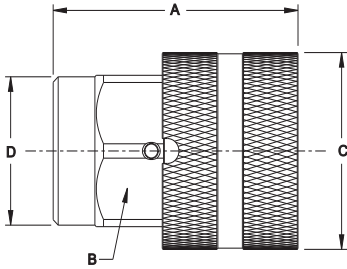

Part Number	Connection Type	A Overall Length	B Hex Size	C Largest Diameter	D Turned Diameter	Maximum Working Pressure
#						
WB-501-8FP	1/2-14 NPTF	inch 2.10	inch 1.25	inch 1.25	inch 1.25	psi 10,000



WB-501-8FP

125

WB Nipple

Part Number	Connection Type	E Overall Length	F Exposed Length	G Hex Size	H Largest Diameter	Maximum Working Pressure
#						
WB-502-8FP	1/2-14 NPTF	inch 2.35	inch 1.26	inch 1.13	inch 1.63	psi 10,000

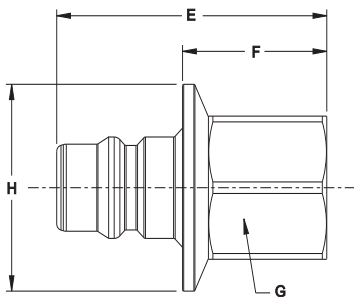

WB-502-8FP



Table of Contents

Heavy Duty Abrasion Cover	E2
Heavy Duty Abrasion Cover Sleeves	E2
Spring Guards	E2
Containment Grips	E2
Support Grips	E3
Bend Restrictors	E3
Anti-Gall Lubricant	E3
Pressure Containment Shield	E3
Dies, HP Fittings	E4
Dies, HP Guards	E4
Gauges, HP Fittings	E4
Dies, polyflex BOP Hose Fittings	E4
Karrykrimp	E5
Parkrimp I and II	E5

E

Heavy Duty Abrasion Cover



Part No.	Description
#	
MHDC010	5/8" I.D. Clear Vinyl
MHDC011	5/8" I.D. Clear Vinyl with white Helix reinforcement
MHDC012	3/4" I.D. Clear Vinyl with white Helix reinforcement
MHDC014	7/8" I.D. Clear Vinyl with white Helix reinforcement
MHDC016	1" I.D. Clear Vinyl with white Helix reinforcement
MHDC018	1-1/8" I.D. Clear Vinyl with white Helix reinforcement
MHDC020	1-1/4" I.D. Clear Vinyl with white Helix reinforcement
MHDC022	1-3/8" I.D. Clear Vinyl with white Helix reinforcement
MHDC024	1-1/2" I.D. Clear Vinyl with white Helix reinforcement
MHDC026	1-5/8" I.D. Clear Vinyl with white Helix reinforcement
MHDC032	2" I.D. Clear Vinyl with white Helix reinforcement

Spring Guards



Part No.	Description
#	
MSG060	0.60" I.D. Continuous Spring
MSG1006	For 2040N-04V00 Hose
MSG2006	For 2245N-04V00 Hose
MSG2106	For 2380N-04v00 Hose
MSG4113	For -8 Hoses
MSG4120	For 2440N-12V37 Hose
MSG4125	For 2440N-16V37 Hose
MSG6020	For 2640N-12v32 Hose

Heavy Duty Abrasion Cover Sleeves



Part No.	Abrasion Cover Used On...
#	
508-J-500-10	MHDC010, MHDC011
510-A-500-12	MHDC012
612-400-14	MHDC014
216-200-18	MHDC016, MHDC018
620-100-18	MHDC018 (w/2640N-08 hose)
220-200-22	MHDC022, MHDC024
520-A-500-26	MHDC026

Containment Grips



Part No.	Description
#	
MCG001SS	For Hose O.D. 0.38" - 0.69"
MCG002SS	For Hose O.D. 1.0" - 1.56"
MCG003SS	For Hose O.D. 1.25" - 1.94"
MCG005SS	For Hose O.D. 0.75" - 1.25"
MCGHS10-15	For Hose O.D. 0.40" - 0.59"
MCGHS15-20	For Hose O.D. 0.59" - 0.79"
MCGHS20-30	For Hose O.D. 0.79" - 1.18"
MCGHS30-40	For Hose O.D. 1.18" - 1.57"
MCGHS40-50	For Hose O.D. 1.57" - 1.96"
MCGHS50-60	For Hose O.D. 1.96" - 2.36"

Black Eagle® Support Grip

Part No.	Description
#	
MCG014-02-1523	For Hose O.D. 2.25" - 2.94"
MSG014-02-1524	For Hose O.D. 2.75" - 3.44"

Support Grips

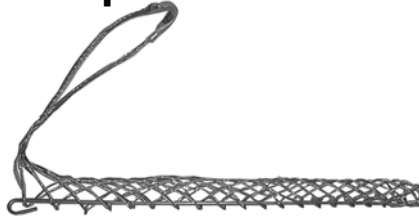

Part No.	Description
#	
MK022-03-038	For Hose O.D. 0.63" - 0.74"
MK022-03-039	For Hose O.D. 0.75" - 0.99"
MK022-03-041	For Hose O.D. 1.00" - 1.24"
MK022-03-042	For Hose O.D. 1.25" - 1.49"
MK022-03-043	For Hose O.D. 1.50" - 1.74"
MK022-03-045	For Hose O.D. 2.25" - 2.49"

Bend Restrictors



Part No.	Description
#	
MBR003	Molded Vinyl 0.25" I.D.
MBR007	Molded Vinyl 0.41" I.D.
MBR008	Molded Vinyl 0.50" I.D.
MBR009	Molded Vinyl 0.562" I.D.
MBR010	Molded Vinyl 0.625" I.D.
MBR012	Molded Vinyl 0.77" I.D.
MBR013-B	Molded Plastic for 2840D-03V32 hose
MBR2104	Molded Vinyl for 2244N-025V00 hose
HG8X-04	Molded Plastic for 2380N-4Vxx hose

E

ThreadMate™ Anti-Gall Lubricant



Part No.	Description
#	
MTM04T	4-oz Tube

- ThreadMate is an extreme duty lubricant developed to reduce galling during the assembly of threaded parts.
- ThreadMate promotes reliable sealing of pipe threads even at high pressure by reducing friction and galling during tightening, resulting in higher contact pressures of the sealing surfaces, and better metal-to-metal contact.
- ThreadMate reduces the torque needed to make pressure tight connections and tighten fasteners.

Pressure Safety Shield

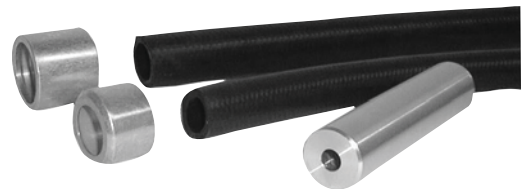

Part No.	Description
#	
* MHBS012	3/4" I.D. Rubber Safety Shield
612-400-14	Pressure Safety Shield Retaining Sleeve
M55STIF4	Pressure Safety Shield Stiffener HP Tube Fitting
M55STIF6	Pressure Safety Shield Stiffener Type "M" Fitting
* Designated for the 2740D-03V30 and the 2840D-03V34 Hoses.	
** MHBS016	1" I.D. Pressure Safety Shield
416-400-16	Pressure Safety Shield Sleeve
** Designated for the 2740D-05V32 and the 2840D-05V32 Hoses.	

Dies, HP Fittings

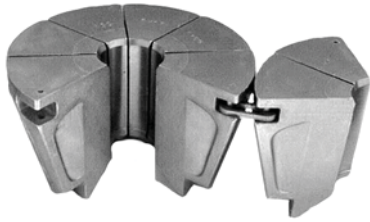

Part No.	Description
#	
80C-HP3	Dies for HP3 Fittings
80C-HP4	Dies for HP4 Fittings
80C-HP6	Dies for HP6 Fittings

Dies, HP Guards

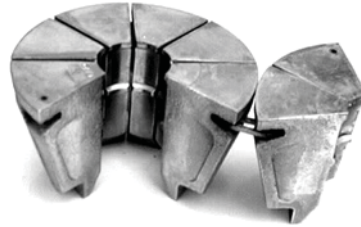

Part No.	Description
#	
80C-G03	Dies for HP3 Guards
80C-G04	Dies for HP4 Guards
80C-G06	Dies for HP6 Guards

Gauges, HP Fittings

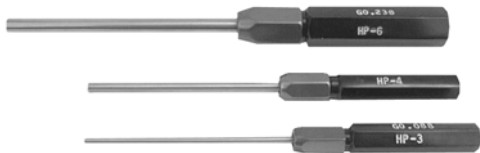

Part No.	Description
#	
HP-3-Gauge	Gauge for HP-3 Fittings
HP-4-Gauge	Gauge for HP-4 Fittings
HP-6-Gauge	Gauge for HP-6 Fittings

Dies for **polyflex Hose**

- 2390N Hose Series
- 2245N Hose Series
- 57CR Seawolf™



Part No.	Description	Fitting Series
#	Hose Types	Series
83C-9X04	2390N-04	9x
83C-9X08	2390N-08	9X
83C-9X16	2390N-16	9X
80C-F04G	2245N-04V00	55
80C-F06G	2245N-06V00	58
80C-F08G	2245N-08V00	58
80C-F10G	2245N-10V30	58
80C-F12G	2245N-12V30	58
83C-F16G	2245N-16V30	58
80C-F08W	57CRN-08V	CR
83C-F16W	57CRN-16v	CR

Parkrimp I

Parkrimp I offers hose assembly capability through 1-1/4", SAE 100R1, 100R2, 100R7, 100R8, 100R9 and 100R14. Its design provides you with the ability to crimp straight – as well as bent tube hose ends; a full power return cycle allows quick, easy size and hose type changes, while the die pusher automatically moves out of the way for easy die insertion: Bench mounted at a 20° angle lets you load and unload hydraulic assemblies as easily as possible. Parkrimp I gives you the ease and flexibility to manufacture hydraulic hose assemblies you require – and in less than ten seconds.

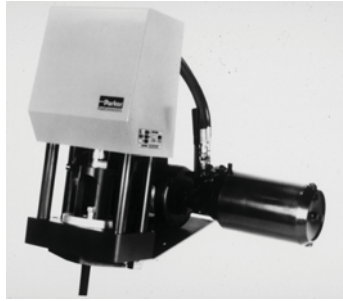

- Part No.**
80C-001-PFD Machine with power unit, silver die ring and dies 80C-P04, P06, P08, P12
80C-081-PFD Machine with power unit and without silver die ring and dies
80C-R01-PFD Silver die ring

Parkrimp II

Parkrimp II provides you with total capability to manufacture hydraulic hose assemblies up through 2". Parkrimp II's advanced design – with capacity to handle 100R1 through 100R14 hose types, coupled with straight or bent tube ends – is the industry's leading edge in the manufacture of hydraulic hose assemblies. Unparalleled in its design, Parkrimp II needs no special adjustments or gauge settings. Simply insert the unitized or split die train for the appropriate size – and with push button ease you have factory-quality assemblies in just seconds.



Part No. 83C-081-PFD

MiniKrimp™



Standard Equipment

Model 94C-001-PFD includes:

Part Number	Part Description
94C-080-PFD	MiniKrimp™ Portable Crimping Machine
015301	Hand Pump
82C-R01-PFD	Die Ring – Color Coded Silver

Optional Equipment

Part Number	Part Description
015736	Side Vise Mount
015306	Upright Table Mount
015307	Upright Vise Mount
82C-R02-PFD	Die Ring – Color Coded Black
015309	Hose Assembly
015308	Replacement Tube Assembly w/o Fittings



Table of Contents

polyflex Hose — Determination of Length
of Hose for Over-the-Sheave Applications F2

Installation Tips F3

Recommended Practice for Selection, Installation,
and Maintenance of **polyflex** Hose Assemblies F4

Dash Size Systems for Hose and Tubing F5

Selection of Hose Diameter F6

Twin/Multi-Line Separation Instructions F8

Volumetric Expansion Data F9

Pressure Drop vs. Flow F10

Government & Agency Approvals F15

Glossary F16

Gas Permeability of Plastics F17

Recommended Tightening Procedures F18

Metric Conversions F19

Chemical Resistance F20

Parker Safety Guide F25



Installation Tips

polyflex Hose —

Determination of Length of Hose for Over-the-Sheave Applications

The exact cutoff length for an optimum over-the-sheave assembly depends on the particular mechanical arrangement of the machine. A method for finding an approximate starting point is as follows:

1. Assemble hose with one coupling as shown in diagram.
2. Measure hose length from point 1 to point 2 **with hose taut**. (L_o = length)
3. Calculate hose cutoff or free length L_F :
 $L_F = 0.985 L_o + 2x$
Where L_F includes coupling insert allowance on both ends. The coupling insert allowance (x) may be found from the coupling dimension tabulations in the fittings sections section of this fitting section or from direct measurement on the coupling. A 1.5% stretch allowance is provided in this formula.
4. Couple the remaining hose end and assemble on the machine.

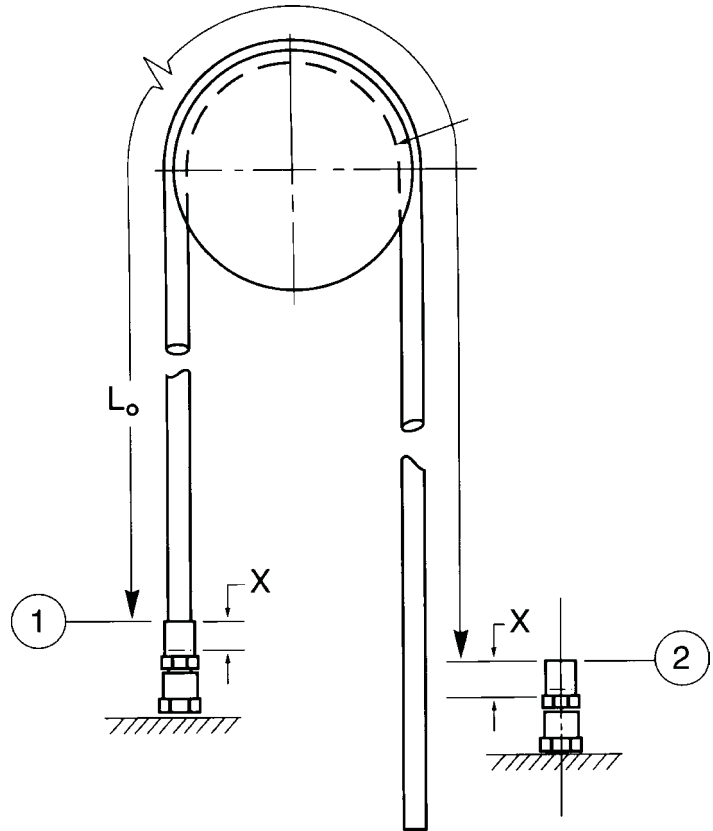

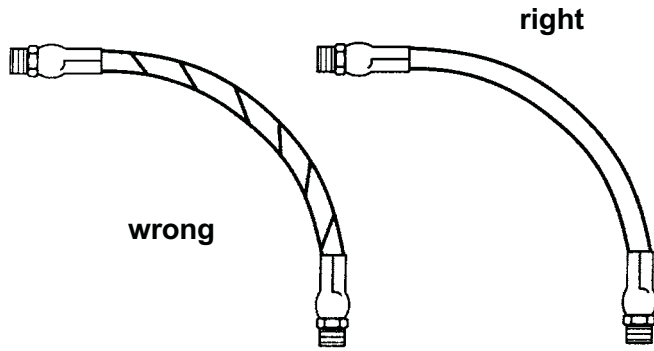

Hose is weakened when installed in twisted position. Also, pressure pulses in twisted hose tends to fatigue wire and loosen fitting connections. Design so that machine motion produces bending rather than torsion.

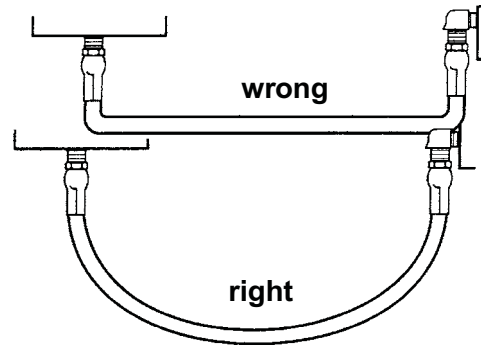

Hose should exit coupling in a straight position rather than side loaded. Ample bend radius should be provided to avoid collapsing of hose and flow restriction. Exceeding minimum bend radius will greatly reduce hose assembly life.

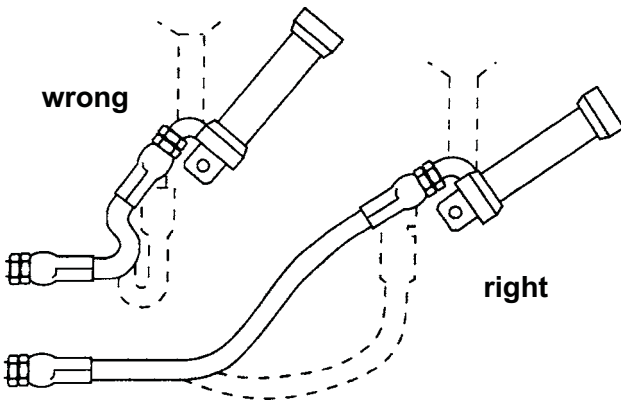

When hose assembly is installed in a flexing application, remember that metal hose fittings are not part of the flexible portion. Allow ample free length for flexing.

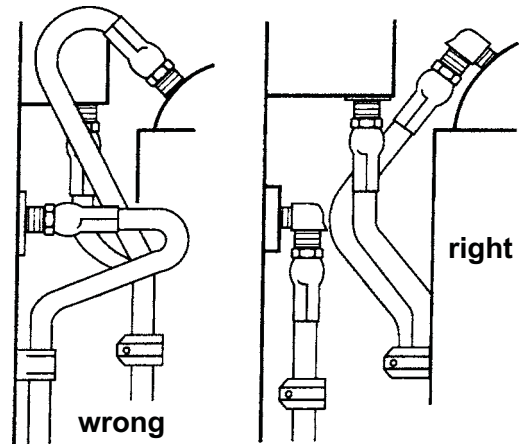

Use elbows or other adapters as necessary to eliminate excess hose length and to ensure neater installation for easier maintenance.

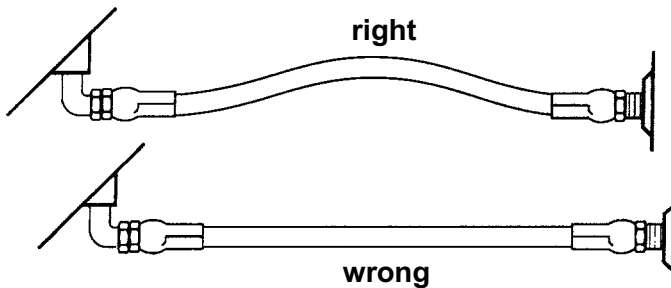

Pressure can change hose length as much as $\pm 3\%$. Provide slack in line to compensate for hose length changes.

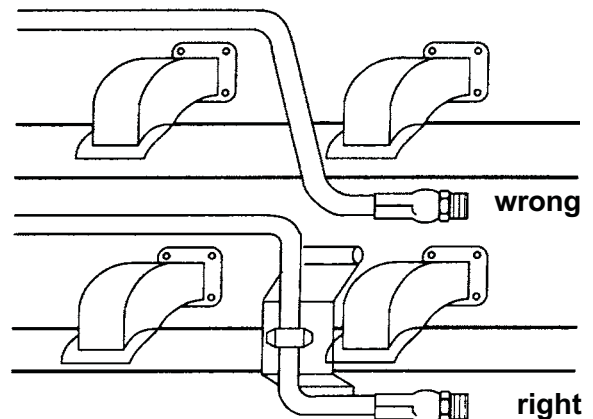

Avoid installing hose line close to exhaust manifold or any other hot section. If possible, isolate hose with fireproof boot or other protective means.

F

Recommended Practice for Selection, Installation, and Maintenance of **polyflex** Hose and Hose Assemblies

Hose and hose assemblies have a finite life span and many things reduce this time. This recommended practice should be read by designers and users of hose to assist them in the proper selection of hose. These guidelines, while not all inclusive, will assist the user in maintaining hydraulic and pneumatic systems.

READ THE PARKER SAFETY GUIDE CONTAINED IN THIS CATALOG IN ITS ENTIRETY.

PART ONE – How to Select Hose

- **Pressure** – Maximum operating pressure of the hose must be greater than or equal to the system pressure. Pressure surges or system “spikes” in excess of the maximum operating pressure will shorten hose life and must be avoided.
- **Temperature** – Ambient and fluid temperatures must not exceed the hose/fittings rated design temperature. Attempt to route hose or shield hose from high temperature sources.
- **Size** – Adequately size hose and fittings to avoid damaging hose with excessive turbulence, or heat build-up, while maintaining proper flow and pressure. (Refer to fluid velocity nomogram.)
- **Fluid compatibility** – Refer to Chemical Compatibility Guide in this catalog for use of fluids with various materials. If unsure of an application, contact the factory. Additional care must be taken with gaseous applications. (See Safety Guide at end of catalog.)
- **Environment** – Conditions such as ozone, UV light, harsh chemicals, salt water, and other airborne contaminants can degrade hose and shorten its life.
- **Length** – Hose length changes with pressure. This, along with equipment movement, must be considered in the system design.
- **Proper couplings** – Always follow manufacturers specifications and do not mix components of different manufacturers.
- **Mechanical loads** – Conditions such as tensile and side loads, vibration, excessive flexing, and twist will reduce hose life. Use swivel fittings and adapters to avoid hose twisting. Test the hose if the application is potentially problematic or unusual.
- **Electrical conductivity** – Determine if the hose must be non-conductive to prevent electrical current flow or conductive to dissipate static electricity. Choose hose and fittings accordingly. (See Safety Guide for Electrical Conductivity issues.)

PART TWO – Installation and Maintenance

- **Inspect components** – Check hose for cover cracks, blisters, cleanliness, kinks, cracks or core tube obstructions or other defects. Examine fittings for poor threads, obstructions, cracks, rust. Do not use hose or fittings if these problems exist.
- **Assemble per instructions contained in this catalog.**
- **Do not exceed specified minimum bend radius** – Use stress relievers to prevent sharp bends at the hose and fitting juncture. These can be spring guards or other stress relieving members.
- **Ensure that hose bends rather than twists with equipment motion.**
- **Use a torque wrench or the flats from finger tight method to properly install port connections.**
- **After installation, eliminate air entrapped in system, pressurize to maximum operating pressure, and check for leaks and proper system function.**
- **After installation, periodically (frequency depends on severity of application and potential risk) inspect the system for the following:**
 1. Blistered, degraded, or loose hose covers.
 2. Stiff, cracked, or charred hose.
 3. Cuts or abrasion of hose. Look for exposed reinforcement.
 4. Leaks in hose or fittings.
 5. Damaged or corroded fittings.
 6. Excessive build up of dirt, grease, oils, etc.
 7. Defective or broken clamping devices, shields.
 8. Kinks in hoses.

Upon discovery of any of these items, replace it, repair it, but **DO NOT IGNORE IT!**
- Retest the system after all maintenance procedures.
- Establish replacement schedules based on previous service life, or when failures could result in damage, personal injury, excessive or unacceptable downtime.

Dash Sizes

Dash sizes are commonly used to designate hose I. D., plastic tubing and metal tubing O. D. and coupling size. Dash size systems in common use:

Nominal Hose I. D. or Tubing O. D.		Dash Number for all polyflex Hose	Dash Number for TFE Hose	Nominal DIN Size
Inches	Millimeters			
3/32	2.0	-012		
1/8	3.2	-2	-	-
3/16	4.8	-3	-4	5
1/4	6.3	-4	-5	6
5/16	7.9	-5	-6	8
3/8	9.5	-6	-	10
13/32	10.3	-6.5	-8	-
1/2	12.7	-8	-10	12
5/8	15.9	-10	-12	16
3/4	19.1	-12	-	20
7/8	22.2	-14	-16	-
1	25.4	-16	-	25
1-1/8	28.6	-	-20	-
1-1/4	31.8	-20	-	32
1-3/8	34.9	-	-24	-
1-1/2	38.1	-24	-	40
1-13/16	46.0	-	-32	-
2	50.8	-32	-	50

F

Selection of Hose Diameter from Flow Rate and Velocity

The Fluid Velocity Nomogram gives the velocity of a liquid or gas as a function of flow rate and inside diameter of the fluid line. The commonly recommended maximum velocities for hydraulic oil systems at 200°F or less are indicated for guidance.

Example: At 10 gpm, what is the minimum size within the recommended velocity range for a hydraulic pressure line?

The dashed line drawn from the 10 gpm mark on the left hand line to the maximum velocity of 20 fps intersects the middle line at .438 " (7/16" I. D. hose or tubing).

For a hose application, use 1/2" I. D., the nearest common standard size.

This chart is based on the following formulas: $v_{fps} = \frac{.321Q}{\frac{pd^2}{4}}$, Q = gal per min
 d = hose or tube I. D. (inch)

$$\text{cu. ft./min.} = .1337 Q$$

The cu. ft. per min. value is the actual volume flow rate under flowing conditions.
 For air, standard cfm of free air = 7.81 actual cfm when the inlet air is at 100 psig, 68°F.

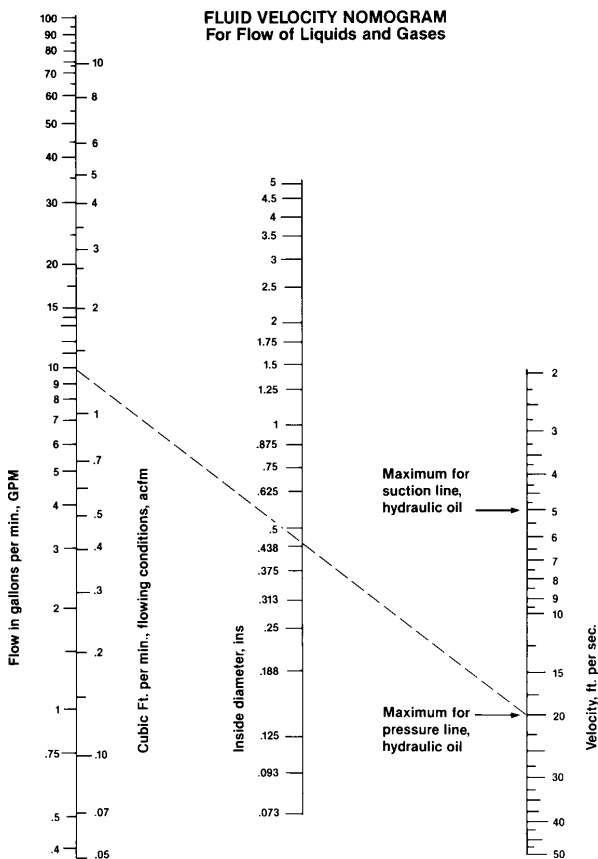

Determination of Pressure Drop in the Line

$$\text{Velocity: } v = .409 \frac{Q}{d^2} = .0509 \frac{W}{pd^2} = \frac{q}{.785d^2}$$

$$\text{Reynold's Number: } Re = 124 \frac{dvp}{\mu} = 6.31 \frac{W}{d\mu} = 378 \frac{qp}{d\mu}$$

Pressure Drop, Isothermal, Incompressible Flow (Liquids):

$$\Delta P = .001294 \frac{fLpv^2}{d} = .00000336 \frac{fLW^2}{pd^5} = .0121 \frac{fLq^2}{d^5}$$

Pressure Drop, Isothermal, Compressible, Long Lines (Gases and Vapors):

$$\frac{\Delta P}{P_1} = 1 - \sqrt{1 - \frac{fLp_1v_1^2}{12gdP_1}}$$

Symbols and Units for Listed Formulas

d = inside diameter of hose, inches

f = friction coefficient, dimensionless

g = gravitational constant, 32.2 ft./sec.²

P₁ = input pressure, psi

ΔP = pressure difference, psi

q = rate of flow at flowing condition, cu. ft./min.

Q = rate of flow, gals./min.

Re = Reynolds number, dimensionless

v = flow velocity, ft./sec.

W = rate of flow, lbs./hr.

p = weight density of fluid, lbs./cu. ft.

μ = absolute (dynamic) viscosity, centipoises

Twin Line and Multi-Line Separation Instructions

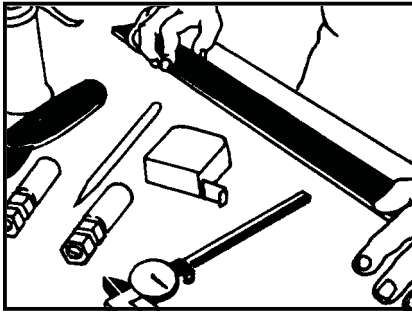

1. Position twinned or multi-line hose assembly so that it lies flat on work surface without tendency to twist or turn.

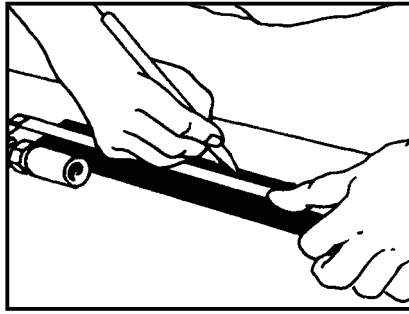

2. Measure and mark the length that the hoses are to be separated. **Note:** if length of separation is specified from the threaded or swivel nut end of coupling, deduct the cutoff allowance dimension for the specific style of coupling used. The cutoff allowance is obtainable from the hose fitting tables found in the hose fitting tables or can be calculated by subtracting the insertion depth of the shell from the overall coupling length.

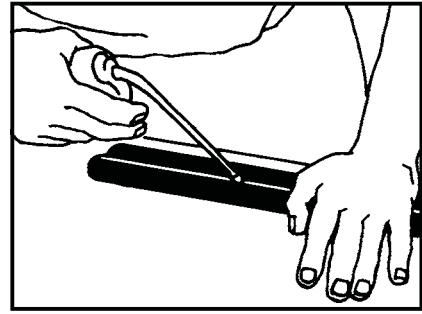

3. Lightly lubricate the web area between the hoses. Distribute the lubricant uniformly along the web of the assembly to be separated. Parker Hoze-Oil or any lightweight oil will suffice. (SAE 10 or 20) The function of the oil is to reduce the friction of the knife blade so that it naturally seeks the center of the valley formed by the hoses. This eliminates the need for the operator to steer the knife.

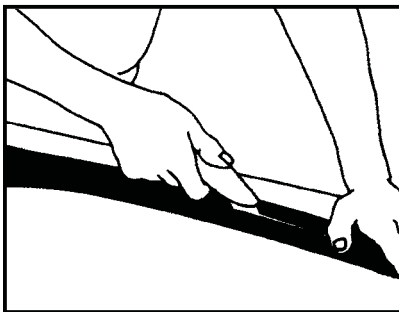

4. Press the multi-line hose assembly firmly and flat against the work surface with your free hand so that it does not move. Using a Stanley trimming knife model No. 10-515 or equivalent, draw the knife toward you with constant light to moderate pressure, and a smooth stroke. Three or four strokes will be necessary to separate the hoses.

NOTE:

- It is important that the knife blade be perpendicular to the hose during this procedure so that the blade cuts only the center line of the web. **EXTREME CARE MUST BE TAKEN TO AVOID CUTTING THROUGH THE COVER OF THE HOSES AND THEREBY EXPOSING THE FIBER REINFORCEMENT.** If this occurs, the hose assembly must be discarded. (see photo A.)

If the separation length is greater than that which can be accomplished with one continuous, smooth stroke, then the procedure should be repeated over shorter distances always cutting toward the free end of the hoses.

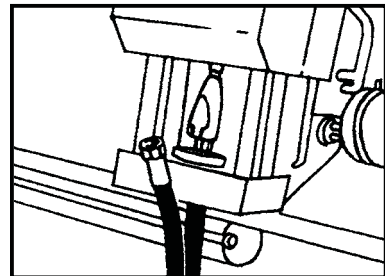

5. It is suggested that the separation length be sufficiently long so that the swaging or crimping operation can be accomplished without risk of kinking the hoses or tearing the web which could result in exposure of the braided reinforcement. (see photo B)

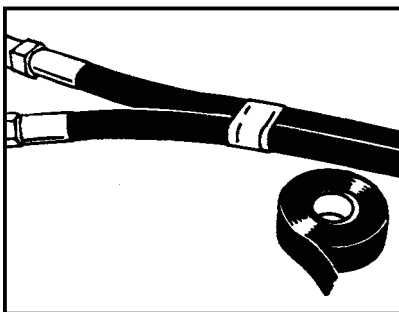

6. At the option of the assembler as dictated by the installation, it is suggested that a nylon lashing strap or tape be applied at the termination of the separated length to provide protection against tearing of the web or hose covers.

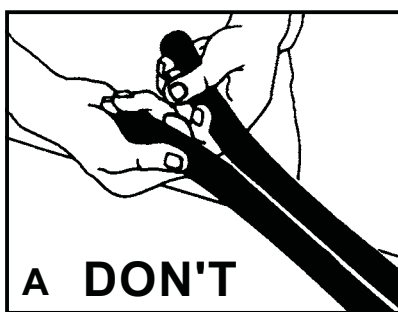

EXTREME CARE MUST BE TAKEN TO AVOID CUTTING THROUGH THE COVER OF THE HOSES AND THEREBY EXPOSING THE REINFORCEMENT. If this occurs, the hose assembly must be discarded.

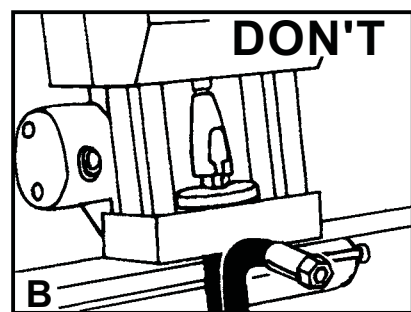

The separation length must allow for the swaging or crimping operation without damaging the hose.

Volumetric Expansion Data For HP/HP8 Thermoplastic Hose

(▲ indicates hose working pressure)

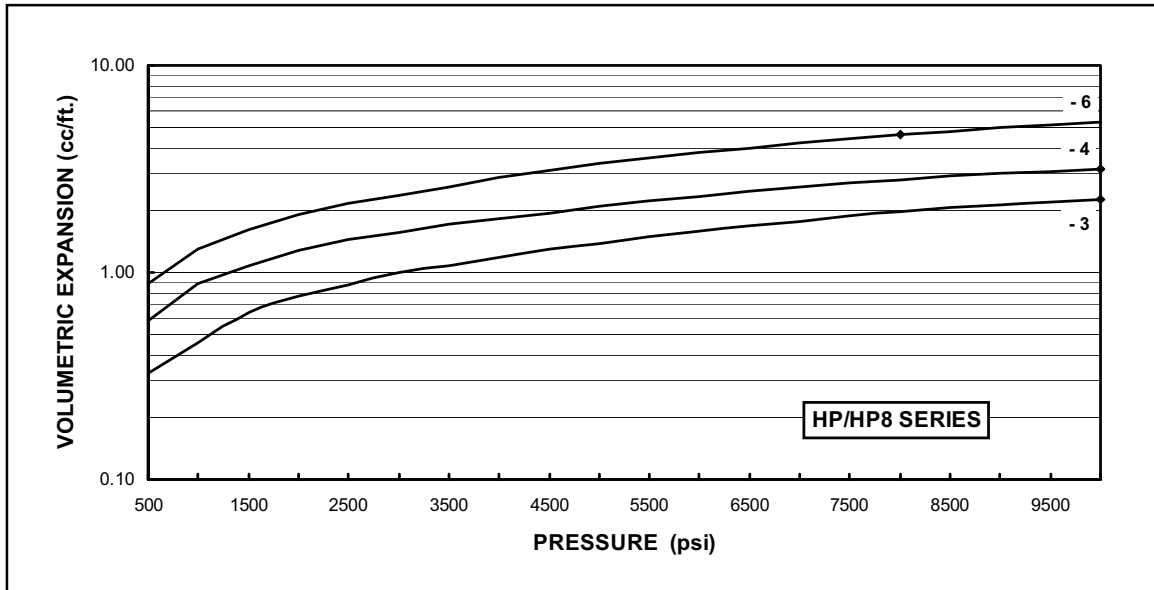

F

For Hose Types:
2040N-02V00 (1003 K)
2020N-02V30 (1003 MK)
2240D-02V32 (2003 STR)

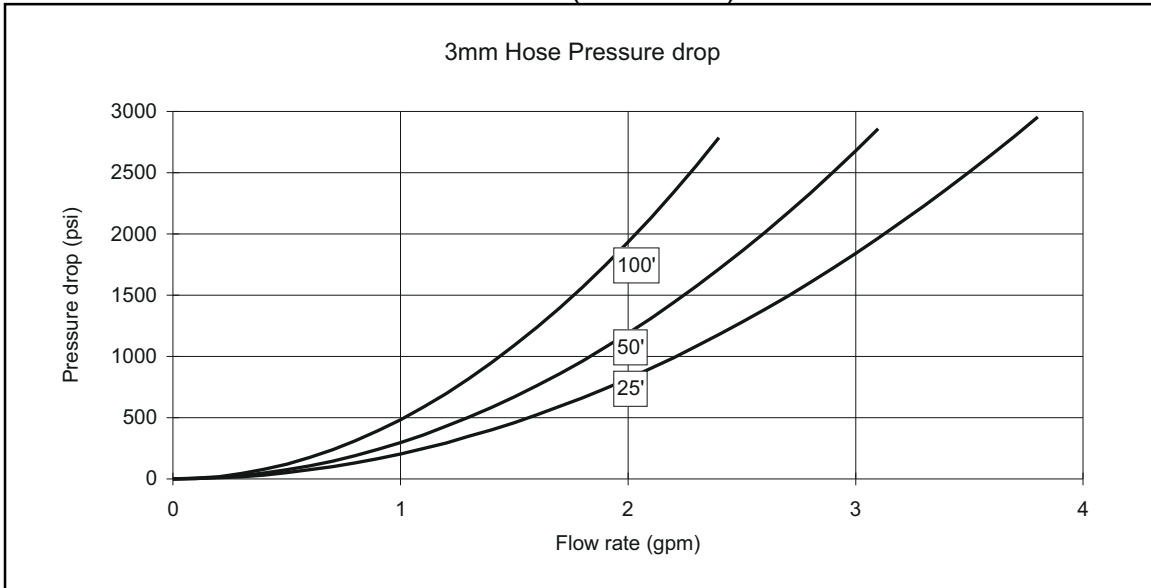

For Hose Types:

2240D-025V34 (2004 STR)	2440D-025V37 (4004 ST)
2243D-025V70 (2004 STV)	2640D-025V32 (6004 ST)
2244N-025V00 (2104 ST)	2740D-025V30 (6104 ST)

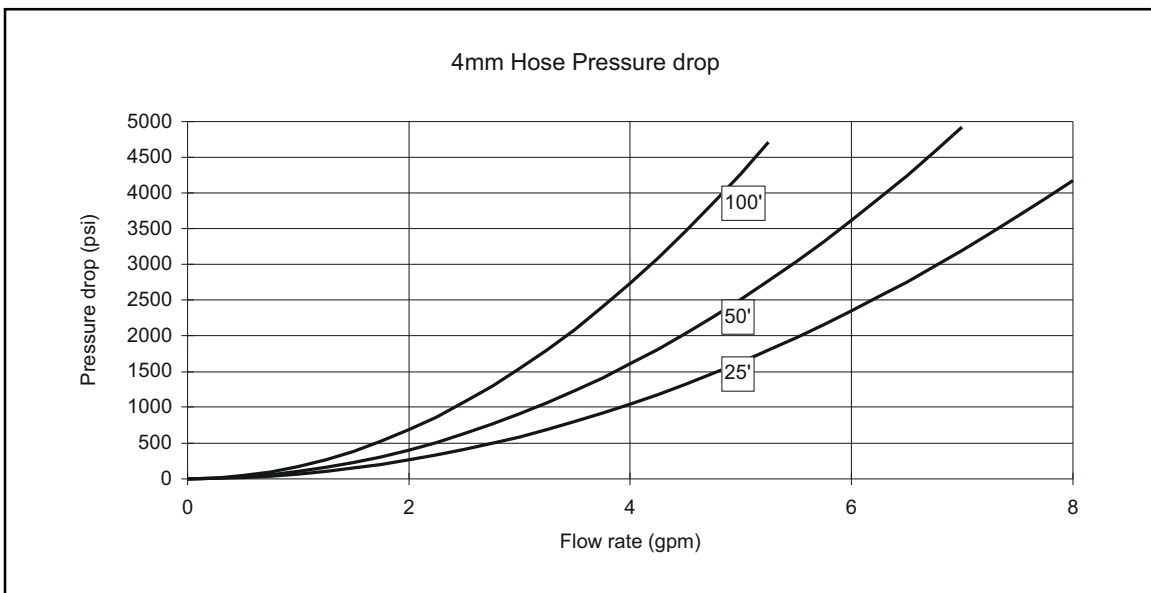

Results obtained from actual pressure drop tests, pumping water through hose assemblies with normal end fittings.

For Hose Types:

- | | |
|-------------------------------|------------------------------|
| 2240D-03V32 (2005 STS) | 2440D-03V37 (4005ST) |
| 2245D-03V32 (2005 STR) | 2640D-03V32 (6005 ST) |
| 2243D-03V70 (2005 STV) | 2740D-03V30 (6105 ST) |

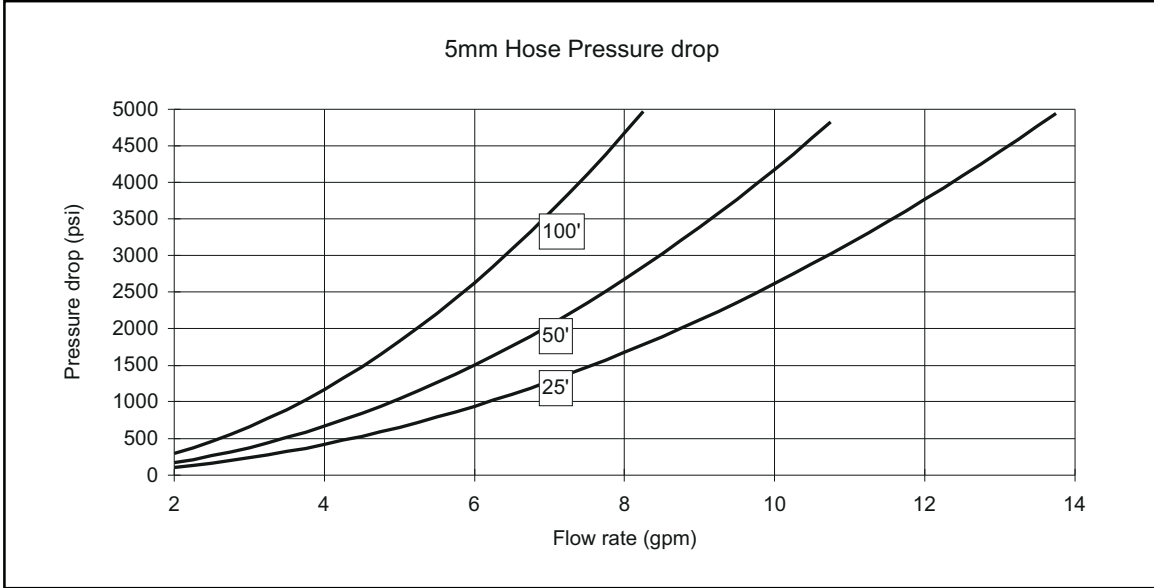

For Hose:
2840D-03V34 (8005 ST)

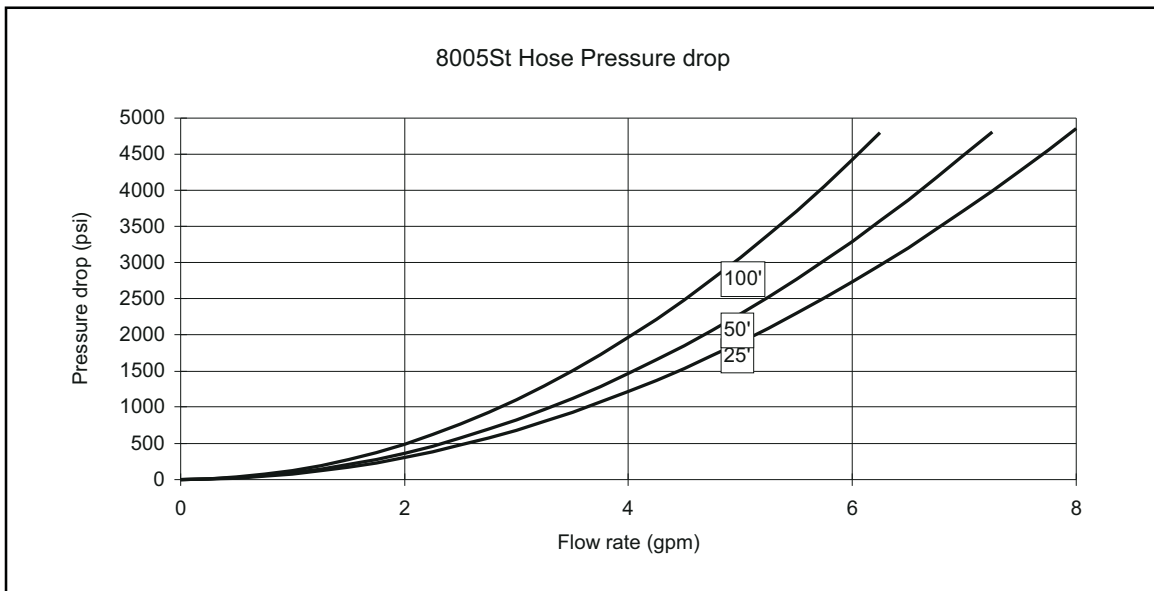

Results obtained from actual pressure drop tests, pumping water through hose assemblies with normal end fittings.

For Hose Types:

- | | |
|-------------------------------|--------------------------------|
| 2245N-04V00 (2006 ST) | 2380N-04V00 (2106 ST) |
| 2380N-04V33 (2006 STA) | 2380M-04V00 (ChemJec) |
| 390N-04V00 (2206 ST) | 2240D-04V32 (2006 STS) |
| 2440N-04V37 (4006ST) | 2X90N-04V14 (Red Snake) |
| 2440M-04V30 (ChemJec) | |

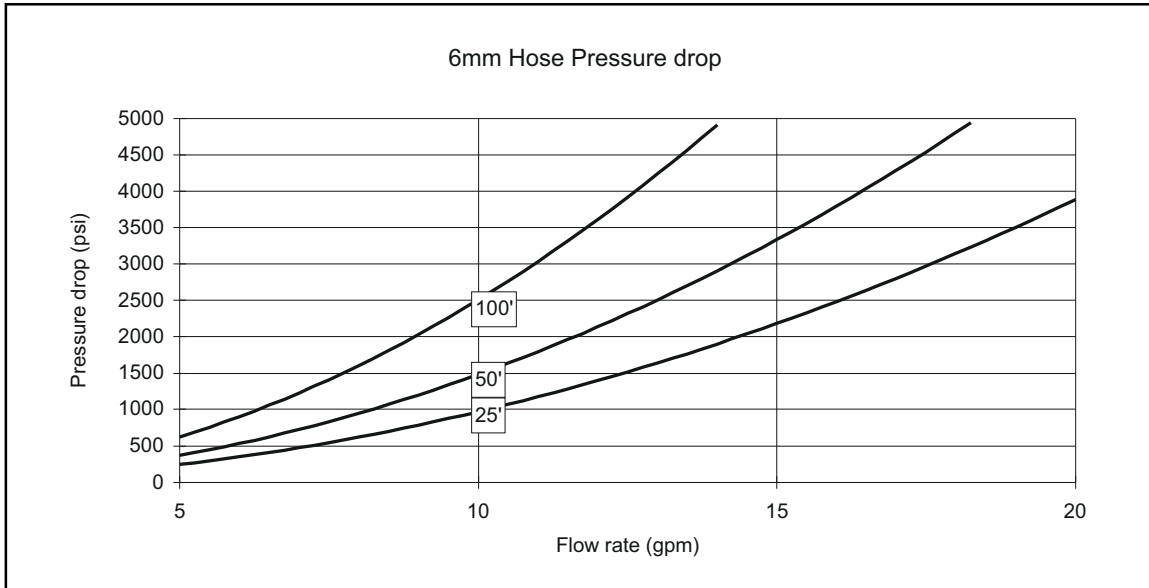

For Hose Types:

- | | |
|-------------------------------|------------------------------|
| 2240N-05V32 (2008 STS) | 2440D-05V37 (4008 ST) |
| 2380F-05V07 (FEP) | 2640D-05V32 (6008 ST) |
| 2380M-05V30 (ChemJec) | 2740D-05V32 (6108 ST) |
| 2440M-05V30 (ChemJec) | 2840D-05V32 (8108 ST) |

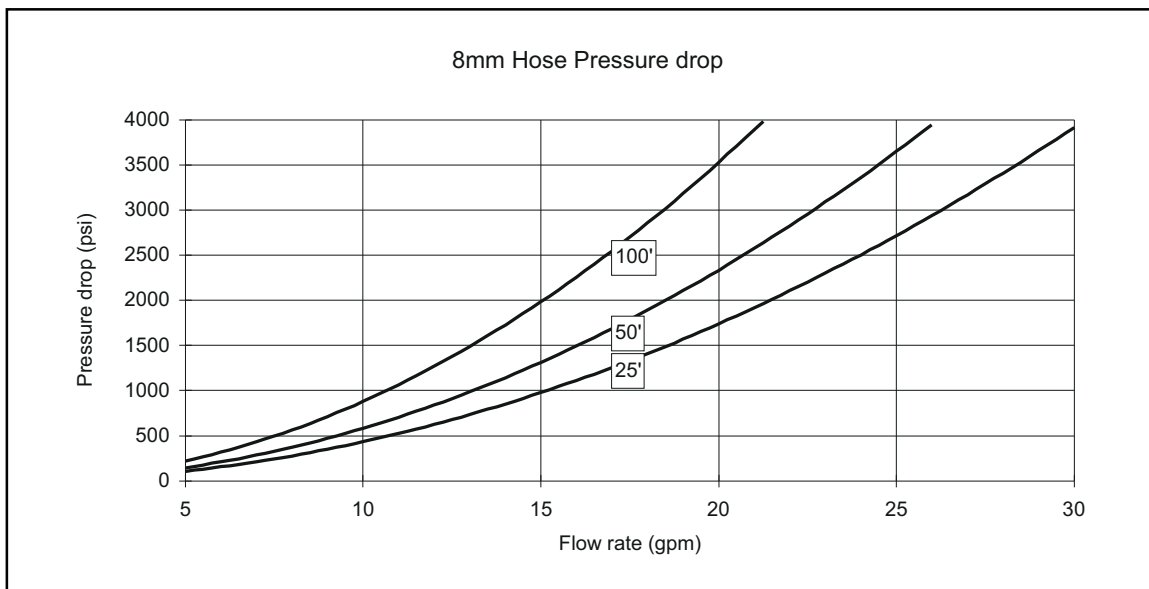

Results obtained from actual pressure drop tests, pumping water through hose assemblies with normal end fittings.

For Hose Types:

- | | |
|------------------------------|--------------------------------|
| 2245N-06V30 (2010 ST) | 2X90N-06V14 (Red Snake) |
| 2390N-06V13 (2210 ST) | 2440N-06V91 (4110 STN) |

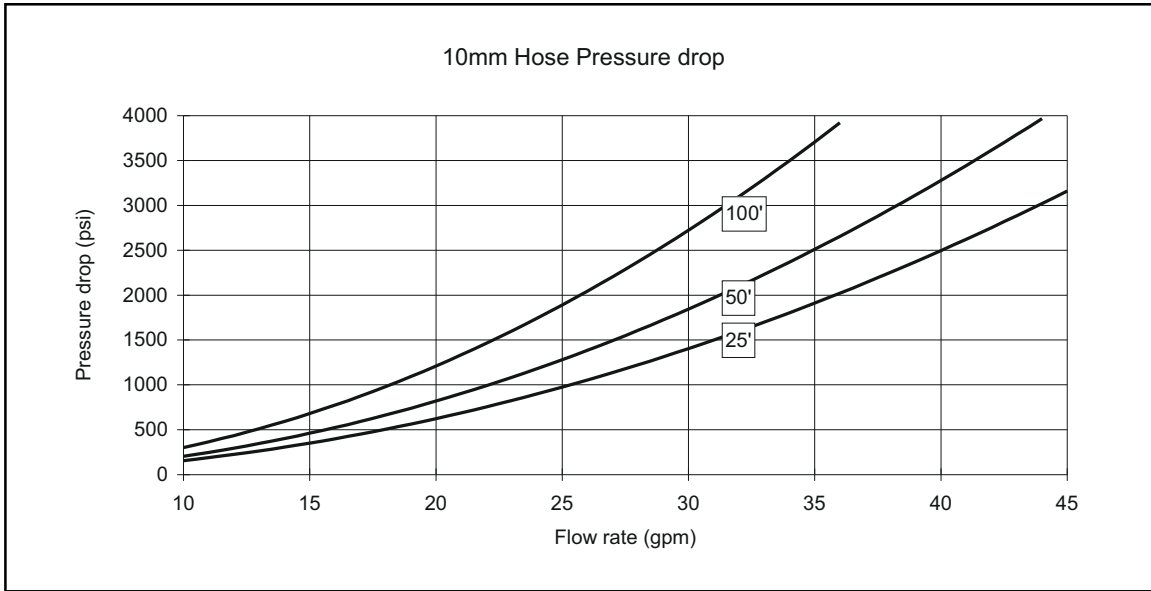

For Hose Types:

- | | |
|--------------------------------|------------------------------|
| 2245N-08V30 (2013 ST) | 2380F-08V07 |
| 2244N-08V10 (2113 ST) | 2440N-08V30 (4113 ST) |
| 2390N-08V13 (2213 ST) | 2640N-08V32 (6013 ST) |
| 2X90N-08V14 (Red Snake) | 2840D-08V30 (8013 ST) |

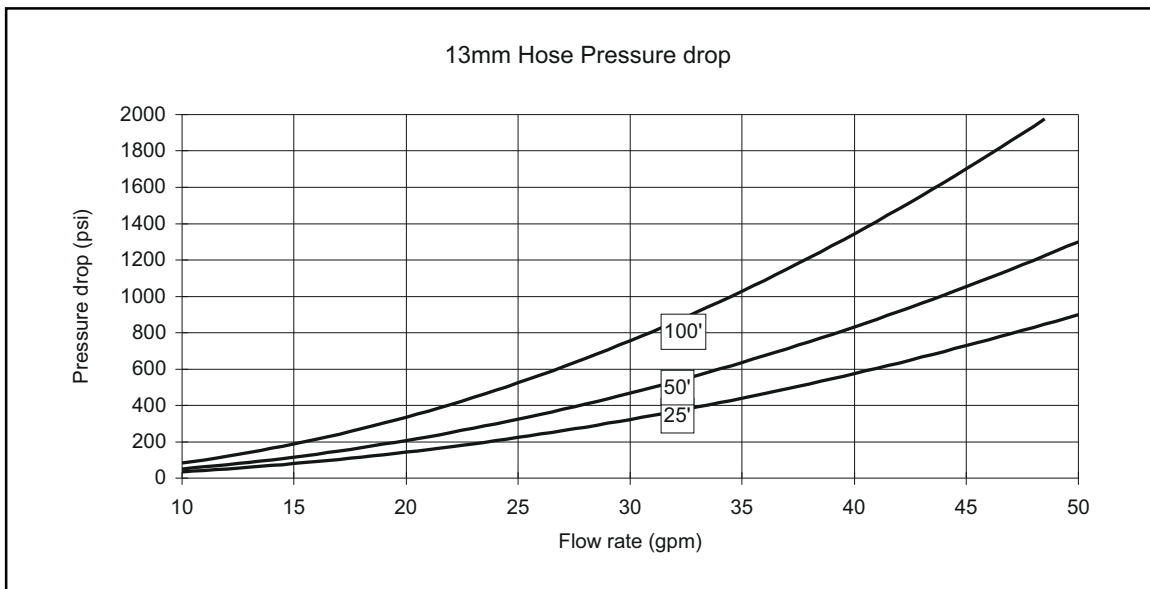

Results obtained from actual pressure drop tests, pumping water through hose assemblies with normal end fittings.

For Hose Types:

- | | |
|------------------------------|--------------------------------|
| 2380F-12V07 (FEP) | 2245N-12V30 (2025 ST) |
| 2390N-12V03 (2220 ST) | 2440N-12V37 (4120 ST) |
| 2640N-12V32 (6020 ST) | 2X90N-12V34 (Red Snake) |

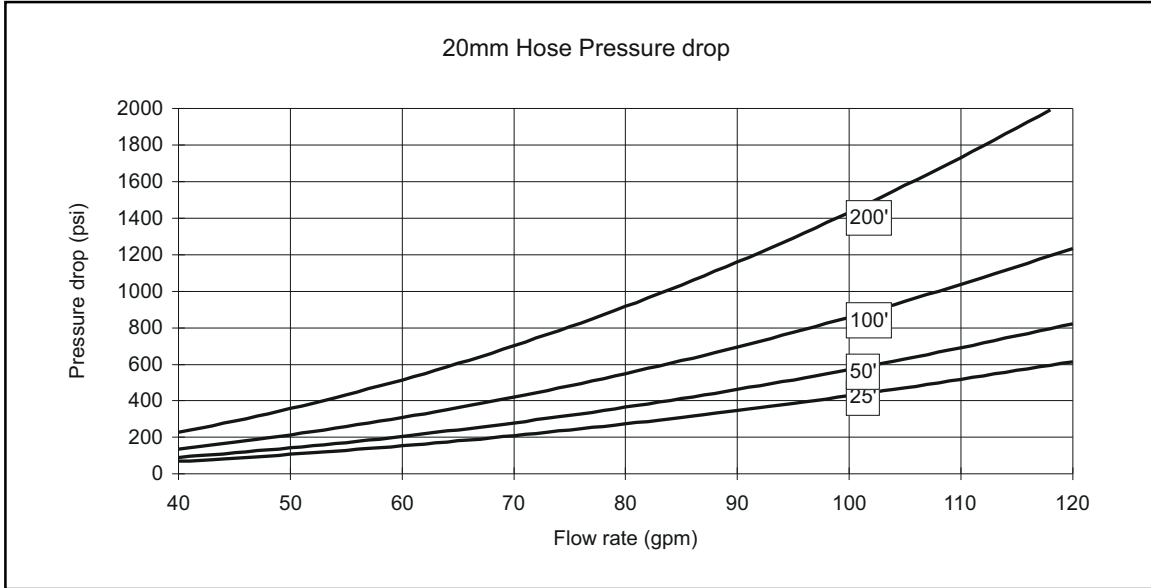

For Hose Types:

- | |
|------------------------------|
| 2245N-16V30 (2025 ST) |
| 2390N-16V13 (2225 ST) |
| 2440N-16V37 (4125ST) |

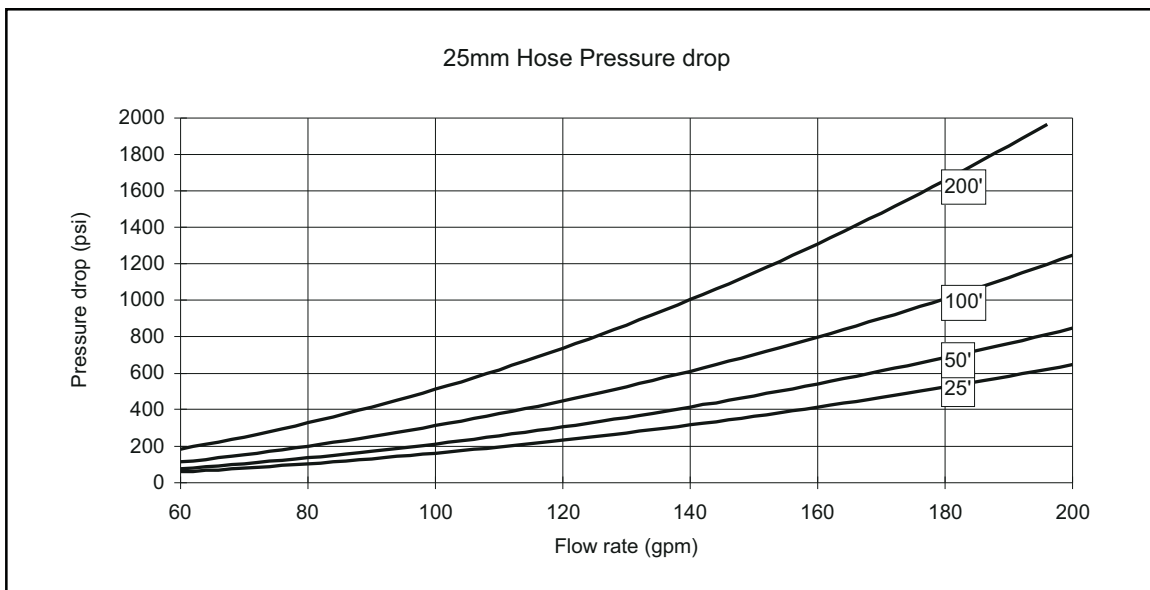

Results obtained from actual pressure drop tests, pumping water through hose assemblies with normal end fittings.

Agency and Specifications	Approved <i>polyflex</i> Products
Hydraulic Service: SAE 100R10	2244N/2380N
DIN (Deutsches Institut Für Normung): DIN 20022 Part 1 (Performance Requirements) DIN 20022 Part 2	2040N 2040H, 2245N/2244N
Electrical Non-Conductivity: SAE J517, Pitman E-00094	HP8
DNV: Cert. No. P-8934, P-8936, P-10271, P-10410 Cert. No. P-9785	HP, HP8 2040N, 2380N



Abrasion

Abrasion occurs in numerous forms; two of the more common are the typical rubbing or chafing, with the second being very high frequency, low amplitude friction. This type of abrasion results from pump pressure pulses otherwise known as pump ripple. It can also be caused by equipment vibration or resonance. Abrasion may occur when two hose lines cross or when a hose line rubs or bears against a fixed point. Abrasion resistance is also a function of temperature and attack of the cover material by aggressive chemicals.

Spring guards or other protective sleeving can also ward off premature hose failure resulting from abrasion. Spring guards also distribute bending force often associated with excessive side loading or even kinking at the skirt of the coupling.

Ambient Temperature

Exceedingly high or low ambient temperatures will affect the materials from which the hose is constructed and will negatively influence hose life. When at all possible, the hose should be routed in such a manner as to protect it from heat sources. In extreme cold applications, the equipment should be designed with remote relief valves to allow circulation and warming of the oil before hose articulation is attempted. The hose liner (core tube) of choice for extremely high or low temperature is Teflon®. Teflon® is serviceable at temperatures as low as -100°F and as high as +450°. Consult the specific hose operating parameters for more information.

Bend Radius

The minimum bend radii listed in this catalog are valid at rated working pressures and indicated service temperatures. Service life of a hose may be shortened if the minimum radius is exceeded or if the hose is flexed continuously in use.

Burst Pressure and Working Pressure

The specified burst pressure for each hose style and dash size are for unaged hoses tested at normal laboratory temperature in accordance with SAE J343 specification for normal service and technically ideal installations. The maximum recommended working pressure is 1/4 of the minimum rated burst pressure, except as otherwise specifically stated in those product specifications. For more severe service, a higher rated working pressure hose may have to be selected.

Hose Installation Tips

Establish hose size (I. D.) and style based upon flow rate (GPM), pressure drop, and chemical compatibility with fluid medium. Other significant factors to be considered in hose selection and installation are discussed briefly as follows:

Operating Temperature

The temperature range for satisfactory service (maximum hose life) depends to a great extent upon the fluid being conveyed. Use of a hose above maximum specified temperature ratings will shorten hose life due, but not limited, to oxidation, chemical degradation and loss of compression within the coupling.

Pressure Effects

Pressure surges and system shocks (spikes) are common in hydraulic systems. The normal 4:1 safety factor should reflect these transient pressures. Where these surges and shocks are considered severe or hazardous, the safety factor should be increased.

When hose is under pressure, it may change in length by as much as $\pm 3\%$. Installation should compensate for shortening by providing an appropriate amount of slack and for lengthening by allowing space for this growth to be absorbed.

Routing and Clamping

Whenever possible, and maximum efforts should be made to do so, hose should be routed to flex in a single plane. Routing hoses in flexure through compound bends results in torsions. When this is unavoidable, the torsion should be distributed over the maximum hose length possible. Wire reinforced hoses suffer the most rapid and severe loss of service life when applied in torsion. Extremely tight and improperly located clamps focus this torsion over short distances.

Analysis of the hose function is required before the proper clamping techniques can be selected. In some applications, hoses must be contained to stay out of harm's way and at the same time be free to come and go with equipment articulation. Other applications may require restrictive clamping, in which case a protective material should be used around the hose to provide the grasp without deformation of the hose by the clamp. These techniques also apply to the use of the popular method of clamping and clustering hoses with plastic tie straps.

Parker swivel adaptors feature 360° swiveling action that especially suits them for use in applications where hose moves, bends or twists. Swivel adaptors connected to hose assemblies relieve twisting, prevent excessive flexing of hose, eliminate need for long radius bends, and cushion intraline shock caused by peak system pressure pulses.

High Pressure Adapters

It is critical that the adapter material be properly suited to the fluid media. Widely varying conditions frequently necessitate high pressure adapters constructed of materials other than conventional 316 stainless steel. Since many variables affect the corrosion resistance of metallic materials, it is Parker Hannifin's policy not to recommend materials based on corrosion resistance for specific fluid applications. The published recommended working pressure represent the capability of the subject fitting. Nevertheless, in some instances, the hose, hose fitting or other connector assembled to the adapter may dictate the maximum working pressure. The end-user should read and understand the Parker Safety Guide (Bulletin 4400-B.1) and follow its suggested practices and warnings.

$$\text{Permeability Coefficient} = \frac{V}{A \times T \times p}$$

- Where: V is the volume of gas, in cm³, which diffuses through a 1mm thickness.
 A is the area across which the gas diffuses, in m².
 T is the diffusion time, in days.
 p is the pressure difference across the plastic, in bar.

Permeability Coefficients per DIN 53380

Material	Gas				
	N ₂	O ₂	CO ₂	H ₂	He
PTFE	50	150	1500	—	3500
PVDF	3	2	10	—	60
PA-6 XE 3289	1	4	10	100*	60*
PA-6 A 28 NZ	0.5	2	5	50*	30*
PA-12 L 2124	—	30	180	210	160
PA-12 P40 TL	—	—	105	—	—
PA-12 L 25W40	8	35	150	1000*	500*
PA-12 L 2140	—	12	71	—	130
PA-11 P 40 TL	—	—	55	130	—
PA-11 POTL	2	20	65	65	—
POM H 2320	5	10	130	35	40
POM 150 SA	2	4	20	—	—
PEE 4055	150	—	3000	—	1400
PEE 5556	120	—	1600	—	900
PEE 7246	—	—	—	—	300

* Calculated value. Diffusion constants based on normal room temperature. Actual behavior may vary considerably because of variations in processing the plastic.

F

Connection	Thread Sizes	Tightening Torque (ft. Lb)
High Pressure		
1/4"	9/16" - 18thd	25
3/8"	3/4" - 16thd	50
9/16"	1-1/8" - 12thd	75
Medium Pressure		
1/4"	7/16" - 20thd	20
3/8"	9/16" - 18thd	30
9/16"	13/16" - 16thd	85
3/4"	3/4" NPSM	90
1"	1-3/8" - 12thd	125
Type "M" Swivel		
A9	9/16" - 18thd	25-30
A12	3/4" - 16thd	40-50
A14	7/8" - 14thd	50-60
A16	1" - 12thd	75-85
A21	1-5/16" - 12thd	100-120

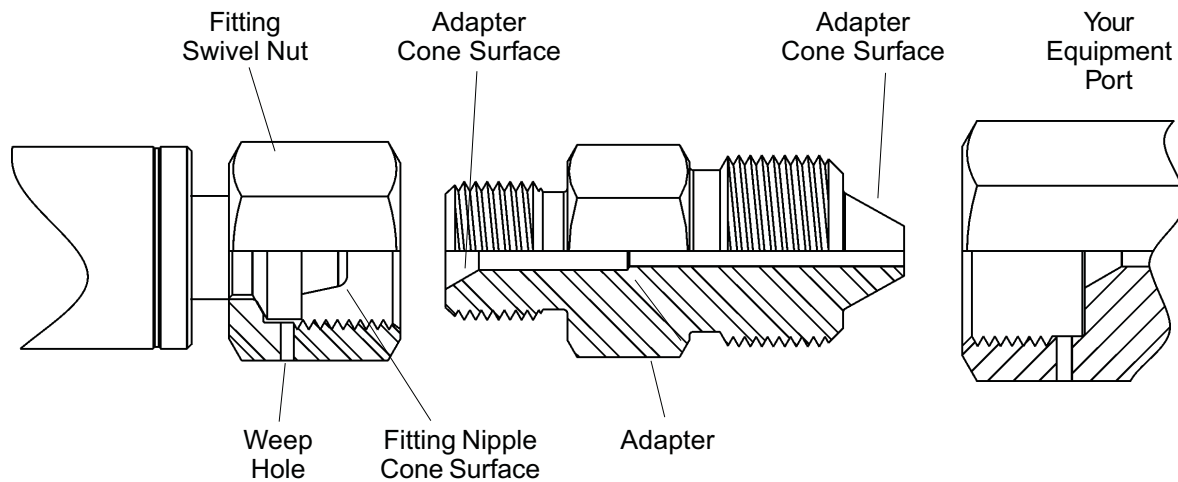

Leakage at Swivel Nut-to-Adapter Joint

(Seen by leak at weep hole in swivel nut)

1. Reduce system pressure to zero
2. Unscrew swivel nut and check cone surfaces of adapter and hose insert.
3. If hose insert is damaged, return hose to **polyflex** for repair and retest.
4. If cone surfaces look good after cleaning, re-tighten swivel nut. Do not exceed 150% of recommended torque.

Leakage at Type "M" Adapter-to-Port

(Seen by leak at weep hole in pressure port, or leak at threads for NPT adapters.)

1. Reduce system pressure to zero.
2. Slacken Hose Swivel Nut.
3. Tighten Adaptor into Port.
4. Re-tighten Swivel Nut.

Never use the swivel nut to tighten the adapter into the port.

Metric Conversion Chart

	English to Metric			Metric to English		
	To Convert From	To	Multiply	To Convert From	To	Multiply
Area	sq. in. (in ²)	sq. mm (mm ²)	645.16	sq. mm (mm ²)	sq. in. (in ²)	0.00155
	sq. in. (in ²)	sq. cm (cm ²)	6.4516			
	sq. ft. (ft ²)	sq. meters (m ²)	0.0929			
Density	pounds/cubic foot (lb/ft ³)	Kilograms/cubic meter (kg/m ³)	16.02	Kilograms/cubic meter (kg/m ³)	pounds/cubic foot (lb/ft ³)	0.0624
Energy	British Thermal Units (Btu) (1 J = Ws = 0.2388 cal)	joules (J)	1055	joules (J)	British Thermal Units (Btu)	0.000947
Force	pounds - force (lbf) (1N = 0.102 kgf)	newtons (N)	4.448	newtons (N)	pounds - force (lbf)	0.2248
Length	inches (in)	millimeters (mm)	25.4	millimeters (mm)	inches (in)	0.03937
	feet (ft)	meters (m)	0.3048	meters (m)	feet (ft)	3.281
	miles (mi)	kilometers (km)	1.609	kilometers (km)	miles (mi)	0.621
Mass (Weight)	ounces (oz.)	grams (g)	28.35	grams (g)	ounces (oz.)	0.035
	pounds - mass (lb)	kilograms (kg)	0.4536	kilograms (kg)	pounds - mass (lb)	2.205
	short tons (2000 lb) (tn)	metric tons (1000 kg)	0.9072	metric tons (1000 kg)	short tons (2000 lb) (tn)	1.102
Power	horsepower (550 ft. lb/s) (hp)	kilowatts (kW)	0.7457	kilowatts (kW)	horsepower (550 ft. lb/s) (hp)	1.341
Pressure	pounds/square inch (psi)	kilograms (f)/square cm (kg(f)/cm ²)	0.0703	kilograms (f)/square cm (kg(f)/cm ²)	pounds/square inch (psi)	14.22
	pounds/square inch (psi)	kilopascals (kPa)	6.8948	kilopascals (kPa)	pounds/square inch (psi)	0.145
	pounds/square inch (psi)	bars (100 kPa)	0.06895	bars (100 kPa)	pounds/square inch (psi)	14.503
Stress	pounds/square inch (psi) (1N/mm ² = 1MPa)	megapascals (MPa)	0.006895	megapascals (MPa)	pounds/square inch (psi)	145.039
Temperature	degrees Fahrenheit (°F)	degrees Celsius (°C)	5/9 (after subtracting 32)	degrees Celsius (°C)	degrees Fahrenheit (°F)	9/5 (then add 32)
Torque or Bending Moment	pounds-force-foot (lb-ft)	Newtons-meter (Nm)	1.3567	Newtons-meter (Nm)	pounds-force-foot (lb-ft)	0.737
	pounds-force-inch (lb-in)	Newtons-meter (Nm)	0.113	Newtons-meter (Nm)	pounds-force-inch (lb-in)	8.85
Velocity	feet/seconds (ft/s)	meters/second (m/S)	0.3048	meters/second (m/S)	feet/seconds (ft/s)	3.2808
Viscosity	dynamic (centipoise)	Pascal-second (Pas)	0.001	Pascal-second (Pas)	dynamic (centipoise)	1000
	kenematic-foot ² /sec (ft ² /s)	meter ² /sec (m ² /s)	0.0929	meter ² /sec (m ² /s)	kenematic-foot ² /sec (ft ² /s)	10.7643
Volume	cubic inch (in ³)	cubic centimeter (cm ³) (milliliter)	16.3871	cubic centimeter (cm ³) (milliliter)	cubic inch (in ³)	0.061
	quarts (qt)	liters (1000 cm ³)	0.9464	liters (1000 cm ³)	quarts (qt)	1.057
	gallons (gal)	liters	3.7854	liters	gallons (gal)	0.2642

F

Ratings Code:

- G** – Good to excellent. Little or no swelling, tensile or surface changes. Preferred choice.
- L** – Marginal or conditional. Noticeable effects but not necessarily indicating lack of serviceability. Further testing suggested for specific application. Very long-term effects such as stiffening or potential for crazing should be evaluated.
- P** – Poor or unsatisfactory. Not recommended without extensive and realistic testing.
- – Indicates that this was not tested.
- #** – For Teflon. Indicates good chemical resistance but potential for excessive permeation.

Polyester Elastomer "H" Core Tube	Polyamide "N" Core Tube	Polyoxy-methylene "POM" Core Tube	Fluorinated-ethylene "F" Core Tube	Proprietary Fluoropolymer "M" Core Tube	Polyurethane "U" Hose Covers	Polyamide "N" Hose Covers
2040H	2020N	2240D	2380F	2380M	2040N	2020N
2370H	2040N	2243D		2440M	2244N	2240D
	2244N	2245D		2640M	2245N	2243D
	2245N	2440D			2380F	2245D
	2380N	2640D			2380N	2245N-8
	2390N	2740D			2390N	2245N-12
	2440N	2840D			2440N-32V10	2245N-16
	2640N				2640N-24V80	2380N-04V33
	2X90N				2640N-32V80	2440D
					2X90N	2440N
						2640D
						2640N
						2740D
						2840D

Notes on the Chemical Resistance Table

- (1) The fluid resistance tables are simplified rating tabulations based on immersion tests at 24° C. Higher temperatures tend to reduce ratings. **Since final selection depends on pressure, fluid and ambient temperature and other factors not known to Parker Hannifin, no performance guarantee is expressed or implied.** The indications do not imply any compliance with standards and regulations and do not refer to possible changes of colour, taste or smell. For food and drinking water specially approved materials have to be used. For fluids not listed or for advice on particular applications, please consult Parker Hannifin, Polyflex in Stafford, TX.
- (2) Hose applications for these fluids must take into account legal and insurance regulations. The chemical resistance indicated does not express or imply approval by certain institutions.
- (3) Satisfactory at some concentrations and temperatures, unsatisfactory at others.
- (4) For gas applications, the cover should be pin-pricked and the pressure must not be released quickly. Special safety guard accessories are to be used to prevent damage or personal injury in the event of failure..
- (5) Chemical resistance does not imply low permeation rates. Please consult Parker Hannifin for a recommendation for your specific requirements.
- (6) The indication of chemical resistance does not imply any special food compatibility; it refers only to the chemical resistance of the material.
- (7) Chemical resistance does not imply acceptability for use in airless paintspray applications. These applications require a special, electrically conductive hose.

Chemical	H	N	U	POM	FEP
Acetaldehyde	G	L	L	—	G
Acetic Acid Glacial	L	L	L	—	L
Acetone	L	G	P	L	G
Acetylene	2	2	2	—	2
Air (4)	G	G	G	G	G
Ammonium Chloride	G	P	G	—	L
Ammonium Hydroxide	L	G	P	—	G
Anhydrous Ammonia	P	P	P	—	8
Aniline	P	P	P	—	G
Animal Oils (6)	G	G	G	—	—
Aromatic Hydrocarbons	L	G	L	—	—
Asphalt	G	G	G	—	L
Baygon (insecticide)	L	G	P	—	—
Beer	G	G	G	—	G
Benzene	L	G	L	—	G
Brake Fluid (DOT #3)	—	G	P	L	—
Butane (2) (4)	G	G	L	—	#
Butter (6)	G	G	G	—	—
Calcium Chloride	G	3	G	—	G
Carbon Dioxide (4)	G	G	G	—	#
Carbon Monoxide (4)	G	3	G	—	#
Carbon Tetrachloride	L	G	P	—	G
Castor Oil	G	L	L	—	—
Chlordane (Insecticide)	L	G	P	—	—
Chlorinated Hydrocarbon Base Fluids	L	G	L	—	—
Chlorinated Petroleum Oil	G	G	L	—	—
Chlorinated Solvents	P	3	P	—	#
Chlorine, Gaseous, Dry	P	P	P	—	—
Chloroform	P	P	P	—	G
Chromic Acid	P	3	P	—	L
Citric Acid Solutions	G	G	L	—	G
Crude Petroleum Oil	G	G	G	G	—
Cyclohexane (2)	G	G	G	—	G
Cygon (Insecticide)	L	G	P	—	—
Diazion (insecticide)	L	G	P	—	—
Diesel Fuel (2)	G	G	G	G	—
Diester Oils	L	G	P	—	—
Enamels	G	G	G	—	—
Ethanol (6)	G	G	L	G	—
Ethers	L	G	P	P	G
Ethylene Glycol	G	G	L	G	G
Ethylene Oxide	G	G	L	—	#
Fatty Acids	G	G	3	—	G
Formaldehyde	L	L	P	—	G
Formic Acid J	P	P	P	—	G

F

Chemical	H	N	U	POM	FEP
Freon 12 (5)	P	G	L	—	#
Freon 22 (5)	P	G	L	—	#
Fruit Juices	G	G	G	—	—
Fuel Oil (2)	G	G	L	G	G
Gas (Oil) (2)	G	G	G	—	—
Gas (Natural) (4)	—	—	—	—	2
Gasoline (2)	G	G	3	—	G
Glue	3	3	3	—	3
Glycerin	G	G	L	—	G
Glycols (to 135°F)	G	G	L	G	G
Grease (petroleum base)	G	G	G	G	—
Heptachlor (insecticide)	L	G	P	—	—
Hexane (2)	G	G	G	—	G
Houghto Safe-600 Series (hydraulic fluid)	— G	G	L	—	—
Houghto Safe-1000 Series (phosphate esters)	— L	G	P	—	—
Hydraulic Fluid (petroleum base)	G	G	G	G	L
Hydraulic Fluid (phosphate ester base)	L	G	L	—	—
Hydraulic Fluid (water glycol base)	G	G	G	—	—
Hydraulic Oil (petroleum base)	G	G	G	G	L
Hydrochloric Acid	P	L	P	—	G
Hydrofluoric Acid	P	P	P	—	G
Hydrogen, Gaseous (2) (4) (5)	G	G	G	—	#
Hydrolube (hydraulic fluid/water glycol base)	— G	G	L	—	—
IRUS 902 (hydraulic fluid/water-oil emulsion)	— G	G	G	—	—
Isocyanates (2)	L	L	L	—	—
IsoOctane (2)	G	G	G	—	G
Isopropyl Alcohol	G	G	L	—	G
Kerosene (2)	G	G	L	—	G
Ketones	L	G	P	—	G
Lacquer Solvents	L	G	P	—	L
Lactic Acid	P	G	P	—	G
Lime (calcium oxide)	G	G	G	—	G
Lindol (hydraulic fluid\phosphate esters)	— L	G	P	—	—
Linseed Oil	G	G	G	G	G
LP - Gas	2	2	2	—	2
Lubricating Oils (diester base)	L	G	P	—	—
Lubricating Oils (petroleum base)	G	G	G	G	G
Magnesium Hydroxide	L	G	L	—	G
Magnesium Salts	—	G	G	—	—
Malathion (insecticide)	L	G	P	—	—

Chemical	H	N	U	POM	FEP
Mercury	G	G	G	—	G
Meropa Oil (sulphur base)	G	G	—	—	—
Methane	2	2	2	—	2
Methanol	G	G	P	—	—
Methoxychlor (insecticide)	L	G	P	—	—
Methyl Alcohol (6)	G	G	P	G	G
Methylene Chloride	—	—	—	—	G
Methyl Ethyl Ketone (MEK)	L	G	P	L	G
Methyl Ethyl Ketone Peroxide (MEKP)	—	L	P	—	—
Methyl Isobutyl Ketone (MIBK)	L	G	P	—	G
Methylene Chloride	P	L	P	P	
Milk (6)	G	G	G	—	G
Mineral Oil	G	G	G	G	G
Mineral Spirits	P	—	L	—	—
Motor Oils	G	G	G	—	G
Naphtha	L	G	P	G	G
Natural Gas (4)	2	2	2	—	2
Nitric Acid	P	P	P	—	L
Nitrobenzene	P	G	P	—	G
Nitrogen, Gaseous (4) (5)	G	G	G	—	G
Nitrous Oxide	—	L	—	—	#
Oil (SAE)	G	G	G	G	—
Oil of Turpentine	G	G	P	—	—
Oleic Acid	G	G	G	—	G
OS 45 Type 3 Hydraulic Fluid (silicate esters)	L	G	L	—	—
Oxygen, Gaseous (4) (5) (6)	G	G	G	—	G
Ozone	L	P	L	—	G
Paint (Oil Base) (7)	G	G	G	—	—
Paint Solvents (oil base)	L	G	L	—	—
Pentane (2)	G	G	L	—	G
Perchloric Acid	P	P	P	—	L
Perchloroethylene	P	P	P	L	—
Petroleum Ether	—	2	2	—	2
Petroleum Oils	G	G	G	—	—
Phenols	P	P	P	—	—
Phosphate Esters (above 135°F)	P	G	P	—	—
Phosphate Esters (to 135°F)	G	G	P	—	—
Polyol Esters	L	G	P	—	—
Potassium Hydroxide, 50%	P	P	P	—	G
Propane (4) (5)	2	2	2	—	2
Propylene Glycol	—	—	G	—	G
Pydraul 312C, 625 (to 135°F)	P	G	P	—	—
Pydraul F-9, 150, 160 (to 135°F)	G	G	P	—	—
Quintolubric 822 Fluid	—	G	G	—	—

F

Chemical	H	N	U	POM	FEP
Salt Water	3	3	3	—	G
Sevin (insecticides in water)	G	G	G	—	—
Silicone Greases	G	G	G	—	—
Silicone Oils	G	G	G	—	—
Skydrol 500 & 7000	L	G	P	—	G
Soap Solutions	G	G	G	—	G
Soda Water	G	G	G	—	—
Sodium Borate	G	G	G	—	G
Sodium Carbonate	3	3	3	—	3
Sodium Chloride Solutions	G	G	G	—	G
Sodium Hydroxide, 50%	L	P	P	—	G
Sodium Hypochlorite	L	P	P	—	G
Steam	P	P	P	—	G
Stoddard Solvent	P	G	P	—	G
Straight Synthetic Oils (phosphate esters)	L	G	P	—	—
Sulfur	G	G	G	—	G
Sulfur Dioxide	P	L	L	—	G
Sulfur Hexafluoride Gas (4) (5)	G	G	G	—	—
Sulphuric Acid	P	P	P	—	—
Toluol, Toluene	L	G	L	G	G
Toluol	L	G	L	—	—
Transmission Fluid	G	G	G	L	—
Trichloroethylene	P	L	P	—	G
Trisodium Phosphate Solutions	L	G	P	—	G
Turpentine	G	G	L	—	G
Ucon (hydraulic fluid-water glycol base)	G	G	L	—	—
Varnish	G	G	G	G	—
Vinegar (6)	L	G	L	—	G
Water (to 135°F) (6)	G	G	G	G	G
Water (above 135°F) (6)	P	G	P	—	L
Water Glycols (to 135°F)	G	G	L	—	—
Water Glycols (above 135°F)	P	G	P	—	—
Water in oil Emulsions (to 135°F)	G	G	L	G	—
Water in oil Emulsions (above 135°F)	P	G	P	—	—
Whiskey, Wines (6)	G	G	L	—	G
Wood Oils	G	G	L	G	—
Xylene	L	G	P	G	G
Zinc Chloride	G	G	G	—	G



Parker Safety Guide for Selecting and Using Hose, Tubing, Fittings and Related Accessories

Parker Publication No. 4400-B.1

Revised: November, 2007

WARNING: Failure or improper selection or improper use of hose, tubing, fittings, assemblies or related accessories (“Products”) can cause death, personal injury and property damage. Possible consequences of failure or improper selection or improper use of these Products include but are not limited to:

- Fittings thrown off at high speed.
- High velocity fluid discharge.
- Explosion or burning of the conveyed fluid.
- Electrocutation from high voltage electric powerlines.
- Contact with suddenly moving or falling objects that are controlled by the conveyed fluid.
- Injections by high-pressure fluid discharge.
- Dangerously whipping Hose.
- Contact with conveyed fluids that may be hot, cold, toxic or otherwise injurious.
- Sparking or explosion caused by static electricity buildup or other sources of electricity.
- Sparking or explosion while spraying paint or flammable liquids.
- Injuries resulting from inhalation, ingestion or exposure to fluids.

Before selecting or using any of these Products, it is important that you read and follow the instructions below. Only Hose from Parker’s Stratoflex Products Division is approved for in-flight aerospace applications.

1.0 **GENERAL INSTRUCTIONS**

- 1.1 **Scope:** This safety guide provides instructions for selecting and using (including assembling, installing, and maintaining) these Products. For convenience, all rubber and/or thermoplastic products commonly called “hose” or “tubing” are called “Hose” in this safety guide. All assemblies made with Hose are called “Hose Assemblies”. All products commonly called “fittings”, “couplings” or “adapters” are called “Fittings”. All related accessories (including crimping and swaging machines and tooling) are called “Related Accessories”. This safety guide is a supplement to and is to be used with the specific Parker publications for the specific Hose, Fittings and Related Accessories that are being considered for use. Parker publications are available at www.parker.com. SAE J1273 (www.sae.org) and ISO 17165-2 (www.ansi.org) also provide recommended practices for hydraulic Hose Assemblies.
- 1.2 **Fail-Safe:** Hose, Hose Assemblies and Fittings can and do fail without warning for many reasons. Design all systems and equipment in a fail-safe mode, so that failure of the Hose, Hose Assembly or Fitting will not endanger persons or property.
- 1.3 **Distribution:** Provide a copy of this safety guide to each person responsible for selecting or using Hose and Fitting products. Do not select or use Parker Hose or Fittings without thoroughly reading and understanding this safety guide as well as the specific Parker publications for the Products.
- 1.4 **User Responsibility:** Due to the wide variety of operating conditions and applications for Hose and Fittings, Parker does not represent or warrant that any particular Hose or Fitting is suitable for any specific end use system. This safety guide does not analyze all technical parameters that must be considered in selecting a product. The user, through its own analysis and testing, is solely responsible for:
- Making the final selection of the Products.
 - Assuring that the user’s requirements are met and that the application presents no health or safety hazards.
 - Providing all appropriate health and safety warnings on the equipment on which the Products are used.
 - Assuring compliance with all applicable government and industry standards.
- 1.5 **Additional Questions:** Call the appropriate Parker technical service department if you have any questions or require any additional information. See the Parker publication for the Products being considered or used, or call 1-800-CPARKER, or go to www.parker.com, for telephone numbers of the appropriate technical service department.

2.0 **HOSE AND FITTINGS SELECTION INSTRUCTIONS**

- 2.1 **Electrical Conductivity:** Certain applications require that the Hose be nonconductive to prevent electrical current flow. Other applications require the Hose and the Fittings and the Hose/Fitting interface to be sufficiently conductive to drain off static electricity. Extreme care must be exercised when selecting Hose and Fittings for these or any other applications in which electrical conductivity or nonconductivity is a factor.
- The electrical conductivity or nonconductivity of Hose and Fittings is dependent upon many factors and may be susceptible to change. These factors include but are not limited to the various materials used to make the Hose and the Fittings, Fitting finish (some Fitting finishes are electrically conductive while others are nonconductive), manufacturing methods (including moisture control), how the Fittings contact the Hose, age and amount of deterioration or damage or other changes, moisture content of the Hose at any particular time, and other factors.
- The following are considerations for electrically nonconductive and conductive Hose. For other applications consult the individual catalog pages and the appropriate industry or regulatory standards for proper selection.
- 2.1.1 **Electrically Nonconductive Hose:** Certain applications require that the Hose be nonconductive to prevent electrical current flow or to maintain electrical isolation. For applications that require Hose to be electrically nonconductive, including but not limited to applications near high voltage electric lines, only special nonconductive Hose can be used. The manufacturer of the equipment in which the nonconductive Hose is to be used must be consulted to be certain that the Hose and Fittings that are selected are proper for the application. Do not use any Parker Hose or Fittings for any such application requiring nonconductive Hose, including but not limited to applications near high voltage electric lines, unless (i) the application is expressly approved in the Parker technical publication for the product, (ii) the Hose is marked “nonconductive”, and (iii) the manufacturer of the equipment on which the Hose is to be used specifically approves the particular Parker Hose and Fittings for such use.

- 2.1.2 Electrically Conductive Hose:** Parker manufactures special Hose for certain applications that require electrically conductive Hose. Parker manufactures special Hose for conveying paint in airless paint spraying applications. This Hose is labeled “Electrically Conductive Airless Paint Spray Hose” on its layline and packaging. This Hose must be properly connected to the appropriate Parker Fittings and properly grounded in order to dissipate dangerous static charge buildup, which occurs in all airless paint spraying applications. Do not use any other Hose for airless paint spraying, even if electrically conductive. Use of any other Hose or failure to properly connect the Hose can cause a fire or an explosion resulting in death, personal injury, and property damage.
- Parker manufactures a special Hose for certain compressed natural gas (“CNG”) applications where static electricity buildup may occur. Parker CNG Hose assemblies comply with the requirements of ANSI/IAS NGV 4.2-1999; CSA 12.52-M99, “Hoses for Natural Gas Vehicles and Dispensing Systems” (www.ansi.org). This Hose is labeled “Electrically Conductive for CNG Use” on its layline and packaging. This Hose must be properly connected to the appropriate Parker Fittings and properly grounded in order to dissipate dangerous static charge buildup, which occurs in, for example, high velocity CNG dispensing or transfer. Do not use any other Hose for CNG applications where static charge buildup may occur, even if electrically conductive. Use of other Hoses in CNG applications or failure to properly connect or ground this Hose can cause a fire or an explosion resulting in death, personal injury, and property damage. Care must also be taken to protect against CNG permeation through the Hose wall. See section 2.6, Permeation, for more information. Parker CNG Hose is intended for dispenser and vehicle use at a maximum temperature of 180°F (82°C). Parker CNG Hose should not be used in confined spaces or unventilated areas or areas exceeding 180°F (82°C). Final assemblies must be tested for leaks. CNG Hose Assemblies should be tested on a monthly basis for conductivity per ANSI/IAS NGV 4.2-1999; CSA 12.52-M99.
- Parker manufactures special Hose for aerospace in-flight applications. Aerospace in-flight applications employing Hose to transmit fuel, lubricating fluids and hydraulic fluids require a special Hose with a conductive inner tube. This Hose for in-flight applications is available only from Parker’s Stratoflex Products Division. Do not use any other Parker Hose for in-flight applications, even if electrically conductive. Use of other Hoses for in-flight applications or failure to properly connect or ground this Hose can cause a fire or an explosion resulting in death, personal injury and property damage. These Hose assemblies for in-flight applications must meet all applicable aerospace industry, aircraft engine and aircraft requirements.
- 2.2 Pressure:** Hose selection must be made so that the published maximum working pressure of the Hose and Fittings are equal to or greater than the maximum system pressure. The maximum working pressure of a Hose Assembly is the lower of the respective published maximum working pressures of the Hose and the Fittings used. Surge pressures or peak transient pressures in the system must be below the published maximum working pressure for the Hose. Surge pressures and peak pressures can usually only be determined by sensitive electrical instrumentation that measures and indicates pressures at millisecond intervals. Mechanical pressure gauges indicate only average pressures and cannot be used to determine surge pressures or peak transient pressures. Published burst pressure ratings for Hose is for manufacturing test purposes only and is no indication that the Product can be used in applications at the burst pressure or otherwise above the published maximum recommended working pressure.
- 2.3 Suction:** Hoses used for suction applications must be selected to insure that the Hose will withstand the vacuum and pressure of the system. Improperly selected Hose may collapse in suction application.
- 2.4 Temperature:** Be certain that fluid and ambient temperatures, both steady and transient, do not exceed the limitations of the Hose. Temperatures below and above the recommended limit can degrade Hose to a point where a failure may occur and release fluid. Properly insulate and protect the Hose Assembly when routing near hot objects (e.g. manifolds). Do not use any Hose in any application where failure of the Hose could result in the conveyed fluids (or vapors or mist from the conveyed fluids) contacting any open flame, molten metal, or other potential fire ignition source that could cause burning or explosion of the conveyed fluids or vapors.
- 2.5 Fluid Compatibility:** Hose Assembly selection must assure compatibility of the Hose tube, cover, reinforcement, and Fittings with the fluid media used. See the fluid compatibility chart in the Parker publication for the product being considered or used. This information is offered only as a guide. Actual service life can only be determined by the end user by testing under all extreme conditions and other analysis. Hose that is chemically compatible with a particular fluid must be assembled using Fittings and adapters containing likewise compatible seals.
- 2.6 Permeation:** Permeation (that is, seepage through the Hose) will occur from inside the Hose to outside when Hose is used with gases, liquid and gas fuels, and refrigerants (including but not limited to such materials as helium, diesel fuel, gasoline, natural gas, or LPG). This permeation may result in high concentrations of vapors which are potentially flammable, explosive, or toxic, and in loss of fluid. Dangerous explosions, fires, and other hazards can result when using the wrong Hose for such applications. The system designer must take into account the fact that this permeation will take place and must not use Hose if this permeation could be hazardous. The system designer must take into account all legal, government, insurance, or any other special regulations which govern the use of fuels and refrigerants. Never use a Hose even though the fluid compatibility is acceptable without considering the potential hazardous effects that can result from permeation through the Hose Assembly.
- Permeation of moisture from outside the Hose to inside the Hose will also occur in Hose assemblies, regardless of internal pressure. If this moisture permeation would have detrimental effects (particularly, but not limited to refrigeration and air conditioning systems), incorporation of sufficient drying capacity in the system or other appropriate system safeguards should be selected and used.
- 2.7 Size:** Transmission of power by means of pressurized fluid varies with pressure and rate of flow. The size of the components must be adequate to keep pressure losses to a minimum and avoid damage due to heat generation or excessive fluid velocity.
- 2.8 Routing:** Attention must be given to optimum routing to minimize inherent problems (kinking or flow restriction due to Hose collapse, twisting of the Hose, proximity to hot objects or heat sources). For additional routing recommendations see SAE J1273 and ISO 17165-2. Hose Assemblies have a finite life and if possible, should be installed in a manner that allows for ease of inspection and future replacement. Rubber Hose because of its relative short life, should not be used in residential and commercial buildings for HVAC (heating, ventilating and air conditioning) applications.
- 2.9 Environment:** Care must be taken to insure that the Hose and Fittings are either compatible with or protected from the environment (that is, surrounding conditions) to which they are exposed. Environmental conditions including but not limited to ultraviolet radiation, sunlight, heat, ozone, moisture, water, salt water, chemicals and air pollutants can cause degradation and premature failure.
- 2.10 Mechanical Loads:** External forces can significantly reduce Hose life or cause failure. Mechanical loads which must be considered include excessive flexing, twist, kinking, tensile or side loads, bend radius, and vibration. Use of swivel type Fittings or adapters may be required to insure no twist is put into the Hose. Unusual applications may require special testing prior to Hose selection.
- 2.11 Physical Damage:** Care must be taken to protect Hose from wear, snagging, kinking, bending smaller than minimum bend radius and cutting, any of which can cause premature Hose failure. Any Hose that has been kinked or bent to a radius smaller than the minimum bend radius, and any Hose that has been cut or is cracked or is otherwise damaged should be removed and discarded.
- 2.12 Proper End Fitting:** See instructions 3.2 through 3.5. These recommendations may be substantiated by testing to industry standards such as SAE J517 for hydraulic applications, or MIL-A-5070, AS1339, or AS3517 for Hoses from Parker’s Stratoflex Products Division for aerospace applications.
- 2.13 Length:** When establishing a proper Hose length, motion absorption, Hose length changes due to pressure, and Hose and machine tolerances and movement must be considered.

- 2.14 **Specifications and Standards:** When selecting Hose and Fittings, government, industry, and Parker specifications and recommendations must be reviewed and followed as applicable.
- 2.15 **Hose Cleanliness:** Hose components may vary in cleanliness levels. Care must be taken to insure that the Hose Assembly selected has an adequate level of cleanliness for the application.
- 2.16 **Fire Resistant Fluids:** Some fire resistant fluids that are to be conveyed by Hose require use of the same type of Hose as used with petroleum base fluids. Some such fluids require a special Hose, while a few fluids will not work with any Hose at all. See instructions 2.5 and 1.5. The wrong Hose may fail after a very short service. In addition, all liquids but pure water may burn fiercely under certain conditions, and even pure water leakage may be hazardous.
- 2.17 **Radiant Heat:** Hose can be heated to destruction without contact by such nearby items as hot manifolds or molten metal. The same heat source may then initiate a fire. This can occur despite the presence of cool air around the Hose.
- 2.18 **Welding or Brazing:** When using a torch or arc welder in close proximity to hydraulic lines, the hydraulic lines should be removed or shielded with appropriate fire resistant materials. Flame or weld spatter could burn through the Hose and possibly ignite escaping fluid resulting in a catastrophic failure. Heating of plated parts, including Hose Fittings and adapters, above 450°F (232°C) such as during welding, brazing or soldering may emit deadly gases.
- 2.19 **Atomic Radiation:** Atomic radiation affects all materials used in Hose assemblies. Since the long-term effects may be unknown, do not expose Hose assemblies to atomic radiation.
- 2.20 **Aerospace Applications:** The only Hose and Fittings that may be used for in-flight aerospace applications are those available from Parker's Stratoflex Products Division. Do not use any other Hose or Fittings for in-flight applications. Do not use any Hose or Fittings from Parker's Stratoflex Products Division with any other Hose or Fittings, unless expressly approved in writing by the engineering manager or chief engineer of Stratoflex Products Division and verified by the user's own testing and inspection to aerospace industry standards.
- 2.21 **Unlocking Couplings:** Ball locking couplings or other Fittings with quick disconnect ability can unintentionally disconnect if they are dragged over obstructions, or if the sleeve or other disconnect member, is bumped or moved enough to cause disconnect. Threaded Fittings should be considered where there is a potential for accidental uncoupling.

3.0 **HOSE AND FITTINGS ASSEMBLY AND INSTALLATION INSTRUCTIONS**

- 3.1 **Component Inspection:** Prior to assembly, a careful examination of the Hose and Fittings must be performed. All components must be checked for correct style, size, catalog number, and length. The Hose must be examined for cleanliness, obstructions, blisters, cover looseness, kinks, cracks, cuts or any other visible defects. Inspect the Fitting and sealing surfaces for burrs, nicks, corrosion or other imperfections. Do NOT use any component that displays any signs of nonconformance.
- 3.2 **Hose and Fitting Assembly:** Do not assemble a Parker Fitting on a Parker Hose that is not specifically listed by Parker for that Fitting, unless authorized in writing by the engineering manager or chief engineer of the appropriate Parker division. Do not assemble a Parker Fitting on another manufacturer's Hose or a Parker Hose on another manufacturer's Fitting unless (i) the engineering manager or chief engineer of the appropriate Parker division approves the Assembly in writing or that combination is expressly approved in the appropriate Parker literature for the specific Parker product, and (ii) the user verifies the Assembly and the application through analysis and testing. For Parker Hose that does not specify a Parker Fitting, the user is solely responsible for the selection of the proper Fitting and Hose Assembly procedures. See instruction 1.4.
To prevent the possibility of problems such as leakage at the Fitting or system contamination, it is important to completely remove all debris from the cutting operation before installation of the Fittings. The Parker published instructions must be followed for assembling the Fittings on the Hose. These instructions are provided in the Parker Fitting catalog for the specific Parker Fitting being used, or by calling 1-800-CPARKER, or at www.parker.com.
- 3.3 **Related Accessories:** Do not crimp or swage any Parker Hose or Fitting with anything but the listed swage or crimp machine and dies in accordance with Parker published instructions. Do not crimp or swage another manufacturer's Fitting with a Parker crimp or swage die unless authorized in writing by the engineering manager or chief engineer of the appropriate Parker division.
- 3.4 **Parts:** Do not use any Parker Fitting part (including but not limited to socket, shell, nipple, or insert) except with the correct Parker mating parts, in accordance with Parker published instructions, unless authorized in writing by the engineering manager or chief engineer of the appropriate Parker division.
- 3.5 **Field Attachable/Permanent:** Do not reuse any field attachable Hose Fitting that has blown or pulled off a Hose. Do not reuse a Parker permanent Hose Fitting (crimped or swaged) or any part thereof. Complete Hose Assemblies may only be reused after proper inspection under section 4.0. Do not assemble Fittings to any previously used hydraulic Hose that was in service, for use in a fluid power application.
- 3.6 **Pre-Installation Inspection:** Prior to installation, a careful examination of the Hose Assembly must be performed. Inspect the Hose Assembly for any damage or defects. DO NOT use any Hose Assembly that displays any signs of nonconformance.
- 3.7 **Minimum Bend Radius:** Installation of a Hose at less than the minimum listed bend radius may significantly reduce the Hose life. Particular attention must be given to preclude sharp bending at the Hose to Fitting juncture. Any bending during installation at less than the minimum bend radius must be avoided. If any Hose is kinked during installation, the Hose must be discarded.
- 3.8 **Twist Angle and Orientation:** Hose Assembly installation must be such that relative motion of machine components does not produce twisting.
- 3.9 **Securement:** In many applications, it may be necessary to restrain, protect, or guide the Hose to protect it from damage by unnecessary flexing, pressure surges, and contact with other mechanical components. Care must be taken to insure such restraints do not introduce additional stress or wear points.
- 3.10 **Proper Connection of Ports:** Proper physical installation of the Hose Assembly requires a correctly installed port connection insuring that no twist or torque is transferred to the Hose when the Fittings are being tightened or otherwise during use.
- 3.11 **External Damage:** Proper installation is not complete without insuring that tensile loads, side loads, kinking, flattening, potential abrasion, thread damage or damage to sealing surfaces are corrected or eliminated. See instruction 2.10.
- 3.12 **System Checkout:** All air entrapment must be eliminated and the system pressurized to the maximum system pressure (at or below the Hose maximum working pressure) and checked for proper function and freedom from leaks. Personnel must stay out of potential hazardous areas while testing and using.
- 3.13 **Routing:** The Hose Assembly should be routed in such a manner so if a failure does occur, the escaping media will not cause personal injury or property damage. In addition, if fluid media comes in contact with hot surfaces, open flame or sparks, a fire or explosion may occur. See section 2.4.
- 3.14 **Ground Fault Equipment Protection Devices (GFEPDs): WARNING! Fire and Shock Hazard.** To minimize the danger of fire if the heating cable of a Multitube bundle is damaged or improperly installed, use a Ground Fault Equipment Protection Device. Electrical fault currents may be insufficient to trip a conventional circuit breaker.
For ground fault protection, the IEEE 515:1989 (www.ansi.org) standard for heating cables recommends the use of GFEPDs with a nominal 30 milliampere trip level for "piping systems in classified areas, those areas requiring a high degree of maintenance, or which may be exposed to physical abuse or corrosive atmospheres".

4.0 **HOSE AND FITTING MAINTENANCE AND REPLACEMENT INSTRUCTIONS**

4.1 Even with proper selection and installation, Hose life may be significantly reduced without a continuing maintenance program. The severity of the application, risk potential from a possible Hose failure, and experience with any Hose failures in the application or in similar applications should determine the frequency of the inspection and the replacement for the Products so that Products are replaced before any failure occurs. A maintenance program must be established and followed by the user and, at minimum, must include instructions 4.2 through 4.7.

4.2 **Visual Inspection Hose/Fitting:** Any of the following conditions require immediate shut down and replacement of the Hose Assembly:

- Fitting slippage on Hose;
- Damaged, cracked, cut or abraded cover (any reinforcement exposed);
- Hard, stiff, heat cracked, or charred Hose;
- Cracked, damaged, or badly corroded Fittings;
- Leaks at Fitting or in Hose;
- Kinked, crushed, flattened or twisted Hose; and
- Blistered, soft, degraded, or loose cover.

4.3 **Visual Inspection All Other:** The following items must be tightened, repaired, corrected or replaced as required:

- Leaking port conditions;
- Excess dirt buildup;
- Worn clamps, guards or shields; and
- System fluid level, fluid type, and any air entrapment.

4.4 **Functional Test:** Operate the system at maximum operating pressure and check for possible malfunctions and leaks. Personnel must avoid potential hazardous areas while testing and using the system. See section 2.2.

4.5 **Replacement Intervals:** Hose assemblies and elastomeric seals used on Hose Fittings and adapters will eventually age, harden, wear and deteriorate under thermal cycling and compression set. Hose Assemblies and elastomeric seals should be inspected and replaced at specific replacement intervals, based on previous service life, government or industry recommendations, or when failures could result in unacceptable downtime, damage, or injury risk. See section 1.2. Hose and Fittings may be subjected to internal mechanical and/or chemical wear from the conveying fluid and may fail without warning. The user must determine the product life under such circumstances by testing. Also see section 2.5.

4.6 **Hose Inspection and Failure:** Hydraulic power is accomplished by utilizing high pressure fluids to transfer energy and do work. Hoses, Fittings and Hose Assemblies all contribute to this by transmitting fluids at high pressures. Fluids under pressure can be dangerous and potentially lethal and, therefore, extreme caution must be exercised when working with fluids under pressure and handling the Hoses transporting the fluids. From time to time, Hose Assemblies will fail if they are not replaced at proper time intervals. Usually these failures are the result of some form of misapplication, abuse, wear or failure to perform proper maintenance. When Hoses fail, generally the high pressure fluids inside escape in a stream which may or may not be visible to the user. Under no circumstances should the user attempt to locate the leak by "feeling" with their hands or any other part of their body. High pressure fluids can and will penetrate the skin and cause severe tissue damage and possibly loss of limb. Even seemingly minor hydraulic fluid injection injuries must be treated immediately by a physician with knowledge of the tissue damaging properties of hydraulic fluid.

If a Hose failure occurs, immediately shut down the equipment and leave the area until pressure has been completely released from the Hose Assembly. Simply shutting down the hydraulic pump may or may not eliminate the pressure in the Hose Assembly. Many times check valves, etc., are employed in a system and can cause pressure to remain in a Hose Assembly even when pumps or equipment are not operating. Tiny holes in the Hose, commonly known as pinholes, can eject small, dangerously powerful but hard to see streams of hydraulic fluid. It may take several minutes or even hours for the pressure to be relieved so that the Hose Assembly may be examined safely.

Once the pressure has been reduced to zero, the Hose Assembly may be taken off the equipment and examined. It must always be replaced if a failure has occurred. Never attempt to patch or repair a Hose Assembly that has failed. Consult the nearest Parker distributor or the appropriate Parker division for Hose Assembly replacement information.

Never touch or examine a failed Hose Assembly unless it is obvious that the Hose no longer contains fluid under pressure. The high pressure fluid is extremely dangerous and can cause serious and potentially fatal injury.

4.7 **Elastomeric seals:** Elastomeric seals will eventually age, harden, wear and deteriorate under thermal cycling and compression set. Elastomeric seals should be inspected and replaced.

4.8 **Refrigerant gases:** Special care should be taken when working with refrigeration systems. Sudden escape of refrigerant gases can cause blindness if the escaping gases contact the eye and can cause freezing or other severe injuries if it contacts any other portion of the body.

4.9 **Compressed natural gas (CNG):** Parker CNG Hose Assemblies should be tested after installation and before use, and at least on a monthly basis per ANSI/IAS NGV 4.2-1999; CSA 12.52-M99 Section 4.2 "Visual Inspection Hose/Fitting". The recommended procedure is to pressurize the Hose and check for leaks and to visually inspect the Hose for damage.

Caution: Matches, candles, open flame or other sources of ignition shall not be used for Hose inspection. Leak check solutions should be rinsed off after use.

5.0 **HOSE STORAGE**

5.1 **Age Control:** Hose and Hose Assemblies must be stored in a manner that facilitates age control and first-in and first-out usage based on manufacturing date of the Hose and Hose Assemblies. The shelf life of rubber Hose or Hose Assemblies that have passed visual inspection and a proof test is 10 years (40 quarters) from the date of manufacture. The shelf life of thermoplastic and polytetrafluoroethylene Hose or Hose Assemblies is considered to be unlimited.

5.2 **Storage:** Stored Hose and Hose Assemblies must not be subjected to damage that could reduce their expected service life and must be placed in a cool, dark and dry area with the ends capped. Stored Hose and Hose Assemblies must not be exposed to temperature extremes, ozone, oils, corrosive liquids or fumes, solvents, high humidity, rodents, insects, ultraviolet light, electromagnetic fields or radioactive materials.

Alphanumeric Index

Part Number	Page	Part Number	Page	Part Number	Page	Part Number	Page
015301 – 02Y6-16-9C							
015301	E5	101HP-2-3	B120	15K0101-8-8C	C29	2243D-03V70	B20
015306	E5	101HP-2-4	B120	15K0201-1-8C	C29	2243D-04V70	B23
015307	E5	101HP-4-3	B120	15K0201-2-8C	C29	2244N-025V00	B26
015308	E5	101HP-4-4	B120	15K0201-4-8C	C29	2244N-08V10	B28
015309	E5	101HP-4-6	B120	15K0201-6-8C	C29	2244N-08V71	B28
015736	E5	101HP-6-3	B120	15K0202-2-2C	C27	2244N-20V30	B30
02Y5-2-4C	C12	101HP-6-4	B120	15K0202-4-4C	C27	2245D-03V32	B31
02Y5-2-6C	C12	101HP-6-6	B120	15K0202-6-6C	C27	2245N-04V00	B33, B122
02Y5-2-9C	C12	101HP-8-6	B120	15K0202-8-8C	C27	2245N-04V02	B33, B122
02Y5-2-12C	C12	101NX-4-4	B15, B23, B33	15KL02-4C	C27	2245N-04V04	B33, B122
02Y5-2-16C	C12		B55, B122	15KL02-6C	C27	2245N-05V00	B37
02Y5-4-4C	C12	101NX-6-05	B37	15KL02-8C	C27	2245N-06V30	B39
02Y5-4-6C	C12	101NX-6-06	B39	15KT02-4C	C28	2245N-08V30	B41
02Y5-4-9C	C12	101NX-6-4	B15, B23, B33	15KT02-6C	C28	2245N-12V30	B43
02Y5-4-12C	C12		B55, B122	15KT02-8C	C28	2245N-16V30	B45
02Y5-4-16C	C12	101NX-6-5	B47	15KX02-4C	C28	2380F-05V07	B47
02Y5-6-4C	C12	101NX-8-06	B39	15KX02-6C	C28	2380F-08V07	B48
02Y5-6-6C	C12	101PX-4-4	B6	15KX02-8C	C28	2380F-12V07	B50
02Y5-6-9C	C12	101RS-8-08	B115	1925X-4-3	B94	2380N-04V00	B52, B125
02Y5-6-12C	C12	1068X-4-4	B53, B112, B126	1928X-4-4	B53, B61	2380N-04V02	B52, B125
02Y5-6-16C	C12		B53, B112, B126		B112	2380N-04V04	B52, B125
02Y5-8-4C	C12	1068X-6-4	B53, B112, B126	192LX-4-3	B75	2380N-04V33	B55
02Y5-8-6C	C12	1069X-12-12	B44, B51, B68	192NX-6-05	B38	2380N-04V71	B52
02Y5-8-9C	C12		B44, B51, B68	192NX-6-06	B40	2380N-05V00	B58
02Y5-8-12C	C12	1069X-16-12	B44, B51, B68	192NX-8-06	B40	2380N-05V71	B58
02Y5-8-16C	C12		B46, B70	1AY8X-6-2A	B27	2390N-04V10	B60
02Y5-12-4C	C12	106EX-4-012	B3	1BCLX-4-4	B25	2390N-04V12	B60
02Y5-12-6C	C12	106HP-4-3	B120	1BCNX-4-4	B17, B35, B57, B123	2390N-04V16	B60
02Y5-12-9C	C12	106HP-4-4	B120			2390N-06V13	B63
02Y5-12-12C	C12	106HP-5-4	B120	1BCPX-4-4	B7	2390N-08V12	B65
02Y5-12-16C	C12	106HP-6-4	B120	1C38X-4-4	B54, B113, B128	2390N-08V13	B65
02Y5-16-6C	C12	106HP-6-6	B120			2390N-08V16	B65
02Y5-16-9C	C12	106NX-4-4	B16, B24, B34, B56, B123	1C3NX-8-4	B35, B124	2390N-12V03	B67
02Y5-16-12C	C12		B16, B24, B34, B56, B123	1C3PX-8-4	B7	2390N-16V12	B69
02Y5-16-16C	C12	106NX-6-4	B16, B24, B34, B56, B123	1C9NX-12-05	B38	2390N-16V13	B69
02Y6-2-4C	C22		B16, B24, B34, B56, B123	1C9NX-14-06	B40	2390N-16V16	B69
02Y6-2-6C	C22	106NX-6-05	B37, B47	1C9RS-16-08	B115	2440D-025V37	B71
02Y6-2-9C	C22	106NX-6-06	B39	1D98X-4-4	B54, B62, B113, B127	2440D-03V37	B73
02Y6-4-4C	C22	106NX-8-06	B39			2440N-04V37	B77
02Y6-4-6C	C22	106NX-20-20	B30	1D9LX-4-4	B25	2440N-04V91	B77
02Y6-4-9C	C22	106PX-4-4	B7	1D9NX-4-4	B17, B35, B57, B124	2440D-05V37	B80
02Y6-6-4C	C22	10K0101-12-12C	C29			2440N-06V91	B82
02Y6-6-6C	C22	10K0101-16-16C	C29	1D9PX-4-4	B8	2440N-08V30	B83
02Y6-6-9C	C22	10K0202-12-12C	C27	1MB8X-6-4	B54, B113, B127	2440N-08V91	B83
02Y6-8-4C	C22	10K0202-16-16C	C27			2440N-12V37	B85
02Y6-8-6C	C22	10KL02-12C	C27	1MBPX-6-4	B8	2440N-12V91	B85
02Y6-8-9C	C22	10KL02-16C	C27			2440N-16V37	B87
02Y6-12-6C	C22	10KT02-12C	C28	201RX-2-2C – 2X90N-06V04			
02Y6-12-9C	C22	10KT02-16C	C28	201RX-2-2C	B4	2440N-16V91	B87
02Y6-16-9C	C22	10KX02-12C	C28	2020N-012V30	B3	2440N-32V10	B89
		13BNX-6-05	B38	2020N-02V30	B4	2640D-025V32	B91
		13BNX-6-06	B40	2040N-04V00	B6	2640D-03V32	B93
		13BNX-8-06	B40	206RX-4-2C	B5	2640N-08V32	B95
		15K0101-1-1C	C29	216-200-18	E2	2640N-12V32	B97
		15K0101-2-2C	C29	220-200-22	E2	2640N-12V71	B97
		15K0101-4-4C	C29	2240D-02V32	B9	2640N-24V80	B99
		15K0101-6-6C	C29	2240D-025V34	B10	2640N-32V80	B101
				2240D-03V34	B13	2740D-025V30	B103
				2240D-04V32	B15	2740D-03V30	B105
				2240D-05V32	B18	2740D-05V32	B107
				2243D-025V70	B19	2840D-03V34	B108
						2840D-05V32	B109
						2840D-08V30	B110



Alphanumeric Index

Part Number	Page
2TURX-4-2C	B5
2X90N-04V14	B111
2X90N-06V14	B114
2X90N-08V14	B115
2X90N-08V14	B116
416-400-16 – 5YY6-16-9C	
416-400-16	E3
508-J-500-10	E2
510-A-500-12	E2
520-A-500-26	E2
57CR-6	B118
57CR-8	B118
57CR-16	B118
5Y01-4-2C	C11
5Y01-4-4C	C11
5Y01-4-6C	C11
5Y01-4-8C	C11
5Y01-4-12C	C11
5Y01-4-16C	C11
5Y01-6-2C	C11
5Y01-6-4C	C11
5Y01-6-6C	C11
5Y01-6-8C	C11
5Y01-6-12C	C11
5Y01-6-16C	C11
5Y01-9-2C	C11
5Y01-9-4C	C11
5Y01-9-6C	C11
5Y01-9-8C	C11
5Y01-9-12C	C11
5Y01-9-16C	C11
5Y01-12-2C	C11
5Y01-12-4C	C11
5Y01-12-6C	C11
5Y01-12-8C	C11
5Y01-12-12C	C11
5Y01-12-16C	C11
5Y01-16-2C	C11
5Y01-16-4C	C11
5Y01-16-6C	C11
5Y01-16-8C	C11
5Y01-16-12C	C11
5Y01-16-16C	C11
5Y02-4-2C	C15
5Y02-4-4C	C15
5Y02-4-6C	C15
5Y02-4-8C	C15
5Y02-4-12C	C15
5Y02-4-16C	C15
5Y02-6-2C	C15
5Y02-6-4C	C15
5Y02-6-6C	C15
5Y02-6-8C	C15
5Y02-6-12C	C15
5Y02-6-16C	C15
5Y02-9-2C	C15
5Y02-9-4C	C15
5Y02-9-6C	C15
5Y02-9-8C	C15
5Y02-9-12C	C15

Part Number	Page
5Y02-9-16C	C15
5Y02-12-2C	C15
5Y02-12-4C	C15
5Y02-12-6C	C15
5Y02-12-8C	C15
5Y02-12-12C	C15
5Y02-12-16C	C15
5Y02-16-2C	C15
5Y02-16-4C	C15
5Y02-16-6C	C15
5Y02-16-8C	C15
5Y02-16-12C	C15
5Y02-16-16C	C15
5Y5Y-4-4C	C13
5Y5Y-4-6C	C13
5Y5Y-4-9C	C13
5Y5Y-4-12C	C13
5Y5Y-4-16C	C13
5Y5Y-6-6C	C13
5Y5Y-6-9C	C13
5Y5Y-6-12C	C13
5Y5Y-6-16C	C13
5Y5Y-9-9C	C13
5Y5Y-9-12C	C13
5Y5Y-9-16C	C13
5Y5Y-12-12C	C13
5Y5Y-12-16C	C13
5Y5Y-16-16C	C13
5Y6Y-4-4C	C14
5Y6Y-4-6C	C14
5Y6Y-4-9C	C14
5Y6Y-6-4C	C14
5Y6Y-6-6C	C14
5Y6Y-6-9C	C14
5Y6Y-9-4C	C14
5Y6Y-9-6C	C14
5Y6Y-9-9C	C14
5Y6Y-12-4C	C14
5Y6Y-12-6C	C14
5Y6Y-12-9C	C14
5Y6Y-16-4C	C14
5Y6Y-16-6C	C14
5Y6Y-16-9C	C14
5YY5-4-6C	C9
5YY5-4-9C	C9
5YY5-4-12C	C9
5YY5-4-16C	C9
5YY5-6-4C	C9
5YY5-6-9C	C9
5YY5-6-12C	C9
5YY5-6-16C	C9
5YY5-9-4C	C9
5YY5-9-6C	C9
5YY5-9-12C	C9
5YY5-9-16C	C9
5YY5-12-4C	C9
5YY5-12-6C	C9
5YY5-12-9C	C9
5YY5-12-16C	C9
5YY5-16-4C	C9
5YY5-16-6C	C9
5YY5-16-9C	C9

Part Number	Page
5YY5-16-12C	C9
5YY6-4-4C	C10
5YY6-4-6C	C10
5YY6-4-9C	C10
5YY6-6-4C	C10
5YY6-6-6C	C10
5YY6-6-9C	C10
5YY6-9-4C	C10
5YY6-9-6C	C10
5YY6-9-9C	C10
5YY6-12-4C	C10
5YY6-12-6C	C10
5YY6-12-9C	C10
5YY6-16-4C	C10
5YY6-16-6C	C10
5YY6-16-9C	C10
6015X-32-24-TC – 6ZEAX-5-2A	
6015x-12-12C	B116
6015x-16-12C	B116
6015X-32-24-TC	B99
6015X-32-32-TC	B101
6018X-2-2A	B26
6018X-2-2AC	B26
6018X-4-2AC	B26
6018X-4-4	B52, B60, B111, B125
6018X-8-8C	B28
6019X-4-4C	B60
6019X-6-6	B63
6019X-6-6C	B63
6019X-8-6	B63
6019X-8-6C	B63
6019X-8-8	B41, B65
6019X-8-8C	B41, B48, B65
6019X-12-12	B43, B67
6019X-16-16C	B45, B69
601AX-1-2A	B10
601AX-2-2A	B10
601AX-2-3	B13, B20, B31
601AX-6-5	B18
601EX-2-012	B3
601EX-2-2	B4
601EX-4-012	B3
601LX-2-2AC	B71
601LX-2-4	B77
601LX-4-3	B13, B20, B31
601LX-4-4	B73
601LX-4-4C	B52, B77, B111, B125
601LX-4-5	B58, B80
601LX-4-5C	B58, B80
601LX-6-5	B58, B80
601LX-6-5C	B58, B80
601LX-8-8	B28, B83
601LX-8-8C	B83
601LX-12-12C	B67, B85
601LX-16-12C	B67, B85

Part Number	Page
601LX-16-16C	B87
601LX-32-32	B89
601NX-2-4	B15, B23, B33
601NX-4-4	B15, B23, B33
601NX-4-4C	B6, B15, B23, B33, B55, B122
601PL-1-2	B9B9
601RS-6-6	B114
601VX-2-2A	B19
602AX-1-2A	B11
602AX-2-3	B13, B21, B31
602NX-4-4	B16, B24, B34, B56
6065X-16-12C	B117
6068X-4-2AC	B27
6068X-8-8C	B29
6069X-4-4C	B53, B61, B112, B126
6069X-6-4C	B53, B61, B112, B126
6069X-8-6C	B64
6069X-8-8C	B42, B49, B66
6069X-16-16C	B46, B70
606AX-4-2A	B11
606AX-4-3C	B14, B22, B32
606CR-6-6C	B118
606CR-8-8C	B118
606CR-16-16C	B118
606LX-6-5C	B59
606LX-8-5C	B59
606LX-16-12C	B44, B51, B68, B86
606LX-16-16C	B88
606LX-32-32	B89
606NX-4-4C	B7, B16, B24, B34, B56, B123
606NX-6-4C	B7, B16, B24, B34, B56, B123
612-400-14	E2, E3
620-100-18	E2
63ZAX-5-2A	B12
63ZAX-5-3	B14, B22, B32
63ZAX-5-3C	B14, B22
63ZNX-5-4C	B17, B25, B36, B57
65Y8X-6-4	B53, B62, B112, B126
65YLX-6-3	B75
65YLX-6-4	B79
65YLX-6-4C	B53, B62, B79, B112, B126
66Y5X-4-3	B94
66Y5X-4-3C	B94
66YHX-4-2AC	B92, B104
66YHX-4-3C	B106
66YLX-4-3	B74
66YLX-4-3C	B74

Alphanumeric Index

Part Number	Page	Part Number	Page	Part Number	Page	Part Number	Page
6928X-4-4	B110, B127	6C9RS-14-6	B114	6Y2LX-12-5C	B81	80C-F04G	E4
692HX-4-3C	B106	6D9NX-8-8-PL	B28	6Y2LX-12-8C	B84	80C-F06G	E4
692LX-4-3C	B75	6C9RS-14-6	B114	6Y2LX-16-12C	B86	80C-F10G	E4
692LX-4-4	B78	6EYLX-6-3C	B76	6Y4HX-4-2AC	B92, B103	80C-F12G	E4
692LX-6-5C	B81	6EYLX-6-4C	B79	6Y4HX-6-2AC	B92, B103	83C-F16G	E4
6AY5X-6-3	B93	6EYLX-9-5C	B81	6Y4HX-6-3C	B105	80C-F08W	E4
6AY5X-6-3C	B93	6EZAX-5-2A	B12	6Y4HX-9-3C	B105	80C-G03	B117, E4
6AY5X-11-8C	B95	6HE5X-32-24-TC	B100	6Y4HX-9-5C	B107	80C-G04	B117, E4
6AY5X-16-12C	B97, B116	6HE5X-32-32-TC	B102	6Y4HX-9-5C-XLT	B107	80C-G06	B117, E4
6AY5X-16-12C-SD	B97, B116	6HELX-16-16-TC	B88	6Y4LX-4-2AC	B72	80C-HP3	E4
6AY8X-6-2AC	B27	6HELX-32-32-TC	B90	6Y4LX-6-2AC	B72	80C-HP4	B117, E4
6AY8X-6-4	B52, B61	6HN5X-32-24-TC	B100	6Y4LX-6-3C	B74	80C-HP6	B117
	B111, B126	6HN5X-32-32-TC	B102	6Y4LX-9-3C	B74	80C-R01-PFD	E5
6AY8X-8-5C	B59	6HNLX-16-16-TC	B88	6Y4WX-16-08C	B110	80C-YP6	E4
6AY8X-11-8C	B29	6HNLX-32-32-TC	B90	6Y4WX-6-3C	B108	82C-R01-PFD	E5
6AY9X-6-4C	B61	6HYPL-1-2	B9	6Y4WX-9-3C	B108	82C-R02-PFD	E5
6AY9X-8-6C	B64	6HYLX-4-2AC	B72	6Y4WX-9-5C	B109	83C-081-PFD	E5
6AY9X-11-8C	B42, B49, B66	6HYLX-6-3C	B76	6Y4WX-9-5C-RCS	B109	83C-9X04	E4
6AY9X-16-16C	B46, B70	6HYLX-6-4C	B79	6Y45X-6-3C	B93	83C-9X08	E4
6AYAX-6-2A	B11	6HYLX-9-5C-LH	B81	6Y45X-9-3C	B93	83C-9X16	E4
6AYAX-6-3	B14, B21, B32	6Y01-4-2C	C21	6Y6Y-4-4C	C23	83C-F16W	E4
6AYHX-6-2AC	B91, B103	6Y01-4-4C	C21	6Y6Y-4-6C	C24	94C-080-PFD	E5
6AYHX-6-3C	B105	6Y01-4-6C	C21	6Y6Y-4-9C	C24		
6AYHX-8-5C	B107	6Y01-4-8C	C21	6Y6Y-6-6C	C23		
6AYHX-10-5C	B107	6Y01-4-12C	C21	6Y6Y-6-9C	C24		
6AYHX-13-5C	B105	6Y01-4-16C	C21	6Y6Y-9-9C	C23		
6AYLX-6-2AC	B71	6Y01-6-2C	C21	6YHLX-4-2AC-LH	B72	AV5Y-4C-20 – E408LCA3	
6AYLX-6-3	B14, B21, B32, B73	6Y01-6-4C	C21	6YHLX-6-3C	B74	AV5Y-4C-20	C31
6AYLX-6-3C	B73	6Y01-6-6C	C21	6YHLX-4-3C-LH	B74	AV5Y-6C-20	C31
6AYLX-6-4	B78	6Y01-6-8C	C21	6YHLX-6-3C-LH	B74	AV5Y-9C-20	C31
6AYLX-6-4C	B52, B78	6Y01-6-12C	C21	6YHLX-6-4C-LH	B78	AV5Y-12C-20	C31
	B111, B126	6Y01-6-16C	C21	6YHLX-6-4C	B78	AV5Y-16C-20	C31
6AYLX-6-4C-SD	B52, B78, B111, B125	6Y01-9-2C	C21	6YY5-4-4C	C10	AV6Y-4C-30	C33
6AYLX-8-5C	B80	6Y01-9-4C	C21	6YY5-4-6C	C10	AV6Y-4C-60	C35
6AYLX-8-6C	B82	6Y01-9-6C	C21	6YY5-4-9C	C10	AV6Y-6C-30	C33
6AYLX-11-8C	B29, B84	6Y01-9-8C	C21	6YY5-4-12C	C10	AV6Y-6C-60	C35
6AYLX-11-8C-SD	B29, B84	6Y01-9-12C	C21	6YY5-4-16C	C10	AV6Y-9C-30	C33
	B84	6Y01-9-16C	C21	6YY5-6-4C	C10	AV6Y-9C-60	C35
6AYLX-16-12C	B44, B51	6Y02-4-2C	C24	6YY5-6-6C	C10	AY6C-CAP	C5
	B68, B85	6Y02-4-4C	C24	6YY5-6-9C	C10	AY8C-CAP	C5
6AYLX-16-12C-SD	B85	6Y02-4-6C	C24	6YY5-6-12C	C10	AY11C-CAP	C5
6AYLX-16-16C	B87	6Y02-4-8C	C24	6YY5-6-16C	C10	AY16C-CAP	C5
6AYLX-16-16C-SD	B87	6Y02-4-12C	C24	6YY5-6-16C	C10	C09-125-1680	D15
6AYLX-16-16-HCL	B87	6Y02-4-16C	C24	6YY5-9-4C	C10	C10-115-1202	D10
6AYLX-32-32-Flat	B90	6Y02-6-2C	C24	6YY5-9-6C	C10	C10-115-1222	D10
6AYNX-6-4	B16, B24	6Y02-6-4C	C24	6YY5-9-9C	C10	C10-115-1401	D10
	B34, B56, B123	6Y02-6-6C	C24	6YY5-9-12C	C10	C10-115-1402	D10
6AYNX-6-4C	B6, B16, B24, B34, B56, B123	6Y02-6-8C	C24	6YY5-9-16C	C10	C10-115-1404	D10
6AYWX-6-3C	B108	6Y02-6-12C	C24	6YY6-4-6C	C21	C10-115-1422	D10
6AYWX-6-3C-55	B108	6Y02-6-16C	C24	6YY6-4-9C	C21	C10-115-1452	D10
6AYWX-10-5C	B109	6Y02-9-2C	C24	6YY6-6-4C	C21	C10-115-1454	D10
6AYWX-10-5C-55	B109	6Y02-9-4C	C24	6YY6-6-9C	C21	C10-115-1454	D10
6C95X-16-8C	B96	6Y02-9-6C	C24	6YY6-9-4C	C21	C10-115-6202	D11
6C95X-25-12C	B98, B117	6Y02-9-8C	C24	6YY6-9-6C	C21	C10-115-6204	D11
6C9LX-16-8C	B29, B84	6Y02-9-12C	C24	6ZEAX-1-2A	B12	C10-115-6401	D11
6C9LX-25-12C	B86	6Y02-9-16C	C24	6ZEAX-5-2A	B12	C10-115-6402	D11
6C9RS-14-6	B114, B86	6Y25X-9-8C	B96	6ZELX-5-3C	B75	C10-115-6404	D11
		6Y25X-12-8C	B96			C10-115-6452	D11
		6Y25X-16-12C	B98, B117			C10-115-6454	D11
		6Y2LX-9-5C	B81			C10-116-1202	D12
		6Y2LX-9-6C	B82	80C-001-PFD – 94C-080-PFD		C10-116-1222	D12
		6Y2LX-9-8C	B84	80C-001-PFD	E5	C10-116-1402	D12
				80C-081-PFD	E5	C10-116-1422	D12
						C10-116-5202	D13



Alphanumeric Index

Part Number	Page	Part Number	Page	Part Number	Page	Part Number	Page
C10-116-6202	D13	HP006-1-NMB	D4	M55STIF4	E3	SV5Y-6C-20	C30
C10-116-6402	D13	HP006-1-NMC	D4	MBR003	E3	SV5Y-9C-20	C30
C10-125-1202	D13	HP006-1-NMD	D4	MBR007	E3	SV6Y-4C-30	C33
C10-125-5202	D14	HP006-1-X13	D4	MBR008	E3	SV6Y-4C-60	C35
C10-125-6202	D14	HP006-2-A9	D5	MBR009	E3	SV6Y-6C-30	C33
C19-950-0029	D15	HP006-2-A12	D5	MBR010	E3	SV6Y-6C-60	C35
C19-950-0062	D15	HP006-2-HM4	D5	MBR012	E3	SV6Y-9C-30	C33
C19-950-0064	D15	HP006-2-LM6	D5	MBR013-B	E3	SV6Y-9C-60	C35
C19-950-1600	D15	HP006-2-NFB	D5	MBR2104	E3	SV5Y-12C-20	C30
C19-950-1601	D15	HP006-2-NFC	D5	MCG001SS	E2	SV5Y-16C-20	C30
C19-950-1602	D15	HP006-2-NMB	D5	MCG002SS	E2	T5Y-4C	C18
C19-950-1622	D15	HP006-2-NMC	D5	MCG003SS	E2	T5Y-6C	C18
C19-950-1623	D15	HP006-2-NMD	D5	MCG005SS	E2	T5Y-9C	C18
C19-950-1680	D15	HP006-2-X13	D5	MCG014-02-1523	E2	T6Y-4C	C25
CV5Y-4C-20	C32	HP010-0-A12	D6	MCG014-02-1524	E2	T6Y-6C	C25
CV5Y-6C-20	C32	HP010-0-A16	D6	MCGHS10-15	E2	T6Y-9C	C25
CV5Y-9C-20	C32	HP010-0-LM12	D6	MCGHS15-20	E2	T5Y-12C	C18
CV6Y-4C-60	C36	HP010-0-NFD	D6	MCGHS20-30	E2	T5Y-16C	C18
CV6Y-6C-60	C36	HP010-0-NMD	D6	MCGHS30-40	E2	TV15Y-4C-20	C32
CV6Y-9C-60	C36	HP010-0-X23	D6	MCGHS40-50	E2	TV15Y-6C-20	C32
E204UZD1	B12	HP010-1-A12	D7	MCGHS50-60	E2	TV15Y-9C-20	C32
E206JCC3	B61	HP010-1-A16	D7	MHBS012	E3	TV15Y-12C-20	C32
E206JEC3	B61	HP010-1-LM12	D7	MHBS016	E3	TV15Y-16C-20	C32
E213JFC4	B66	HP010-1-LM9	D7	MHDC010	E2	TV16Y-4C-30	C34
E225JIC3	B70	HP010-1-NMD	D7	MHDC011	E2	TV16Y-4C-60	C36
E408LCA2	B81	HP010-1-X23	D7	MHDC012	E2	TV16Y-6C-30	C34
E408LCA3	B81	HP010-2-A12	D8	MHDC014	E2	TV16Y-6C-60	C36
HAHM4BM4 – HPG6-23K-ORG				MHDC016	E2	TV16Y-9C-30	C34
HAHM4BM4	D15	HP010-2-A16	D8	MHDC018	E2	TV16Y-9C-60	C36
HBPHM4-B	C26	HP010-2-NFD	D8	MHDC020	E2	TV25Y-4C-20	C31
HBPHM6-B	C26	HP010-2-NMD	D8	MHDC022	E2	TV25Y-6C-20	C31
HBPHM9-B	C26	HP010-2-X23	D8	MHDC024	E2	TV25Y-9C-20	C31
HBPLM12-B	C19	HP8-3	B119	MHDC026	E2	TV25Y-12C-20	C31
HBPLM16-B	C19	HP8-4	B119	MHDC032	E2	TV25Y-16C-20	C31
HBPLM4-B	C19	HP8-6	B119	MK022-03-038	E3	TV26Y-4C-30	C34
HBPLM6-B	C19	HPG3-12K	B119, B121	MK022-03-039	E3	TV26Y-4C-60	C36
HBPLM9-B	C19	HPG3-12K-ORG	B119, B121	MK022-03-041	E3	TV26Y-6C-30	C34
HP-3	B119	HPG3-23K	B119, B121	MK022-03-042	E3	TV26Y-6C-60	C36
HP-3-Gauge	E4	HPG3-23K-ORG	B119, B121	MK022-03-043	E3	TV26Y-9C-30	C34
HP-4	B119	HPG3-23K-ORG	B119, B121	MK022-03-045	E3	TV26Y-9C-60	C36
HP-4-Gauge	E4	HPG4-12K	B119, B121	MSG060	E2	WB-501-8FP – YAYA-16-16C	
HP-6	B119	HPG4-12K-ORG	B119, B121	MSG1006	E2	WB-501-8FP	D17
HP-6-Gauge	E4	HPG4-23K	B119, B121	MSG2006	E2	WB-502-8FP	D17
HP006-0-A9	D3	HPG4-23K-ORG	B119, B121	MSG2106	E2	X5Y-4C	C18
HP006-0-A12	D3	HPG6-12K	B119, B121	MSG4113	E2	X5Y-6C	C18
HP006-0-HM4	D3	HPG6-12K-ORG	B119, B121	MSG4120	E2	X5Y-9C	C18
HP006-0-HM9	D3	HPG6-23K	B119, B121	MSG4125	E2	X5Y-12C	C18
HP006-0-LM6	D3	HPG6-23K-ORG	B119, B121	MSG6020	E2	X5Y-16C	C18
HP006-0-NFB	D3	HPG6-23K-ORG	B119, B121	MTM04T	E3	X6Y-4C	C25
HP006-0-NFC	D3			PUF 011 – TV26Y-9C-60			
HP006-0-NMB	D3			PUF 010	B118	X6Y-6C	C25
HP006-0-NMC	D3			PUF 011	B118	X6Y-9C	C25
HP006-0-NMD	D3			PUF 013	B118	Y2C-4C	C19
HP006-0-X13	D3			PUF 015	B118	Y2C-6C	C19
HP006-1-A9	D4			PUF 101	B118	Y2C-9C	C19
HP006-1-A12	D4			PUM 001	B118	Y2C-12C	C19
HP006-1-HM4	D4			PUM 002	B118	Y2C-16C	C19
HP006-1-LM6	D4			PUM 004	B118	Y2N-12C	C19
HP006-1-LM9	D4			PUM 005	B118	Y2N-16C	C19
HP006-1-LM9	D4			PUM 009	B118	Y2N-4C	C19
				SV5Y-4C-20	C30		
				L5Y-4C – MTM04T			
L5Y-4C	C17						
L5Y-6C	C17						
L5Y-9C	C17						
L5Y-12C	C17						
L5Y-16C	C17						
L6Y-4C	C25						
L6Y-6C	C25						
L6Y-9C	C25						

Alphanumeric Index

Part Number	Page	Part Number	Page	Part Number	Page	Part Number	Page
Y2N-6C	C19	Y404-0300C	C26	Y5Y5-12-12C	C16	YA01-8-16C	C7
Y2N-9C	C19	Y404-0400C	C26	Y5Y5-12-16C	C16	YA01-11-6C	C7
Y4C-4C	C26	Y404-0600C	C26			YA01-11-8C	C7
Y4C-6C	C26	Y404-0800C	C26	Y5Y6-4-4C	C16	YA01-11-12C	C7
Y4C-9C	C26	Y404-1000C	C26	Y5Y6-4-6C	C16	YA01-11-16C	C7
Y4N-4C	C26	Y404-1200C	C26	Y5Y6-4-9C	C16	YA01-16-12C	C7
Y4N-6C	C26	Y406-0300C	C26	Y5Y6-6-4C	C16	YA01-16-8C	C7
Y4N-9C	C26	Y406-0600C	C26	Y5Y6-6-9C	C16	YA01-16-16C	C7
Y4NC-4C-AV	C26	Y406-0800C	C26	Y5Y6-9-4C	C16	YA01-16-20C	C7
Y4NC-6C-AV	C26	Y406-1000C	C26	Y5Y6-9-9C	C16	YA01-16-24C	C7
Y4NC-9C-AV	C26	Y406-1200C	C26	Y5Y6-12-4C	C16	YA01-16-32C	C7
		Y409-0400C	C26	Y5Y6-12-6C	C16		
		Y409-0600C	C26	Y5Y6-12-9C	C16	YA02-6-4C	C6
		Y409-0800C	C26	Y5Y6-16-4C	C16	YA02-6-8C	C6
		Y409-1000C	C26	Y5Y6-16-6C	C16	YA02-8-8C	C6
		Y409-1200C	C26	Y5Y6-16-9C	C16	YA02-11-8C	C6
		Y501-4-4C	C17	Y601-4-2C	C23	YA6C-PLUG	C5
Y204-0275C	C19	Y501-4-8C	C17	Y601-4-4C	C23	YA8C-PLUG	C5
Y204-0300C	C19	Y501-6-4C	C17	Y601-4-6C	C23	YA11C-PLUG	C5
Y204-0400C	C19	Y501-6-6C	C17	Y601-4-8C	C23	YA16C-PLUG	C5
Y204-0600C	C19	Y501-6-8C	C17	Y601-4-12C	C23		
Y204-0800C	C19	Y501-9-2C	C17	Y601-6-4C	C23	YAY1-8-16C	C5
Y204-1000C	C19	Y501-9-4C	C17	Y601-6-6C	C23	YAY1-11-16C	C5
Y204-1200C	C19	Y501-9-6C	C17	Y601-9-4C	C23	YAY1-16-16C	C5
		Y501-9-8C	C17	Y601-9-6C	C23		
Y206-0300C	C19	Y501-9-12C	C17	Y601-9-8C	C23	YAY2-8-16C	C5
Y206-0400C	C19	Y501-9-16C	C17	Y601-9-12C	C23	YAY2-11-16C	C5
Y206-0600C	C19	Y501-12-2C	C17	Y601-9-16C	C23	YAY2-16-16C	C5
Y206-0800C	C19	Y501-12-4C	C17				
Y206-1000C	C19	Y501-12-6C	C17	Y6Y6-4-4C	C22	YAY5-6-4C	C6
Y206-1200C	C19	Y501-12-8C	C17	Y6Y6-4-6C	C22	YAY5-6-6C	C6
		Y501-12-12C	C17	Y6Y6-4-9C	C22	YAY5-6-9C	C6
Y209-0400C	C19	Y501-12-16C	C17	Y6Y6-6-6C	C22	YAY5-6-12C	C6
Y209-0600C	C19	Y501-16-2C	C17	Y6Y6-6-9C	C22	YAY5-8-6C	C6
Y209-0800C	C19	Y501-16-12C	C17	Y6Y6-9-9C	C22	YAY5-8-9C	C6
Y209-1000C	C19	Y501-16-16C	C17			YAY5-8-12C	C6
Y209-1200C	C19	Y501-16-4C	C17	YA01-6-2C	C7	YAY5-11-6C	C6
		Y501-16-6C	C17	YA01-6-4C	C7	YAY5-11-9C	C6
		Y501-16-8C	C17	YA01-6-6C	C7	YAY5-11-12C	C6
Y212-0400C	C19			YA01-6-8C	C7	YAY5-16-9C	C6
Y212-0600C	C19	Y5Y5-4-4C	C16	YA01-8-4C	C7	YAY5-16-12C	C6
Y212-0800C	C19	Y5Y5-4-6C	C16	YA01-8-6C	C7		
Y212-1000C	C19	Y5Y5-4-12C	C16	YA01-8-8C	C7	YAY6-6-4C	C4
Y212-1200C	C19	Y5Y5-4-16C	C16	YA01-8-12C	C7	YAY6-6-6C	C4
		Y5Y5-6-6C	C16			YAY6-6-9C	C4
Y216-0600C	C19	Y5Y5-6-9C	C16			YAY6-8-6C	C4
Y216-0800C	C19	Y5Y5-6-12C	C16			YAY6-8-9C	C4
Y216-1000C	C19	Y5Y5-6-16C	C16			YAY6-10-6C	C4
Y216-1200C	C19	Y5Y5-9-9C	C16			YAY6-10-9C	C4
		Y5Y5-9-12C	C16			YAY6-11-9C	C4
Y404-0275C	C26	Y5Y5-9-16C	C16				
						YAYA-6-6C	C4
						YAYA-8-6C	C4
						YAYA-8-8C	C4
						YAYA-10-6C	C4
						YAYA-10-10C	C4
						YAYA-11-8C	C4
						YAYA-11-11C	C4
						YAYA-16-11C	C4
						YAYA-16-16C	C4



Offer of Sale

The items described in this document are hereby offered for sale at prices to be established by Parker Hannifin Corporation, its subsidiaries and its authorized distributors. This offer and its acceptance by any customer ("Buyer") shall be governed by all of the following Terms and Conditions. Buyer's order for any item described in this document, when communicated to Parker Hannifin Corporation, its subsidiary or an authorized distributor ("Seller") verbally or in writing, shall constitute acceptance of this offer.

- 1. Terms and Conditions of Sale:** All descriptions, quotations, proposals, offers, acknowledgments, acceptances and sales of Seller's products are subject to and shall be governed exclusively by the terms and conditions. Any terms or conditions in addition to, or inconsistent with those stated herein, proposed by Buyer in any acceptance of an offer by Seller, are hereby objected to. No such additional, different or inconsistent terms and conditions shall become part of the contract between Buyer and Seller unless expressly accepted in writing by Seller. Seller's acceptance of any offer to purchase by Buyer is expressly conditional upon Buyer's assent to all the terms and conditions stated herein, including any terms in addition to, or inconsistent with those contained in Buyer's offer. Acceptance of Seller's products shall in all events constitute assent.
- 2. Payment:** Payment shall be made by Buyer net 30 days from the date of delivery of the items purchased hereunder. Amounts not timely paid shall bear interest at the rate of 1-1/2% for each month or a portion thereof that Buyer is late in making payment. Any claims by Buyer for omissions or shortages in a shipment shall be waived unless Seller receives notice thereof within 30 days after Buyer's receipt of the shipment.
- 3. Delivery:** Unless otherwise provided on the face hereof, delivery shall be made F.O.B. Seller's plant. Regardless of the method of delivery, however, risk of loss shall pass to Buyer upon Seller's delivery to a carrier. Any delivery dates shown are approximate only and Seller shall have no liability for delays in delivery.
- 4. Warranty:** Seller warrants that the items sold hereunder shall be free from defects in materials or workmanship for a period of 365 days from the date of shipment to Buyer, or 2,000 hours of use, whichever expires first. **THIS WARRANTY COMPRISES THE SOLE AND ENTIRE WARRANTY PERTAINING TO ITEMS PROVIDED HEREUNDER. SELLER MAKES NO OTHER WARRANTY, GUARANTEE, OR REPRESENTATIONS OF ANY KIND WHATSOEVER. ALL OTHER WARRANTIES, INCLUDING BUT NOT LIMITED TO, MERCHANTABILITY AND FITNESS FOR PURPOSE, WHETHER EXPRESS, IMPLIED, OR ARISING BY OPERATION OF LAW, TRADE USAGE, OR COURSE OF DEALING ARE HEREBY DISCLAIMED.**
NOTWITHSTANDING THE FOREGOING, THERE ARE NO WARRANTIES WHATSOEVER ON ITEMS BUILT OR ACQUIRED WHOLLY OR PARTIALLY, TO BUYER'S DESIGNS OR SPECIFICATIONS.
- 5. Limitation Of Remedy:** SELLER'S LIABILITY ARISING FROM OR IN ANY WAY CONNECTED WITH THE ITEMS SOLD OR THIS CONTRACT SHALL BE LIMITED EXCLUSIVELY TO REPAIR OR REPLACEMENT OF THE ITEMS SOLD, OR REFUND OF THE PURCHASE PRICE PAID BY BUYER, AT SELLER'S SOLE OPTION. IN NO EVENT SHALL SELLER BE LIABLE FOR ANY INCIDENTAL, CONSEQUENTIAL OR SPECIAL DAMAGES OF ANY KIND OR NATURE WHATSOEVER, INCLUDING BUT NOT LIMITED TO LOST PROFITS ARISING FROM OR IN ANY WAY CONNECTED WITH THIS AGREEMENT OR ITEMS SOLD HEREUNDER, WHETHER ALLEGED TO ARISE FROM BREACH OF CONTRACT, EXPRESS OR IMPLIED WARRANTY, OR IN TORT, INCLUDING WITHOUT LIMITATION, NEGLIGENCE, FAILURE TO WARN OR STRICT LIABILITY.
- 6. Changes, Reschedules and Cancellations:** Buyer may request to modify the designs or specifications for the item sold hereunder as well as the quantities and delivery dates thereof, or may request to cancel all or part of this order, however, no such requested modification or cancellation shall become part of the contract between Buyer and Seller unless accepted by Seller in a written amendment to this Agreement. Acceptance of any such requested modification of cancellation shall be at Seller's discretion, and shall be upon such terms and conditions as Seller may require.
- 7. Special Tooling:** A tooling charge may be imposed for any special tooling, including without limitation, dies, fixtures, molds and patterns, acquired to manufacture items sold pursuant to this contract. Such special tooling shall be and remain Seller's property notwithstanding payment of any charges therefor by Buyer. In no event will Buyer acquire any interest in apparatus belonging to Seller which is utilized in the manufacture of the items sold hereunder, even if such apparatus has been specially converted or adapted for such manufacture and notwithstanding any charges paid by Buyer therefor. Unless otherwise agreed, Seller shall have the right to alter, discard or otherwise dispose of any special tooling or other property in its sole discretion at any time.
- 8. Buyer's Property:** Any designs, tools, patterns, materials, drawings, confidential information or equipment furnished by Buyer, or any other items which become Buyer's property, may be considered obsolete and may be destroyed by Seller after two (2) consecutive years have elapsed without Buyer placing an order for the items which are manufactured using such property. Seller shall not be responsible for any loss or damage to such property while it is in Seller's possession or control.
- 9. Taxes:** Unless otherwise indicated on the face hereof, all prices and charges are exclusive of excise, sales, use, property, occupational or like taxes which may be imposed by any taxing authority upon the manufacture, sale or delivery of the items sold hereunder. If any such taxes must be paid by Seller, or if Seller is liable for the collection of such tax, the amount thereof shall be in addition to the amounts for the items sold. Buyer agrees to pay all such taxes or to reimburse Seller therefor upon receipt of its invoice. If Buyer claims exemption from any sales, use or other tax imposed by any taxing authority, Buyer shall save Seller harmless from and against any such tax, together with any interest or penalties thereon which may be assessed if the items are held to be taxable.
- 10. Indemnity For Infringement of Intellectual Property Rights:** Seller shall have no liability for infringement of any patents, trademarks, copyrights, trade dress, trade secrets or similar rights except as provided in this Part 10. Seller will defend and indemnify Buyer against allegations of infringement of U.S. patents, U.S. trademarks, copyrights, trade dress and trade secrets (hereinafter 'Intellectual Property Rights'). Seller will defend at its expense and will pay the cost of any settlement or damages awarded in an action brought against Buyer based on an allegation that an item sold pursuant to this contract infringes the Intellectual Property Rights of a third party. Seller's obligation to defend and indemnify Buyer is contingent on Buyer notifying Seller within ten (10) days after Buyer becomes aware of such allegations of infringement, and Seller having sole control over the defense of any allegations or actions, including all negotiations for settlement or compromise. If an item sold hereunder is subject to a claim that it infringes the Intellectual Property Rights of a third party, Seller may, at its sole expense and option, procure for Buyer the right to continue using said item, replace or modify said item so as to make it noninfringing, or offer to accept return of said item and return the purchase price less a reasonable allowance for depreciation.

Notwithstanding the foregoing, Seller shall have no liability for claims of infringement based on information provided by Buyer, or directed to items delivered hereunder for which the designs are specified in whole or part by Buyer, or infringements resulting from the modification, combination or use in a system of any item sold hereunder. The foregoing provisions of this Part 10 shall constitute Seller's sole and exclusive liability and Buyer's sole and exclusive remedy for infringement of Intellectual Property Rights.

If a claim is based on information provided by Buyer or if the design for an item delivered hereunder is specified in whole or in part by Buyer, Buyer shall defend and indemnify Seller for all costs, expenses or judgements resulting from any claim that such an item infringes any patent, trademark, copyright, trade dress, trade secret or any similar right.
- 11. Force Majeure:** Seller does not assume the risk of and shall not be liable for delay or failure to perform any of Seller's obligations by reason of circumstances beyond the reasonable control of Seller (hereinafter 'Events of Force Majeure'). Events of Force Majeure shall include without limitation, accidents, acts of God, strikes or labor disputes, acts, laws, rules or regulations of any government or government agency, fires, floods, delays or failures in delivery of carriers or suppliers, shortages of materials and any other cause beyond Seller's control.
- 12. Entire Agreement/Governing Law:** The terms and conditions set forth herein, together with any amendments, modifications and any different terms or conditions expressly accepted by Seller in writing, shall constitute the entire Agreement concerning the items sold, and there are no oral or other representations or agreements which pertain thereto. This Agreement shall be governed in all respects by the law of the State of Ohio. No actions arising out of the sale of the items sold hereunder or this Agreement may be brought by either party more than two (2) years after the cause of action accrues.

Fluid Connectors Group Regional Sales Offices & Service Centers

Your complete source for quality tube fittings, hose & hose fittings, brass fittings & valves, quick-disconnect couplings, and assembly tools, locally-available from a worldwide network of authorized distributors.

Fittings & Couplings: Available in inch and metric sizes covering SAE, BSP, DIN, GAZ, JIS and ISO thread configurations, manufactured from steel, stainless steel, brass, aluminum, nylon and thermoplastic.

Hose, Tubing and Bundles: Available in a wide variety of sizes and materials including rubber, wire-reinforced thermoplastic, hybrid and custom compounds.

Worldwide Availability: Parker operates Fluid Connectors manufacturing locations and sales offices throughout North America, South America, Europe and Asia-Pacific.

For information, contact the nearest Regional Sales Office listed, or **call toll-free 1-800-C-PARKER** (1-800-272-7537).

**Central Region
Sales Office & Service Center**
Hiawatha, IA
(319) 393-1221
(319) 393-1224 FAX

**Cleveland Region
Sales Office**
Cleveland, OH
(216) 896-3000
(216) 896-4022 FAX
Service Center
Toledo, OH
(419) 878-7000
(419) 878-7001 FAX

**Great Lakes Region
Sales Office & Service Center**
Otsego, MI
(269) 694-2550
(269) 692-6634 FAX
Service Center
Toledo, OH
(419) 878-7000
(419) 878-7001 FAX
Service Center
Ft. Wayne, IN
(260) 747-3111
(260) 747-3026 FAX

**Minneapolis Region
Sales Office & Service Center**
Minneapolis, MN
(952) 469-5000
(952) 469-5729 FAX
Service Center
(920) 426-8471
(920) 426-8570 FAX

**Northeast Region
Sales Office & Service Center**
Trenton, NJ
(609) 586-5151
(609) 586-3149 FAX

**Pacific Region
Sales Office & Service Center**
Portland, OR
(503) 283-1020
(503) 283-2201 FAX
Service Center
Buena Park, CA
(714) 522-8840
(714) 994-1183 FAX

**Southeast Region
Sales Office & Service Center**
Greensboro, NC
(336) 373-1761
(336) 378-0913 FAX
Service Center
Conyers, GA
(770) 929-0330
(770) 929-0230 FAX

**Southwest Region
Sales Office & Service Center**
Mansfield, TX
(817) 473-4431
(817) 473-8078 FAX

**Canada
Sales Office & Service Center**
Grimsby, ON
(905) 945-2274
(905) 945-3946 FAX
(Contact Grimsby for other Service Center locations.)



Parker Hannifin Corporation
Energy Products Division
11151 Cash Road
Stafford, TX 77477
Tel: (281) 566-4500
Fax: (281) 582-5271

Catalog 4900, 1/06 REVISED