



# Automation Technologies

Electromechanical Products and System Solutions

aerospace  
climate control  
electromechanical  
filtration  
fluid & gas handling  
hydraulics  
pneumatics  
process control  
sealing & shielding



ENGINEERING YOUR SUCCESS.

[www.comoso.com](http://www.comoso.com)

# Parker Hannifin Corporation

With annual sales exceeding \$13 billion, Parker Hannifin is the world's leading diversified manufacturer of motion and control technologies and systems, providing precision-engineered solutions for a wide variety of mobile, industrial, and aerospace markets.

We have more than 300 manufacturing plants worldwide and are the only company to offer our customers a choice of hydraulic, pneumatic, electromechanical, and computer motion control solutions.

Parker employs approximately 57,500 people in 50 countries. Additionally, we have the largest global distribution network in our field, with more than 13,000 distributors serving over 450,000 customers in 1,100 markets.



Global Headquarters: Cleveland, Ohio

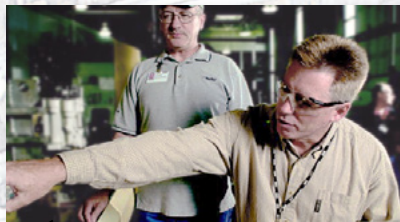

Engineering Expertise



Premier Customer Service



Worldwide Support Network

## Innovative Automation Products and System Solutions

The Parker Electromechanical Division brings together leading brands in industrial automation, including **Acroloop, Bayside, Compumotor, CTC, Custom Servo Motor, Daedal, Hauser, IPS, and Trilogy.**

When it comes to electromechanical components and solutions, Parker provides an unmatched product portfolio with solutions ranging from the mechanics through the software.

This shortform catalog is designed to provide you with a brief overview and understanding of our featured electromechanical product technologies.

For complete information on these products or to discuss your next solution, contact Parker today.

- For access to complete information on our website, use the web address listed with the products in this shortform catalogue
- For literature, call 800-358-9070, e-mail us at [ddl\\_cat@parker.com](mailto:ddl_cat@parker.com), or visit us online at [www.parker.com/emn](http://www.parker.com/emn)
- For information on software and training programs, visit [www.parkermotion.com/support\\_training.html](http://www.parkermotion.com/support_training.html)

# Automation Technologies

**High Quality Automation Solutions** . . . . . 4 - 5

**Selectable Levels of Integration™** . . . . . 6 - 7

**The Fundamental Elements of Motion and Machine Control** . . . . . 8 - 9

**HMI** **Visualization & HMI** . . . . . 10 - 14  
*Selection Guide* . . . . . 10  
HMI PowerStations and software . . . 10 - 14

**MC** **Motion & Machine Control** . . . . . 15 - 19  
*Selection Guide* . . . . . 15  
PAC integrated machine control . . . . 15  
Parker Automation Manager IDE . . . . 17  
ACR automation control . . . . . 19

**DR** **Drives & Controllers** . . . . . 20 - 25  
*Selection Guide* . . . . . 20  
Servo drives and drive/controllers . . 21 - 23  
Stepper drives and drive/controllers . 24 - 25

**MO** **Rotary & Linear Motors** . . . . . 26 - 34  
*Selection Guide* . . . . . 26 - 37  
Servo motors . . . . . 28 - 32  
Stepper motors . . . . . 32 - 33  
Linear motors . . . . . 33 - 34

**GH** **Gearheads & Gearmotors** . . . . . 35 - 36  
*Selection Guide* . . . . . 35  
Planetary and NEMA gearheads . . . . 35  
MultiDrive gearheads . . . . . 36  
Integral gearmotor solutions . . . . . 36

**EP** **Linear & Rotary Positioners** . . . . . 37 - 49  
*Selection Guide* . . . . . 37 - 38  
Linear positioners . . . . . 40 - 47  
Rotary positioners . . . . . 48 - 49

**MP** **Manually Driven Positioning Slides & Stages** . . . . . 50 - 51

**EC** **Electric Cylinders** . . . . . 52 - 53  
*Selection Guide* . . . . . 52

**IPS** **T-Slot Aluminum Framing** . . . . . 54 - 55

**S** **Engineered Solutions** . . . . . 56 - 58

**Online Resources** . . . . . 59

**International Sales Locations** . . . . . Back cover



## If you don't find what you're looking for...

Parker electromechanical automation products are found just about everywhere—from research laboratories, semiconductor plants, and other automated factory processes, to mines, foundries and satellites in space. Our products are used everywhere machines, processes, and people depend on reliable high-performance motion control.

The products described in this catalog represent our most popular products and capabilities. **If you don't find exactly what you are looking for, please contact us for information on other suitable Parker products and to discuss your specific application requirements.**

# High Quality Automation Solutions

## We give machine builders and OEMs a competitive edge in many markets.

In motion control engineering and manufacturing, the Parker name stands for application expertise and high quality solutions. Our electromechanical systems and solutions are available wherever motion is needed—around the corner or around the world.



## It's Our Business to Help Your Business

A network of service centers and authorized distributors make project development and field support easy for customers. Five Parker electromechanical manufacturing locations in North America provide configured products, engineering capabilities, machining and assembly services, and factory-direct customer service support. Distributors are located across the United States, offering factory trained staff, local support, and other valuable services to address our customers' needs. The Parker Electromechanical Automation website offers the most extensive online support tools in the industry.

### Field Sales Network



Get technical expertise when you need it most, whether it's at the presales, project, or business account level. Engineering professionals make up a network of customer support, available in person to serve customer needs in their territories and are just a phone call away. The **Electromechanical Territory Manager** is the main point of contact for all customer relationship concerns like account management, education, and support. The **Business Development Manager**, **Strategic Account Manager**, and **Product Manager** all provide training and information in their focused markets. The **Electromechanical System Engineer** offers technical support pre- and post-sale at customer sites. And the **Application Engineer** is your trusted resource for sizing, selection, quoting, quantity and exception pricing, new applications development, and application support.

### Parker Nationwide Automation Technology Centers



An unrivalled network of local independent businesses brings Parker solutions, innovative products, and professional service to our customers. Field based engineers at thousands of locations worldwide are well trained to implement full system solutions, smooth the integration of complex applications, and increase compatibility between classes of products. You'll find professionals committed to improving operations for their customers. Take advantage of one of the most powerful industrial distribution networks in the industry while getting the support that Parker is known for.

### Parker on the Web



Parker's Electromechanical Automation website makes accessing information easy. Customers can research products, get brochures and catalogs, and find Parker locations. Read our blog for tech tips and industry trends and download innovative technology white papers. Build your project knowledge with interactive product sizing and selection tools, comprehensive CAD drawings, 3-D models for electronic and mechanical products, user guides, and detailed product specifications. See more at [www.parker.com/emn](http://www.parker.com/emn).

# Local Manufacturing for Fast Response, High Quality, and Tailor-Made Solutions.

Five locations in the US specialize in manufacturing linear actuators, gearboxes, motors, drives, controls, HMI, and structural aluminum extrusion. Because we manufacture domestically, we can easily tailor fit our solutions to your application needs via product modifications and custom manufacturing processes. Hundreds of local distributors round out our support network.

## Charlotte, NC - Drives Business Unit & Headquarters for Electromechanical and Drives Div.



Our Charlotte location is an industry leading manufacturer of AC variable speed drives, DC drives, and servo drives. These technologically advanced drives solutions and systems give peace of mind to our worldwide customer base through improved energy saving, increased productivity, and manufacturing efficiency. Charlotte has more than three decades of industry application assistance with OEM manufacturers and serves a variety of markets, such as industrial automation, hybrid/electric vehicles, pulp and paper, converting and energy.

## Irwin, PA - Mechanics Business Unit

For nearly 50 years, our Irwin location has been a leading supplier of electric actuators and manual positioners for industries and laboratories around the world. Applications like laser beam directing, fiber optics alignment, assembly fixturing, tooling, microscopy, camera focusing— even space flight—benefit from these products. The facility is ISO 9001: 2008 certified and focuses on Lean manufacturing to continuously improve our customers' experience.



## New Ulm, MN - Motor and Gearhead Business Unit



For 25 years, our New Ulm location has delivered high quality rotary servo motors, gearheads, and gearmotors. Standard products and core expertise support customer application development through the custom engineered solutions process. With a focus on providing a superior customer experience, the business unit has grown in industries such as automotive, aerospace, semiconductor, packaging, robotics, and more recently vehicle electrification. New Ulm has a strong foundation and is ISO 9001:2008 certified and AS 9001/TS16949 compliant.

## Wadsworth, OH - T-slot Aluminum Framing and Guarding

Our Wadsworth location focuses on providing solutions with an extensive offering of T-Slot aluminum framing products and mounting accessories, machine structure, and guarding systems. From workstations to enclosures to custom products, Parker's system of Selectable Levels of Integration provides unlimited options for our customers who require either a total system or individual components, all tailored to meet specific application requirements.



## Rohnert Park, CA - Electronics Business Unit



Since 1986, our Rohnert Park location has specialized in electronic motion control, including drives, controllers, human-machine interfaces, T-slot aluminum framing, and custom solutions. Configured for simple, fast, and easy integration, these best-of-breed individual components are available separately or as custom electronics and system solutions. The Electronic Business Unit is ISO 9001:2008 certified and focuses on continuously improving our customers' experience.

# Selectable Levels of Integration™

Selectable Levels of Integration™ is Parker's philosophy of product development and management. A machine builder can choose the appropriate system, subsystem, or component that meets their specific need.

Parker designs solutions for machine builders of all types, whether you need a complete integrated system or want to build your own with the tailored components that match your performance and price requirements.

From comprehensive systems to single products, we'll help you create the best solution for your business.

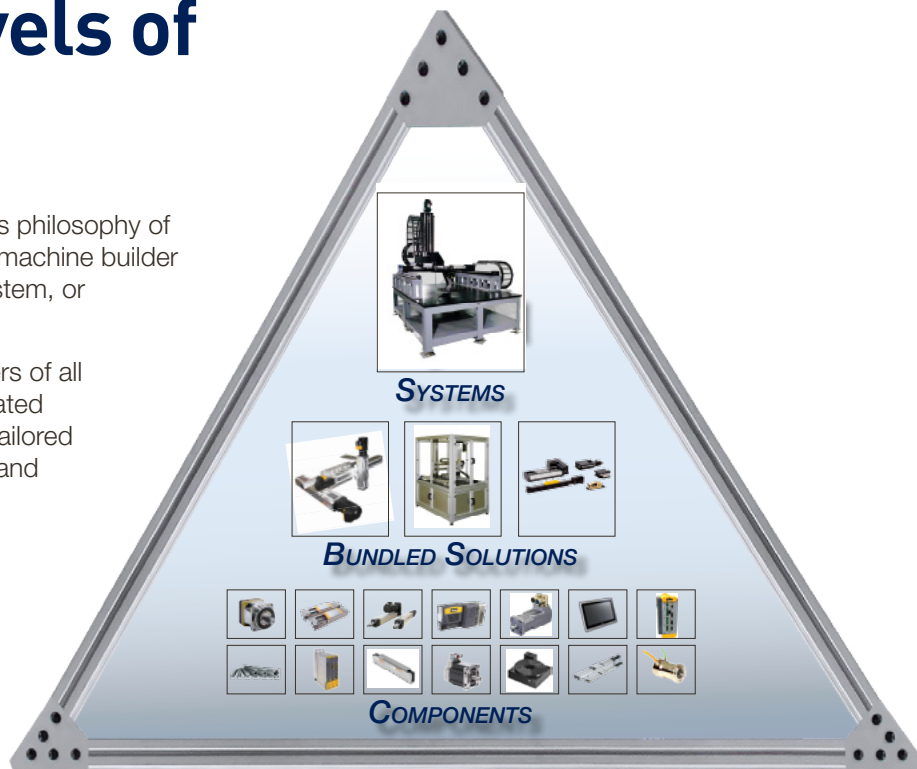

## Systems

Machine builders and OEMs often choose to integrate a complete electromechanical system into their existing machine. They rely on Parker's knowledge, experience, and support to make this process as simple and cost-effective as possible.

When you choose Parker as your design partner, our engineering expertise will reduce your design time, ensure components are compatible with each other, and bring your machine to life more quickly. Ultimately this results in savings of both time and money.

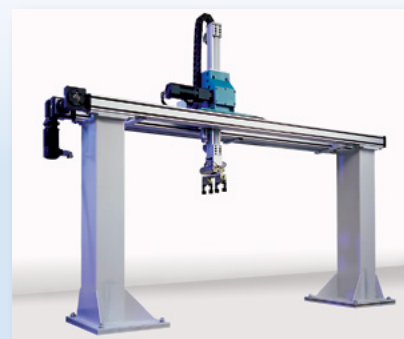
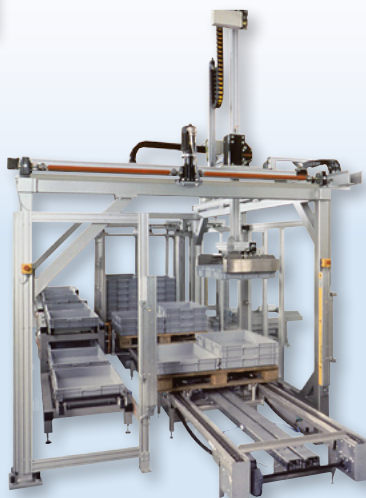
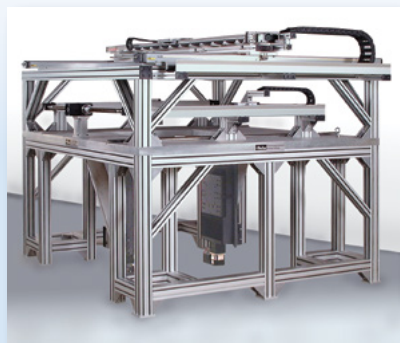







## Visualization – Human-Machine Interfaces (HMI)

Parker offers HMI solutions for every application, from simple push-button replacement to sophisticated networking, multimedia, and data logging requirements. Parker pre-loads Interact Xpress or InteractX HMI software on PowerStation industrial computers to provide a ready-to-go HMI solution. This bundled approach reduces development and integration time for your HMI project.



## Motion & Machine Controllers

Parker automation controllers have advanced features built-in, such as kinematics transformation for the control of robots and other non-linear functions. With a variety of communication protocol options, these controllers are easily adapted into your machine network and can help manage your internet data connectivity for machine to machine communications, with our embedded Xpress platform.



## Drives & Drive/Controllers

Parker servo and stepper drives are designed to deliver a maximum amount of power output and performance. With optional integrated control capability, Add On Instructions for EtherNet/IP, and multiple communication protocols, Parker drives are optimized to ease integration and start-up.



## Rotary & Linear Motors

Using advanced technologies, Parker rotary motors provide maximum torque density. Our designs also provide cog-free rotary motion for the best low-speed smoothness. Patented linear motor designs provide the greatest winding uniformity and accuracy in the industry, and our product offering scales from small linear motor components to the largest force capacity.



## Gearheads & Gearmotors

With expert machining and high precision designs, the Parker gearheads have precision options with less than three arc-minutes of backlash. Our other gearhead options include NEMA sizes, right angle, dual drive, and more.



## Linear & Rotary Positioners

Parker offers best-in-class positioner designs with screw, belt, or linear motor-drive technologies. Our award-winning designs lead the way with unmatched flexibility and precision capabilities. Parker's breadth of positioning product solutions includes positioners, miniatures, OEM-friendly linear motors, and precision and high-payload industrial rotary positioner products.

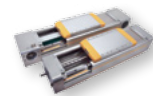

## Manually Driven Positioning Slides and Stages

For over forty years, Parker has been a leader in supplying manual positioners to industries and laboratories around the world. Free travel linear slides and precision positioners are available in sizes ranging from less than half an inch wide to 6 inches wide, travels from 1 inch to 30+ feet, and payload capacities of hundreds of pounds.



## Electric Cylinders

Since the early 1990s, Parker has led the market for high quality electric cylinders. Today, Parker has one of the most complete electric cylinder product lines available, offering high speed linear motor versions, high-force ball screw cylinders, extreme-force roller screw cylinders, and low- to medium-capacity lead screw/ball screw versions. Products range from ISO25 to 195 mm frame sizes with capabilities up to 80,000 lbs of thrust.

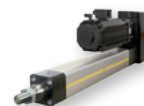

## T-Slot Aluminum Framing (IPS)

Parker T-Slot aluminum framing utilizes aircraft-grade aluminum for robust, high-strength assemblies. Choose from individual components, bundled inventory, kits, and turnkey systems. We also offer full engineering, fabrication, and assembly services. We are the single source/complete resource for all your structural design needs.



## Systems

Parker offers multi-axis Cartesian and gantry-style robots as standard pre-configured. If the application needs something more custom, we offer best-fit custom automation solutions ranging from precision cleanroom and laboratory motion to heavy-duty industrial automation. When you partner with Parker, you leverage the full extent of our global motion and control leadership to create unrivalled application solutions.



# Visualization & HMI

## Visualization & HMI Selection Guide

Product Families

SERIES	Page number	Display				Software				Features				System									
		No Display	7" Display (800 x 480 px)	10" Display (1280 x 800 px)	15" Display (1280 x 800 px)	17" Display (1024 x 768 px)	22" Display (1920 x 1080 px)	Interact Xpress	Interact X	Xpress Remote Manager	Drag-and-drop HMI Programming	Remote access via web browser	Support for 50+ device drivers	Recipe management	Unlimited tags	3rd party application support	VBA scripting	ActiveX controls	1.0 GHz AMD controls	1.86 GHz AMD Cortex	Android 4.1	Windows CE7	Windows ES7P
XT	11	•	•	•	•	•	•	•	•	•	•	•	•	•	•	•	•	•	•	•	•	•	•
IX	12	•	•	•	•	•	•	•	•	•	•	•	•	•	•	•	•	•	•	•	•	•	•
PC	13	•	•	•	•	•	•	•	•	•	•	•	•	•	•	•	•	•	•	•	•	•	•
PHM	13	•	•	•	•	•	•	•	•	•	•	•	•	•	•	•	•	•	•	•	•	•	•
PT*	18	•	•	•	•	•	•	•	•	•	•	•	•	•	•	•	•	•	•	•	•	•	•

\* Software features are derived from the PT displaying embedded Xpress running on the PAC. The PT hardware itself only runs Xpress Remote Manager.

## Human Machine Interface



The next generation has arrived! Create the new face of your machine using Parker's proven and intuitive HMI development software on powerful new hardware and gorgeous displays. The latest generation of Parker's HMIs—the XT, IX, PT, and PC—offer powerful flexibility in a modern form factor.

With the same look and feel, any of the XT, IX, and PC modules could

be interchanged in the same cut-out space. On the inside, these HMIs vary drastically, offering the right fit for any application.

The lightning-fast XT hardware provides a powerful boost to our award-winning, drag-and-drop HMI creation software, Xpress. For power users looking for more

control with data logging and VBA scripting, our InteractX software platform has moved to the new sleek IX series.

The PC option includes Windows Standard Embedded 7 enabling users to run 3<sup>rd</sup> party software or develop their own.

## XT – Xpress Terminal



[http://bit.ly/AT\\_XT](http://bit.ly/AT_XT)

The new Xpress Terminal (XT) takes the Xpress family of “information anywhere” to new heights in performance, flexibility, and reliability.

Handle communications to multiple PLCs/Devices with ease as the rich graphics, animations, and critical

data update faster than ever before. The impressive responsiveness of screen navigation, plus award-winning function, deliver an outstanding user experience.

- 7”, 10”, 15” and 22” touchscreen displays
- Headless option
- Slim 1.3” cabinet depth
- Fan-less and vent-less
- 4GB SD solid state storage
- 1.86GHz Quad Core, 4GB DDR
- 2 USB, 2 Serial, 2 LAN ports
- Intuitive Xpress software with powerful toolset
- 50+ bundled communications drivers
- Unlimited PLC/device connections
- Protocol conversion between connections
- Unlimited Tags, Screens, Alarms
- Vivid colors and rich graphics
- Secure Remote View/Control/Edit
- IP65 aluminum bezel
- Analog resistive & projected PCT for 21.5” option.

### PRO TIP

For users who want an HMI with the Parker Automation Controller's (PAC) embedded Xpress, see PAC Accessories for the PT Terminal!  
See page 18.

## XT Software: Interact Xpress



[http://bit.ly/AT\\_XP](http://bit.ly/AT_XP)

Interact Xpress™ simplifies HMI applications, reduces cost, and provides superior drag-and-drop graphics and unprecedented communication flexibility.

Access the Xpress Manager development environment from the HMI panel itself, any PC running a web browser, or via a local install of Xpress Manager. Xpress makes extensive use of web technology for cost effective support of machine

installations and remote stations around the world.

Xpress offers one package to design, publish, run, and support your HMI application, and includes 50+ drivers for 3<sup>rd</sup> party PLCs at no additional charge.

- Hardware/software integration optimizes performance, storage, and connectivity
- Rich, graphical runtime interface scales to various screen sizes
- Sophisticated graphics, animations, and video enhance the operator experience
- Built-in networking, web publishing, and browsing from any operator station
- Advanced security tools support single/multi-user applications, plus integrated development from operator interface
- Unlimited tags—no hidden costs
- Numerous device communication drivers included
- Affordable HMI for multi-site, multi-station and standalone machines, particularly when remote control, monitoring, and support are desirable
- Supervisory stations created by simply publishing the local HMI screens to supervisory software or web
- Sophisticated recipe management tools included
- Easy multi-language support multi-language

## Remote Manager for Interact Xpress HMI



The Parker Remote Manager empowers OEMs and users to remotely monitor and control factory automation displays from anywhere in the world.

Parker Remote Manager is an intuitive application available on any device for Apple® or Android™ that controls any Interact Xpress HMI.

- Provides a secure connection by requiring both the machine IP address and a user name and password
- Customize functionality with seven security levels to suit plant and IT environments
- Monitor plant metrics remotely
- Configure alarm notifications via text messages or e-mail for critical processes
- Run diagnostics on machines

Apple is a trademark of Apple Inc.  
Android is a trademark of Google Inc.



# Visualization – HMI

## IX – InteractX Terminal



[http://bit.ly/AT\\_IX](http://bit.ly/AT_IX)

The InteractX (IX) industrial-hardened powerstations provide big performance in a small package. The IX is the perfect platform for HMI only applications, offering the software

power, features, and flexibility normally reserved for SCADA level applications in a robust, cost-effective hardware platform.

The IX platform includes a Windows OS and the InteractX runtime with unlimited tags. The unique InteractX screen-scaling software allows applications with advanced graphics to be run on any size IX Powerstation.

- **7”, 10”, 15” and 22” touchscreen displays**
- **Headless option**
- **Slim 1.3” cabinet depth**
- **Fan-less and vent-less**
- **32GB SSD**
- **1.86GHz Quad Core, 4GB DDR**
- **2 USB, 2 Serial, 2 LAN ports**
- **Windows Standard Embedded 7**
- **Vivid colors and rich graphics**
- **Secure Remote View/Control/Edit**
- **IP65 aluminum bezel**
- **Analog resistive & projected PCT for 21.5” option**

## IX Software: InteractX™ Supervisory HMI



[http://bit.ly/AT\\_IXS](http://bit.ly/AT_IXS)

InteractX™ leads the industry with breakthrough HMI graphics and built-in connectivity. Now with version 4.0, InteractX leads the way in the supervisory HMI category by dramatically reducing application development time and integration cost for your manufacturing operations.

InteractX 4.0 provides powerful trending and analysis tools that aggregate data from multiple machines or work-cells, and easily pulls Interact Xpress™ machine level HMI screens and data directly into its interface—without having to recreate applications or input tags!

- **Hardware/software integration optimizes performance, storage, and connectivity**
- **Rich, graphical runtime interface that is scalable to various screen sizes**
- **Runs sophisticated graphics, animations, and video to enhance the operator experience**
- **Built-in networking, web publishing, and browsing from any operator station**
- **Advanced security tools support single and multi-user applications, as well as integrated development from operator interface**
- **Unlimited tags - no hidden costs**
- **Numerous device communication drivers included**
- **Full featured historical trending software**
- **Supervisory-level HMI aggregates data from multiple sources, including 3rd-party PLCs and HMI panels**
- **Time-saving “distributed HMI” integration with Interact Xpress**
- **Sophisticated recipe management tools included**
- **Preconfigured and custom Panel tool library for quick screen development**
- **Supports ActiveX controls for easy integration of 3<sup>rd</sup> party tools**
- **Includes Virtual Basic for applications (VBA) for easy customization**
- **Vast 3<sup>rd</sup> party OPC client/server support**
- **Easy multi-language support**
- **Compliance browser**



## PC – Panel PC Terminal



[http://bit.ly/AT\\_PC](http://bit.ly/AT_PC)

Parker’s latest industrial PC series, the PC, provides a rugged aluminum cast frame and fan-less package to run the most demanding Windows control and system applications.

The vesa and c-clamp mounts allow the PC to have the flexibility of dropping into any system, and with an impressive range of shock and vibration specs, the PC is ready for any environment.

The PC Industrial PowerStations are configured to run third-party or custom Windows applications and are also pre-loaded with our InteractX demo software.

- **7”, 10”, 15” and 22” touchscreen displays**
- **Headless option**

- **Slim 1.3” cabinet depth**
- **Fan-less and vent-less**
- **32GB SSD**
- **1.86GHz Quad Core, 4GB DDR**
- **3 USB, 2 Serial, 2 LAN ports**
- **Windows Standard Embedded 7**
- **Vivid colors and rich graphics**
- **Secure Remote View/Control/Edit**
- **IP65 aluminum bezel**
- **Analog resistive & projected PCT for 21.5” option**



## PHM Industrial Monitors



[http://bit.ly/AT\\_PHM](http://bit.ly/AT_PHM)

This family of industrially hardened monitors is perfect for harsh environments. They feature a chemical-resistive NEMA 4/4X front bezel and convenient clip mounting.

### Display Sizes

- **15” XGA (1024 x 768)**
- **17” SXGA (1280 x 1024)**
- **Analog resistive touchscreen**
- **On-screen display controls**

- **Auto power sensing and sleep mode**
- **Stainless steel bezel available on 15” models**
- **USB and serial interfaces for touchscreen**
- **VGA and DVI interfaces for video**
- **24 VDC power**
- **CE, UL and cUL agency approvals standard**
- **Class 1 Div. 2 available**



# Factory Displays



[http://bit.ly/AT\\_FD](http://bit.ly/AT_FD)

Whether presenting Andon displays, lean metrics, production status, OEE data, safety policies, or employee announcements, the headless series is far more than just a scoreboard.

Significantly reduce downtime and scrap by empowering workers with real-time, situational awareness that encourages faster responses

to downs and non-confirming conditions on the factory floor.

Connect any monitor, TV, or industrial screen using VGA and HDMI ports on the headless XT00, IX00, or PC00.

The XT00 runs Interact Xpress software, and 50+ drivers allow it to connect to multiple PLCs for automated data collection and display.

The IX00 is loaded with the powerful InteractX software with ODBC drivers allowing users to pull and display data from SQL,

Oracle, and Access databases.

The PC00 empowers users to create their own software applications to display on the floor.

- **Move information around or even off the plant floor**
- **Connect to any display with HDMI or VGA**
- **HD image quality**
- **Fan-less and vent-less**
- **1.86 GHz Quad Core, 4GB DDR**
- **2 USB, 2 Serial, 2 LAN ports**

# Motion & Machine Control

## Motion Controller Selection Guide

### Product Families

SERIES	Page number	Power		Control Methods				Features				Axes		Expansion I/O							
		120 - 240 VAC	24 VDC	EtherCAT	EtherNet POWERLINK	EtherNet/IP	± 10V Servo Control	Step and Direction	Additional Field Bus Options	IEC-61131-3	Acrobasic	Multi-axis Coordination	G-code	Embedded HMI Visualization	Multitasking	Windows API	2, 4, 6, or 8	16	16 +	PAC IO Modular System	P IO Modular System
PAC	15	•	•	•	•	•	•	•	•	•	•	•	•	•	•	•	•	•	•	•	•
ACR9600	19	•	•	•	•	•	•	•	•	•	•	•	•	•	•	•	•	•	•	•	•
ACR9630	19	•	•	•	•	•	•	•	•	•	•	•	•	•	•	•	•	•	•	•	•
ACR9640	19	•	•	•	•	•	•	•	•	•	•	•	•	•	•	•	•	•	•	•	•

## PAC Series Parker Automation Controller (PAC)



[http://bit.ly/AT\\_PAC](http://bit.ly/AT_PAC)

Powerful, integrated, and designed for the global machine market, the Parker Automation Controller (PAC) provides OEMs with a standards-based automation solution designed to tackle the most demanding applications.

The PAC consolidates advanced logic, multi-axis motion, signal handling, and web-published visualization into one

performance-driven solution. This eliminates the need for unnecessary hardware and communication links, and increases developer efficiency and cost savings.

The PAC employs the industry leading EtherCAT communication protocol for motion, I/O, and third-party device connectivity. Combined with the Parker Automation Manager IDE for

application development, the PAC provides OEMs with an engineered solution for the most demanding applications.

The PAC offers a single, intuitive environment for application development, industry standard programming, machine to-machine communication, network separation, and even Intellectual Property (IP) protection methods, among other features.

With the standard dual LAN capability for network separation, built-in OPC Client, Modbus TCP functionality, and the ability to integrate directly into EtherNet/IP and PROFINET networks, the PAC provides unprecedented

*Continued next page*



# Motion & Machine Control

## PAC Series Parker Automation Controller (PAC) *continued*

connectivity for complementary devices and network isolation for IT professionals.

The solid state design is precisely engineered for demanding industrial environments. The powerful, yet energy efficient Intel® Atom™ processor allows for fanless operation while supporting dual-cores, 64-bit instructions, and Hyperthreading technology.

Coupled with the removable, solid state SD storage media, all moving parts have been eliminated for a robust, industrial grade control solution.

### Hardware

- Intel Atom Dual-core, 1.60GHz, 64-bit
- 1GB DDR3 SDRAM
- Fan-less
- SD Application Memory
- Local & Remote I/O using PAC I/O
- DIN Rail Mounting

### Software

- IEC61131-3 Programming
- PLCopen Motion Control
- DIN 66025 CNC G-code
- Simulation Runtime Engine
- Web-configuration Tool
- Custom Libraries
- Extensible, Reusable Code

### Communications

- EtherCAT
- EtherNet/IP
- PROFINET
- Profibus
- OPC Server
- Modbus TCP
- Dual LANs



## PAC options for the right power and functionality

### C Option – Complex Multi-axis Coordinated and CNC Motion Libraries

The C-option is the most all-inclusive option and unlocks the full power of the PAC. These libraries include full CNC G-code textual and graphical editing. Import .dxf files to generate motion paths, create robots using the inverse kinematics libraries, or create custom profiles with our extensive coordinated multi-axis motion libraries.

Also includes all M and P Libraries.

### M Option – Basic Motion and Following Libraries

The M-option includes the libraries for point-to-point, jog, gearing, and CAM capabilities. This option makes basic and following motion even easier to program with a visual CAM manipulator and familiar PLCOpen functions. If users need any type of non-following coordinated motion between axes, they should upgrade to the "C" option.

Also includes all P libraries.

### P Option – PLC Only Libraries

For users who just need the basics, the P-option includes everything needed to handle the logic of the factory floor or of a complex machine. In conjunction with PAC I/O, the PLC option becomes the most flexible and easy to use remote and local I/O solution.



# PAC Software: Parker Automation Manager IDE

[http://bit.ly/AT\\_PAC](http://bit.ly/AT_PAC)

Smart and powerful, Parker Automation Manager (PAM) is the single integrated development environment (IDE) for programming complex logic, multi-axis motion, signal handling, and web published visualizations.

With PAM, engineers can leverage their existing knowledge to work smarter, more efficiently, and more effectively than ever with the full suite of IEC 61131-3 programming languages, PLCopen Motion Control, and G-code conforming to the DIN66025 standard.

This standards-based approach provides a common platform for control engineers and flattens the learning curve, thus saving OEMs time and money.

The common platform approach is complemented by a powerful simulation engineer for logic and motion that allows for faster development.

In addition it includes a complete suite of debugging tools, including powerful, inline variable forcing, watch, trending, system logging, and breakpoints for logic analysis.

PAM supports reusable, extensible software; object-oriented programming techniques; and even custom library creation for libraries that store the Intellectual Property (IP) of OEMs.

Engineers can now manage an entire machine family or product line in one project by including multiple hardware configurations and deploying the appropriate reusable software packages to specific application containers. This method allows OEMs to maintain their program files in one project and make code changes in one place to affect all versions of a particular machine. Thus machine builders now have a development platform specifically designed to support modular machines and valuable add-on software modules.

- **IEC61131-3 Programming**
  - Ladder Diagram
  - Structured Text
  - Continuous Function Chart
  - Function Block Diagram
  - Sequential Function Chart
  - Instruction List
- **PLCopen Motion Control I & II**
- **DIN 66025 G-code**



## Integrated Development Environment

- **Simulation Runtime**
- **Debugging**
  - Variable Forcing and/or Setting
  - Multiple Watch Windows
  - Trace
  - Powerflow
  - Breakpoints
- **System Logger**
- **Object-oriented Programming**
- **Custom Libraries and Function Blocks**
- **Customizable Interface**
- **Cam and G-code Editor**
- **Auto Declaration & Completion**
- **Recipe Manager**
- **Alarm Configuration**
- **Unit Conversions**
- **Web-published Visualization**
- **CNC Development**
- **DXF to G-code converter**
- **Function blocks for common robotic kinematics**
- **Edit motion pathways graphically and textually**

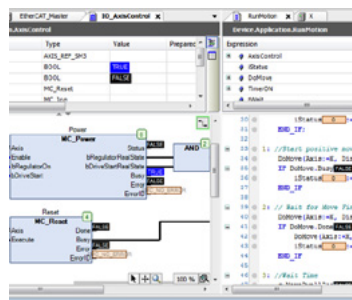

Programming

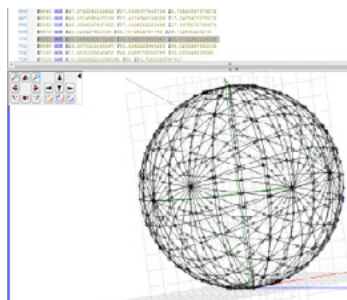

CNC Design

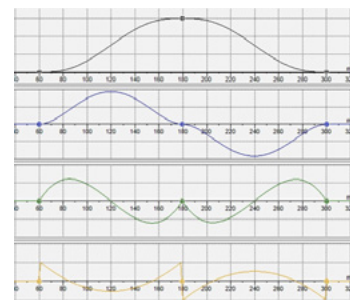

Graphical Cam Design

- HMI**  
Visualization
- MC**  
Machine Control
- DR**  
Drives
- MO**  
Motors
- GH**  
Gearheads
- P**  
Positioners
- MP**  
Manually Driven
- EC**  
Electric Cylinders
- IPS**  
T-Slot Framing
- S**  
Systems

# Motion & Machine Control

## PAC Accessories: PAC I/O



**EtherCAT**

A single module “stack” can include up to 20 modules. To add more or remote I/O, simply add an extender module at the PAC and bus extenders for any additional remote I/O stacks desired. The configuration possibilities are nearly limitless.

The PAC I/O System comprises a variety of modules for digital, analog, and temperature signals, and counters. The modules

connect directly to the controller via the built-in EtherCAT bus for local architectures and are extended to remote locations by extender and bus coupler modules, supporting both local and distributed I/O architectures.

PAC I/O modules feature a removable cage-clamp terminal design for easy wiring and assembly, which allows for the removal and insertion of modules without interfering with wiring; LED status indicators for the EtherCAT bus, I/O, power, and each signal channel; front-face shield-grounding to the din-rail; removable label inserts; easy access front mounted module disconnects; and laser-etched identification and schematic information.

PAC I/O communicates natively on the EtherCAT bus and is unencumbered by protocol converters, providing the full functionality and throughput of high-speed EtherCAT to meet the most demanding I/O requirements.



### + Remote IO

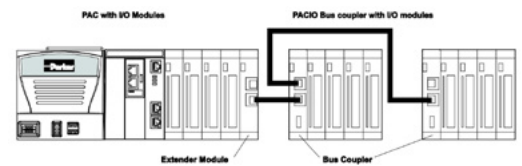

IP67 I/O coming soon.

[http://bit.ly/AT\\_PIO](http://bit.ly/AT_PIO)

## PAC Accessories: PT – PAC Terminal



The PAC Terminal (PT) reduces HMI hardware cost, development time, and downtime while also increasing security, performance, and system manageability. Designed to offer the easiest HMI configuration and connectivity in the industry, the PAC Terminal offers superior graphics and

performance. The Parker Automation Controller (PAC) hosts the Xpress Runtime or Web Visualization application and publishes it to the PAC Terminal’s web client, which allows for a rugged, industrially hardened hardware platform while reducing overall HMI cost.

- **Multiple display options to optimize your machine interface**
- **Reduce development time with the all-in-one development environment of Parker Automation Manager**
- **Reduce downtime with easy web visualization access from any device**
- **Reduce HMI costs with a centralized control solution**
- **Simplify installation with easy connectivity to third party through the PAC product**

# ACR Series Programmable Automation Controllers



[http://bit.ly/AT\\_ACR](http://bit.ly/AT_ACR)

ACR Series Controllers offer a powerful combination of motion and machine control in multiple hardware configurations.

Many industry standards, such as IEC61131-3 for programming and EtherNet/IP for communications, make the controller suitable for a wide array for users and applications.

Options for ETHERNET Powerlink and CANopen present flexibility to create numerous machine architectures.

## Motion and Programming Capabilities

- IEC61131-3 programming: structured text, ladder logic, and CFC
- Up to 16 PLC tasks: timer, cyclic, or interrupt configurable task priority
- Additional 16 AcroBasic tasks available

## PLCopen Function Blocks

- Absolute, incremental, and continuous moves
- Power, reset, and status
- Home, stop, and halt
- Axis parameter read and write

## Parker Function Blocks

- Electronic gearing
- Electronic cam
- Touchprobe
- Controller parameter read and write
- Linear interpolation
- Circular interpolation

## Hardware Features

- ETHERNET Powerlink digital motion bus
- EPL versions support up to 16 axes of coordinated motion
- Available support for traditional analog drives
- Analog versions are available in 2-, 4-, 6- or 8- axes models
- Equipped with 2MB of user memory standard
- Robust connectors hold up in harsh environments
- EtherNet/IP, CANopen, USB2.0, RS232 and RS485 communications are supported, with multiple channels available simultaneously
- CANopen I/O support for over 1000 points of I/O

**EtherNet/IP™**

ETHERNET   
**POWERLINK**  
Standardization Group

HMI  
Visualization

MC  
Machine Control

DR  
Drives

MO  
Motors

GH  
Gearheads

P  
Positioners

MP  
Manually Driven

EC  
Electric Cylinders

IPS  
T-Slot Framing

S  
Systems

# Drives & Drive/Controllers

## Drive and Controller Selection Guide

### Servo Product Families

SERIES	Page number	Input Power		Feedback				Controller Interface		Fieldbus Communications			Parker Motor Series												
		120/240 VAC	400 to 480 VAC	24 to 80 VDC	BISS-C	Incremental	Hiperface	EnDat	Sine-Cosine	Hiperface DSL	Resolver	±10V Analog	Step and Direction	Programmable EtherCAT	ETHERNET Powerlink	EtherNet/IP	PROFINET	P-Series	MPP	SM	BE	mSR	MX80	Linear	
IPA	21	•	•	•	•	•	•	•	•	•	•	•	•	•	•	•	•	•	•	•	•	•	•	•	•
Aries	21	•	•	•	•	•	•	•	•	•	•	•	•	•	•	•	•	•	•	•	•	•	•	•	•
P-Series	22	•	•	•	•	•	•	•	•	•	•	•	•	•	•	•	•	•	•	•	•	•	•	•	•
PSD	22	•	•	•	•	•	•	•	•	•	•	•	•	•	•	•	•	•	•	•	•	•	•	•	•
Compax3	23	•	•	•	•	•	•	•	•	•	•	•	•	•	•	•	•	•	•	•	•	•	•	•	•
Vix	23	•	•	•	•	•	•	•	•	•	•	•	•	•	•	•	•	•	•	•	•	•	•	•	•

### Stepper Product Families

SERIES	Page number	Input Power				Peak Current Output (Amps)				Control Version		Preferred Motor Series
		12VDC	24VDC	48VDC	80VDC	120VAC	2	3.5	4.8	8.0	Step and Direction	
E-AC	24	•	•	•	•	•	•	•	•	•	•	•
E-DC	24	•	•	•	•	•	•	•	•	•	•	•
P2	24	•	•	•	•	•	•	•	•	•	•	•
ZETA	25	•	•	•	•	•	•	•	•	•	•	•
ViX	25	•	•	•	•	•	•	•	•	•	•	•

# Servo Product Families

## Intelligent Parker Amplifier (IPA)



[http://bit.ly/AT\\_IPA](http://bit.ly/AT_IPA)

The Intelligent Parker Amplifier (IPA) is a versatile servo drive/controller with selectable functionality that gives the machine builder the flexibility needed to create cost-effective motion control solutions.

The IPA operates as a fully programmable stand-alone motion controller with on-board I/O and virtual axis capability, or can be integrated into a PLC or PC-based machine control solution. Software tools are included to optimize motion performance and efficiently monitor and manage the application. EtherNet/IP gives IPA users a popular connectivity option to PLCs for easy integration of servo motion in larger machine control application.

**EtherNet/IP™**

- **Ethernet TCP/IP communications**
- **Libraries for PC application development**
- **1½ axis encoder input for camming, following, and gearing**
- **Up to 16 multi-tasking programs**
- **EtherNet/IP adapter supporting both I/O and Explicit Messaging**
- **Add-On Instructions for integration with Logix controllers**

## Aries Series



[http://bit.ly/AT\\_A](http://bit.ly/AT_A)

The Aries Series are compact, easy-to-use servo motor drives. Aries is a cost-effective and flexible digital servo solution where users pay only for the performance they need. Select analog torque or velocity, step and direction, or ETHERNET Powerlink versions.

- **120/240 VAC input**
- **100 to 2000 W power levels**
- **Supported feedback devices include quadrature encoder and EnDat absolute encoder**
- **Rotary or linear servo motor control**
- **CE (EMC & LVD), UL recognized**

HMI  
Visualization

MC  
Machine  
Control

DR  
Drives

MO  
Motors

GH  
Gearheads

P  
Positioners

MP  
Manually  
Driven

EC  
Electric  
Cylinders

IPS  
T-slot  
Framing

S  
Systems

# Drives & Drive/Controllers

## Parker Servo Drive PSD



The Parker Servo Drive (PSD) family combines the latest in high performance servo technology with features that provide unique value to OEMs and machine builders. The PSD is a fieldbus network drive, with EtherCAT as the standard option. Hiperface DSL feedback<sup>®</sup> greatly reduces complexity with only one cable connection between drive and motor.

All PSD versions are equipped with Auto-tuning, Observer Technology, Anti Resonance Adjustments, Vibration Suppression, and Notch-filters for optimal servo performance. The drives are available in two form

factors: the standalone PSD1-S and the multi-axis PSD1-M. The PSD1-M is the most compact multi-axis servo system on the market and is available with modules as one, two or three axis versions.

The system configuration consists of a common DC bus supply and multiples PSD1-M modules, connected through DC bus bars. This makes the system highly flexible. PSD1-M servo system is particularly suitable for all centralized automation systems, such as those found in many packaging machines, where large numbers of drives are often required offering significant advantages.

### PSD1-S

- 230VAC single and three-phase power input
- 2A to 5A continuous current output

### PSD1-M

- 230-480VAC three-phase power input
  - 2A to 16A continuous current output
  - EtherCAT for high-speed communications
  - Ethernet TCP/IP communications for convenient set-up
  - Removable SD card
  - 4 digital inputs / 2 outputs per axis
  - Safe Torque Off
  - Optional Functional Safety over EtherCAT\* (FSOE)
  - Fieldbus Options : EtherCAT (standard) / PROFINET\* (optional) / EtherNet/IP\* (optional)
  - CE + UL/cUL Listed
- \* in development*

## P Series



[http://bit.ly/AT\\_PD](http://bit.ly/AT_PD)

The P-Series drives operate with a variety of machine control architectures and offer sophisticated servo functionality. A number of different feedback types are supported to drive a wide range of linear and rotary servo motors. The best matches are the P-Series motors, which include absolute encoders and populate motor nameplate data back to the drives for simplified commissioning.

Accurate and easy to use inertia detection leads to fast set-up of tuning parameters and minimal settling time. For high speed, real-time network applications, the P-Series is available with, EtherCAT, the fastest growing, most flexible industrial Ethernet protocol. Ideal for use with the Parker Automation Controller, the P-Series also follows the open standards for EtherCAT.

The Pulse version can be configured for step and direction control input and includes analog inputs for torque or velocity control. Select Indexer mode to create up to 64 position table entries triggered via inputs or over a RS422 interface.

- EtherCAT for high-speed motion bus
- Step/Direction and  $\pm 10V$  velocity/torque

- Indexer mode for preset positioning
- USB communications for convenient set-up
- 400 to 3.5kW power output
- BiSS-C and EnDat2.2 absolute feedback
- Quadrature encoder and 1vpp SineCosine
- 120/240VAC single and three-phase power input
- Configurable Dynamic Braking response
- 16 digital inputs/ 8 outputs, 2 analog in/out with pulse/indexer models
- 8 inputs/ 4 outputs with EtherCAT models
- Safe Torque Off (EtherCAT models)
- CE (EMC & LVD) and UL listed

# Compax3 Servo Drives & Drive/Controllers



[http://bit.ly/AT\\_C3](http://bit.ly/AT_C3)

With its high performance and modular design, the Compax3 family of industrial servo drives and drive/controllers offers the highest level of system design flexibility.

Enhanced by the IEC 61131-3 programming environment, the modular structure of the Compax3

family allows options such as intelligent motion controllers, fieldbus interfaces and industry standard motor feedback.

Available in single- or multi-axis configurations with numerous expansion options, all models are rated for 120 – 480 VAC input, continuous current output from 2.5 A (rms) to 155 A (rms), and are CE (EMC & LVD) and UL compliant.

## Compax3 Drive

- **5V/24V step/direction and ±10V analog command**
- **Resolver, encoder or high-resolution SinCos® Hiperface™ and EnDat 2.2**
- **Torque, velocity, or position control modes**
- **Encoder tracking capability**



## Compax3 Drive/Controller

- **Available as:**
  - servo positioning
  - programmable positioning with function modules according to PLCopen
  - advanced programmable positioning with electronic camming, gearing, etc.
- **Certified safety technology integrated into drive (EN954-1 Category 3)**
- **Fieldbus options: DeviceNet, Profibus, CANopen, ETHERNET Powerlink, EtherCAT, and RS232**
- **Supports all five IEC 61131-3 programming languages and continuous flow chart**
- **Resolver, encoder, or high-resolution Sin/Cos®, Hiperface™, Endat 2.2 and SSI feedback devices**

# ViX Servo Drives & Drive/Controllers



[http://bit.ly/AT\\_VIX](http://bit.ly/AT_VIX)

The ViX Series is flexible, powerful and compact, giving users a robust and cost-effective DC product, particularly in multi-axis applications. Designed for easy set-up and tuning, the ViX can be fully configured and running within minutes of unpacking the unit.

## ViX Drive

- **24 to 80 VDC input**
- **2.5 and 5 A RMS continuous versions available**
- **Torque, velocity, or position control**
- **Resolver or encoder feedback (software selectable)**
- **High-resolution encoder feedback option**
- **Five digital inputs and three digital outputs**
- **CE (EMC and LVD) and UL compliant**
- **RS232 or RS485 fieldbus**

## ViX Drive/Controller

- **Storage of up to 16 sequences**
- **Encoder following, registration, feed-rate override**
- **5 digital inputs, 3 digital outputs, 1 analog input**
- **Conditional statements**
- **Resolver or encoder feedback**

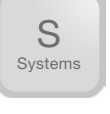

# Drives & Drive/Controllers

## Stepper Product Families

### E-AC and E-DC Microstepping Drives



The E Series is a high-performing, low-cost family of packaged AC-input and DC-input microstepping drives.

- **Anti-resonance circuitry suppresses mid-range instability**
- **Recommended motor inductance range of 0.5 mH to 80 mH**
- **Selectable resolution up to 50,800 steps/rev**
- **Auto standby reduces motor current (and heating)**
- **Current waveforms to optimize smoothness**
- **Optically isolated step and direction inputs**
- **Short-circuit and over-temperature protection**

### P2 Microstepping Drives



[http://bit.ly/AT\\_P2](http://bit.ly/AT_P2)

The P2 stepper drive is an OEM-friendly miniature motion drive capable of up to 2 Amps in a 1" x 1" x 3.3" square package.

- **Adjustable run current via potentiometer**
- **Auto standby adjustable current to reduce heat generation and power consumption**
- **Stepper resolution to 3200 steps/rev**
- **RoHS compliant**
- **DIN rail mountable or mounts directly to LCR Series linear positioners**
- **Accepts single or differential step and direction inputs**



# ZETA Microstepping Drives & Drive/Controllers



[http://bit.ly/AT\\_Z](http://bit.ly/AT_Z)

ZETA microstepping drives are standalone, packaged microstepping drives & drive/controllers that incorporate breakthrough techniques known as Active Damping™ and Electronic Viscosity™. The ZETA family of drives comes in two power versions: ZETA4 and ZETA8.

Designed for reliability, the ZETA drive family offers premier quality and performance while being easy to use and apply. The ZETA drive family meets the need for global solutions.

- **UL recognized**
- **120 VAC input**
- **DIP-switch selectable**
- **Resolution from 200 to 50,800**
- **Controller version provides 16 inputs/8 outputs**

# ViX Microstepping Drives & Drive/Controllers



[http://bit.ly/AT\\_VIX](http://bit.ly/AT_VIX)

The ViX Series is a digital, compact and high-power family of DC-input microstepping drives.

- **Wizard-based configuration**
- **Anti-resonance circuitry suppresses mid-range instability**
- **Recommended motor inductance range of 0.5 mH to 20 mH**

- **24 to 80 VDC bus input voltage**
- **Integer-selectable resolution from 200 to 51,200 steps/rev**
- **Five digital inputs and three digital outputs**
- **One analog input**
- **Controller version provides basic control functionality**
- **RS232 or RS485 fieldbus**

HMI  
Visualization

MC  
Machine  
Control

DR  
Drives

MO  
Motors

GH  
Gearheads

P  
Positioners

MP  
Manually  
Driven

EC  
Electric  
Cylinders

IPS  
T-slot  
Framing

S  
Systems

# Rotary & Linear Motors

## Rotary & Linear Motor Selection Guide

### Rotary Servo Motors

SERIES	Page number	Max Continuous Torque Nm (in-lb)	Max Speed (rpm)	Frame Sizes	Feedback	Application Advantages																						
MPP/MPJ	28	1.2 (10.6)	3.0 (28.0)	4.9 (43.4)	25.7 (227.0)	158.0 (1398.0)	5,000	7,500	NEMA 16	NEMA 23	NEMA 34	40 mm	60 mm	80 mm	7 sizes, 92 to 270 mm	3 sizes, 92 to 142mm	Incremental	Hiperface	EnDat	Sine-Cosine	Hiperface DSL	Resolver	BiSS-C	No cogging	High inertia	High acceleration	IP69K washdown	
MPW	28																											
P Series	29																											
SM	29																											
BE	30																											

### Specialty Rotary Servo Motors

SERIES	Page number	Max Continuous Torque Nm (in-lb)	Max Speed (rpm)	Frame Sizes	Feedback	Application Advantages																						
K	30	35.0 (311.0)	58.4 (516.4)	1080.0 (9558.8)	21000.0 (187110.0)	510	4,000	50,000	10 sizes, 32 to 254 mm	4 sizes, 92 to 145 mm	6 sizes, 85 to 310 mm	3 sizes, 360 to 762 mm	Hall sensors	Customer supplied	Resolver	EnDat	Very high system stiffness	High acceleration	Suitable for explosive environments	Direct integration into machine	High speeds	Constant power	Direct drive	Low speed	High torque			
EX	31																											
HW/HKW	31																											
TMW/TMA	32																											

### Rotary Stepper Motors

SERIES	Page number	Max Static Torque Nm (in-lb)	Max Speed (rpm)	NEMA Frame Sizes	Feed-back	Application Advantages	Drive Family													
LV	32	4.6	9.07 (1285.0)	3,000	5,000	11	14	17	23	34	Encoder Optional	< 48 VDC	< 80 VDC	120 VAC	E-DC	P2	Vix	E-AC	ZETA	
HV	32																			
ES	33																			

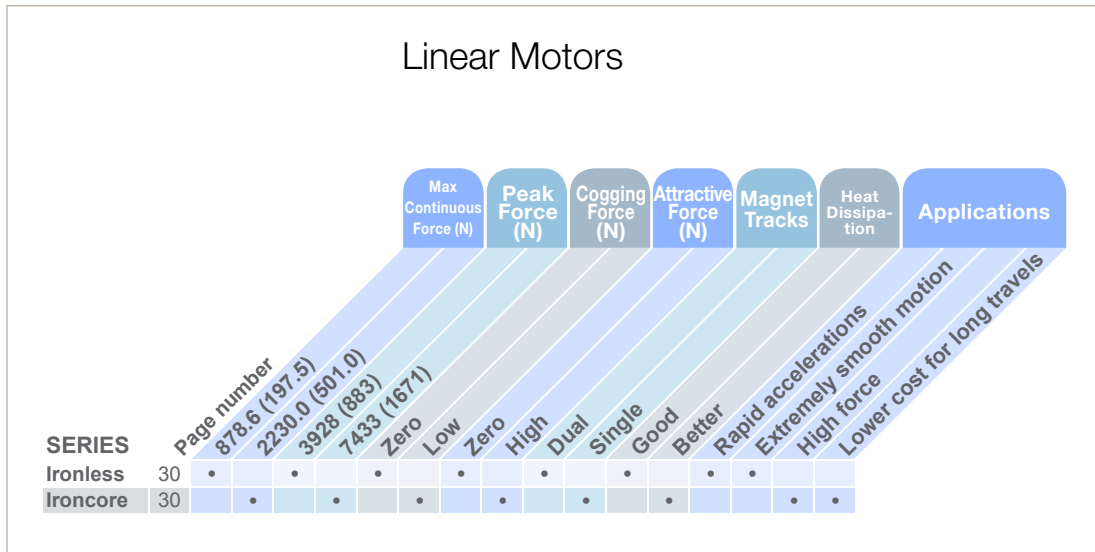

HMI  
Visualization

MC  
Machine Control

DR  
Drives

MO  
Motors

GH  
Gearheads

P  
Positioners

MP  
Manually Driven

EC  
Electric Cylinders

IPS  
T-slot Framing

S  
Systems

## Modified and Custom Motor Resources

Parker's standard shaft, feedback, and connection motor options meet the needs of most customers. However, we also engineer custom designs for customers whose applications require unique connectors, mountings, or windings.

Purchasing a custom motor from Parker is cost-effective, in part because we don't require you to order minimum quantities of your design. Plus, we offer short lead times for custom design services. Whether you buy a standard or custom motor, you can count on Parker to provide the best servo motor solution.

### Other Modification Services

- Private labeling
- Special paints/coatings
- Special windings
- Shorter lengths
- High-speed balancing

[http://bit.ly/AT\\_CMR](http://bit.ly/AT_CMR)

### Connectors

- MS connectors
- Right-angle rotatable
- MS connectors on back cover
- Special cable lengths
- High-flex cables
- Custom cables and connectors
- Cable exiting through rear cover

### Flanges

- Tapped mounting holes
- NEMA flanges
- Face mount
- Customer-specified flanges

### Gearheads

- Custom ratios
- Customer-specified flanges
- Customer-specified output shaft

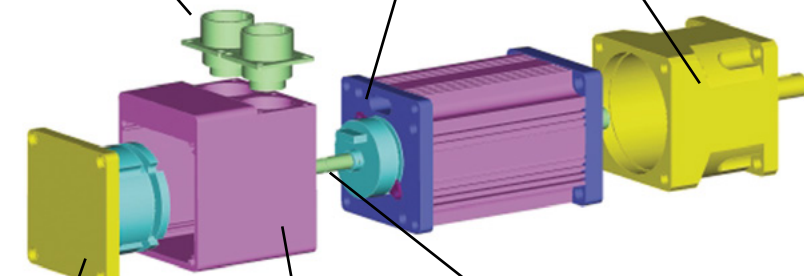

### Brakes

- Spring released
- Permanent magnet
- 24 and 90 volt brakes

### Feedback

- Incremental and smart encoders
- Absolute encoders — single- and multi-turn
- Resolver
- Custom feedback devices

### Shafts

- Special lengths
- Special flats
- Special keyways
- Special shaft diameters
- Hollow shafts
- Rear shaft extension
- Double flats
- Shaft pinning
- Pressed-on gears
- Center tapped
- Special shaft materials

# Rotary & Linear Motors

## MPP/MPJ Series Rotary Servo Motors

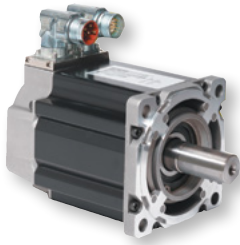

[http://bit.ly/AT\\_MPP](http://bit.ly/AT_MPP)

The MaxPlusPlus (MPP) family of brushless servo motors is redefining performance, flexibility, and reliability. The industry's highest-performing servo motor uses eight-pole segmented lamination technology, which produces more torque in a shorter package.

Use MaxPlusPlus motors for higher torque applications, customization options, or when high performance is required.

When higher inertia is desired to improve system performance, the MPJ is the perfect choice. It includes all the same features and benefits of the MPP, but increases the rotor inertia by 3 to 8 times over the standard MPP.

- **MPP: 92 to 270 mm frame sizes**
- **MPJ: 92 to 142 mm frame sizes**
- **1.5 to 158 Nm (13 to 1398 in-lb) continuous stall torque**
- **4.3 to 402 Nm (38.1 to 3558 in-lb) peak torque**
- **Very high torque-to-inertia ratio**
- **Right-angle rotatable connectors**
- **Eight different feedback devices including encoder, serial encoder, resolver, Hiperface DSL, Heidenhain and Stegmann single and multi-turn absolute encoders**
- **IP64 standard, IP65 optional**
- **Special shaft, front flange, and feedback devices available**
- **CE and UL**

## MPW Series Stainless Steel Servo Motors Series

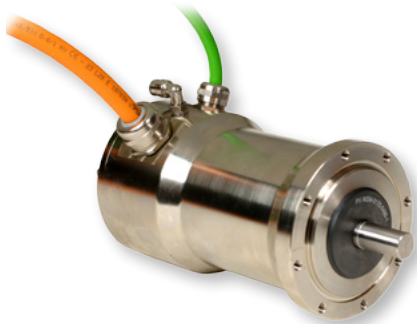

[http://bit.ly/AT\\_MPW](http://bit.ly/AT_MPW)



**IP69K**  
certified

The new MPW Series extends the MPP motor family to meet the needs of those applications exposed to high pressure, highly caustic, washdown environments. Specific applications can be found in such markets as Food and Beverage, Pharmaceutical, Packaging, and any other application that may be exposed to harsh conditions like salt, fog, and humidity.

The NSF mark represents Parker's company wide commitment to quality, safety, and compliance with The Public Health and Safety Organization standard requirements for safe food handling.

- **10 models covering three frame sizes**
- **Sealed to IP69K for 1200 psi washdown requirements**
- **Potted stator design for improved thermal efficiency**
- **35 to 227 in-lbs continuous torque (230 and 460 VAC supply)**
- **Options include high resolution encoders, resolvers, and 24 V brake**
- **Cable options available to plug and play with a wide variety of drives**
- **Complies with all NSF standard 169**

## P Series Motors



[http://bit.ly/AT\\_PD](http://bit.ly/AT_PD)

The P Series brushless servo motors are the perfect match with P Series drives, providing high torque and fast settling times with one-touch tuning.

All motors include high resolution BiSS-C absolute encoders that populate motor nameplate data back to the drives for simplified commissioning. Economical, low profile cable connections help machine builders meet demanding size and budget requirements.

- 40, 60, 80 mm frame sizes
- 0.2 to 3 Nm (2 to 28 in-lb) continuous stall torque

- 0.5 to 10 Nm (4 to 85 in-lb) peak torque
- Allowable load inertia up to 30 x rotor
- BiSS-C absolute feedback, up to 524288ppr
- Performance matched with P drives
- 3000 rpm rated, 5000 rpm max speed
- Low-profile cable connections
- Static brakes available
- IP67 rated (body and connectors)
- CE (EMC & LVD) and UL (pending)

## SM Series Servo Motors



[http://bit.ly/AT\\_SM](http://bit.ly/AT_SM)

The SM Series brushless servo motors feature a slotless stator design eliminating all detent torque in the motor to provide extremely smooth motion, especially at low speeds.

The slotless design also creates a higher rotor inertia, which is ideal for applications involving high inertial loads (such as lead screws and belt drives). This higher rotor inertia simplifies tuning and increases system stiffness.

The SM Series motors also feature a rugged anodized aluminum body and connector housing. An IP65 rating can be obtained on motors with PS connectors and an optional shaft seal. All SM motors are CE (LVD) compliant.

Parker's wide range of planetary gearheads are well-suited for the SM Series motor. Easy sizing and selection can be done using Parker's Motion Sizer.

- NEMA size 16 and 23
- 0.19 to 1.2 Nm (1.7 to 10.6 in-lb) continuous stall torque
- 0.57 to 3.6 Nm (5.0 to 31.9 in-lb) peak torque
- Up to 7500 RPM rated speed
- Brushless construction
- Slotless design
  - Negligible detent torque
  - Reduced torque ripple
  - High inertia
- High-performance neodymium magnets
- Thermostat protected
- TENV housing
- IP65 option
- Feedback options
  - Encoder/Hall effect
  - Resolver
- CE compliant

HMI  
Visualization

MC  
Machine  
Control

DR  
Drives

MO  
Motors

GH  
Gearheads

P  
Positioners

MP  
Manually  
Driven

EC  
Electric  
Cylinders

IPS  
T-slot  
Framing

S  
Systems

# Rotary & Linear Motors

## BE Series Servo Motors



[http://bit.ly/AT\\_BE](http://bit.ly/AT_BE)

BE Series brushless servo motors produce high continuous stall torque in a cost-reduced package.

The exceptional torque of the BE Series motors is the result of an increased number of magnetic poles on the rotor.

Traditional motors in these frame sizes have four magnetic poles, while the BE Series motors have eight poles.

The BE motors incorporate Parker's proven bridged stator design. This two-piece lamination design simplifies the winding process, creating cost savings. The bridged stator construction also results in less audible noise generated by the motor.

Parker's wide range of planetary gearheads is well suited for the BE Series motor. Easy sizing and selection can be done using Parker's Motion Sizer.

- **NEMA 16, 23, and 34 sizes**
- **0.15 to 4.9 Nm (1.3 to 43.4 in-lb) continuous stall torque**
- **0.45 to 14.6 Nm (4.0 to 129.2 in-lb) peak torque**
- **Up to 5000 rpm rated speed**
- **Brushless construction**
- **Eight-pole open-lamination design provides increased torque and lower cost**
- **High torque density packaging**
- **Bridged stator design—quiet operation**
- **High-performance neodymium magnets**
- **Thermoswitch protection**
- **Feedback options**
  - Encoder/Hall effect
  - Resolver
- **CE compliant**

## K Series Frameless Kit Motors



[http://bit.ly/AT\\_K](http://bit.ly/AT_K)

Frameless kit motors are the ideal solution for machine designs that require high performance in small spaces. Kit motors are directly integrated with the drive train, resulting in a smaller, more reliable motor package. Direct drive motion construction also gives equipment designers the advantages of lower costs, increased reliability, and improved performance.

### Best Used for:

- **A significant cost savings**
- **Reduced mechanical complexity**
- **Greater design flexibility**
- **High performance in a compact package**
- **Improved dynamic response and settling**
- **Minimum motor size per application space**
- **Low cogging for smooth operation**
- **Low inertia for high acceleration**

### Features

- **High peak torque up to 93.37 Nm (826.4 in-lb)**
- **High speeds up to 50,000 rpm**
- **Superior performance – high stiffness and better response**
- **High reliability—no mechanical couplings**
- **Compact design—minimizes product size**
- **Low cogging—special orientation of the laminations and odd slot count**
- **Very low torque ripple at low speeds for smooth and precise rotary motion**

## EX Series Explosion Proof Servo Motors

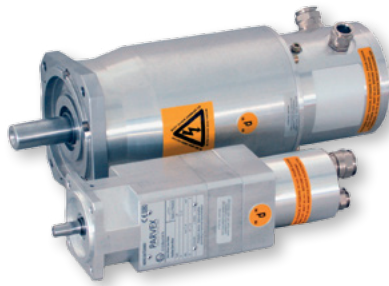

The EX Servo motors are designed to function in Category II, Group II explosive atmospheres in respect to the EN 50014 standard. These servo motors are certified according to directive ATEX 94/9/CE and are available in a Gas or Gas-Dust version. The motors differ in that the Gas-Dust version is equipped with a special lip seal on the customer end shaft.

- **Explosion-proof material “D” according to directive ATEX 94/9/CE**
- **Stall torque from 1.75 to 35 Nm (15.5 to 311 in-lb)**
- **Rated speeds up to 4000 rpm**
- **Extremely compact**
- **High dynamics**
- **Integrated resolver does not require an additional encoder**
- **Maintenance-free, lubricated-for-life bearings**

## HW/HKW Series Synchronous Water Cooled Spindle Motors



The HW servomotors are water-cooled brushless synchronous motors delivered as individual components (rotor, stator and resolver) to make a complete spindle unit. These motors are driven by Compax3 Series servo drives.

- **Permanent magnet cold rotor**
- **Compact size with low rotor inertia**
- **Stable balancing**
- **Speed range to 50,000 rpm**
- **Reduced maintenance**
- **High torque at zero speed**
- **Positioning capability**

## GVM Series for Vehicle Electrification



The GVM (Global Vehicle Motor) is Parker’s PMAC offering for electric and hybrid electric powertrain motors, and electro-hydraulic actuation.

The GVM’s highly engineered magnetics achieve efficiencies in peak regions not obtainable

in other designs. The GVM uses a new patent-pending advanced cooling system that has minimal impact on the size and weight of the motor.

The scalability and customization of the GVM allows the widest performance range available. Tested to the demanding heavy duty vehicle grade standards of SAE J1455, the GVM can handle the toughest job for any on or off-road vehicle.

- **Multiple frame sizes, stack lengths, and windings**
- **Peak power density up to 4.2 kW/kg**
- **Continuous power density up to 2.3 kW/kg**

- **24–800 VDC operating voltages**
- **Samarium Cobalt (SmCo) magnets allow high temperature operation and remove demagnetization failure mode**
- **Highly efficient design reduces thermal dissipation requirements, lowering overall cooling system costs**
- **Very low torque ripple—even at peak current**
- **Low rotor inertia for high dynamic responsiveness**
- **Up to 20% more range for a given battery pack**
- **Ultra-thin stator laminations with reduced slots virtually eliminates eddy currents**

HMI  
Visualization

MC  
Machine  
Control

DR  
Drives

MO  
Motors

GH  
Gearheads

P  
Positioners

MP  
Manually  
Driven

EC  
Electric  
Cylinders

IPS  
T-slot  
Framing

S  
Systems

# Rotary & Linear Motors

## TMW/TMA Series Torque Motors



The torque motor is a permanent magnet brushless motor, optimized to operate at low speeds. It is particularly suitable for direct drive applications requiring high torque capabilities at low speeds.

As a replacement for asynchronous or direct current motors coupled with a gearbox, torque motors are advantageous with their more compact, quieter, maintenance-free design.

- No more gearbox
- No maintenance
- Energy savings
- Silent operation (European directive 2003/20/Ce)
- Better speed regulation
- Compact design
- Stall torque from 391 to 21,000 Nm (289 to 15,540 ft-lb)
- Rated speeds up to 800 RPM
- TMA Series air cooled, without fan; TMW Series water cooled with anticorrosive
- IP55 rating
- Sincos Hiperface, EnDat feedback

## LV/HV Series Rotary Stepper Motors



[http://bit.ly/AT\\_HV](http://bit.ly/AT_HV)

The LV (Low Voltage) and HV (High Voltage) motor series provide outstanding performance at a competitive price. The LV motors are available in five frame sizes, and the HV are available

in three frame sizes, so it is easy to choose the optimal speed and torque combination.

The LV motors are rated for use with drives running up to 80 VDC; the HV are rated for use with drives running off of 120 VAC power.

The LV/HV Series is optimized for use with the E-Series microstepping drives.

- High performance
- Cost effective
- Optimized motors for both low-voltage and high-voltage applications

- Static torques from 6.5 to 1285 in-oz)
- LV: 11, 14, 17, 23, and 34 frame sizes  
HV: 17, 23, and 34 frame sizes
- Single, double, or triple stack lengths available
- LV: up to 80 VDC windings  
HV: up to 170 VDC windings
- Single or double shaft options
- Flying leads or 10-foot cable options
- Customization available
- Encoder options available
- CE (LVD)



## ES Series Stepper Motors



The ES motor series allows you to take Parker's existing stepper technology to an even higher level of performance. Choose this motor when extra smooth motion is essential.

ES Series motors are designed to allow you to easily change the motor winding configuration.

Different performance levels can be obtained by connecting the step motor windings in series or parallel.

- **Quality motors that give a smoother velocity performance.**
- **23 and 34-frame.**
- **S106 motors are 42-frame.**

## RIPPED Ironcore Linear Motors

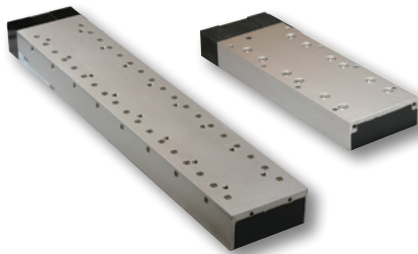

[http://bit.ly/AT\\_RIP](http://bit.ly/AT_RIP)

Parker RIPPED ironcore linear motors, with their patented anti-cog technology, can produce the large forces needed for many industrial applications—without the roughness associated with traditional ironcore linear motors.

The RIPPED family is well suited for a broad range of extremely demanding applications.

- **Patented anti-cog technology for extremely smooth motion**
- **3 different cross sections**
- **Single magnet row for high performance at an economical price**
- **Connector module allows for quick installation and easy cable management**
- **Ultra high-flex cable standard**

HMI  
Visualization

MC  
Machine  
Control

DR  
Drives

MO  
Motors

GH  
Gearheads

P  
Positioners

MP  
Manually  
Driven

EC  
Electric  
Cylinders

IPS  
T-slot  
Framing

S  
Systems

# Rotary & Linear Motors

## I-Force Ironless Linear Motors



[http://bit.ly/AT\\_IM](http://bit.ly/AT_IM)

Parker I-Force ironless motors offer high force and rapid accelerations in a compact package. Parker's patented I-beam shape, with its overlapping windings, allows for a higher power density in a smaller motor, improved heat removal, and added structural stiffness. A forgiving air gap and no attractive forces allow for easy installation and zero cogging during motion.

- **5 different cross sections (110, 210, 310, and 410) with up to 8 poles**
- **Compact size with high force density and superior heat removal**
- **Air and water cooling**
- **Vacuum rated to  $10^{-6}$  torr**
- **Ultra high-flex cable standard**

## ML18 I-Force Ironless Linear Motor



[http://bit.ly/AT\\_ML](http://bit.ly/AT_ML)

Introducing the newest (and smallest) member of Parker's I-Force ironless linear motor family. The ML18 incorporates the I-Force I-beam shape with overlapping windings allowing for high power density, improved heat removal, and added structural stiffness.

- **Height of 35mm, width of 18mm offers a compact solution**
- **Three coil lengths provide peak force up to 50N**
- **Ironless design produces zero cogging**
- **Light weight allows for rapid accelerations**
- **Innovative magnet track provides a low cost solution**



# Gearheads & Gearmotors

## MultiDrive Gearheads



Stealth® MultiDrive offers three different output options for true flexibility:

**RB Series low ratio**  
**RD Series double shaft**  
**RT Series hollow shaft**

All models are configured in a compact, right-angle package. MultiDrive gearheads feature Stealth® helical gearing for high torque, high accuracy and quiet operation.

With five frame sizes and multiple ratios to choose from, you are sure to find a Stealth® MultiDrive to fit your servo motor application.

- Frame sizes from 90 to 180 mm
- Continuous torque from 23 to 260 Nm (204 to 2,300 in-lb)
- Space saving—compact, right-angle design saves space in many applications
- Low backlash—standard as low as 8 arc-minutes and 4 arc-minutes optional
- Smooth, quiet operation and long life—hardened precision spiral bevel gears ensure quiet operation
- Quick, error-free mounting to any servo or stepper motor using Parker's ServoMount® design
- Sealed unit: seals and O-rings provide IP65 protection to prevent leaks and to protect against harsh environments

## Integral Gearmotor & Custom Solutions



Stealth® Gearmotors represent the first time a brushless servo motor and a helical planetary gearhead have been integrated into a single product. Previously, engineers needing a gear drive with servo motor were forced to purchase the gearhead and motor separately. Parker manufactures servomotors, precision gearheads, and gearmotors under one roof for quick integration.

### GM Series Gearmotors

- Helical planetary in-line gearmotors in frame sizes from 60 to 142 mm and NEMA 23 to 56
- Continuous torque from 3 to 60 Nm (27 to 533 in-lb)
- Encoder/resolver feedback

### Custom Wheel Drive

- Integral 6- and 8-inch wheel drive
- 12, 24, 36 and 48 volt operation
- 1.5 to 4.5 MPH max speed



# Linear & Rotary Positioners

## Linear & Rotary Positioners Selection Guide

### Linear Motor-Driven Positioners

SERIES	Page number	Max Normal Load (N)	Max Axial Thrust (N)	Max Speed (m/s)	Positional Repeatability (µm)	Max Travel (mm)	IP Rating	Profile Width (mm)	Overall Height (mm)																									
LXR	45	80	117	1,774	4,410	9,500	8	50	355	879	2,230	2	3	7	± 0.1	± 0.4	± 1.0	200	500	2,745*	2,941*	3,000	IP Rating	80 to 100	101 to 190	191 to 272	273 to 349	25 to 50	51 to 70	71 to 106				
mSR	46	•	•	•	•	•	•	•	•	•	•	•	•	•	•	•	•	•	•	•	•	•	•	•	•	•	•	•	•	•	•	•		
MX	46	•	•	•	•	•	•	•	•	•	•	•	•	•	•	•	•	•	•	•	•	•	•	•	•	•	•	•	•	•	•	•		
T	47	•	•	•	•	•	•	•	•	•	•	•	•	•	•	•	•	•	•	•	•	•	•	•	•	•	•	•	•	•	•	•	•	
TR	47	•	•	•	•	•	•	•	•	•	•	•	•	•	•	•	•	•	•	•	•	•	•	•	•	•	•	•	•	•	•	•	•	•

\* Longer travels available with custom splice kit

### Motorized Rotary Positioners

SERIES	Page number	Max Normal Load (N)	Max Rotational Speed (rpm)	Positional Repeatability (arc-sec)	Travel Range (degrees)	Drive Type	Duty Cycle (%)	Table Diameter mm (in)	Minimum Height mm (in)																												
P Series	48	900	10,000	15,000	20	30	500	± 1.3	± 12	Unlimited	Worm gear	Direct	50	100	< 125 (5")	125 to 150 (5 to 6")	150 to 200 (6 to 8")	200 to 300 (8 to 12")	> 300 (12")	< 50 (2")	50 to 75 (2 to 3")	75 to 100 (3 to 4")	100 to 150 (4 to 6")														
RM	48	•	•	•	•	•	•	•	•	•	•	•	•	•	•	•	•	•	•	•	•	•	•	•	•	•	•	•	•	•	•	•	•	•	•	•	
RT	49	•	•	•	•	•	•	•	•	•	•	•	•	•	•	•	•	•	•	•	•	•	•	•	•	•	•	•	•	•	•	•	•	•	•	•	•

# Modified & Customized Positioner Products & Services

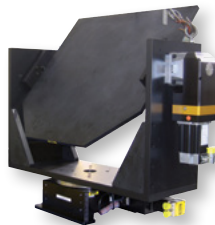
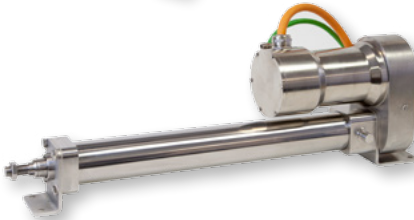
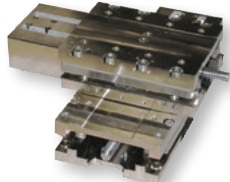

Many of today's applications require unique features not offered in a standard positioning design. Parker has long been an industry leader for customizing solutions and creating tailor-made designs based on customer requests and collaborative engineering.

This ability to provide perfect-fit solutions in the time frames our customers demand allows Parker to differentiate themselves from the non-user friendly design restrictions of other manufacturers.

Some of our customers' requirements have included special environmental conditions, optical needs, aesthetic needs, loading orientation, accuracy demands, space constraints, and more.

A partial list of some of the standard modifications we have designed includes:

- **Conformal coating for circuit board protection**
- **Custom color anodize/ paint for optical or aesthetic purposes**
- **Private labeling for OEM brand management**
- **IP65 electric cylinders for washdown environments**
- **Epoxy coating for harsh chemicals**
- **Low ESD coatings for electrically sensitive environments**
- **Cleanroom designs down to Class 1 with test report capabilities**
- **Custom space constraint designs maximizing travel per overall length**
- **High force designs for maximizing thrust force capabilities**
- **Miniaturized motion for lab instruments**

*Please review our Modified and Engineered System Solutions section on page 53 for more information on Parker capabilities for modified and customized positioning systems and engineered solutions.*

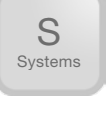

# Linear & Rotary Positioners

## XR Series Precision Screw-Driven Positioners



[http://bit.ly/AT\\_XR](http://bit.ly/AT_XR)

The award-winning XR Series is globally recognized for consistent accuracy, reliable performance, high strength, and unmatched versatility. XRs excel in industries such as life sciences, fiber optics, and instrumentation, where the highest degree of precision is required. The rugged construction, strength, and sealed design make the XR ideal

for highly precise industrial automation applications, like precision grinding and machine tool applications.

The XR family offers an unrivaled array of features and modularity that easily match any application, from very basic to highly complex. Superior performance, modularity, and quick delivery make these tables perfect building blocks for multi-axis positioning systems. Options like class 10 cleanroom prep, field installed assemblies (brakes or parallel motor mounts), easy lube options, and much more distinguish the XR family amongst its peers.

- Precision ground ballscrew
- Low profile machined aluminum body
- 100% duty cycle
- 5 profiles from 41 x 50 mm to 285 x 105 mm (w x h)
- Travel lengths to 2 m
- Load capacities to 14,400 N
- 2g acceleration
- $\pm 1.3 \mu\text{m}$  bi-directional repeatability on most models
- Stiff square rail bearings
- Flexible motor mount
- Laser certified precision
- Proven IP30-rated strip seal
- Dowel holes for precise mounting
- Optional linear feedback, brake, sensor pack, cleanroom prep

## HMR High Moment Rodless Series Industrial Screw or Belt-Driven Positioners



[http://bit.ly/AT\\_HMR](http://bit.ly/AT_HMR)

Parker Hannifin's new, High Moment Rodless linear actuator series is one of the most user friendly and versatile actuator lines on the market today. With 5 different frame sizes, 2 different drive train options, multiple mounting and carriage options, and an IP54 protective cover option, along with a multitude

of other customizable features the HMR was designed with true flexibility in mind.

Guided by two square rail bearings, the HMR has enormous moment and payload capacity bundled in a low profile, yet sleek package. HMR actuators provide ideal performance for industrial applications that do not require the same level of precision as the XR series, but demand the ultimate in flexibility, ease of use, and simplification of machine integration.

- 5 profile sizes: 85, 110, 150, 180 and 240mm
- Dual drive train with ball screw or high efficiency timing belt
- Load capacity up to 26,600N
- Max thrust to 5,560N (screw) and 4,000N (belt)
- Standard strokes up to 2,300mm (screw) and 6000mm (belt)
- Max speed to 1.6 m/s (screw) and 5 m/s (screw)
- 2 Profile types: Basic and Reinforced
- Tandem and bi-parting carriage options
- Optional sensor locations: internal (protected under the cover) or external
- IP54 rated cover option
- Ambient temperature range: -30°C to +80°C

	Screw-Driven	Belt-Driven
Positional Repeatability – $\mu\text{m}$	$\pm 20$	$\pm 50$
Travel Range – mm	5 – 2,300	Up to 6,000
Maximum Speed – m/s	1.6	5.0
Axial Thrust Capacity – N	5,500	4,000
Maximum Normal Load – N	26,000	26,600



## XE Series Economy Screw-Driven Positioners

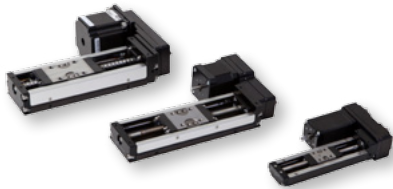

401, 402, and 403 XE Series Positioners  
[http://bit.ly/AT\\_XE](http://bit.ly/AT_XE)

The 401, 402, and 403 XE Series of positioners combines a rugged steel body construction with an integrated ballscrew and bearing guide. The result is a highly accurate, cost-effective line of positioners ideal for applications in the hard disk, semiconductor, medical, machine building, and many other industries.

- **Significant force-per-dollar value**
- **Easily integrated into multi-axis designs**
- **Small package size**
- **Profiles from 30 x 15, 50 x 23, and 60 x 30 mm (w x h)**
- **Travel lengths to 655 mm**
- **Load capacities to 160 kg**
- **2g acceleration**
- **±5 µm repeatability**
- **Flexible motor mounts, to either steppers or servo, both inline or parallel**

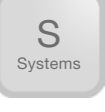

404 XE Series Positioner  
[http://bit.ly/AT\\_XE](http://bit.ly/AT_XE)

The 404 XE positioner combines versatility and rugged construction into a compact platform ideal for 100% duty cycle automation applications. Like its cousin the 404 XR, the 404 XE offers a myriad of options and accessories. The XE is also mount compatible with the XR and LXR positioners, allowing a mix and match of technologies to balance system cost and performance.

- **Reliable, cost-effective positioner**
- **Short carriage and parallel motor mounts to minimize length**
- **High-strength design**
- **Multi-axis configurations**
- **Profile of 95 x 48 mm (w x h)**
- **Travel lengths to 700 mm**
- **Load capacities to 1400 N**
- **2g acceleration**
- **±20 µm repeatability**

## MX Series Miniature Screw-Driven Positioners



[http://bit.ly/AT\\_MX](http://bit.ly/AT_MX)

The MX80-S, and MX45-S are screw driven miniature positioners, which use integrated cross roller bearings as their guidance. Like its linear motor-driven counterpart, the MX is designed for applications requiring reliable linear positioning in space-restricted applications.

The MX is equipped with a high-efficiency leadscrew drive capable of reaching 200 mm per second velocity. The leadscrew drive employs a PTFE-coated leadscrew with a preloaded nut to produce extremely smooth and quiet linear translation. A choice of three leads provides improved opportunity for matching desired velocity/resolution requirements.

The MX can also be supplied with a precision ground ballscrew drive. The 2.0 mm lead ballscrew provides high performance 24/7 operation with a thrust load capacity up to 123 N (28 lb) and velocity to 100 mm/second at 100% duty cycle.

- **Low-profile miniature size**
- **Cleanroom environment option**
- **Up to 150 mm travels**
- **Multi-axis platform**
- **Ballscrew or leadscrew drive options**
- **Up to 123 N axial thrust**
- **2g acceleration**
- **Cross roller bearing (zero cage creep option)**
- **Stepper or servo motor drive options**
- **Digital limit/home system**
- **Optional linear encoder**
- **Low ESD option for electrically sensitive applications**

# Linear & Rotary Positioners

## LCR Series Light-Capacity Screw- or Belt-Driven Positioners



[http://bit.ly/AT\\_LCR](http://bit.ly/AT_LCR)

Light Capacity Rodless (LCR) Series positioners are ideal for OEM lab instrument and machine builders looking for significant ROI for an off-the-shelf yet tailor-made solution. The LCR provides unmatched flexibility with a choice of two profile sizes, two bearing options, three drive train options, many motor options (both inline and parallel) and the option to include the modular P2™ stepper drive.

The LCR Series will reduce the total design time, lessen the overall cost of development, and increase your return on investment.

	Screw-Driven	Belt-Driven
Positional Repeatability – $\mu\text{m}$	$\pm 100$	$\pm 200$
Travel Range – mm	5 – 600	Up to 1,000
Maximum Speed – m/s	0.2	5.0
Axial Thrust Capacity – N	75	30
Maximum Normal Load – N	100	100

### LCR Applications

- **Liquid handling: pipetting, aspirating, dispensing**
- **Laboratory automation: microtiter tray, well plates, slide automation**
- **Electric gripping**
- **Laners and diverters for light packaging conveyors**
- **Point of purchase / kiosk automation**

### Advantages

- **Lower design costs**
- **Reduced component complexity**
- **Reduced inventory costs**
- **Reduced time to market**
- **Higher ROI**
- **ISO qualified supplier**
- **Simplified procurement process with one point of contact for the complete motion system**

## OSP-E Series Medium-Capacity Screw or Belt-Driven Positioners



[http://bit.ly/AT\\_OSPE](http://bit.ly/AT_OSPE)

The OSP-E Series offers a medium-capacity, flexible, value-priced screw-driven or belt-driven actuator. The OSP-E simplifies the crossover to electric actuation from pneumatics, with dimensional equivalents to the Parker Origa OSP-P pneumatic line of products.

With options for glider bearings, square-rail bearings, or the robust roller-wheel design, the OSP-E offers users the ability to balance cost and performance.

- **Simple pneumatic to electromechanical conversion**
- **Stepper or servo motor compatibility**
- **Ball or trapezoidal lead screw-drive options**
- **High-thrust-force designs**
- **Cleanroom options**
- **IP54 sealing design**
- **Bushing, roller-wheel, or square-rail bearing designs**

	Screw-Driven	Belt-Driven	BHD
Positional Repeatability – $\mu\text{m}$	$\pm 50$	$\pm 50$	$\pm 50$
Travel Range – mm	3,200	Up to 5,000	Up to 5,760
Maximum Speed – m/s	1.25	5.00	10.00
Axial Thrust Capacity – N	2,500	425	3,120
Maximum Normal Load – N	3,000	850	15,000

## HPLA/HLE Series Industrial Belt-Driven Positioners



[http://bit.ly/AT\\_HPLA](http://bit.ly/AT_HPLA)



The HLE/HPLA linear modules are ideal as single-axis products or as components for high-speed multi-axis gantries. With thousands of units in operation worldwide, the HPLA/HLE Series are proven performers offering long life and trouble-free operation.

With flexible design options for bearing selection, profile size, stroke length, and motor/gearbox combination, the HPLA/HLE design has your application covered.

- **Rugged construction for heavy duty applications**
- **Thrust force capacity to 5455 N**
- **Standard travel up to 9 meters**
- **Velocity up to 5 m/s**

- **Positional repeatability of  $\pm 0.2$  mm**
- **Timing belt and pulley drive mechanism for fast, accurate positioning**
- **Increased system stiffness due to larger belt width**
- **Low-maintenance sealed bearings**
- **Hollow-shaft input option for higher axial forces**
- **Steel-wheel or square-rail designs for normal load capacities up to 15 kN**
- **Quiet operation**
- **Corrosion-resistant option for harsh environments**
- **IP30 seal design**

## ERV Series Value Line Belt-Driven Positioners

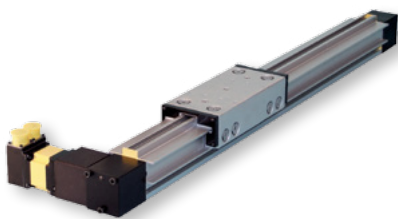

[http://bit.ly/AT\\_ERV](http://bit.ly/AT_ERV)

Parker's ERV Series rodless actuator is an affordable package that includes an extruded base and an external carriage containing outboard roller bearings for high load capacity.

Utilizing the HPLA/HLE composite wheels with a wider wheel base, the ERV offers extremely high roll-moment capacity due to a superior bearing separation distance. The result of this separation is a high moment load per package size. All of the added force density is delivered in a value-priced belt-drive package.

- **High-strength extruded body**
- **External bearing carriage for high loads up to 3,590 N**
- **Economical design for high-load and high-speed applications**
- **Easy-to-use belt-tension access hole**
- **Parker IPS-compatible T-slots and mounting options (IPS 56 & 80 mm profiles)**



# Linear & Rotary Positioners

## OSPE-BV and HLE-Z, Vertical and Long-Travel Positioners



[http://bit.ly/AT\\_HLEZ](http://bit.ly/AT_HLEZ)

The OSPE-BV actuator utilizes a fixed pulley and drive design allowing the actuator body to shuttle in and out, thus retracting from the workspace. This square rail guided, belt driven actuator has high speed capability and stiff guidance making it an ideal solution for vertical applications.

The HLE-Z "endless" linear units are designed for guiding, transporting, and positioning payloads over long travel distances with high rigidity and accuracy.

This is accomplished by incorporating Parker's uniquely designed rack-and-pinion-based drive system with an HLE150 or HPLA180 linear module housing.

The exceptional dynamic characteristics inherent in these units make them well suited for applications requiring high-speed linear translation and positioning.

- **Long travels—selectable up to 50 meters**
- **Load capacities up to 15,000 N**
- **Up to 5 meters/sec. velocity**
- **±0.05 mm positional repeatability**
- **Rack-and-pinion drive mechanism**
- **Independent multiple carriages on single rail**
- **Roller wheel bearings for smooth, high-speed linear motion**

## HZR Vertical-Axis Belt-Driven Positioners



[http://bit.ly/AT\\_HZR](http://bit.ly/AT_HZR)

The HZR is a rugged vertical-axis unit unique to the high-speed automation industry. It is specifically designed to satisfy the mechanical demands placed on the vertical axis of a multi-axis gantry robot—utilized for high throughput lifting and transporting of heavy or bulky loads.

- **Designed as a vertical-axis unit**
- **Load lifting capacities up to 1500 N**
- **Velocity up to 5 meters/sec.**
- **Positional repeatability of ±0.2 mm**
- **Torsion-resistant housing**
- **Roller wheel bearings for smooth vertical motion**
- **High vertical acceleration**

# LXR Series Precision Linear Motor-Driven Positioners



[http://bit.ly/AT\\_LXR](http://bit.ly/AT_LXR)

The 400LXR Series linear servo motor tables offer high acceleration, velocity, and precision with quick settling for superior throughput. Optimum performance is achieved by combining slotless linear motor technology with performance-matched feedback and mechanical elements.

Offered in three widths that complement the XR with a myriad of options, the 400LXR Series can solve most high-performance applications.

- **Incremental standard lengths from 50 mm to 3 m**
- **Load capacity to 9310 N**

- **5g acceleration**
- **Velocity up to 3 m/s**
- **Continuous force to 355 N, peak force to 1000 N**
- **±1 µm repeatability**
- **100% certification of precision with test reports in every shipment**
- **Cleanroom preparation**
- **Easy multi-axis configuration**
- **Pre-engineered, low-profile, modular cable management**
- **Proven IP30 strip-seal protection**
- **Encoder resolutions to 0.1 µm**
- **Fast settling**
- **Dowel holes provided for precise payload and multi-axis mounting**



## XRS Cartesian Systems

Parker XRS Series “standard” Cartesian robot modules are the ideal solution for cost effective automation in life sciences, semiconductor, electronics, automated assembly, dispensing, and many other applications.

Standard XRS Systems are pre-engineered to optimize work-space, simplify selection, shorten delivery and lower costs.

### Scalability

With 3 size platforms and 124 standard systems you can find a standard solution for your application.

### Technology

A unique mix of linear servo motor and ballscrew drive technology provides optimized dynamic performance for today’s demanding automation applications.

### Reliability

XRS Systems are built from Parker’s XR/LXR linear positioners, time tested and proven in thousands of applications worldwide.

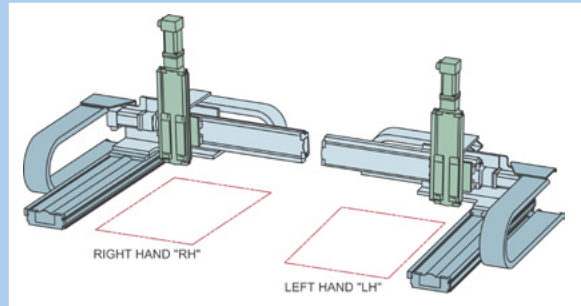

[http://bit.ly/AT\\_XRS](http://bit.ly/AT_XRS)

### Small Platform XRS Cartesian Systems

- Smaller footprint for light loads and shorter travels
- Maximum X-Y work area: 600 mm X 300 mm
- Maximum load: 5 kg

### Medium Platform XRS Cartesian Systems

- For mid-range loads and travels
- Maximum X-Y work area: 1000 mm X 600 mm
- Maximum load: 12 kg

### Large Platform XRS Cartesian Systems

- For heavier loads and travels
- Maximum X-Y work area: 1000 mm X 1000 mm
- Maximum load: 25 kg

# Linear & Rotary Positioners

## mSR Miniature Square Rail Linear Motor-Driven Positioners

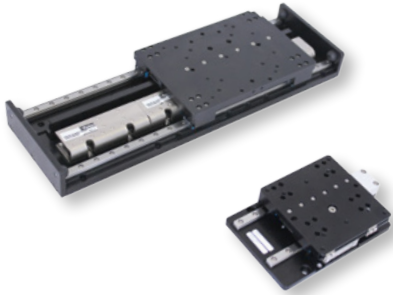

[http://bit.ly/AT\\_MSR](http://bit.ly/AT_MSR)

The mSR series positioner is ideal for instrument builders who need smooth motion in a small package. The mSR is a linear positioner that provides submicron level precision in two different form factors (80 and 100).

The mSR series is a precision machined, square rail bearing guided linear positioner which is driven with one of two different linear servo motor technologies, and it utilizes selectable levels

of linear encoder technology that are configured to match the application need. Within the same form factor, OEMs have two options.

The precision grade mSR is the most accurate standard positioner ever made by Parker Electromechanical, achieving a repeatability of 100 nm and an accuracy of 5.0 microns over 50 millimeters of stroke.

The more cost competitive standard version takes advantage of magnetic encoder technology, which is ideal for applications which do not require the same level of precision, allowing it to compete with similar ballscrew driven stages.

- 80 x 25 or 100 x 35 mm form factors
- Dual precision square rail bearings
- Six different linear encoder options
- Two different linear motor technologies
- Standard travel options ranging from 25 mm to 500mm of stroke
- Integrated and adjustable home and limit sensing
- Common tapped mounting holes and dowel locating holes
- Complete error mapping on each precision grade version—with linear slope correction value provided
- CE and RoHS Compliance
- A standard magnetic counterbalance (mSR 80 with 25 mm stroke)

## MX Miniature Cross Roller, Linear Motor-Driven Positioners



[http://bit.ly/AT\\_MXL](http://bit.ly/AT_MXL)

Miniaturization of fiber optics, photonics, electronics, and biomedical processes has driven the need for smaller and more efficient positioners.

Parker's MX miniature stage, the smallest linear servo motor-driven positioner in the industry, is loaded with high-performance features for both rapid linear

translation and precise positioning of lighter loads in small work envelopes. Designed for today's 24/7 production demands, the MX has redefined "high-throughput automation" in the world of miniature positioners.

- 5 g acceleration
- Fast settling
- Submicron precision
- High velocity (2 m/s)
- Multi-axis platform
- Low-profile miniature size - (25 mm high X 80 mm wide)
- Linear servo motor drive
- Linear encoder resolutions (0.01  $\mu\text{m}$  to 5.0  $\mu\text{m}$ )

- 25 to 200 mm travels
- Cross roller bearing (zero cage creep design)
- Precision or standard grade
- Cleanroom and low-ESD options
- Fully adjustable home and limit sensors
- Dowel holes for repeatable mounting of payload
- Master reference surface to travel path
- "Plug-in" factory configured drive/controller
- Pneumatic z-axis counterbalance
- No moving cables

## T Series Smooth Motion Ironless Positioners

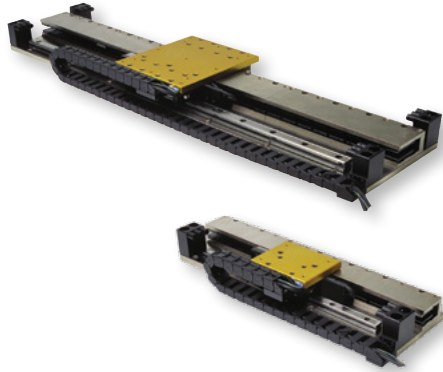

[http://bit.ly/AT\\_T](http://bit.ly/AT_T)

The Parker T Series linear positioners utilize our high-performance ironless linear motors in a pre-engineered, easily integrated, ready-to-run package.

The T Series advantages include economical cost and design flexibility to accommodate customization.

- **Incremental standard lengths from 100 mm to 2.9 m (extended lengths optional)**
- **Load capacity to 1774 N**
- **5g acceleration**
- **Velocity up to 7 m/s**
- **Continuous force to 878 N, peak force to 3928 N**
- **$\pm 1 \mu\text{m}$  repeatability**

- **Ground steel or aluminum bases to meet high-accuracy requirements for straightness and flatness**
- **Single- or dual-bearing rail positioners match performance and cost requirements**
- **Includes a magnetic encoder for industrial environments or an optical encoder with resolutions down to  $0.1 \mu\text{m}$**
- **Multiple carriage and cable track configurations available**
- **Options include a variety of bellows, hard covers, and brackets for X-Y and X-Y-Z multi-axis configurations**

## TR Series High Force Ironcore Positioners

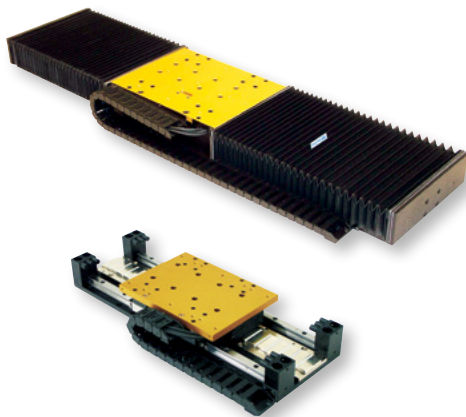

[http://bit.ly/AT\\_TR](http://bit.ly/AT_TR)

The Parker TR Series linear positioners utilize our high-performance RIPPED ironcore linear motors to produce extremely smooth motion for use in many applications where ironless motors were traditionally needed. TR positioners utilize a dual-rail-bearing design for high normal and moment loads.

- **Incremental standard travel lengths from 100 mm to 2.9 m, extended lengths optional**
- **Load capacity to 4410 N**
- **5g acceleration**
- **Velocity up to 7 m/s**
- **Continuous force to 2230 N, peak force to 7433 N**
- **$\pm 1 \mu\text{m}$  repeatability**

- **Ground steel or aluminum bases to meet high-accuracy requirements for straightness and flatness**
- **Includes a magnetic encoder for industrial environments or an optical encoder with resolutions down to  $0.1 \mu\text{m}$  ( $0.00004''$ )**
- **Magnetic home and end-of-travel limits**
- **Options include a variety of cable management systems, bellows, hard covers, and brackets for X-Y and X-Y-Z multi-axis configurations**

HMI  
Visualization

MC  
Machine  
Control

DR  
Drives

MO  
Motors

GH  
Gearheads

P  
Positioners

MP  
Manually  
Driven

EC  
Electric  
Cylinders

IPS  
T-Slot  
Framing

S  
Systems

# Linear & Rotary Positioners

## Motorized Rotary Positioners

### P Series Direct Drive Rotary Motors



The P Series direct-drive rotary motors are well suited for both industrial and high-tech applications.

Direct-drive systems are integrated positioning systems that allow the elimination of mechanical transmissions and allow the load to be mounted directly to the motor.

This creates an extremely high performance system that can simplify and increase the performance of many machine types. The combination of high torque, zero backlash and precision bearing structure results in fast settling time and outstanding accuracy.

- **High resolution 20-bit absolute encoder for accurate positioning**
- **Precision bearing for low axial and radial run-out**
- **Through hole for convenient wiring**
- **Motor nameplate data transfer to P Series drives**
- **Predefined Profile mode provides ideal indexing feature for your machine**
- **EtherCAT gives high speed communication for multi-axis solutions**
- **Low vibration and outstanding mechanical accuracy by improved bearing design**
- **High resolution absolute feedback as standard (20 bit BiSS-C)**
- **High torque density by using highest class rated Neodymium permanent magnet**
- **Optimized winging structure**
- **5 frame sizes with custom height options**
- **Rated speed : 200 rpm / 150 rpm**
- **Automatically recognized by the P Series drive after connection**

### RM Series High-Capacity Worm-Drive Rotary Positioners

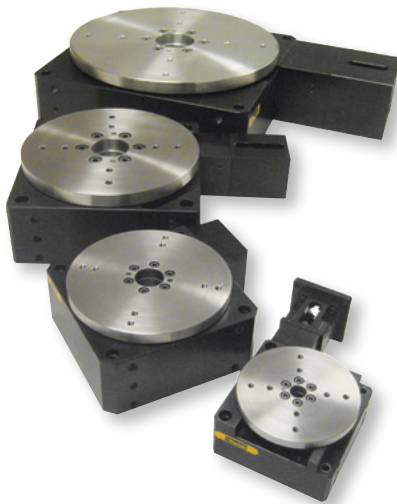

The RM Series offers high load capacity in a compact package. These rotary stages utilize a precision worm gear with the worm “flexed” against the gear to ensure a proper mesh. This feature provides an auto anti-backlash calibration with smooth motion. Additionally, the rotary stages incorporate an oversized preloaded cross roller bearing, offering exceptional stiffness and high normal and moment load capacity.

- **Unique self-compensating preload to limit backlash**
- **Solid table tops or through holes for access**
- **Robust bearing design for high-load capacity (up to 2200 lbs)**
- **Built-in limit switches**
- **Aluminum construction with stainless steel top plate**
- **4 Diameters (100, 150, 200, and 300)**

[http://bit.ly/AT\\_RM](http://bit.ly/AT_RM)



# RT Series High-Precision Worm-Drive Rotary Positioners



[http://bit.ly/AT\\_RT](http://bit.ly/AT_RT)

RT Series rotary tables are designed for precise motor-driven rotary positioning and indexing. These tables are designed to function independently or in conjunction with linear tables used in high precision automation applications.

Their low profile design minimizes stack height in multi-axis configurations and enables them to fit in many places where other motorized rotary devices cannot.

Models are available in 5-, 6-, 8-, 10-, or 12-inch diameters and are offered with four gear ratios making it convenient to match size, speed, and load requirements to application needs. They can be selected in either imperial or metric mounting. They are found in virtually all industries where intermittent part indexing, part scanning, skew adjustment, or precise angular alignment is required.

At the heart of these tables is a rugged main support bearing, which is comprised of two preloaded angular contact bearing races. It is designed for

smooth, flat rotary motion. The drive is a precision worm gear assembly, which is preloaded to remove backlash.

The top and base are constructed of high quality aluminum with an attractive black anodized finish. The top and bottom mounting surfaces are precision-ground to assure flatness.

- **Highly repeatable indexing (12 arc-sec)**
- **Load capacities to 200 lbs**
- **360 degrees continuous travel**
- **Performance-tested worm gear drive**
- **Selectable table sizes and drive ratio**
- **Dual race angular contact support bearing**
- **Center aperture for cables or optics to pass through**

HMI  
Visualization

MC  
Machine  
Control

DR  
Drives

MO  
Motors

GH  
Gearheads

P  
Positioners

MP  
Manually  
Driven

EC  
Electric  
Cylinders

IPS  
T-Slot  
Framing

S  
Systems

# Linear & Rotary Positioners

## Manually Driven Positioners

### Free-Travel Slides and Bearings



[http://bit.ly/AT\\_SL](http://bit.ly/AT_SL)

Parker offers a complete line of ball slide and crossed roller slides that is among the most extensive in the industry.

Ball slides are mechanically simple linear bearings, which are designed and assembled to provide exceptional smoothness and linear straight line accuracy. This is achieved by the ball and rod linear bearing design.

Crossed roller slides are very similar to ball slides, except the ball and rod linear bearing is replaced with a crossed roller slide bearing system. Crossed roller slides have higher load-carrying capability and significantly increased stiffness.

- **Imperial and metric mounting available on most models**
- **Precision machined mounting surfaces ensure flatness**
- **Widths from 31.8 to 152 mm (1.25 to 6.0")**
- **Travels to 762 mm (30")**
- **Loads to 2000 N (448 lbs) for ball slides; 12000 N (2,738 lbs) for crossed roller slides**

### Micrometer-Driven Slides and Stages



[http://bit.ly/AT\\_SL](http://bit.ly/AT_SL)

Parker manual positioners combine a ball slide or a crossed roller slide with a drive mechanism. The slide is spring loaded against the drive mechanism to provide a constant preload between the drive and the carriage.

Ball bearing positioners provide ultra-smooth, extremely low-friction motion by minimizing bearing contact area.

Additionally, this design provides extremely good straight-line and flatness accuracy.

Crossed roller positioners have higher load-carrying capability than comparably-sized ball bearing positioners due to the larger (line) contact surface. The crossed roller design also significantly increases stiffness.

Both designs are preloaded to eliminate any side play and to provide a uniform coefficient of friction.

- **Imperial and metric mounting available on most models**
- **Precision machined mounting surfaces ensure flatness**
- **Widths from 31.8 to 152 mm**

(1.25 to 6.0") for ball bearing versions; 44.5 to 152 mm (1.75 to 6.0") for cross roller versions

- **Travels to 300 mm (12")**
- **Loads to 133 kg (294 lb) for ball bearing versions; 786 kg (1735 lb) for cross roller versions**
- **Center or side drive configurations**
- **Available with a choice of drive mechanisms including:**
  - fine adjustment screw
  - differential screw
  - imperial and metric micrometer heads
  - digital micrometer heads

# Non-Motorized Rotary Positioners

HMI  
Visualization

MC  
Machine  
Control

DR  
Drives

MO  
Motors

GH  
Gearheads

P  
Positioners

MP  
Manually  
Driven

EC  
Electric  
Cylinders

IPS  
T-Slot  
Framing

S  
Systems

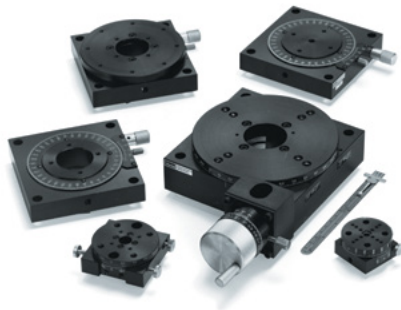

[http://bit.ly/AT\\_SL](http://bit.ly/AT_SL)

Parker rotary stages are designed to produce precision rotary motion. The basic components in these stages are a base, main bearing, drive mechanism and top (load platform). The base of all the units house the main bearing and drive mechanism and is designed to be mounted to a stationary surface.

The main bearings provide low-friction contact between the base and top. The drive mechanisms used are either tangent arms or worm gears. The table top provides a mounting surface for mounting payloads.

## Tangent Arm Drive

Tangent arm drives produce very fine resolution over a limited rotary travel range. Angular rotation is controlled by three control knobs. The release knob disengages the shaft from the drive, freeing the table to be rotated by hand to a desired location.

The release knob is then tightened to re-engage the drive mechanism and transfer control to the adjustment knob, which, when rotated, produces precise angular positioning of the shaft and table top. The locking knob can then be used to positively lock the table at the desired setting.

- **Imperial and metric models**
- **Rotary platform diameters from 47.7 to 66.5 mm (1.88 to 2.62")**
- **Load capacity to 4.5 kg (10 lbs)**

## Worm Gear Drive

A precision worm gear drive mechanism consists of a worm wheel (gear) and worm drive. Controlled rotation of the worm drive shaft creates precise angular rotation of the worm wheel and table top.

The worm gear and shaft are matched sets and are preloaded to remove backlash. This type of drive provides high resolution (180:1) and continuous angular positioning over a full 360° range.

- **Imperial and metric models**
- **Rotary platform diameters from 69.8 to 305.0 mm (2.75 to 12.00")**
- **Load capacity to 90 kg (200 lbs)**

# Electric Cylinders

## Electric Cylinder Selection Guide

		Product Families																										
		Thrust (kN)			Max Speed (m/s)	Max Travel (mm)	Drive Type	Frame/Bore Size (mm)										Repeat-ability (mm)										
		Page number	2.1 max (470 lbs)	114.0 max (25,618 lbs)	356.0 max (80,000 lbs)	1.0	1.7	10.0	730	2,000	Metric Ball Screw	Tubular Linear Screw	Planetary Roller Screw	25	32	50	75	80	90	100	115	125	140	165	190	± 0.03	± 0.05	
SERIES																												
ETH	52	•	•	•	•	•	•	•	•	•	•	•	•	•	•	•	•	•	•	•	•	•	•	•	•	•	•	•
ETT	53	•	•	•	•	•	•	•	•	•	•	•	•	•	•	•	•	•	•	•	•	•	•	•	•	•	•	•
XFC	53	•	•	•	•	•	•	•	•	•	•	•	•	•	•	•	•	•	•	•	•	•	•	•	•	•	•	•

## ETH Series High-Force Electric Cylinders

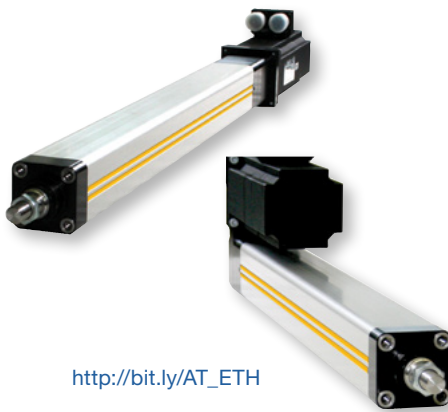

[http://bit.ly/AT\\_ETH](http://bit.ly/AT_ETH)

The ETH is the next generation of electric thrust cylinder product that utilizes a completely new integrated drive train and guidance design. This results in greatly improved overall thrust capacity within a smaller overall footprint, producing a cylinder with industry leading power density.

The ETH is designed to compete with similarly sized roller screw products and offers an energy efficient solution to hydraulic actuation. The new integrated design creates a more durable unit overall that has dramatically increased product life characteristics.

ETH cylinders are engineered to be extremely user-friendly, employing a wide range of configurable options to allow for true application optimization. They can be configured with either inline or parallel motor mounting options to allow for accommodating tighter space constraints.

With a standardized ISO footprint, ETH cylinders can be designed into existing fluidpower applications, adding programmability and the option of closed loop control as well as high durability and long life. Due to the high mechanical efficiency of an electric cylinder they offer lower overall cost of ownership relative to similarly sized fluid power systems.

With five different frame sizes to meet a multitude of application demands, the ETH family has been optimized to fit almost any industrial requirement, and has been successfully implemented in applications such as test and laboratory equipment, valve and flap actuation, press equipment,

food and beverage process automation, packaging, and a multitude of general handling applications.

- **Flush mount sensors and cables (which can be hidden with slot cover)**
- **Easy lubrication port reduces maintenance costs**
- **Reduced noise emission**
- **ISO flange norm conformity (DIN ISO 15552:2005-12)**
- **Greatly increased product lifetime (5 times longer life)**
- **Strokes up to 2000 mm**
- **Speeds up to 1.7 m/s**
- **Increased parallel motor mount torque capacity**
- **Predefined standard motor and gearbox flanges for quick selection available directly from Parker (one-stop shopping)**
- **3 different protection classes available:**
  - IP54 with galvanized fasteners and hardware
  - IP54 with stainless steel fasteners and hardware
  - IP65 (on request)

## ETT Series Light-Capacity Tubular Linear Motor

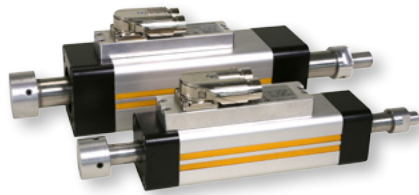

[http://bit.ly/AT\\_ETT](http://bit.ly/AT_ETT)

Parker's ETT Series of tubular style linear motor offers a unique solution for machine builders, OEMs, and users alike. The tubular motor is made up of two main components: the stator with integrated feedback (body) and the rod (shaft) with embedded magnets, making it a direct driven, rod-style, thrust actuator.

The ETT is characterized by its high speed, high acceleration, and dynamic positioning capability, giving it superior control and

lower overall cost of ownership as compared to typical pneumatic positioners due to its high efficiency and overall energy savings.

Having full compliance with the DIN ISO 15552:2005-12 mounting standard ensures simplicity of mechanical integration of the ETT and reduces overall design complexity. A wide variety of optional accessories are available for the ETT to facilitate ease of mounting.

The ETT's linear motor technology eliminates the need for an additional belt or screw, gearhead, and motor as in many electro-mechanical positioners, creating greater performance in a smaller overall package.

This reduction of components also serves to mitigate overall system cost and reduce installation costs. By eliminating bearing components, potential wear items are removed equating to drastically reduced overall maintenance. The ETT is ideally suited for any pick and place or linear handling application requiring high dynamic performance.

- **ISO 15552:2005-12 mounting footprint**
- **Continuous thrust from 8 to 295 N**
- **Peak thrust from 32 to 1179 N**
- **Max speed of 5.2 m/s**
- **Max acceleration of 270 m/s<sup>2</sup>**
- **IP67 rated**

## XFC Series Extreme-Force Electric Cylinders



[http://bit.ly/AT\\_XFC](http://bit.ly/AT_XFC)

Parker's XFC series features roller screw drive technology. This industrially hardened cylinder product utilizes an all steel construction and is manufactured to standard metric hydraulic tie rod design.

It offers significantly greater levels of control in addition to being an energy efficient fluid power substitute. Roller screw technology allows the XFC to achieve far greater thrust capacities than typical electric cylinders, delivering a maximum thrust up to 356,000N (80,000lbs).

Planetary rollers instead of typical ball bearings provide an increased number of contact surfaces between the screw shaft and the roller nut, yielding greater stiffness and load capacity and making it ideal for shock loading applications.

- **In-line or parallel gear drive configuration**
- **Multiple screw leads per frame size**
- **Thrust Forces : up to 80,000 lbs**
- **Stroke Lengths : up to 2.000 mm**
- **Repeatability :  $\pm 0.03$  mm**
- **High Mechanical Efficiency – up to 90%**
- **Anti-rotate rod option**
- **Direct input from Parker gearheads**
- **High-speed capabilities of up to 1 m/s**
- **Position and force holding capabilities**

HMI  
Visualization

MC  
Machine  
Control

DR  
Drives

MO  
Motors

GH  
Gearheads

P  
Positioners

MP  
Manually  
Driven

EC  
Electric  
Cylinders

IPS  
T-Slot  
Framing

S  
Systems

# T-Slot Aluminum Framing Solutions

## High-Strength T-Slot Aluminum Framing and Components

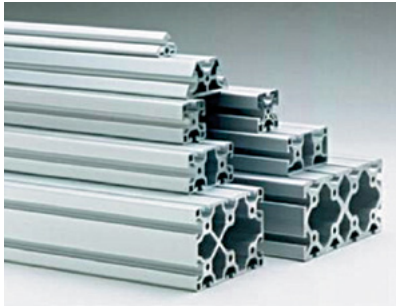

[http://bit.ly/AT\\_IPS](http://bit.ly/AT_IPS)

Parker Industrial Profile Systems (IPS) is a leading value-added manufacturer of high-strength aluminum framing, systems, and components. Our focus is on our customer. By offering local inventory, application engineering, fabrication and assembly, and integration of industry leading Parker motion control products, we strive to exceed our customer's expectations in service, quality, delivery, and value.

### Typical Applications

- Motion system integration
- Enclosures and guarding
- Machine bases and frames
- Work stations and tables
- Material handling systems
- Lean manufacturing tools
- Cleanroom designs

### Benefits

- Extremely short turnaround time from design to completion
- No welding, grinding, cleaning, painting, or distortions
- Eliminates costly traditional manufacturing processes
- Flexibility to re-configure as requirements change

### Your Choice to Suit Your Needs

Selectable Service Levels to suit your needs from a completely assembled structure to a bundle of uncut profiles.

### Assemblies

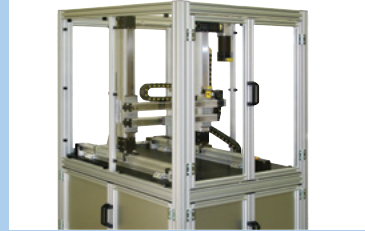

Parker IPS offers complete assembled solutions that are designed, custom fabricated, and shipped in as little as seven business days. (Lead times may vary.)

### Kits



Profiles are cut and machined to order, fasteners and accessories are included based on a parts list, and the entire order is packaged and shipped for final assembly at your location.

### Bundles



Our entire product line can be ordered as bundles of uncut or cut-to-length profiles, with packages of fasteners and accessories.



## Profiles

Parker offers a comprehensive offering of metric and inch based profiles:

- **More than 100 individual high-strength aluminum profiles**
- **All structural profiles are aircraft grade, high strength, mill-certified with metallurgical properties of 6105-T5**
- **Aesthetically appealing extrusions offer best-in-class rigidity, durability, and hardness**
- **Unique T-slot design for reliable connection and easy modification**
- **Metric sizes range from 20 mm to 160 mm; inch sizes range from 1" to 6"**
- **Extensive range of smooth, grooveless profiles**

## Lean Solutions

- **Improve your Quality and Lean Journey**
- **Tracking and Communication, Day by the Hour boards and more**
- **Pre-configured, standard part numbers**

## Tools and Support

Parker IPS offers the tools needed to design and develop your assembly solution. Download the tools you need at:

[www.parker.com/ips](http://www.parker.com/ips)

- **Complete selection and specification information on all IPS products available online in pdf format**
- **3D CAD files for all available IPS products**

Avoid paying too much for an over-engineered solution. Contact our applications team today at 800-333-4932 for quick response and help with designing the best solution.

## Fasteners and Accessories

The design of our structural framing fasteners and accessories takes a number of criteria into consideration, including functionality, aesthetics, strength, ease of assembly, and modular, flexible adaptation.



Parker offers a complete line of accessories to provide the right part for your application including:

- **T-slots, end caps, fasteners, and covers**
- **Gussets, plates and brackets**
- **Handles and hinges**
- **Panels, sliding doors and gate hardware**
- **Feet and casters**
- **Work station accessories**
- **Slide blocks and bushings**

## Panels & Wire Mesh

Panels and wire mesh are available in full sheets or to specified cut-to-size dimensions. Standard panel choices include:

- **Lexan®**
- **Trespa®**
- **Expanded PVC**
- **PVC coated wire mesh**
- **Aluminum composite**

Specialty panels of any material can be ordered for any project.

## Machining Services

Standard machining options include cutting, tapping, drilling, and counter boring. Additional custom machining by our expert machinists ensures that your design is complete and built to your exact requirements.

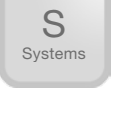

# Engineered Solutions



When it's time to build your motion system, Parker offers cost-effective, easy-to-integrate options. Whether you need standard Cartesian or gantry systems or a custom design—from individual components to complete systems—we'll help you solve your most challenging applications.

When you partner with us, you'll gain access to our motion control

knowledge, experience, and support while improving ease of integration and multi-technology component compatibility. Plus, you'll reduce design time, get to market faster, and save on your total in-house costs.

We combine a wealth of technical expertise with our extensive portfolio of automation products to engineer the solution that's right for you.

## Standard System Solutions

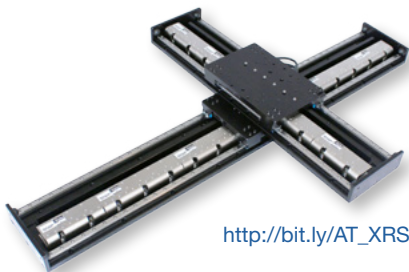

[http://bit.ly/AT\\_XRS](http://bit.ly/AT_XRS)

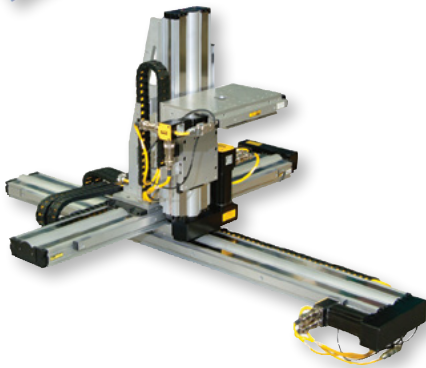

XRS "Standard" Cartesian Systems

For applications that require cost-effective, high-performance systems and quick delivery, the XRS Series of "standard" Cartesian robot modules delivers the ideal solution.

Available in small, medium, and large platform sizes, XRS systems are a combination of 124 pre-engineered XY and XYZ configurations. A mix of ballscrew and linear motor technology matches the system's performance to the application's requirements, and systems are fully equipped with mounting brackets, motors, and cable management. Paired with Parker's industry-leading drives and motion controllers, XRS systems offer engineers a

complete high-performance, "off-the-shelf" system solution with lead times similar to those of single-axis stages.

- **XY and XYZ configurations**
- **Unique mix of linear motor and ballscrew technologies**
- **Right- and left-hand versions**
- **Work areas to 1 m x 1 m**
- **Payloads: 5, 12, and 25 kg**
- **Pass-through, high-flex cabling for power, signals, and air**
- **Dowel holes for repeatable system and payload installation**
- **3-D CAD drawings available**
- **Easy customization for specialized travel, load, and environmental considerations**



# Modified System Solutions

Gantry-Style Robot Systems

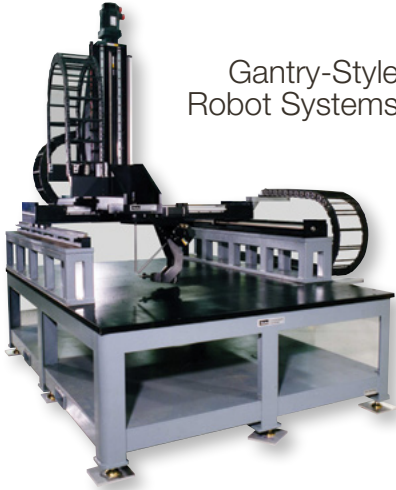

When your application requires a solution that goes beyond our standard options, Parker will combine existing products with engineered components in configurations that work for just about every application.

From small 2-axis precision systems in life-sciences to large gantry-style robots in pick-and-place and packaging, Parker's extensive product portfolio can address most system needs. Using one of Parker's six basic XY, XZ, and XYZ configurations minimizes design time and cost. When machine builders and OEMs need innovative answers, we engineer solutions at all stages of the project.

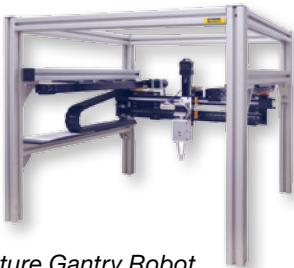

Miniature Gantry Robot

We also supply products beyond the base electromechanical components for a total system solution. Structural aluminum components are available for custom framing and guarding, and pneumatic products round out critical technology components.

Whether it's cylinders, grippers, vacuum cups, air valves, air filters, regulators, or lubricators, if you need it, we'll supply it.

- **Six basic styles available in XY, XZ, and XYZ standard configurations**
- **Unlimited custom configurations available**
- **Payloads up to 250 kg**
- **Velocity up to 4 m/s**
- **Economical robotic solution**
- **Sizing and selection available for standard systems**
- **Easy customization**
- **Automated storage and retrieval systems**
- **Cleanroom compatible**

### Optional Hardware

- **Cable management**
- **Machine base platforms**
- **Machine safeguarding**
- **Pneumatic actuators**
- **Vacuum cups and generators**



Cartesian Work Cell Systems

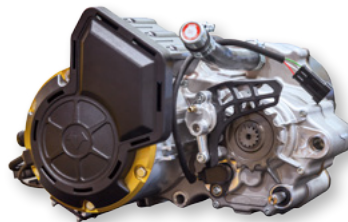
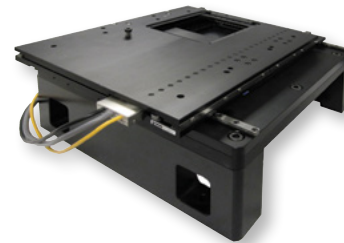

Custom Traction Motor

Parker Engineered System Solutions



# Engineered Solutions

## Motion System Development

When your application requires high volume, high complexity, and high demand system operation, Parker's engineering team is dedicated to developing the complete solution that meets your needs. Elements such as air-bearings, custom linear motors, custom controls, granite bases, pneumatic technology, and special testing with composite and conventional materials create a total engineered solution.

When you partner with Parker, we use an industry-leading six-step process to manage the development cycle and track the project management of these engineered systems.

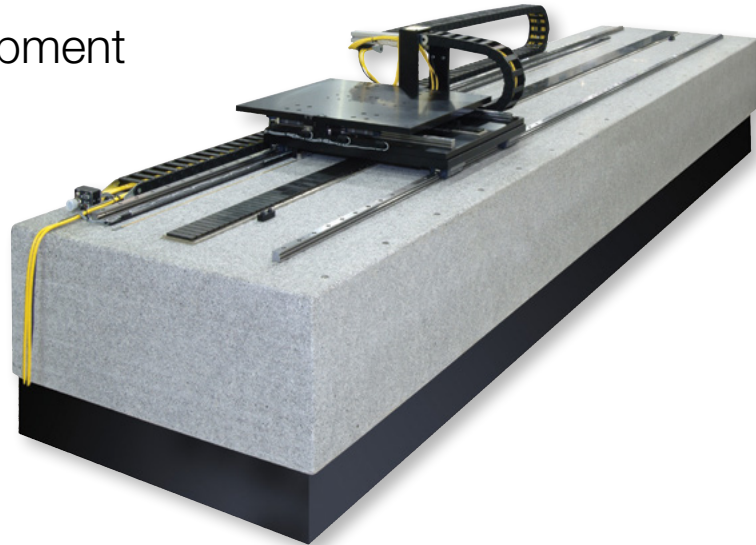

The customization and innovation in these solutions means we maintain the strictest confidentiality on each application. We develop long term partnerships and promote our customer's growth as we solve their most pressing engineering needs.

From conception to completion, we are your global technology partner of choice, and we're committed to engineering your success.

## Parker's Six-Step Project Management Process



### 1. Understand Your Needs

Based on a review of your goals, we help develop a rigorous definition of system requirements.



### 4. Project Management

A project manager assigned to your project uses a secure, web-based tool to manage progress and keep everyone in the loop.



### 2. System Analysis

Proprietary software analyzes the proposed system value and optimal component sizing.



### 5. Accept Test Procedure

This mutually agreed upon document outlines the procedures, tools and methods used to verify that all project performances meet desired specifications.



### 3. Solution Proposal

We document the system requirements, cost effectiveness of options, proposed system design and analysis, price quotation and delivery schedule.



### 6. After-Sales Support

We include an engineer on site during delivery, machine inspection, training, maintenance, and 24/7 support.

## Find More Online...

For complete information on all our Parker Electromechanical products including products not covered in this overview, please visit our website at:

[www.parker.com/emn](http://www.parker.com/emn)

In addition to comprehensive product information, the site also offers a host of other resources including:

- **Application stories**
- **Engineering reference corner**
- **Sample markets**
- **Product manuals**
- **3-D CAD files**
- **FAQ**
- **RSS news feeds**
- **Locate your local ATC**
- **Buy online**
- **And much more!**

In addition to our electromechanical motion products, Parker Hannifin offers thousands of product lines ranging from viton seals and brass fittings to hydraulic cylinders with kilo-newtons of force.

To find out more about the complete Parker Hannifin family of products, please visit our corporate home page at:

[www.parker.com](http://www.parker.com)

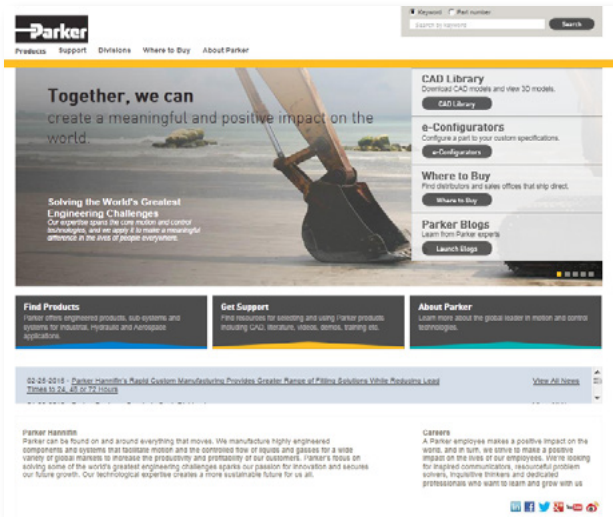
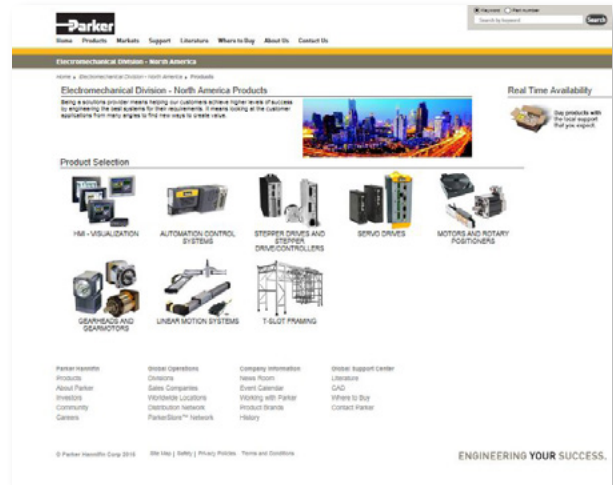

### WARNING - USER RESPONSIBILITY

FAILURE OR IMPROPER SELECTION OR IMPROPER USE OF THE PRODUCTS DESCRIBED HEREIN OR RELATED ITEMS CAN CAUSE DEATH, PERSONAL INJURY AND PROPERTY DAMAGE.

This document and other information from Parker Hannifin Corporation, its subsidiaries and authorized distributors provide product or system options for further investigation by users having technical expertise.

The user, through its own analysis and testing, is solely responsible for making the final selection of the system and components and assuring that all performance, endurance, maintenance, safety and warning requirements of the application are met. The user must analyze all aspects of the application, follow applicable industry standards, and follow the information concerning the product in the current product catalog and in any other materials provided from Parker or its subsidiaries or authorized distributors.

To the extent that Parker or its subsidiaries or authorized distributors provide component or system options based upon data or specifications provided by the user, the user is responsible for determining that such data and specifications are suitable and sufficient for all applications and reasonably foreseeable uses of the components or systems.

### OFFER OF SALE

The items described in this document are hereby offered for sale by Parker Hannifin Corporation, its subsidiaries or its authorized distributor. This offer and its acceptance are governed by the provisions stated in the detailed Parker Hannifin "Offer of Sale".

# EM Sales Offices

## Australia

**Parker Hannifin (Australia) Pty Ltd.**  
9 Carrington Road  
Castle Hill NSW 2154  
Australia  
Tel: +61 (0) 2 9634-7777  
Fax: +61 (0) 2 9634 3749

## Brazil

**Parker Hannifin Ind. Com Ltda.**  
Av. Lucas Nogueira Garcez 2181  
Esperança  
12325-900 Jacareí, SP  
Tel: 12 3954 5100  
Fax: 12 3954 5262  
Email: automation.brazil@parker.com

## Canada

**Parker Hannifin (Canada) Inc.**  
160 Chisholm Dr  
Milton, Ontario L9T 3G9  
Tel: 905-693-3000  
Fax: 905-876-1958  
Email: miltoncustservice@parker.com

## China

**Parker Hannifin Motion & Control**  
(Shanghai) Co., Ltd  
280 Yunqiao Rd. Jin Qiao Export  
Processing Zone  
Shanghai 201206, China  
Tel: (86-21) 50312525  
Fax: (86-21) 64459717

## France

**Parker Hannifin Manufacturing**  
**France SAS**  
4 Boulevard Eiffel  
CS 40090  
21604 Longvic  
France  
Tel +33 (0) 3 80 42 41 40  
Fax +33 (0) 3 80 42 41 30

## Germany

**Electromechanical Europe**  
**Parker Hannifin GmbH & Co KG**  
Robert-Bosch-Strasse 22  
D-77656 Offenburg  
Germany  
Tel: +49 (0) 781 509 0  
Fax: +49 (0) 781 509 98176  
Email: em-motion@parker.com

## India

**Parker Hannifin India Pvt. Ltd**  
**Automation Group-SSD Drives Div.**  
133 & 151 Developed Plots Estate  
Perungudi, Chennai 600 096  
Tel: 044-4391-0799  
Fax: 044-4391-0700

## Italy

**Parker Hannifin SpA**  
Via Gounod 1  
20092 Cinsello Balsamo  
Milano, Italy  
Tel: +39 02 361081  
Fax: +39 02 36108400  
Email: em-motion@parker.com

## Korea

**Parker Hannifin Korea**  
9th Floor KAMCO Yangjae Tower  
949-3 Dogok 1-dong Gangnam-gu  
Seoul 135-860, Korea  
Tel: 82-2-559-0454  
Fax: 82-2-556-8187

## Mexico

**Parker Hannifin de Mexico**  
Eje uno Norte No.100  
Parque Industrial Toluca 2000  
Toluca, CP 50100 México  
Tel: 52-722-275-4200  
Fax: 52-722-279-0316

## Singapore

**Parker Hannifin Singapore Pte Ltd**  
11, Fourth Chin Bee Road  
Singapore 619702  
Tel: (65) 6887 6300  
Fax: (65) 6265 5125/6261 4929

## Taiwan

**Parker Hannifin Taiwan Co., Ltd**  
No. 40, Wuchiuan 3rd Road  
Wuku Industrial Park  
Taipei County, Taiwan 248  
ROC  
Tel: 886 2 2298 8987  
Fax: 886 2 2298 8982

## Thailand

**Parker Hannifin (Thailand) Co., Ltd.**  
1265 Rama 9 Road  
Suanluang, Bangkok 10250  
Thailand  
Tel: (66) 2 186 7000  
Fax: (66) 2 374 1645

## UK

**Parker Hannifin Ltd.**  
Tachbrook Park Drive  
Tachbrook Park  
Warwick CV34 6TU  
Tel: +44 (0) 1926 317970  
Fax: +44 (0) 1926 317980

## USA

**Parker Hannifin Electromechanical**  
**& Drives Division Main Office**  
9225 Forsyth Park Drive  
Charlotte NC 28273 USA  
Tel: (704) 588-3246  
800-358-9070  
Fax: (704) 588-3249  
Email: emn\_support@parker.com

**Parker Hannifin Electromechanical**  
**Automation Division**  
1140 Sandy Hill Road  
Irwin, PA 15642 USA  
Tel: (724) 861-8200  
800-245-6903  
Fax: (724) 861-3330  
Email: emn\_support@parker.com

**Parker Hannifin Electromechanical**  
**Motor and Gearhead Business Unit**  
2101 North Broadway  
New Ulm, Minnesota 56073 USA  
Tel: (507) 354-1616  
800-358-9070  
Fax: (507) 233-2390  
Email: emn\_support@parker.com

**Parker Hannifin Electronics**  
**Business Unit**  
5500 Business Park Drive  
Rohnert Park, CA 94928 USA  
Tel: (707) 584-7558  
800-358-9070  
Fax: (707) 584-8015  
Email: emn\_support@parker.com

**Parker Hannifin T-Slot Aluminum**  
**Framing and Guarding (IPS)**  
135 Quadral Drive  
Wadsworth, OH 44281 USA  
Tel: (330) 334-3335  
800-358-9070  
Fax: (330) 334-2350  
Email: emn\_support@parker.com

