



ASME Code Filter Vessels

Compressed Air & Gas Filtration

aerospace
climate control
electromechanical
filtration
fluid & gas handling
hydraulics
pneumatics
process control
sealing & shielding



ENGINEERING YOUR SUCCESS.

www.comoso.com

Large Capacity ASME Vessels

Finite's filter vessels eliminate oil, water, and particulate contamination from large flows of compressed air and gas.



Finite Filter's large capacity ASME filter vessels have been designed specifically for our coalescing elements and incorporate large sump capacities and generous exit cavities for maximum performance with low differential pressures.

All units are "U" stamped and conform to ASME Section VIII standard code for pressure vessels. With flow capacities to 37,000 SCFM and optional materials of construction, most compressor source filtration requirements can be met.



Standard Specifications

- Porting to: 16" Flange
- Flows to: 37,000 SCFM (63,000 m³/hr)
- Design: ASME Code/CRN (Canadian Registration)
- Max. Temp: 450°F
- Max. Pressure: 185 PSIG
- Filter Media: Coalescing, Particulate, Vapor Adsorption, and Bulk Liquid Removal
- Configuration: Floor-Standing or Line-Mounted
- Drain and Vent Ports: 1/2" NPT
- Design allows for easy element changeout

Typical Applications

Coalescing (Oil Removal)	Interceptor (Particulate Removal)	Adsorber (Vapor Removal)
Compressed air system protection	Natural gas inlet systems	Odor removal
Dryer protection - Mist eliminator	Desiccant dryer afterfilter	Food packaging
Paint spray booths	Prefilter for coalescer	Powder paint systems
Microelectronics quality air prefiltration	Systems with high particulate concentration	Blow molding
Landfill gas	Particulate protection for non-lubricated systems	Breathing air
Natural gas treatment		

We do Specials

Call our technical department at 1-800-521-4357 to ask about our custom ASME vessels.

Custom options include:

- Stainless steel vessels (304 & 316 SS options)
- High pressure
- Corrosion allowance
- Non-standard port orientation
- Sight glass ports
- Custom name plates
- Liquid level control connections
- P.E.D. Compliant

Compressed Air Standards and Applications

ISO 8573-1 is an international standard that has become the universally accepted method for specifying and testing the purity of compressed air. ISO 8573-1 specifies a purity “class” based on contaminants in compressed air. There are three classes that describe

1) particulate contamination concentration, 2) liquid or vaporous water contamination concentration, and 3) the contamination concentration caused by oil in the liquid, aerosol, and vapor states. The ISO purity class is always stated using three numbers in a

definite order: the solid particulate class, followed by the water contamination class, and finally the oil contamination class. Use the table below to see how the purity classes for each contaminant type are defined.

Notification as specified in ISO 8573-1

Class	Solid		Water		Oil		
	Maximum Particle Size	Maximum Concentration		Maximum Pressure Dew point		Maximum Concentration	
	µm	ppm	(mg/m ³)	°F	(°C)	ppm	(mg/m ³)
1	0.1	0.08	(0.1)	-94	(-70)	0.008	(0.01)
2	1	0.8	(1)	-40	(-40)	0.08	(0.1)
3	5	4.2	(5)	-4	(-20)	0.83	(1)
4	15	6.7	(8)	37	(+3)	4.2	(5)
5	40	8.3	(10)	45	(+7)	21	(25)
6	-	-	-	50	(+10)	-	-

Typical Applications

ISO Class 2 Solid 3 Water 3 Oil

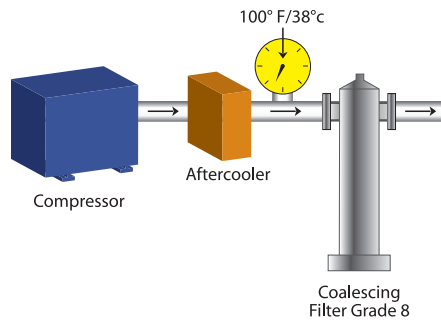

ISO Class 1 Solid 4 Water 1 Oil

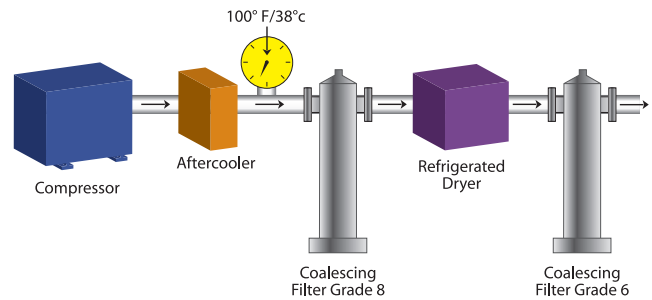

ISO Class 2 Solid 4 Water 3 Oil

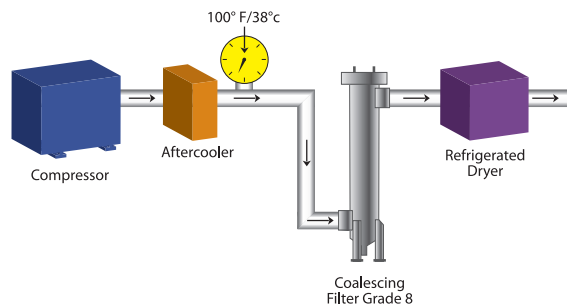

ISO Class 1 Solid 2 Water 1 Oil

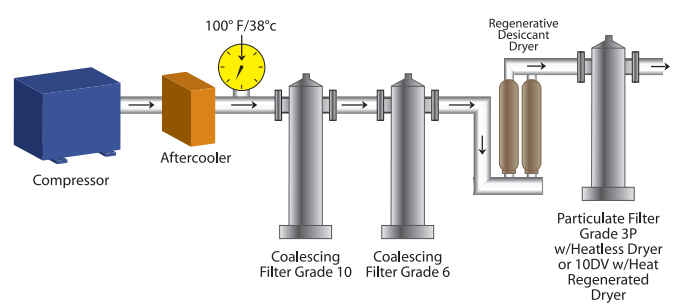

Note: In the pictorial examples shown above, the contribution of hydrocarbon vapors has not been taken into account in determining the oil class category.

Determine your application, media grade, media type and end seals.

Find your (or similar) application from the descriptions below, from the basic application circuits on the previous page, or consult a Finite application engineer. Determine media grade, media type, and end seal required. If your application requires a coalescing element, use the information listed below. For other media types, please see the following page.

Coalescing Elements (removal of liquids and particulate)

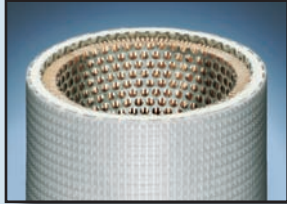

Media type C or Q

Available in grades 6, 8 or 10
Air Flow: Inside to Outside

This coalescing element is composed of an epoxy saturated, borosilicate glass micro-fiber tube. Type Q has a pleated cellulose inner layer as a built-in prefilter. This element is metal retained for added strength, and includes a synthetic fabric layer to aid in draining liquids away from the coalescing layer.

Media type Q is shown here. Media type C has the same coalescing outer layer, without the inner pleated layer.

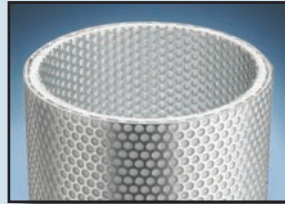

Media type D

Available in grades 6, 8 or 10
Air Flow: Inside to Outside

The type D element is composed of a binderless micro-glass coalescer layer surrounded by two metal retainers. These metal retainers, coupled with a glass drain layer and an outer perforated metal handling layer, make this a robust element designed to handle high temperatures.

This element is typically used as a high temperature coalescer, or the particulate afterfilter for a heated regenerative desiccant dryer.



Media type ME

Air Flow: Inside to Outside

Finite's Mist Eliminator (ME) media consists of two filtration layers pleated together. The outer layer consists of a dense matrix of glass fibers. This coalescing layer provides highly efficient aerosol removal and very low pressure drop. The inner layer effectively traps dirt particles, protecting and extending the life of the outer layer. This element is metal retained for added strength, and includes a synthetic fabric layer to aid in draining liquids away from the coalescing layer.

The Finite ME element maintains its high efficiency rating even at low flow rates, allowing the user to specify Finite housings that are oversized for the application, greatly extending the life of the element. Due to the stainless steel components used in the ME element, it is ideally suited for long life service or corrosive environments.

Type ME elements are great prefilters for all types of air dryers. This element maintains dryer efficiency by removing oil before it damages costly desiccant or membranes. It also protects refrigerated dryers by preventing coating of coils with oil or varnish.



Media type 7CVP

Air Flow: Inside to Outside

Finite's 7CVP media consists of two layers. The outer layer consists of a dense matrix of glass fibers. This coalescing layer provides highly efficient aerosol removal and very low pressure drop. The inner layer effectively traps dirt particles, protecting and extending the life of the outer layer. This element is metal retained for added strength, and includes a synthetic fabric layer to aid in draining liquids away from the coalescing layer.

This media is used in bulk coalescing applications and when relatively high efficiency and low pressure drop are required.

Type 7CVP elements are great prefilters for refrigerated air dryers, where low differential pressure is a requirement. This element maintains dryer efficiency by preventing the coating of heat exchanger coils with oil and varnish.

For a high temperature version of this element, specify type 7DVP.

For types C, Q and D... Choose your grade...

Grade 6 filters are used when "total removal of liquid aerosols and suspended fines" is required. Because of its overall performance characteristics, this grade is most often recommended.

A grade 6 element is great prefilter protection for desiccant air dryers. This element prevents oil or varnish from coating the desiccant, while maintaining the dryer efficiency.

Grade 8 filters combine high efficiency with high flow rate and long element life. A separate prefilter is not required for "normal to light" particulate loading.

A grade 8 element is great prefilter protection for refrigerated air dryers. This element maintains dryer efficiency by preventing coating of coils with oil or varnish.

Grade 10 filters are used as prefilters for grades 6 or 8 to remove gross amounts of liquid aerosols or tenacious aerosols which are difficult to drain. This grade is often referred to as a coarse coalescer.

A grade 10 element coupled with media type D is a recommended afterfilter for heat regenerated type dryers.

Water Separator Element
(removal of bulk liquids)

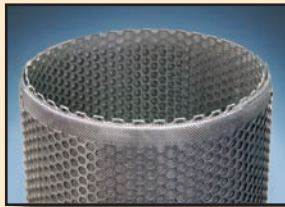

Media type 100WS

Air Flow: Inside to Outside

This all stainless steel mesh element has two metal retainers with rolled mesh steel in between. It is an extremely robust design.

This media is used for the reduction and elimination of excess liquids in gas streams. Excellent prefiltration for coalescing grades 6 and 10 when extreme quantities of liquid contaminants are present.

Interceptor Element
(removal of particulate)

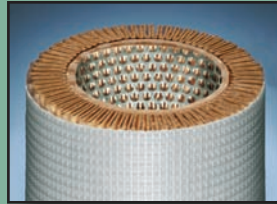

Media type 3P

Air Flow: Outside to Inside

This particulate element is constructed of pleated cellulose with a 3 micron rating. It is metal retained for added strength and includes an outer handling layer.

3P particulate interceptor elements are used where high dirt holding capacity and relatively fine pore structure are required.

Adsorption Element
(removal of odor)

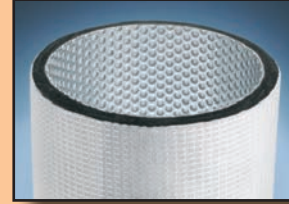

Media type A

Air Flow: Outside to Inside

This hydrocarbon vapor removal element consists of an ultrafine grained, highly concentrated, activated carbon sheet media. It is metal retained for added strength and includes an outer synthetic fabric layer.

Finite Media Specifications

Grade Designation	Coalescing Efficiency 0.3 to 0.6 Micron Particles	Maximum Oil Carryover ¹ PPM w/w	Micron Rating	Pressure Drop (PSID) @ Rated Flow ²	
				Media Dry	Media Wet With 10-20 wt. oil
6	99.97%	0.008	0.01	1.5	4.0
ME	99.95%	0.02	0.3	0.5	1.0
7	99.5%	0.09	0.5	0.25	0.5
8	98.5%	0.2	0.5	1.0	3.5
10	95%	0.85	1.0	0.75	2.5
100WS	N/A	N/A	100	<0.25	<0.50
3P	N/A	N/A	3.0	0.25	N/A
A	99%+ ³	N/A	N/A	1	N/A

¹Tested per ADF-400 at 40 ppm inlet.

²Add dry + wet for total pressure drop.

³Oil vapor removal efficiency is given for A media.

End Seals available:

End Seals	Available on Media type:	Max temp of element with end seal
U: Molded Urethane (standard)	C	225°F (107°C)
	Q	
	3P	
S: Molded Silicone Rubber	C	350°F (177°C)
	Q	350°F (177°C)
	D	450°F (232°C)
	3P	350°F (177°C)
V: Fluorocarbon gaskets on metal end caps	C	350°F (177°C)
	Q	350°F (177°C)
	D	450°F (232°C)
	ME	225°F (107°C)
	7CVP	225°F (107°C)
	7DVP	400°F (204°C)
	100WS	350°F (177°C)
	3P	350°F (177°C)
	A	225°F (107°C)

Housing Selection Chart

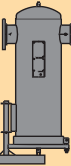
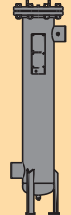
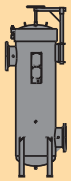
Housing Assembly Number	Replacement Element Number	Port Size (Inches)	Port Type	Number of Elements	Rated Flows: SCFM@ 100 PSIG (m ³ hr@ 7 bar)			
					Grade 6/A	Grade 8	Grade ME/7CVP/10/100WS/3P	
Line-Mount Vessels								
	HT3-801	51-280	3	NPT	1	1500 (2540)	1800 (3050)	2490 (4230)
	FT3-801	51-280	3	FLANGE	1	1500 (2540)	1800 (3050)	2490 (4230)
	FT4-1201	85-250	4	FLANGE	1	2000 (3390)	2400 (4070)	3320 (5640)
	FT6-1201	85-360	6	FLANGE	1	3000 (5090)	3600 (6110)	4980 (8460)
	FT6-1603	51-280	6	FLANGE	3	4500 (7640)	5400 (9170)	7470 (12690)
Floor-Standing Vessels								
	HF3-801	51-280	3	NPT	1	1500 (2540)	1800 (3050)	2490 (4230)
	FF3-801	51-280	3	FLANGE	1	1500 (2540)	1800 (3050)	2490 (4230)
	FF4-1201	85-250	4	FLANGE	1	2000 (3390)	2400 (4070)	3320 (5640)
	FF6-1201	85-360	6	FLANGE	1	3000 (5090)	3600 (6110)	4980 (8460)
	FF6-1603	51-280	6	FLANGE	3	4500 (7640)	5400 (9170)	7470 (12690)
	FF8-1804	51-280	8	FLANGE	4	6000 (10190)	7200 (12230)	9960 (16920)
	FF10-2207	51-280	10	FLANGE	7	10500 (17830)	12600 (21400)	17430 (29610)
	FF12-3011	51-280	12	FLANGE	11	16500 (28030)	19800 (33640)	27390 (46530)
	FF16-3615	51-280	16	FLANGE	15	22500 (38220)	27000 (45870)	37350 (63450)

How to Order

Complete Assembly*:

Housing Assembly Number (from chart above)	-	Media Grade	Media Type	End Seals
Examples: FF3-801-6QU FF6-1603-7CVP		6	C	U - Urethane can be used for media types: C, Q, and 3P.
		8	Q	
		10	D	
		Note: Only add media grade for C, Q & D	ME	S - Silicone rubber can be used for media types C, Q, D, and 3P.
			7CVP 7DVP	
		100WS 3P A	V - Fluorocarbon can be used on C, Q, D, 3P. Standard on ME, 7CVP, 7DVP, 100WS, and A.	

See pages 4-5 for more information on media grades, types, and end seals.

*complete assembly includes vessel and elements. Elements are shipped separately from vessel.

How to order replacement elements:

1. Choose the media grade, type, and end seals that you need.
2. Look in the Housing Selection Chart above and find the respective Replacement Element Number.
3. Put 1 & 2 together. For example: 6QU51-280 or 7CVP85-250.

Drawings, Dimensions & Specifications

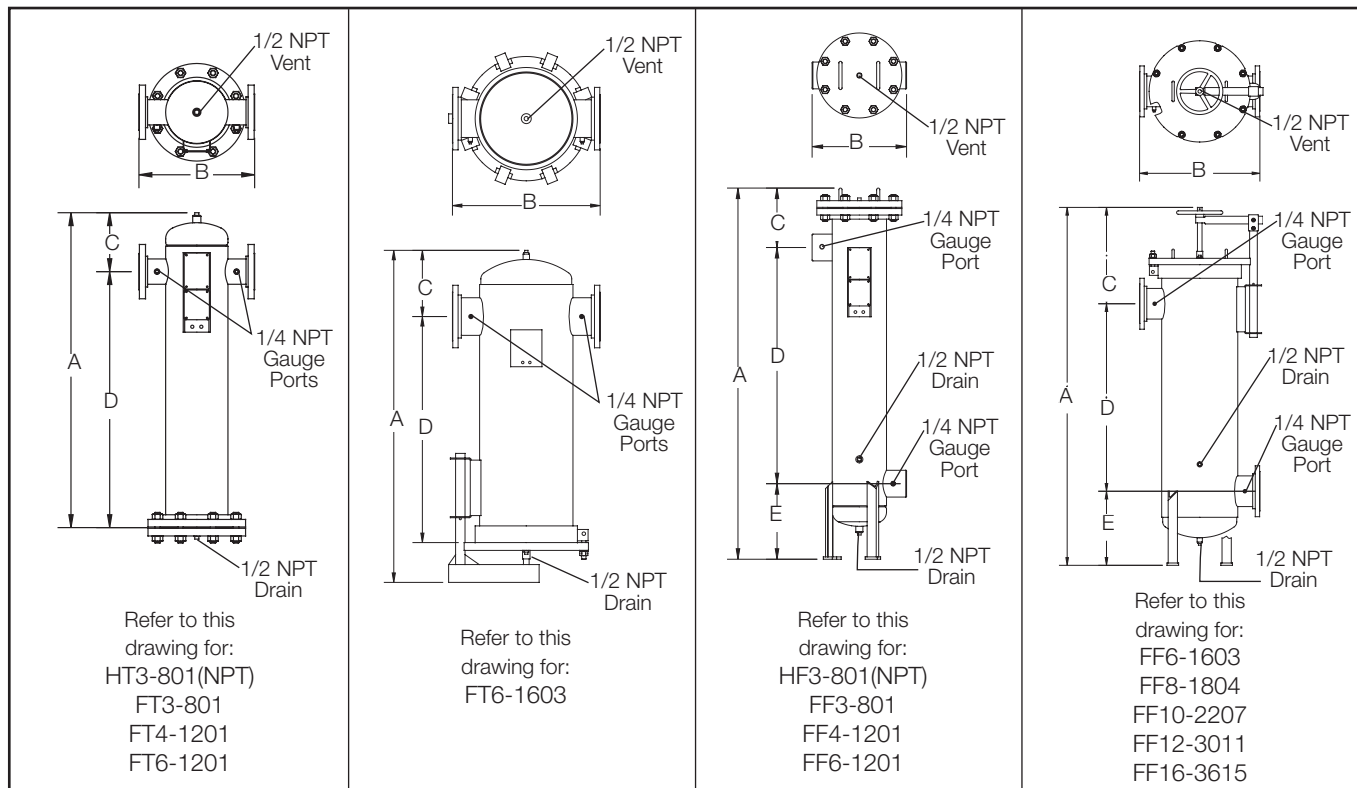

Dimension ¹	A	B	C	D	E	Element Removal Clearance	Sump Capacity ²	Weight ³
HT3-801	43.1 (109.5)	15.0 (38.1)	7.7 (19.5)	35.4 (89.9)		28 (71.1)	0.81 (3)	190 (86)
FT3-801	43.1 (109.5)	16.0 (40.6)	7.7 (19.5)	35.4 (89.9)		28 (71.1)	0.81 (3)	190 (86)
FT4-1201	42.7 (108.5)	20.0 (50.8)	9.7 (24.6)	33.0 (83.8)		25 (63.5)	2.0 (7)	380 (173)
FT6-1201	56.4 (143.3)	20.0 (50.8)	11.4 (29.0)	45.0 (114.3)		36 (91.4)	2.0 (7)	380 (173)
FT6-1603	57.8 (146.8)	26.0 (66.0)	11.0 (27.9)	39.8 (101.1)		28 (71.1)	2.0 (7)	340 (155)
HF3-801	58.9 (149.6)	15.0 (38.1)	9.4 (23.8)	37.5 (95.2)	12.0 (30.4)	28 (71.1)	1.1 (4)	190 (86)
FF3-801	58.9 (149.6)	16.0 (40.6)	9.4 (23.8)	37.5 (95.2)	12.0 (30.4)	28 (71.1)	1.2 (4)	200 (91)
FF4-1201	63.3 (160.7)	20.0 (50.8)	12.3 (31.2)	35.0 (88.9)	16.0 (40.6)	25 (63.5)	4.2 (16)	370 (168)
FF6-1201	75.3 (191.2)	20.0 (50.8)	12.3 (31.2)	47.0 (119.3)	16.0 (40.6)	36 (91.4)	3.6 (14)	410 (186)
FF6-1603	77.3 (196.3)	26.0 (66.0)	20.8 (52.8)	40.5 (102.8)	16.0 (40.6)	28 (71.1)	5.0 (19)	340 (155)
FF8-1804	87.3 (221.7)	30.0 (76.2)	25.8 (65.5)	42.5 (108.0)	19.0 (48.3)	28 (71.1)	8.7 (33)	550 (250)
FF10-2207	96.0 (243.8)	34.0 (86.3)	28.5 (72.4)	45.5 (115.5)	22.0 (55.8)	28 (71.1)	14.8 (56)	750 (341)
FF12-3011	101.0 (256.5)	44.0 (111.7)	27.5 (69.8)	47.5 (120.6)	26.0 (66.0)	28 (71.1)	25.5 (97)	1300 (591)
FF16-3615	112.0 (284)	52.0 (132.0)	32.0 (81.3)	50.0 (127.0)	30.0 (76.2)	28 (71.1)	56.2 (231)	1700 (773)

¹Dimensions are in inches (centimeters.) ²Sump Capacity is in gallons (liters.) ³Weight is in pounds (kilograms.)

Materials of Construction

Body: Carbon Steel
Paint: Epoxy Enamel (Gray)
Internals: Epoxy powder painted carbon steel
Seals: Inorganic flange gasket (single element vessels)
 Fluorocarbon o-ring (multi element vessels)
Internal Coating: Epoxy enamel

Specifications

Max Pressure: 185 PSIG (12.5 bar)
Max Temperature: 450°F (232°C)

Meets A.S.M.E. Code, Section VIII, Division 1
 Note: Consult factory for special requirements.

Accessories

Gauges

Differential pressure gauges indicate pressure loss through the filter. As the filter element becomes loaded with contamination, differential pressure rises. Changing out the clogged filter element is usually more economical than continued operation at elevated pressures (6-8 PSID).

KBDPG-15

Differential Pressure Gauge Kit

- Kit includes gauge, 1/8" and 1/4" NPT brass fittings, flexible nylon tubing, and mounting bracket.



Temp: 200°F (93°C)
Pressure: 250 PSIG (17 bar)

KBDPI-25

Differential Pressure Gauge Kit

- Kit includes gauge, 1/8" and 1/4" NPT brass fittings, flexible nylon tubing, and mounting bracket.



Temp: 200°F (93°C)
Pressure: 250 PSIG (17 bar)

Drains

Finite offers several choices of automatic drains, ranging from simple float actuated drains, programmable solenoid types, and smart zero-air loss drains, which conserve energy by only draining when liquid is present.

ADT-50

Float Actuated Drain Trap

- 1/2" NPT Inlet Connection
- 1/4" NPT Outlet Connection



Temp: 450°F (232°C)
Pressure: Max=289 PSIG (20 bar); Min=15 PSIG (1 bar)

ZLD-023

Zero Air Loss Condensate Drain

- 1/2" NPT Connection
- Electrical connection = 115 vAC
- Other Models Available



Temp: 35° - 140°F (2° - 60°C)
Pressure: 3 - 232 PSIG (0.2 - 16 bar)

TV-50

Timed Solenoid Valve Drain Trap

- 1/2" NPT Connection
- Electrical connection = 110 vAC
- Other Models Available



Temp: 210°F (99°C)
Pressure: 300 PSIG (20 bar)

ADS-50

Float Actuated Stainless Steel Drain Trap

- 304 stainless steel construction
- 1/2" NPT Inlet and Outlet Connections



Temp: 450°F (232°C)
Pressure: 400 PSIG (28 bar)

Note: Accessories are sold separately from the ASME vessels.



Parker Hannifin Corporation
Finite Filter Operation
 500 S Glaspie Street
 Oxford, MI 48371
 phone 248 628 6400
 fax 248 628 1850
 www.parker.com/finitefilter

© 2009 Parker Hannifin Corporation
 Bulletin 1300-400/USA