



aerospace
climate control
electromechanical
filtration
fluid & gas handling
hydraulics
pneumatics
process control
sealing & shielding



Viking Valve Series

Air Control Valves & Accessories

Catalog 0697P



ENGINEERING YOUR SUCCESS.

 **WARNING**

FAILURE OR IMPROPER SELECTION OR IMPROPER USE OF THE PRODUCTS AND/OR SYSTEMS DESCRIBED HEREIN OR RELATED ITEMS CAN CAUSE DEATH, PERSONAL INJURY AND PROPERTY DAMAGE.

This document and other information from Parker Hannifin Corporation, its subsidiaries and authorized distributors provide product and/or system options for further investigation by users having technical expertise. It is important that you analyze all aspects of your application including consequences of any failure, and review the information concerning the product or system in the current product catalog. Due to the variety of operating conditions and applications for these products or systems, the user, through its own analysis and testing, is solely responsible for making the final selection of the products and systems and assuring that all performance, safety and warning requirements of the application are met.

The products described herein, including without limitation, product features, specifications, designs, availability and pricing, are subject to change by Parker Hannifin Corporation and its subsidiaries at any time without notice.

Offer of Sale

The items described in this document are hereby offered for sale by Parker Hannifin Corporation, its subsidiaries or its authorized distributors. This offer and its acceptance are governed by the provisions stated on the separate page of this document entitled "Offer of Sale".

© Copyright 2013 Parker Hannifin Corporation. All Rights Reserved



Parker Hannifin Corporation
Pneumatic Division
Richland, Michigan
www.parker.com/pneumatics

Viking Lite Series Valves

The Viking Lite Series pneumatic valve range is a robust, versatile valve which combines high performance with compact installation dimensions. Large flow capacity, short change-over times and low change-over pressure are important characteristics of the valve range.

WCS

- Maximum Performance
 - Low friction - fast response - less wear
- Long Cycle Life
 - Under pressure, radial expansion of the seal occurs to maintain sealing contact with the valve bore
- Non-Lube Service
 - No lubrication required for continuous valve shifting
- Bi-Directional Spool Seals
 - Common spool used for any pressure

WCS
Wear Compensation System

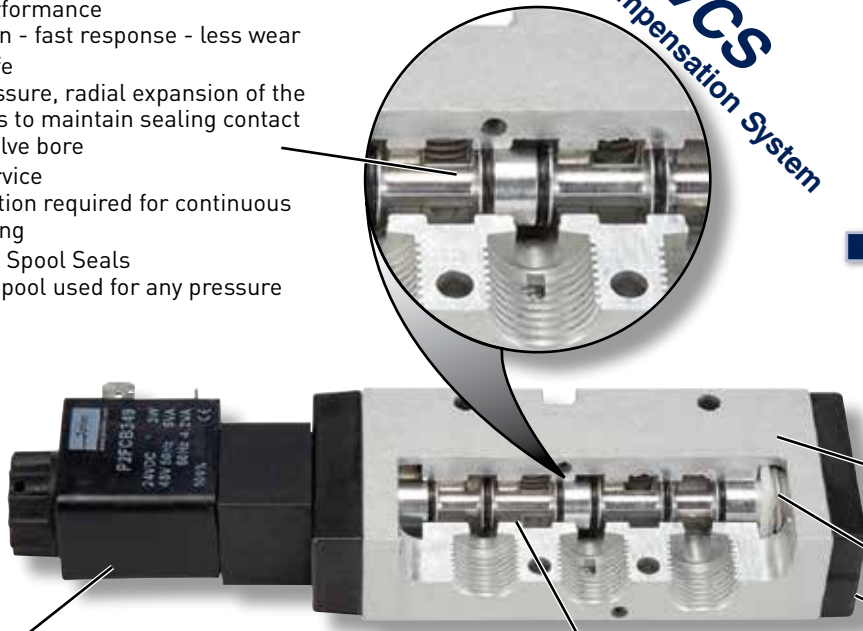
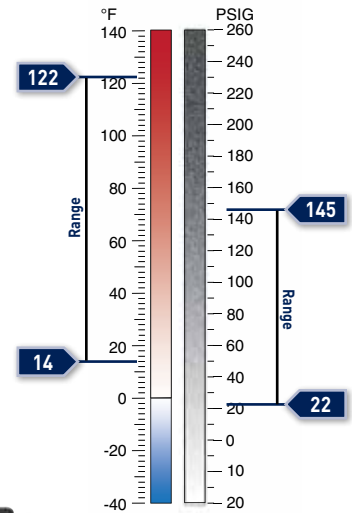

- Solenoid operated, IP65, RoHS, CE
- 90° rotation

The bore is polished to a very high surface finish for maximum flow capacity and long life.

Robust anodized aluminum valve body

Stainless steel spring return

Diecast end covers with zinc plated screws.

Valve options: Viking Lite

- 3-way, 2-position
- Single solenoid
- Spring return
- Double solenoid



- 4-way, 2-position
- Single solenoid
- Spring return
- Double solenoid



- 4-way, 3-position
 - Center exhaust
 - Pressure center
 - Blocked center



Valve port options

- 1/8, 1/4 & 3/8 inch NPT & BSP threads.

Solenoid options

- 22-pin, DIN



Manifold options

- IEM bar manifold kits



Lite Markets



Industrial



Automotive



Food Processing



Industrial



Industrial



Industrial



Viking Xtreme Valve

The Viking Xtreme Valve Series is robust, versatile valve, incorporating stainless steel fasteners and over molded spool for large flow capacity, short change-over times and low change-over pressures. Viking Xtreme Valve Series has 2 different valve ranges: Viking XTREME Valve and Viking NORMAL Valve. These valves have *standard* and *unique* features which enables the designer to choose the best valve for the varying applications ranging from General Industrial to the more rugged environments.

Over molded Spool

- Aluminum spool with nitrile rubber coating ground to exact size for optimum performance
- Precision ground for maximum performance
- Wide operating temperature range - Low temperature to -40°

- Solenoid operated, IP65, RoHS, CE
- Wide variety of electrical connections
- 90° rotation
- Air pilot available

Robust anodized aluminum valve body

Stainless steel spring return

Diecast end covers with stainless steel screws to resist aggressive environments.

The bore is polished to a very high surface finish for maximum flow capacity and long life.

Sintered bronze pilot chamber breathers provide increased protection against ingress of dust and dirt.

Standard Features

Valve options: Xtreme & Normal versions

- 3-way, 2-position
- Single & double solenoid
- 4-way, 2-position
- Single & double solenoid
- 4-way, 2-position
- 4-way, 3-position
- Center exhaust
- Pressure center
- Blocked center



Valve port options

- 1/8, 1/4, 3/8 & 1/2 inch NPT & BSPP threads.
- NAMUR mount.

Solenoid options: a wide variety of voltages including mobile rated coils with tolerance ranges for mobile applications

- 22-pin, DIN
- Grommet
- 30mm Square
- 1/2" Conduit



Manifold options

- IEM bar manifold kits



Viking Xtreme Valve

Unique Features

In addition to the common features, the unique features in the Xtreme and Normal Valves enable the designer to fit these valves into applications where standard valves will not meet the specifications.

Viking Xtreme Valve: Normal Version

- **Temperature range: 14°F to 122°F (-10°C to 50°C)**
- **Pressure range: Vacuum to 145 PSIG (10 bar)**
- **Override options**
 - No-override
 - Flush - locking
 - Extended - non-locking
- **Standard solenoid armature**
- **Unique solenoids: Viking Normal**
 - Hazardous duty Class I; Groups A, B, C & D
 - Class II; Groups E, F, & G
 - Class III; Div. I
 - Intrinsically safe Class I; Groups A, B, C & D
 - Class II; Groups E, F, & G
 - Class III; Div. I
 - ATEX approved solenoids

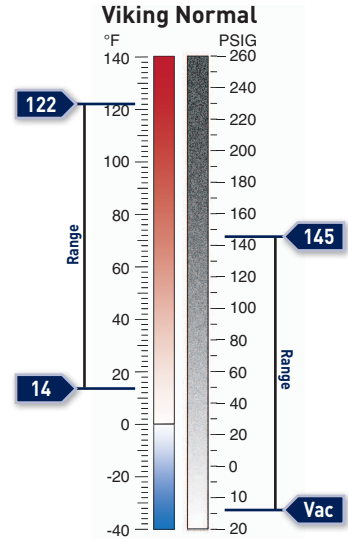

General Markets



Viking Xtreme Valve: Xtreme Version

- **Wider temperature range: -40°F to 140°F (-40°C to 60°C)**
- **Wider pressure range: Vacuum to 232 PSIG (16 bar)**
- **Tested to +5g shock & vibration**
- **Passed 500 hour salt spray test**
- **Override options**
 - No-override
 - Extended - non-locking
- **Stainless steel solenoid armature**
 - Improved corrosion resistance for harsh environments
 - Extends operating temperature and pressure range
- **Unique valve configurations: Viking Xtreme**
 - Remote pilot
 - All 3-way & 4-way combinations
 - 2 & 3-position

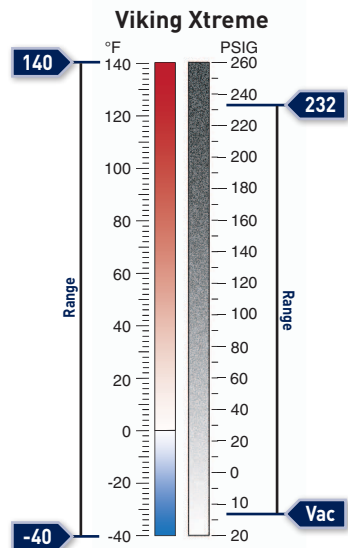
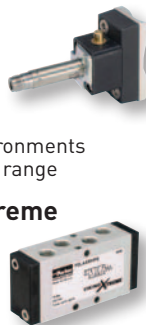

Xtreme Markets



Viking Xtreme Manual Valve

Viking Xtreme Manual Valves have all the features of the Viking Xtreme Valves including temperature and pressure range while incorporating a rugged lever actuator which has been specifically designed for gloved hands to suit mobile applications in the most arduous of environments.

- Wide variety of manual actuators
- Robust Knobs
- Stainless steel available
- Handle boots for ingress protection

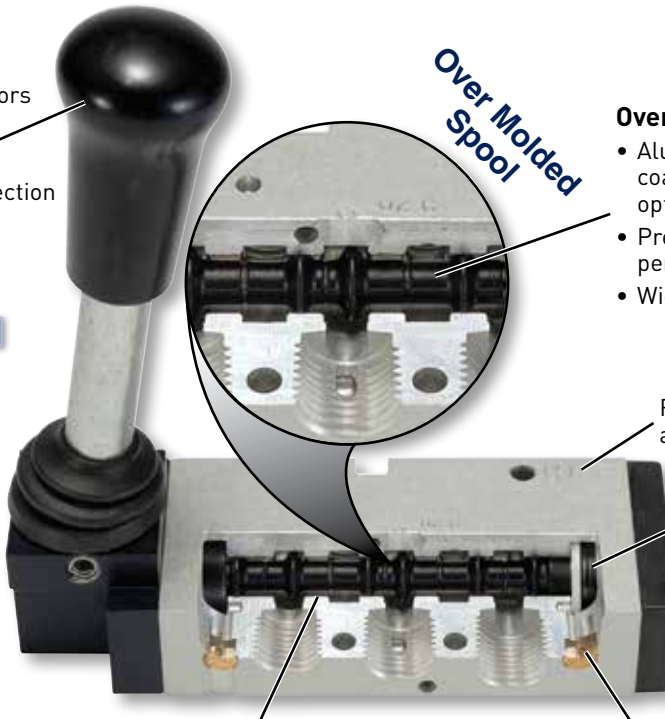
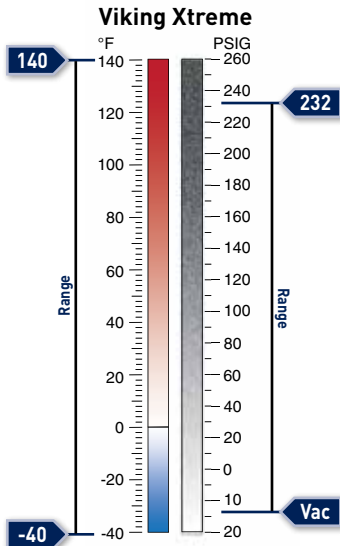

Over molded Spool

- Aluminum spool with nitrile rubber coating ground to exact size for optimum performance
- Precision ground for maximum performance
- Wide operating temperature range - Low temperature to -40°

Robust anodized aluminum valve body

Stainless steel spring return

Diecast end covers with stainless steel screws to resist aggressive environments.

The bore is polished to a very high surface finish for maximum flow capacity and long life.

Sintered bronze pilot chamber breathers provide increased protection against ingress of dust and dirt.

Valve options

- 3-way, 2-position valves
 - Spring return
 - Detent



- 4-way, 2-position valves
 - Spring return
 - Detent



- 4-way, 3-position valves
 - Center exhaust
 - Pressure center
 - Blocked center



Valve port options

- 1/8, 1/4, 3/8 & 1/2 inch NPT & BSPP threads.

Handle Options

- Light Weight, Low Profile Lever 1/8" valve size, 5/2 & 5/3 only



- Twist Knob with Panel Nut 1/4" body, 4-way, 2-position only



- Rugged, Stainless Steel Shafted Handle Valve



Xtreme Markets



Rail



Agri-Food



Forestry



Road



Industrial



Oil & Gas



Viking Lite Series Valves.....	3
Basic Valve Functions.....	1-2
Basic Valve Features.....	3
Solenoid Common Part Numbers.....	4-5
Solenoid Valve Model Number Index	5
IEM Bar Manifolds & Accessories	6
Dimensions	7-10
Viking Xtreme Series Valves.....	11
Basic Valve Functions.....	1-2
Basic Valve Features.....	11
Normal Operating Pressure / Temperature Common Solenoid Part Numbers	12-13
Xtreme Operation Pressure / Temperature Common Solenoid Part Numbers	14-15
Solenoid Valve Model Number Index	16
Remote Air Pilot Common Part Numbers	17
Remote Air Pilot Model Number Index.....	17
ATEX Complete Valve & Solenoid Pilot Assemblies	18
IEM Bar Manifolds & Accessories	19
22mm Solenoid Pilot Operators & Coils.....	20
Pilot Operator & Solenoid Kits.....	21-22
Viking Xtreme Series internal / External Pilot Conversion.....	22
Technical Data.....	23
Accessories, Repair Kits.....	24-25
Dimensions	26-34
Viking Xtreme Manual Valves.....	35
Basic Valve Functions.....	2
Basic Valve Features.....	35
Manual Operated Valves Common Part Numbers	36-37
Manual Operated Valve Model Number Index	37
Accessories.....	38
Dimensions	39-41
DOT Fittings	42-43
Valve Technical Information.....	44
Fluid Power Graphic Symbols	45
Safety Guide.....	46-47
Offer of Sale	48

Single solenoid

3-Way, 2-Position NC (NNP)

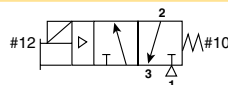

Normally Closed:

De-energized position – Solenoid #12 de-energized. Pressure at inlet port 1 blocked, outlet port 2 connected to exhaust port 3.

Energized position – Solenoid #12 energized. Pressure at inlet port 1 connected to outlet port 2, exhaust port 3 is blocked.

Double solenoid

3-Way, 2-Position

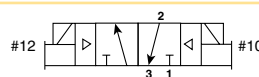

Solenoid operator #12 energized last. Pressure at inlet port 1 connected to outlet port 2, exhaust port 3 is blocked.

Solenoid operator #10 energized last. Pressure at inlet port 1 blocked, outlet port 2 connected to exhaust port 3.

Single remote pilot

3-Way, 2-Position NC (NNP)

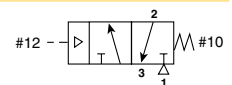

Normally Closed:

Normal position – Pressure at inlet port 1 blocked, outlet port 2 connected to exhaust port 3.

Operated position – Maintained air signal at port 12. Pressure at inlet port 1 connected to outlet port 2, exhaust port 3 is blocked.

Double solenoid

3-Way, 2-Position

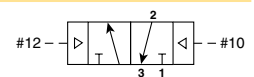

Momentary air signal at port 12 last. Pressure at inlet port 1 connected to outlet port 2, exhaust port 3 is blocked.

Momentary air signal at port 10 last. Pressure at inlet port 1 blocked, outlet port 2 connected to exhaust port 3.



Single solenoid

Single pressure at inlet port 1:

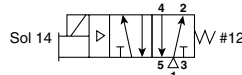

De-energized position – Solenoid operator #14 de-energized. Pressure at inlet port 1 connected to outlet port 2. Outlet port 4 connected to exhaust port 5.

Energized position – Solenoid operator #14 energized. Pressure at inlet port 1 connected to outlet port 4. Outlet port 2 connected to exhaust port 3.

Double solenoid

Single pressure at inlet port 1:

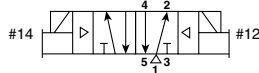

Solenoid operator #14 energized last. Pressure at inlet port 1 connected to outlet port 4. Outlet port 2 connected to exhaust port 3.

Solenoid operator #12 energized last. Pressure at inlet port 1 connected to outlet port 2. Outlet port 4 connected to exhaust port 5.

Double solenoid 3-position

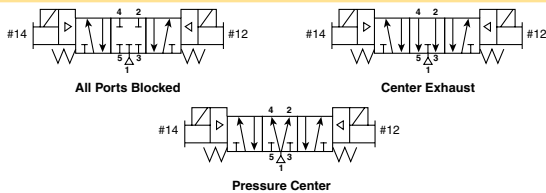

With #12 operator energized – inlet port 1 connected to cylinder port 2, cylinder port 4 connected to exhaust port 5.

With #14 operator energized – inlet port 1 connected to cylinder port 4, cylinder port 2 connected to exhaust port 3.

All Ports Blocked

All ports blocked in the center position.

Center Exhaust

Cylinder ports 2 and 4 connected to exhaust ports 3 and 5 in center position. Port 1 is blocked.

Pressure Center

Pressure port 1 connected to cylinder ports 2 and 4, and exhaust ports 3 and 5 blocked in center position.

Lever Valves

2-position, spring return

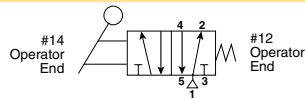

Single pressure at Port #1 – The Hand Lever alternately pressurizes port 2 or 4 while exhausting at port 3 or 5. When actuating Hand Lever, port 4 is pressurized; when releasing Hand Lever, spring returns the spool, pressurizing port 2.

Dual pressure – Pressure at port 3 & 5 alternately pressurizes port 2 or 4 while exhausting at port 1. When actuating Hand Lever, port 2 is pressurized; when releasing Hand Lever, spring returns the spool, pressurizing port 4. (Must be ordered as dual pressure)

2-position, detent

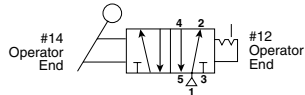

Single pressure at Port #1 – The Hand Lever alternately pressurizes port 2 or 4 while exhausting at port 3 or 5. When pulling Hand Lever, port 4 is pressurized; when pushing Hand Lever, port 2 is pressurized. Spool stays in last actuated position.

Dual pressure – Pressure at port 3 & 5 alternately pressurizes port 2 or 4 while exhausting at port 1. When pulling Hand Lever, port 2 is pressurized; when pushing Hand Lever, port 4 is pressurized. Spool stays in last actuated position. (Must be ordered as dual pressure.)

Single remote pilot

Single pressure at inlet port 1:

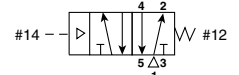

Normal position – Pressure at inlet port 1 connected to outlet port 2. Outlet port 4 connected to exhaust port 5.

Operated position – Maintained air signal at port 14. Pressure at inlet port 1 connected to outlet port 4. Outlet port 2 connected to exhaust port 3.

Double remote pilot

Single pressure at inlet port 1:

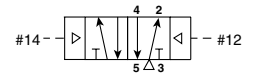

Momentary air signal at port 14 last. Pressure at inlet port 1 connected to outlet port 4. Outlet port 2 connected to exhaust port 3.

Momentary air signal at port 12 last. Pressure at inlet port 1 connected to outlet port 2. Outlet port 4 connected to exhaust port 5.

Double remote pilot 3-position

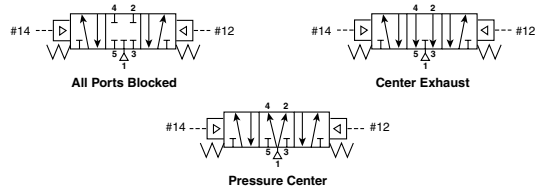

With #12 operator signaled – inlet port 1 connected to cylinder port 2, cylinder port 4 connected to exhaust port 5.

With #14 operator signaled – inlet port 1 connected to cylinder port 4, cylinder port 2 connected to exhaust port 3.

All Ports Blocked

All ports blocked in the center position.

Center Exhaust

Cylinder ports 2 and 4 connected to exhaust ports 3 and 5 in center position. Port 1 is blocked.

Pressure Center

Pressure port 1 connected to cylinder ports 2 and 4, and exhaust ports 3 and 5 blocked in center position.

3-position, detent

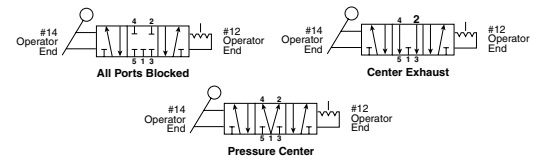

Single pressure at Port #1 – The Hand Lever alternately pressurizes port 2 or 4 while exhausting at port 3 or 5.

When pulling Hand Lever, port 4 is pressurized; when pushing Hand Lever, port 2 is pressurized. When Hand Lever is vertical, it is in the center position - either APB or CE. Spool stays in last actuated position.

Center functions

All ports blocked, detent & spring center

Center exhaust, detent & spring center

Pressure center, detent & spring center



Parker Pneumatic

The Viking Lite valve range is robust, versatile and combines a large flow capacity with short change-over times, designer may choose 1/8, 1/4 or 3/8 port sizes along with 24VDC and 120VAC voltage options. Viking Lite valves are fitted with dynamic bi-directional spool seals suitable for pressures up to 10 bar and ambient temperatures between -10°C to +50°C. When in service, radial expansion of the spool seal occurs to maintain sealing contact with the valve bore. This sealing method reduces friction and produces a lower required pilot pressure. Valves do not require lubrication in operation but they can also be installed in systems that are lubricated.

Ports

- P2LAZ: 1/8 inch NPT & BSPP, Cv = 0.6
- P2LBZ: 1/4 inch NPT & BSPP, Cv = 1.5
- P2LCZ: 3/8 inch NPT & BSPP, Cv = 2.5

Mounting

- Inline
- IEM aluminum bar

Solenoids

2.5 watts
 - 22mm, 3-pin (DIN 43650)
 24VDC and 120VAC

Certification / approval

- IP65 Rated, RoHS, CE

Materials

Valve body	Anodized aluminium
End covers	Anodized aluminium
Spool	Aluminium
Piston	Acetal plastic / Anodized aluminium
End cover sealings	Nitrile rubber
End cover screws	Zinc plated steel
Springs	Stainless steel
Mounting screws for solenoid	Stainless steel
Spool seals	Nitrile

Features

WCS

- Maximum Performance
 - Low friction - fast response - less wear
- Long Cycle Life
 - Under pressure, radial expansion of the seal occurs to maintain sealing contact with the valve bore
- Non-Lube Service
 - No lubrication required for continuous valve shifting
- Bi-Directional Spool Seals
 - Common spool used for any pressure
- Solenoid operated, IP65, RoHS, CE
- 90° rotation

The bore is polished to a very high surface finish for maximum flow capacity and long life.

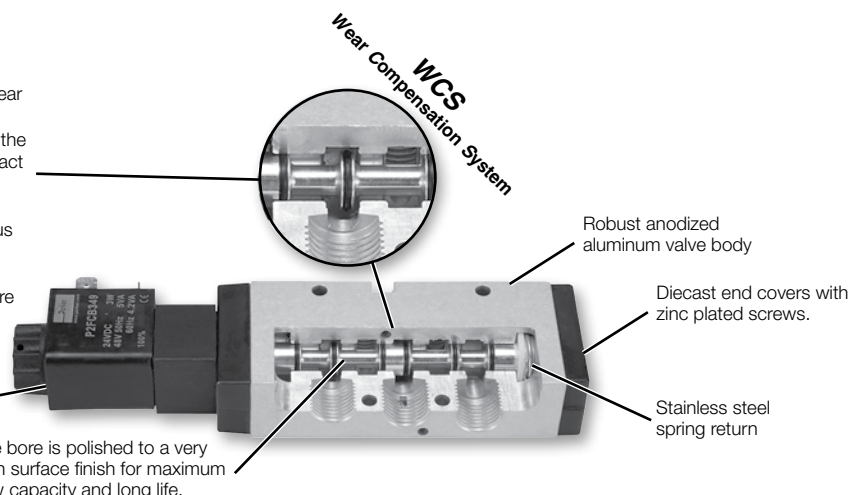

Viking Lite Series Valves Air Control Valves

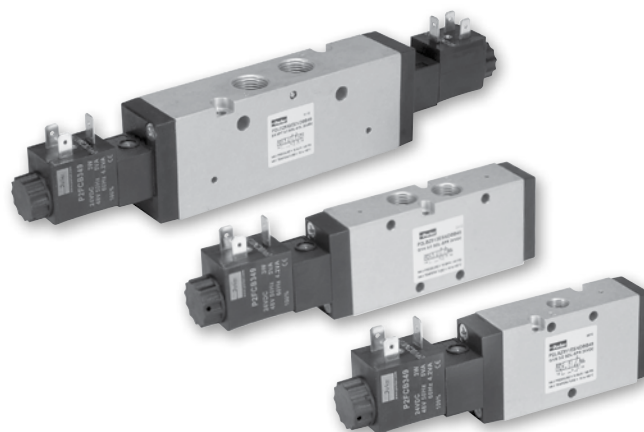

Operating information

Operating pressure:	145 PSIG (10 bar)
Minimum:	See chart
Operating temperature:	14°F to 122°F (-10°C to 50°C)

Minimum operating pressure, PSIG (bar)

Valve type - Internal pilot	P2LAZ	P2LBZ	P2LCZ
Single solenoid - spring return	43.5 (3.0)	43.5 (3.0)	43.5 (3.0)
Double solenoid - 2-position	22 (1.5)	22 (1.5)	22 (1.5)
Double solenoid - 3-position (APB, PC, CE)	43.5 (3.0)	43.5 (3.0)	43.5 (3.0)

Recommended air quality for valves

For best possible service life and trouble free operation, ISO 8573-1 quality class 3.4.3 should be used. This means 5µm filter (standard filter) dew point +3°C for indoor operation (a lower dew point should be selected for outdoor operation) and oil concentration 1.0 mg oil/m³, which is what a standard compressor with a standard filter gives.

3/2 - 2 Position Single Solenoid

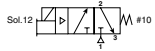

P2LAZ Shown

Port size	Cv	Response time (msec)	Weight lb (kg)	Voltage	Part number (NPT)	Part number (BSPP)
1/8	0.6	15 / 35	0.35 (0.16)	24VDC	P2LAZ391ESNDBB49	P2LAZ311ESNDBB49
				120VAC	P2LAZ391ESNDBB53	P2LAZ311ESNDBB53
1/4	1.5	18 / 45	0.35 (0.16)	24VDC	P2LBZ392ESNDBB49	P2LBZ312ESNDBB49
				120VAC	P2LBZ392ESNDBB53	P2LBZ312ESNDBB53
3/8	2.5	27 / 45	0.77 (0.35)	24VDC	P2LCZ393ESNDBB49	P2LCZ313ESNDBB49
				120VAC	P2LCZ393ESNDBB53	P2LCZ313ESNDBB53

3/2 - 2 Position Double Solenoid

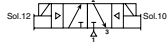

P2LAZ Shown

Port size	Cv	Response time (msec)	Weight lb (kg)	Voltage	Part number (NPT)	Part number (BSPP)
1/8	0.6	10 / 10	0.40 (0.18)	24VDC	P2LAZ391EENDBB49	P2LAZ311EENDBB49
				120VAC	P2LAZ391EENDBB53	P2LAZ311EENDBB53
1/4	1.5	12 / 12	0.40 (0.18)	24VDC	P2LBZ392EENDBB49	P2LBZ312EENDBB49
				120VAC	P2LBZ392EENDBB53	P2LBZ312EENDBB53
3/8	2.5	17 / 17	0.80 (0.36)	24VDC	P2LCZ393EENDBB49	P2LCZ313EENDBB49
				120VAC	P2LCZ393EENDBB53	P2LCZ313EENDBB53

5/2 - 2 Position Single Solenoid

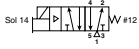

P2LAZ Shown

Port size	Cv	Response time (msec)	Weight lb (kg)	Voltage	Part number (NPT)	Part number (BSPP)
1/8	0.6	15 / 35	.037 (0.17)	24VDC	P2LAZ591ESNDBB49	P2LAZ511ESNDBB49
				120VAC	P2LAZ591ESNDBB53	P2LAZ511ESNDBB53
1/4	1.5	18 / 45	0.44 (0.20)	24VDC	P2LBZ592ESNDBB49	P2LBZ512ESNDBB49
				120VAC	P2LBZ592ESNDBB53	P2LBZ512ESNDBB53
3/8	2.5	27 / 45	0.95 (0.43)	24VDC	P2LCZ593ESNDBB49	P2LCZ513ESNDBB49
				120VAC	P2LCZ593ESNDBB53	P2LCZ513ESNDBB53

5/2 - 2 Position Double Solenoid

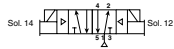

P2LAZ Shown

Port size	Cv	Response time (msec)	Weight lb (kg)	Voltage	Part number (NPT)	Part number (BSPP)
1/8	0.6	10 / 10	.042 (0.19)	24VDC	P2LAZ591EENDBB49	P2LAZ511EENDBB49
				120VAC	P2LAZ591EENDBB53	P2LAZ511EENDBB53
1/4	1.5	12 / 12	0.46 (0.21)	24VDC	P2LBZ592EENDBB49	P2LBZ512EENDBB49
				120VAC	P2LBZ592EENDBB53	P2LBZ512EENDBB53
3/8	2.5	17 / 17	0.97 (0.44)	24VDC	P2LCZ593EENDBB49	P2LCZ513EENDBB49
				120VAC	P2LCZ593EENDBB53	P2LCZ513EENDBB53

5/3 - 3 Position, All Ports Blocked

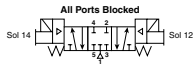

P2LAZ Shown

Port size	Cv	Response time (msec)	Weight lb (kg)	Voltage	Part number (NPT)	Part number (BSPP)
1/8	0.6	18 / 40	0.57 (0.26)	24VDC	P2LAZ691EENDBB49	P2LAZ611EENDBB49
				120VAC	P2LAZ691EENDBB53	P2LAZ611EENDBB53
1/4	1.5	22 / 55	0.62 (0.28)	24VDC	P2LBZ692EENDBB49	P2LBZ612EENDBB49
				120VAC	P2LBZ692EENDBB53	P2LBZ612EENDBB53
3/8	2.5	30 / 90	1.32 (0.60)	24VDC	P2LCZ693EENDBB49	P2LCZ613EENDBB49
				120VAC	P2LCZ693EENDBB53	P2LCZ613EENDBB53

Most popular. **Notes:** Response time: Actuate to 90% pressure / return to exhaust to 10% of supply pressure. 93 PSIG (6.3 bar) / temperature 68°F (20°C)



5/3 - 3 Position, Pressure Center

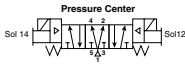

P2LAZ Shown

Port size	Cv	Response time (msec)	Weight lb (kg)	Voltage	Part number (NPT)	Part number (BSPP)
1/8	0.6	18 / 40	0.57 (0.26)	24VDC	P2LAZ791EENDBB49	P2LAZ711EENDBB49
				120VAC	P2LAZ791EENDBB53	P2LAZ711EENDBB53
1/4	1.5	22 / 55	0.62 (0.28)	24VDC	P2LBZ792EENDBB49	P2LBZ712EENDBB49
				120VAC	P2LBZ792EENDBB53	P2LBZ712EENDBB53
3/8	2.5	30 / 90	1.32 (0.60)	24VDC	P2LCZ793EENDBB49	P2LCZ713EENDBB49
				120VAC	P2LCZ793EENDCB53	P2LCZ713EENDBB53

5/3 - 3 Position, Center Exhaust

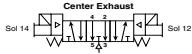

P2LAZ Shown

Port size	Cv	Response time (msec)	Weight lb (kg)	Voltage	Part number (NPT)	Part number (BSPP)
1/8	0.6	18 / 40	0.57 (0.26)	24VDC	P2LAZ891EENDBB49	P2LAZ811EENDBB49
				120VAC	P2LAZ891EENDBB53	P2LAZ811EENDBB53
1/4	1.5	22 / 55	0.62 (0.28)	24VDC	P2LBZ892EENDBB49	P2LBZ812EENDBB49
				120VAC	P2LBZ892EENDBB53	P2LBZ812EENDBB53
3/8	2.5	30 / 90	1.32 (0.60)	24VDC	P2LCZ893EENDBB49	P2LCZ813EENDBB49
				120VAC	P2LCZ893EENDBB53	P2LCZ813EENDBB53

Notes: Response time: Actuate to 90% pressure / return to exhaust to 10% of supply pressure. 93 PSIG (6.3 bar) / temperature 68°F (20°C)

Single & Double Solenoid Operated Valves

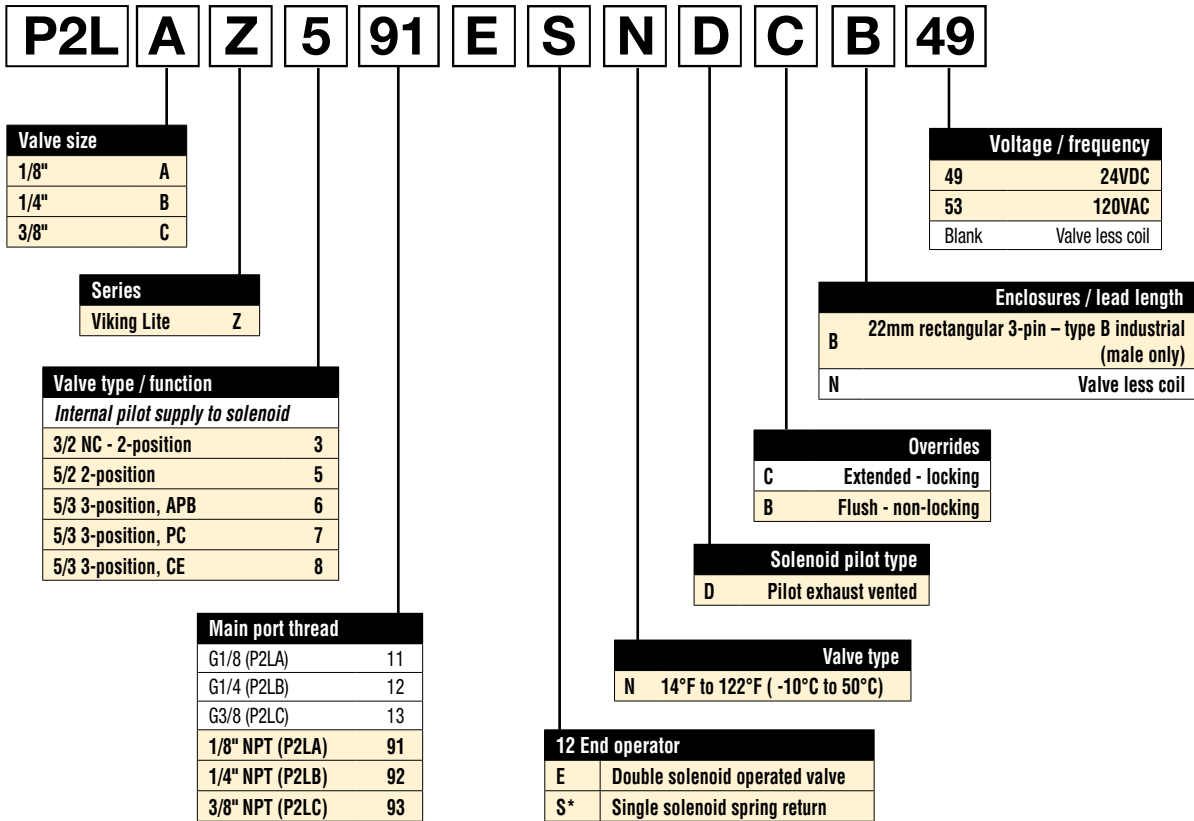

* Not available with 3-position valves.

Most popular.



IEM Bar Manifold, Inline Valve Only*



Valve series	Valve function	# of Stations	Weight lb (kg)	Manifold only (NPT)	Manifold only (BSPP)
P2LAZ / P2LBZ	3-way	2	0.84 (0.38)	91213202SXZN	91213202SXZ
P2LAZ / P2LBZ	3-way	4	1.41 (0.64)	91213204SXZN	91213204SXZ
P2LAZ / P2LBZ	3-way	6	1.96 (0.89)	91213206SXZN	91213206SXZ
P2LAZ / P2LBZ	3-way	8	2.54 (1.15)	91213208SXZN	91213208SXZ
P2LAZ / P2LBZ	3-way	10	3.09 (1.40)	91213210SXZN	91213210SXZ

Kits include: Manifold, valve hold down bolts, gaskets.



Valve series	Valve function	# of Stations	Weight lb (kg)	Manifold only (NPT)	Manifold only (BSPP)
P2LAZ	4-way	2	0.68 (0.31)	9121658068N	9121658068
P2LAZ	4-way	4	1.06 (0.48)	9121658075N	9121658075
P2LAZ	4-way	6	1.39 (0.63)	9121658076N	9121658076
P2LAZ	4-way	8	1.76 (0.80)	9121658077N	9121658077
P2LAZ	4-way	10	2.16 (0.98)	9121658078N	9121658078

Kits include: Manifold, valve hold down bolts, gaskets.



Valve series	Valve function	# of Stations	Weight lb (kg)	Manifold only (NPT)	Manifold only (BSPP)
P2LBZ	4-way	2	1.53 (0.69)	9121594805XN	9121594805X
P2LBZ	4-way	4	2.49 (1.13)	9121594806XN	9121594806X
P2LBZ	4-way	6	3.44 (1.56)	9121594807XN	9121594807X
P2LBZ	4-way	8	4.41 (2.00)	9121594808XN	9121594808X
P2LBZ	4-way	10	5.40 (2.45)	9121594812XN	9121594812X

Kits include: Manifold, valve hold down bolts, gaskets.

* For odd number of stations, consider Viking Xtreme bar manifold.

IEM Bar Manifold, Inline Valve Only



Valve series	Valve function	# of Stations	Manifold only (NPT)	Manifold only (BSPP)
P2LCZ	4-way	Use Viking Xtreme IEM bar manifold		

Note: P2LCZ 3-way has no IEM manifold

Manifold Accessories / Parts



Valve series	Description	Weight lb (kg)	Kit number
P2LAZ / P2LBZ *	3-way: Blanking kit with mounting screws (2)	0.22 (0.10)	912132BPSXZ
P2LAZ *	4-way: Blanking kit with mounting screws (2)	0.11 (0.05)	9121658063
P2LBZ *	4-way: Blanking kit with mounting screws (2)	0.04 (0.02)	9121594809X

***Note:** O-ring for blanking kit included with manifold. For replacement o-rings or fastener bolts, use Viking Xtreme Kits.

22mm Rectangular 3-Pin – Type B Industrial (Use with Enclosure “B”)

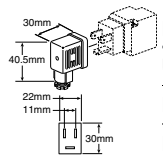

Description	Connector with 6' (2m) cord	Connector
Unlighted	PS2429JBP	PS2429BP
Light – 24VDC	PS2430J79BP*	PS243079BP
Light – 120V/60Hz	PS2430J83BP*	PS243083BP

* LED with surge suppression.

Note: Max ø6.5mm cable size required for connector w/o 6' (2m) cord.
IP65 rated when properly installed.

Engineering data:

conductors: 2 poles plus ground; cable range (connector only): 6 to 8mm (0.24 To 0.31 Inch); contact spacing: 11mm

Most popular.

Valve Less Coil

Remove the last 3 digits of the part number of the full valve and add “N” at the end for valve less coil.



Part number example :
P2LBZ592ESNDBBB49
valve with 24VDC solenoid
P2LBZ592ESNDBN valve less coil

Replacement Solenoid Coil



Description
24VDC coil kit
110VAC coil kit

Part number
P2FCB449
P2FCB453

Replacement Solenoid Nut



Description
Solenoid diffuser nut



Description
Solenoid vented nut

P2LAZ 3/2 Single & Double Operators – Solenoid

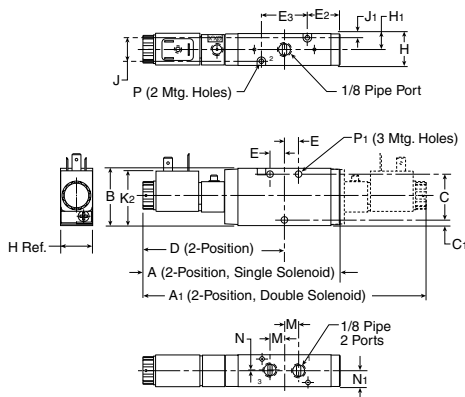

P2LAZ 3/2 (solenoid)

A 5.35 (136)	A1 7.68 (195)	B 1.57 (40)	C 1.26 (32)	C1 .16 (4)
D 3.84 (97.5)	E .39 (10)	E2 .91 (23)	E3 1.26 (32)	H .87 (22)
H1 .43 (11)	J .65 (16.5)	J1 .11 (2.75)	K2 1.50 (38)	M .39 (10)
N .02 (.5)	N1 .43 (11)	P Ø .12 Ø (3.1)	P1 Ø .17 Ø (4.3)	

Inches (mm)

P2LAZ 3/2 Single & Double Operators – IEM Aluminum Bar Manifold

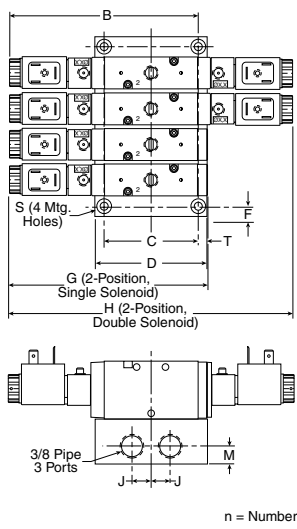

Number of valves	X
2	2.91 (74)
4	4.80 (122)
6	6.69 (170)
8	8.58 (218)
10	10.47 (266)
Inches (mm)	

Manifold bolt	Torque value
M3x40 SHCS	4 in.lb (0.45 Nm)

**P2LAZ 3/2
IEM Aluminum bar manifold**

B 5.06 (128.5)	C 2.44 (62)	D 2.99 (76)	F .28 (7)	G 5.35 (136)
H 7.68 (195)	J .51 (13)	K 2.78 (70.5)	L 1.20 (30.5)	M .47 (12)
P .94 (24)	Q 1.42 (36)	R 1.97 (50)	S Ø .22 Ø (5.5)	T .88 (7)

Inches (mm)

P2LAZ 5/2 & 5/3 Single & Double Operators – Solenoid

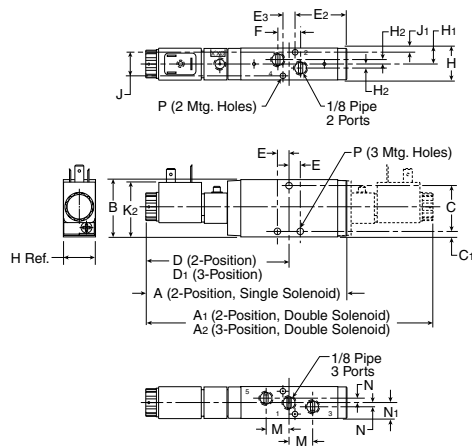

P2LAZ 5/2 & 5/3 (solenoid)

A 5.47 (139)	A1 7.76 (197)	A2 8.70 (221)	B 1.57 (40)	C 1.30 (33)
C1 .14 (3.5)	D 3.88 (98.5)	D1 4.35 (110.5)	E .31 (8)	E2 1.86 (47.3)
E3 .33 (8.5)	F .63 (16)	H .87 (22)	H1 .43 (11)	H2 .12 (3)
J .63 (16)	J1 .12 (3)	K2 1.50 (38)	M .63 (16)	N .12 (3)
N1 .43 (11)	P Ø .16 Ø (4.1)			

Inches (mm)



P2LAZ 5/2 & 5/3 Single & Double Operators – IEM Aluminum Bar Manifold

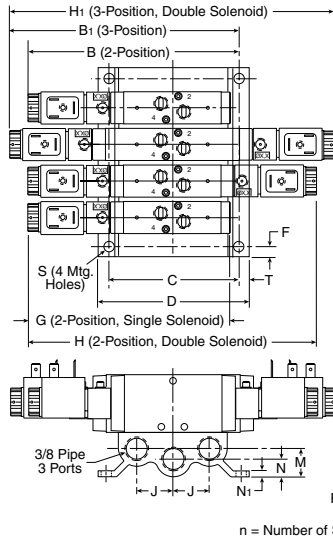

Number of valves	X
2	3.07 (78)
4	4.96 (126)
6	6.85 (174)
8	8.74 (222)
10	10.63 (270)
Inches (mm)	

Manifold bolt	Torque value
M4x45 Screw MRX	9 in.lb (0.75 Nm)

P2LAZ 5/2 & 5/3

IEM Aluminum bar manifold

B	B ₁	C	D	F
5.10 (149.5)	6.36 (161.5)	3.46 (88)	4.02 (102)	.28 (7)

G	H	H ₁	J	K
5.47 (139)	7.76 (197)	8.70 (221)	.96 (24.5)	2.76 (70)

L	M	N	N ₁	P
1.18 (30)	.75 (19)	.47 (12)	.16 (4)	.94 (24)

Q	R	S	T
1.57 (40)	2.13 (54)	∅.28 (7)	.28 (7)

Inches (mm)

P2LBZ 3/2 Single & Double Operators – Solenoid

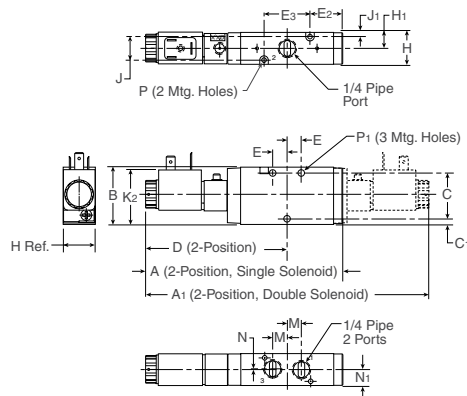

P2LBZ 3/2 (solenoid)

A	A ₁	B	C	C ₁
5.35 (136)	7.68 (195)	1.57 (40)	1.26 (32)	.16 (4)

D	E	E ₂	E ₃	H
3.84 (97.5)	.39 (10)	.91 (23)	1.26 (32)	.87 (22)

H ₁	J	J ₁	K ₂	M
.43 (11)	.65 (16.5)	.11 (2.75)	1.50 (38)	.39 (10)

N	N ₁	P	P ₁
.02 (.5)	.43 (11)	∅.12 (3.1)	∅.17 (4.3)

Inches (mm)

P2LBZ 3/2 Single & Double Operators – IEM Aluminum Bar Manifold

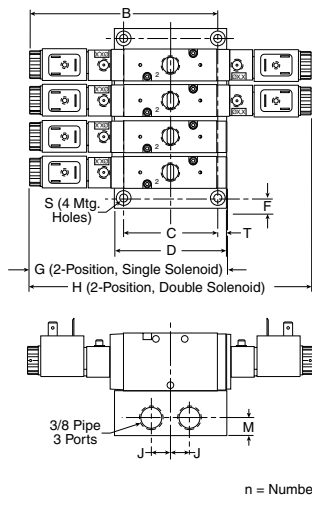

Number of valves	X
2	2.91 (74)
4	4.80 (122)
6	6.69 (170)
8	8.58 (218)
10	10.47 (266)
Inches (mm)	

Manifold bolt	Torque value
M3x40 SCHS	4 in.lb (0.45 Nm)

P2LBZ 3/2

IEM Aluminum bar manifold

B	C	D	F	G
5.06 (128.5)	2.44 (62)	2.99 (76)	.28 (7)	5.35 (136)

H	J	K	L	M
7.68 (195)	.51 (13)	2.78 (70.5)	1.20 (30.5)	.47 (12)

P	Q	R	S	T
.94 (24)	1.42 (36)	1.97 (50)	∅.22 (5.5)	.88 (7)

Inches (mm)

P2LBZ 5/2 & 5/3 Single & Double Operators – Solenoid

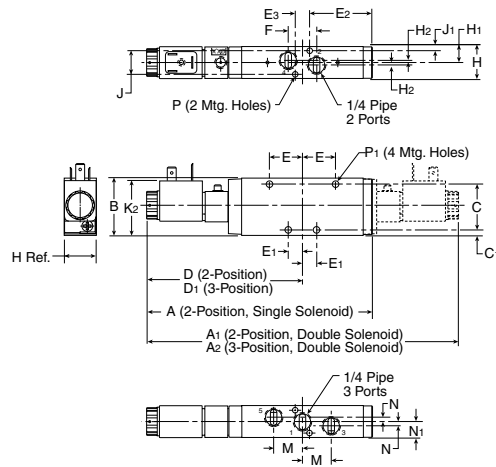

P2LBZ 5/2 & 5/3 (solenoid)

A	A ₁	A ₂	B	C
6.14 (156)	8.46 (215)	9.29 (236)	1.57 (40)	1.26 (32)
C ₁	D	D ₁	E	E ₁
.16 (4)	4.23 (107.5)	4.65 (118)	.91 (23)	.39 (10)
E ₂	E ₃	F	H	H ₁
1.14 (29)	.39 (10)	.79 (20)	.87 (22)	.43 (11)
H ₂	J	J ₁	K ₂	M
.06 (1.5)	.65 (16.5)	.11 (2.8)	1.50 (38)	.79 (20)
N	N ₁	P	P ₁	
.08 (2)	.43 (11)	Ø .12 (3.1)	Ø .17 (4.3)	

Inches (mm)

P2LBZ 5/2 & 5/3 Single & Double Operators – IEM Aluminum Bar Manifold

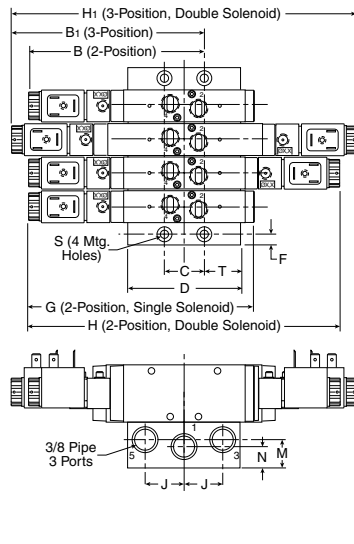

Number of valves	X
2	2.91 (74)
4	4.80 (122)
6	6.69 (170)
8	8.58 (218)
10	10.47 (266)

Inches (mm)

Manifold bolt	Torque value
M3x40 SCHS	9 in.lb (0.75 Nm)

**P2LBZ 5/2 & 5/3
IEM Aluminum bar manifold**

B	B ₁	C	D	F
4.43 (112.5)	4.84 (123)	1.04 (26.5)	2.99 (76)	.28 (7)
G	H	H ₁	J	K
6.14 (156)	8.46 (215)	9.29 (236)	1.02 (26)	2.781 (70.5)
L	M	N	P	Q
1.20 (30.5)	.75 (19)	.57 (14.5)	.94 (24)	1.57 (40)
R	S	T		
1.97 (50)	Ø .22 (5.5)	.97 (25)		

Inches (mm)

P2LCZ 3/2 Single & Double Operators – Solenoid

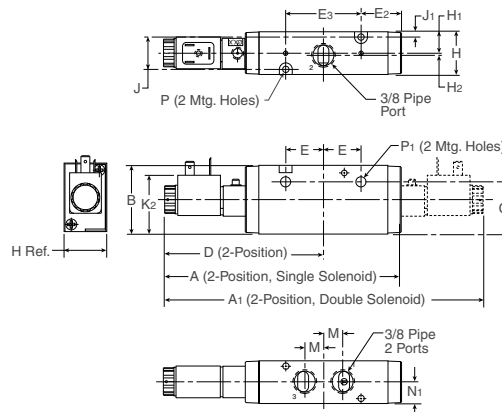

P2LCZ 3/2 (solenoid)

A	A ₁	B	C	D
6.50 (165)	8.66 (220)	1.89 (48)	1.46 (37)	4.33 (110)
E	E ₂	E ₃	H	H ₁
1.04 (26.5)	1.10 (28)	2.09 (53)	1.18 (30)	.59 (15)
H ₂	J	J ₁	K ₂	M
.06 (1.55)	.91 (23)	.14 (3.5)	1.50 (38)	.53 (13.5)
N ₁	P	P ₁		
.59 (15)	Ø .17 (4.4)	Ø .27 (6.9)		

Inches (mm)

Parker Pneumatic

The Viking Xtreme valve range is robust, versatile and combines high performance with compact installation dimensions. Large flow capacity, short change-over times and low change-over pressure are important characteristics of this valve range.

Ports

- P2LAX: 1/8 inch NPT & BSPP
- P2LBX: 1/4 inch NPT & BSPP
- P2LCX: 3/8 inch NPT & BSPP
- P2LDX: 1/2 inch NPT & BSPP

Mounting

- Inline
- IEM aluminum bar

Solenoids

2.5 watts to 7.3 watts

- Conduit
- Grommet
- 22mm & 30mm 3-pin (DIN 43650)

12VDC to 240VAC

Certification / approval

- IP65 Rated, RoHS, CE
- ATEX option available

Mobile applications

- Viking Xtreme tested to +5g shock and vibration
- Solenoids operate with wide voltage tolerance bands
- Corrosion resistant design
- Passed 500 hour salt spray test

Material specifications

Body	Anodized aluminum
End caps	Anodized aluminum
Coils	Thermoplastic
Fasteners	Stainless steel
Spool	Aluminum and nitrile rubber
Springs	Stainless steel

Features

Over Molded Spool

- Aluminum spool with nitrile rubber coating ground to exact size for optimum performance
- Precision ground for maximum performance
- Wide operating temperature range
 - Low temperature to -40°

Diecast end covers with stainless steel screws to resist aggressive environments.

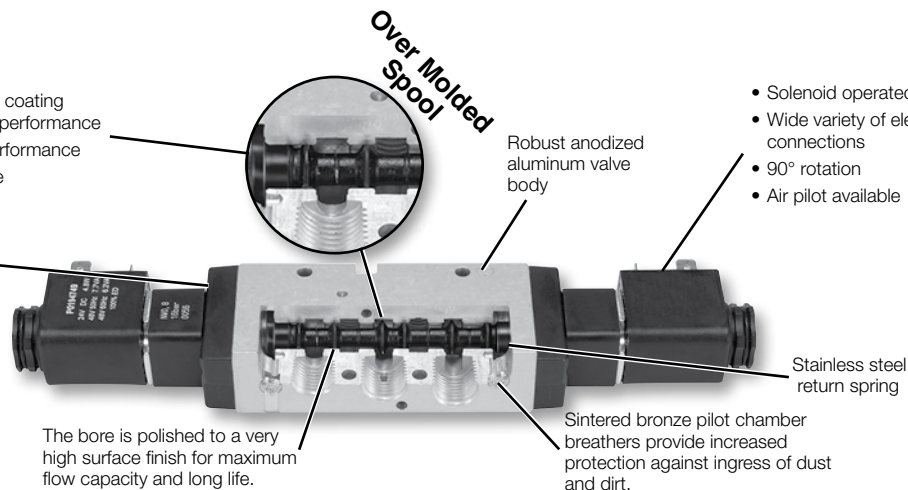

The bore is polished to a very high surface finish for maximum flow capacity and long life.

- Solenoid operated, IP65, RoHS, CE
- Wide variety of electrical connections
- 90° rotation
- Air pilot available

Viking Xtreme Series Valves Air Control Valves

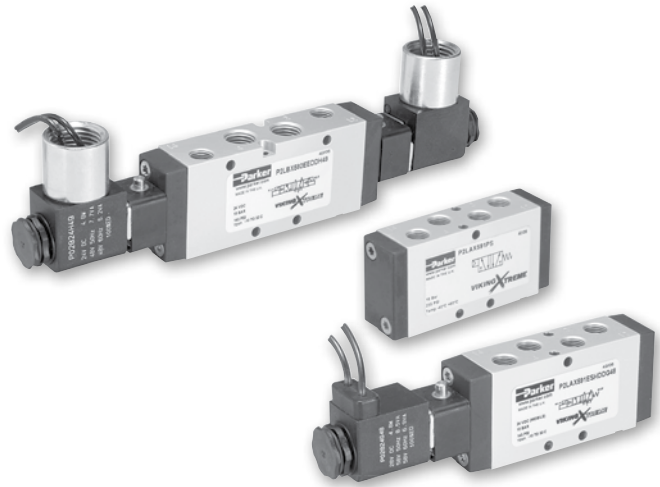

Operating information

Operating pressure:

Normal: Vacuum to 145 PSIG (Vacuum to 10 bar)
 Xtreme: (P2LAX & P2LBX) Vacuum to 232 PSIG (Vacuum to 16 bar)
 (P2LCX & P2LDX) Vacuum to 174 PSIG (Vacuum to 12 bar)

Minimum: See chart



Operating temperature:

Normal: 14°F to 122°F (-10°C to 50°C)
 Xtreme: -40°F to 140°F (-40°C to 60°C)

Minimum operating pressure, PSIG (bar)

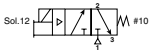

Valve type - Internal pilot	P2LAX	P2LBX	P2LCX	P2LDX
Single solenoid - spring return	46 (3.2)	51 (3.5)	51 (3.5)	51 (3.5)
Single remote pilot - spring return	46 (3.2)	51 (3.5)	51 (3.5)	51 (3.5)
Double solenoid - 2-position	22 (1.5)	22 (1.5)	22 (1.5)	22 (1.5)
Double remote pilot - 2-position	22 (1.5)	22 (1.5)	22 (1.5)	22 (1.5)
Double solenoid - 3-position (APB, PC, CE)	51 (3.5)	51 (3.5)	51 (3.5)	51 (3.5)
Double remote pilot - 3-position (APB, PC, CE)	51 (3.5)	51 (3.5)	51 (3.5)	51 (3.5)

Single Solenoid, 3-way, 2-position, Normal Operating Pressure / Temperature

Solenoid	Port size (NPT)	Cv	Valve type	Response time (msec)	Weight lb (kg)	Voltage	Part number	
  P2LAX 22mm DIN Shown	1/8"	0.7	P2LAX	18 / 40	0.84 (0.38)	24VDC 120VAC	P2LAX391ESNDDDB49 P2LAX391ESNDDDB53	
	1/4"	1.3	P2LBX	18 / 45	0.84 (0.38)	24VDC	P2LBX392ESNDDDB49	
						120VAC	P2LBX392ESNDDDB53	
	3/8"	2.5	P2LCX	25 / 75	1.72 (0.78)	1.72 (0.78)	24VDC	P2LCX393ESNDDDB49
							120VAC	P2LCX393ESNDDDB53
1/2"	2.7	P2LDX	25 / 75	1.72 (0.78)	1.72 (0.78)	24VDC 120VAC	P2LDX394ESNDDDB49 P2LDX394ESNDDDB53	
 P2LAX 18" Grommet Shown	1/8"	0.7	P2LAX	18 / 40	0.84 (0.38)	24VDC 120VAC	P2LAX391ESNDDG49 P2LAX391ESNDDG53	
	1/4"	1.3	P2LBX	18 / 45	0.84 (0.38)	24VDC	P2LBX392ESNDDG49	
						120VAC	P2LBX392ESNDDG53	
	3/8"	2.5	P2LCX	25 / 75	1.72 (0.78)	1.72 (0.78)	24VDC	P2LCX393ESNDDG49
							120VAC	P2LCX393ESNDDG53
1/2"	2.7	P2LDX	25 / 75	1.72 (0.78)	1.72 (0.78)	24VDC 120VAC	P2LDX394ESNDDG49 P2LDX394ESNDDG53	

Notes: Above valves are rated for an operating temperature from 14°F to 122°F (-10°C to 50°C). See model code matrix for additional options.
 Response time: Actuate to 90% pressure / return to exhaust to 10% of supply pressure. 93 PSIG (6.3 bar) / temperature 68°F (20°C).

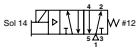
Single Solenoid, 4-way, 2-position, Normal Operating Pressure / Temperature



Solenoid	Port size (NPT)	Cv	Valve type	Response time (msec)	Weight lb (kg)	Voltage	Part number	
  P2LBX 22mm DIN Shown	1/8"	0.7	P2LAX	15 / 35	0.49 (0.22)	24VDC 120VAC	P2LAX591ESNDDDB49 P2LAX591ESNDDDB53	
	1/4"	1.3	P2LBX	18 / 45	0.84 (0.38)	24VDC	P2LBX592ESNDDDB49	
						120VAC	P2LBX592ESNDDDB53	
	3/8"	2.5	P2LCX	27 / 75	1.68 (0.76)	1.68 (0.76)	24VDC	P2LCX593ESNDDDB49
							120VAC	P2LCX593ESNDDDB53
1/2"	2.7	P2LDX	25 / 75	1.68 (0.76)	1.68 (0.76)	24VDC 120VAC	P2LDX594ESNDDDB49 P2LDX594ESNDDDB53	
 P2LAX 18" Grommet Shown	1/8"	0.7	P2LAX	15 / 35	0.49 (0.22)	24VDC 120VAC	P2LAX591ESNDDG49 P2LAX591ESNDDG53	
	1/4"	1.3	P2LBX	18 / 45	0.84 (0.38)	24VDC	P2LBX592ESNDDG49	
						120VAC	P2LBX592ESNDDG53	
	3/8"	2.5	P2LCX	27 / 75	1.68 (0.76)	1.68 (0.76)	24VDC	P2LCX593ESNDDG49
							120VAC	P2LCX593ESNDDG53
1/2"	2.7	P2LDX	25 / 75	1.68 (0.76)	1.68 (0.76)	24VDC 120VAC	P2LDX594ESNDDG49 P2LDX594ESNDDG53	

Notes: Above valves are rated for an operating temperature from 14°F to 122°F (-10°C to 50°C). See model code matrix for additional options.
 Response time: Actuate to 90% pressure / return to exhaust to 10% of supply pressure. 93 PSIG (6.3 bar) / temperature 68°F (20°C).

 Most popular.



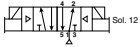

Double Solenoid, 4-way, 2-position, Normal Operating Pressure / Temperature

Solenoid	Port size (NPT)	Cv	Valve type	Response time (msec)	Weight lb (kg)	Voltage	Part number
  22mm DIN P2LBX 22mm DIN Shown	1/8"	0.7	P2LAX	10 / 10	0.60 (0.27)	24VDC 120VAC	P2LAX591EENDDDB49 P2LAX591EENDDDB53
	1/4"	1.3	P2LBX	12 / 12	0.93 (0.42)	24VDC 120VAC	P2LBX592EENDDDB49 P2LBX592EENDDDB53
	3/8"	2.5	P2LCX	17 / 17	1.78 (0.81)	24VDC 120VAC	P2LCX593EENDDDB49 P2LCX593EENDDDB53
	1/2"	2.7	P2LDX	17 / 17	1.78 (0.81)	24VDC 120VAC	P2LDX594EENDDDB49 P2LDX594EENDDDB53
 18" Grommet P2LAX 18" Grommet Shown	1/8"	0.7	P2LAX	10 / 10	0.60 (0.27)	24VDC 120VAC	P2LAX591EENDDG49 P2LAX591EENDDG53
	1/4"	1.3	P2LBX	12 / 12	0.93 (0.42)	24VDC 120VAC	P2LBX592EENDDG49 P2LBX592EENDDG53
	3/8"	2.5	P2LCX	17 / 17	1.78 (0.81)	24VDC 120VAC	P2LCX593EENDDG49 P2LCX593EENDDG53
	1/2"	2.7	P2LDX	17 / 17	1.78 (0.81)	24VDC 120VAC	P2LDX594EENDDG49 P2LDX594EENDDG53

Notes: Above valves are rated for an operating temperature from 14°F to 122°F (-10°C to 50°C). See model code matrix for additional options.
 Response time: Actuate to 90% pressure / return to exhaust to 10% of supply pressure. 93 PSIG (6.3 bar) / temperature 68°F (20°C).

Double Solenoid, 4-way, 3-position All Ports Blocked, 3-position Center Exhaust, Normal Operating Pressure / Temperature



Solenoid	Port size (NPT)	Cv	Valve type	Response time (msec)	Weight lb (kg)	Voltage	Part number	
							All ports blocked	Center exhaust
  22mm DIN P2LBX 22mm DIN Shown	1/8"	0.5	P2LAX	18 / 40	0.62 (0.28)	24VDC 120VAC	P2LAX691EENDDDB49 P2LAX691EENDDDB53	P2LAX891EENDDDB49 P2LAX891EENDDDB53
	1/4"	0.9	P2LBX	22 / 55	0.97 (0.44)	24VDC 120VAC	P2LBX692EENDDDB49 P2LBX692EENDDDB53	P2LBX892EENDDDB49 P2LBX892EENDDDB53
	3/8"	1.8	P2LCX	30 / 90	2.45 (1.11)	24VDC 120VAC	P2LCX693EENDDDB49 P2LCX693EENDDDB53	P2LCX893EENDDDB49 P2LCX893EENDDDB53
	1/2"	1.9	P2LDX	30 / 90	2.45 (1.11)	24VDC 120VAC	P2LDX694EENDDDB49 P2LDX694EENDDDB53	P2LDX894EENDDDB49 P2LDX894EENDDDB53
 18" Grommet P2LBX 18" Grommet Shown	1/8"	0.5	P2LAX	18 / 40	0.62 (0.28)	24VDC 120VAC	P2LAX691EENDDG49 P2LAX691EENDDG53	P2LAX891EENDDG49 P2LAX891EENDDG53
	1/4"	0.9	P2LBX	22 / 55	0.97 (0.44)	24VDC 120VAC	P2LBX692EENDDG49 P2LBX692EENDDG53	P2LBX892EENDDG49 P2LBX892EENDDG53
	3/8"	1.8	P2LCX	30 / 90	2.45 (1.11)	24VDC 120VAC	P2LCX693EENDDG49 P2LCX693EENDDG53	P2LCX893EENDDG49 P2LCX893EENDDG53
	1/2"	1.9	P2LDX	30 / 90	2.45 (1.11)	24VDC 120VAC	P2LDX694EENDDG49 P2LDX694EENDDG53	P2LDX894EENDDG49 P2LDX894EENDDG53

Notes: Above valves are rated for an operating temperature from 14°F to 122°F (-10°C to 50°C). See model code matrix for additional options.
 Response time: Actuate to 90% pressure / return to exhaust to 10% of supply pressure. 93 PSIG (6.3 bar) / temperature 68°F (20°C).

 Most popular.



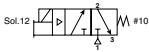

Single Solenoid, 3-way, 2-position, Xtreme Operating Pressure / Temperature

Solenoid	Port size (NPT)	Cv	Valve type	Response time (msec)	Weight lb (kg)	Voltage	Part number
  P2LBX 22mm DIN Shown	1/8"	0.7	P2LAX	15 / 45	0.84 (0.38)	12VDC	P2LAX391ESHDDDB47
						24VDC	P2LAX391ESHDDDB48
	1/4"	1.3	P2LBX	25 / 65	0.84 (0.38)	12VDC	P2LBX392ESHDDDB47
						24VDC	P2LBX392ESHDDDB48
	3/8"	2.5	P2LCX	25 / 85	1.01 (0.46)	12VDC	P2LCX393ESHDDDB47
						24VDC	P2LCX393ESHDDDB48
1/2"	2.7	P2LDX	25 / 85	1.01 (0.46)	12VDC	P2LDX394ESHDDDB47	
					24VDC	P2LDX394ESHDDDB48	
 P2LBX 18" Grommet Shown	1/8"	0.7	P2LAX	15 / 45	0.84 (0.38)	12VDC	P2LAX391ESHDDG47
						24VDC	P2LAX391ESHDDG48
	1/4"	1.3	P2LBX	25 / 65	0.84 (0.38)	12VDC	P2LBX392ESHDDG47
						24VDC	P2LBX392ESHDDG48
	3/8"	2.5	P2LCX	25 / 85	1.01 (0.46)	12VDC	P2LCX393ESHDDG47
						24VDC	P2LCX393ESHDDG48
1/2"	2.7	P2LDX	25 / 85	1.01 (0.46)	12VDC	P2LDX394ESHDDG47	
					24VDC	P2LDX394ESHDDG48	

Notes: Above valves have Mobile Rate Coils and are rated for an operating temperature from -40°F to 140°F (-40°C to 60°C). See model code matrix for additional options.

Response time: Actuate to 90% pressure / return to exhaust to 10% of supply pressure. 93 PSIG (6.3 bar) / temperature 68°F (20°C).

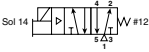
Single Solenoid, 4-way, 2-position, Xtreme Operating Pressure / Temperature

Solenoid	Port size (NPT)	Cv	Valve type	Response time (msec)	Weight lb (kg)	Voltage	Part number
  P2LBX 22mm DIN Shown	1/8"	0.7	P2LAX	15 / 45	0.84 (0.38)	12VDC	P2LAX591ESHDDDB47
						24VDC	P2LAX591ESHDDDB48
	1/4"	1.3	P2LBX	20 / 55	0.84 (0.38)	12VDC	P2LBX592ESHDDDB47
						24VDC	P2LBX592ESHDDDB48
	3/8"	2.5	P2LCX	25 / 85	1.01 (0.46)	12VDC	P2LCX593ESHDDDB47
						24VDC	P2LCX593ESHDDDB48
1/2"	2.7	P2LDX	25 / 85	1.01 (0.46)	12VDC	P2LDX594ESHDDDB47	
					24VDC	P2LDX594ESHDDDB48	
 P2LAX 18" Grommet Shown	1/8"	0.7	P2LAX	15 / 45	0.84 (0.38)	12VDC	P2LAX591ESHDDG47
						24VDC	P2LAX591ESHDDG48
	1/4"	1.3	P2LBX	25 / 65	0.84 (0.38)	12VDC	P2LBX592ESHDDG47
						24VDC	P2LBX592ESHDDG48
	3/8"	2.5	P2LCX	28 / 85	1.01 (0.46)	12VDC	P2LCX593ESHDDG47
						24VDC	P2LCX593ESHDDG48
1/2"	2.7	P2LDX	25 / 85	1.01 (0.46)	12VDC	P2LDX594ESHDDG47	
					24VDC	P2LDX594ESHDDG48	



Notes: Above valves have Mobile Rate Coils and are rated for an operating temperature from -40°F to 140°F (-40°C to 60°C). See model code matrix for additional options.

Response time: Actuate to 90% pressure / return to exhaust to 10% of supply pressure. 93 PSIG (6.3 bar) / temperature 68°F (20°C).

 Most popular.



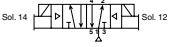

Double Solenoid, 4-way, 2-position, Xtreme Operating Pressure / Temperature

Solenoid	Port size (NPT)	Cv	Valve type	Response time (msec)	Weight lb (kg)	Voltage	Part number
  22mm DIN P2LBX 22mm DIN Shown	1/8"	0.7	P2LAX	11 / 11	0.60 (0.27)	12VDC 24VDC	P2LAX591EEHDDDB47 P2LAX591EEHDDDB48
	1/4"	1.3	P2LBX	13 / 13	0.93 (0.42)	12VDC 24VDC	P2LBX592EEHDDDB47 P2LBX592EEHDDDB48
	3/8"	2.5	P2LCX	18 / 18	1.06 (0.48)	12VDC 24VDC	P2LCX593EEHDDDB47 P2LCX593EEHDDDB48
	1/2"	2.7	P2LDX	18 / 18	1.06 (0.48)	12VDC 24VDC	P2LDX594EEHDDDB47 P2LDX594EEHDDDB48
 18" Grommet P2LAX 18" Grommet Shown	1/8"	0.7	P2LAX	11 / 11	0.60 (0.27)	12VDC 24VDC	P2LAX591EEHDDG47 P2LAX591EEHDDG48
	1/4"	1.3	P2LBX	13 / 13	0.93 (0.42)	12VDC 24VDC	P2LBX592EEHDDG47 P2LBX592EEHDDG48
	3/8"	2.5	P2LCX	18 / 18	1.06 (0.48)	12VDC 24VDC	P2LCX593EEHDDG47 P2LCX593EEHDDG48
	1/2"	2.7	P2LDX	18 / 18	1.06 (0.48)	12VDC 24VDC	P2LDX594EEHDDG47 P2LDX594EEHDDG48

Notes: Above valves have Mobile Rate Coils and are rated for an operating temperature from -40°F to 140°F (-40°C to 60°C). See model code matrix for additional options.
 Response time: Actuate to 90% pressure / return to exhaust to 10% of supply pressure. 93 PSIG (6.3 bar) / temperature 68°F (20°C).

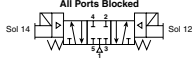
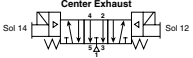
Double Solenoid, 4-way, 3-position All Ports Blocked, 3-position Center Exhaust, Xtreme Operating Pressure / Temperature

Solenoid	Port size	Cv	Valve type (NPT)	Response time (msec)	Weight lb (kg)	Voltage	Part number	
							All ports blocked	Center exhaust
  22mm DIN P2LBX 22mm DIN Shown	1/8"	0.5	P2LAX	18 / 40	0.62 (0.28)	12VDC 24VDC	P2LAX691EEHDDDB47 P2LAX691EEHDDDB48	P2LAX891EEHDDDB47 P2LAX891EEHDDDB48
	1/4"	0.9	P2LBX	22 / 55	0.97 (0.44)	12VDC 24VDC	P2LBX692EEHDDDB47 P2LBX692EEHDDDB48	P2LBX892EEHDDDB47 P2LBX892EEHDDDB48
	3/8"	1.8	P2LCX	30 / 90	2.45 (1.11)	12VDC 24VDC	P2LCX693EEHDDDB47 P2LCX693EEHDDDB48	P2LCX893EEHDDDB47 P2LCX893EEHDDDB48
	1/2"	1.9	P2LDX	30 / 90	2.45 (1.11)	12VDC 24VDC	P2LDX694EEHDDDB47 P2LDX694EEHDDDB48	P2LDX894EEHDDDB47 P2LDX894EEHDDDB48
 18" Grommet P2LBX 18" Grommet Shown	1/8"	0.5	P2LAX	18 / 40	0.62 (0.28)	12VDC 24VDC	P2LAX691EEHDDG47 P2LAX691EEHDDG48	P2LAX891EEHDDG47 P2LAX891EEHDDG48
	1/4"	0.9	P2LBX	22 / 55	0.97 (0.44)	12VDC 24VDC	P2LBX692EEHDDG47 P2LBX692EEHDDG48	P2LBX892EEHDDG47 P2LBX892EEHDDG48
	3/8"	1.8	P2LCX	30 / 90	2.45 (1.11)	12VDC 24VDC	P2LCX693EEHDDG47 P2LCX693EEHDDG48	P2LCX893EEHDDG47 P2LCX893EEHDDG48
	1/2"	1.9	P2LDX	30 / 90	2.45 (1.11)	12VDC 24VDC	P2LDX694EEHDDG47 P2LDX694EEHDDG48	P2LDX894EEHDDG47 P2LDX894EEHDDG48

Notes: Above valves have Mobile Rate Coils and are rated for an operating temperature from -40°F to 140°F (-40°C to 60°C). See model code matrix for additional options.
 Response time: Actuate to 90% pressure / return to exhaust to 10% of supply pressure. 93 PSIG (6.3 bar) / temperature 68°F (20°C).

 Most popular.

Single & Double Solenoid Operated Valves

P2L A X 5 91 E S H D D G 49

Valve size	
1/8"	A
1/4"	B
3/8"	C
1/2"	D

Series	
Viking Xtreme	X

Voltage / frequency	
42	24VAC
45	12VDC
47*	12 VDC mobile
48*	24 VDC mobile
49	24VDC
53	120VAC
57	240VAC
Blank	Valve less coil

* Only available with enclosures "A", "B" & "G". Additional voltages are available upon request. Contact customer support for more information.

Valve type / function	
<i>Internal pilot supply to solenoid*</i>	
3/2 NC - 2-position	3
5/2 2-position	5
5/3 3-position, APB	6
5/3 3-position, PC	7
5/3 3-position, CE	8
<i>External pilot supply to the solenoids through ports #12 & #14</i>	
3/2 NC - 2-position	L
5/2 2-position	N
5/3 3-position, APB	P
5/3 3-position, PC	Q
5/3 3-position, CE	R

* Size A & B solenoid valves can be field converted from internal to external pilot. See page 22 for details.

Enclosures / lead length	
A	30mm square 3-pin – ISO 4400 Form A (male only)
B	22mm rectangular 3-pin – type B industrial (male only)
E*	Intrinsically safe, FM / CSA
F†	Hazardous duty, FM / CSA
G	Grommet - 18" leads
H	1/2" NPT conduit - 18" leads
N	Solenoid pilot operator less coil

* Only available with voltage code "49" & override option "A", valve type "N" Only.

† Valve Type "N" Only.

Main port thread	
G1/8 (P2LA)	11
G1/4 (P2LB)	12
G1/4 (P2LB) NAMUR Mount	1N*
G3/8 (P2LC)	13
G1/2 (P2LD)	14
1/8" NPT (P2LA)	91
1/4" NPT (P2LB)	92
1/4" NPT (P2LB) NAMUR Mount	9N*
3/8" NPT (P2LC)	93
1/2" NPT (P2LD)	94

* NAMUR mount available for 5/2, 2-position only.

Overrides	
A	No override
C*	Flush - locking
D	Extended non-locking

* Override for valve type N only.

Solenoid pilot type	
D	Pilot exhaust vented
N	Tapped pilot exhaust (M5)

12 End operator	
Double solenoid operated valve	E
Single solenoid spring return	S*

* Not available with 3-position valves.

Valve type	
N	Normal vacuum to 145 PSIG (10 bar) 14°F to 122°F (-10°C to 50°C)
H*	Xtreme vacuum to 232 PSIG (16 bar) -40°F to 140°F (-40°C to 60°C)

* P2LC and P2LD solenoid operated valves have a maximum pressure rating of 175 PSIG (12 bar)

 Most popular.



Parker Pneumatic

Single Remote Pilot, 3-way, 2-position, Xtreme Operating Pressure / Temperature

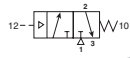

P2LAX Shown

Port size (NPT)	Cv	Response time (msec)	Weight lb (kg)	Valve type	Part number
1/8"	0.7	15 / 45	0.68 (0.31)	P2LAX	P2LAX391PS
1/4"	1.3	25 / 65	0.68 (0.31)	P2LBX	P2LBX392PS
3/8"	2.5	25 / 65	0.88 (0.40)	P2LCX	P2LCX393PS
1/2"	2.7	25 / 65	0.88 (0.40)	P2LDX	P2LDX394PS

Single Remote Pilot, 4-way, 2-position, Xtreme Operating Pressure / Temperature

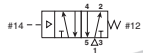

P2LAX Shown

Port size (NPT)	Cv	Response time (msec)	Weight lb (kg)	Valve type	Part number
1/8"	0.7	15 / 45	0.33 (0.15)	P2LAX	P2LAX591PS
1/4"	1.3	20 / 55	0.68 (0.31)	P2LBX	P2LBX592PS
3/8"	2.5	25 / 85	0.90 (0.41)	P2LCX	P2LCX593PS
1/2"	2.7	25 / 85	0.90 (0.41)	P2LDX	P2LDX594PS

Double Remote Pilot, 4-way, 2-position, Xtreme Operating Pressure / Temperature

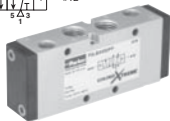

P2LBX Shown

Port size (NPT)	Cv	Response time (msec)	Weight lb (kg)	Valve type	Part number
1/8"	0.7	11 / 11	0.33 (0.15)	P2LAX	P2LAX591PP
1/4"	1.3	13 / 13	0.68 (0.31)	P2LBX	P2LBX592PP
3/8"	2.5	18 / 18	0.90 (0.41)	P2LCX	P2LCX593PP
1/2"	2.7	18 / 18	0.90 (0.41)	P2LDX	P2LDX594PP

Double Remote Pilot, 4-way, 3-position All Ports Blocked, 3-position Center Exhaust, Xtreme Operating Pressure / Temperature



P2LAX Shown

Port size (NPT)	Cv	Response time (msec)	Weight lb (kg)	Valve type	Part number	
					All ports blocked	Center exhaust
1/8"	0.5	18 / 50	0.31 (0.14)	P2LAX	P2LAX691PP	P2LAX891PP
1/4"	0.9	25 / 65	0.73 (0.33)	P2LBX	P2LBX692PP	P2LBX892PP
3/8"	1.8	30 / 90	0.93 (0.42)	P2LCX	P2LCX693PP	P2LCX893PP
1/2"	1.9	30 / 90	0.93 (0.42)	P2LDX	P2LDX694PP	P2LDX894PP

Notes: Above valves are rated for an operating temperature from -40°F to 140°F (-40°C to 60°C). See model code matrix for additional options.
Response time: Actuate to 90% pressure / return to exhaust to 10% of supply pressure. 93 PSIG (6.3 bar) / temperature 68°F (20°C).

Remote Air Pilot Operated Valves

P2L A X 5 91 PS

Valve size	
1/8"	A
1/4"	B
3/8"	C*
1/2"	D*

* P2LCX and P2LDX manual & remote air pilot valves have a maximum pressure rating of 175 PSIG (12 bar).

Operators / return	
PP	Double remote pilot
PS*	Single remote pilot, spring return

* Not available with 3-position valves.

Main port thread	
11	G1/8 (P2LA)
12	G1/4 (P2LB)
13	G3/8 (P2LC)
14	G1/2 (P2LD)
91	1/8" NPT (P2LA)
92	1/4" NPT (P2LB)
93	3/8" NPT (P2LC)
94	1/2" NPT (P2LD)

Note: NAMUR Mount for P2LBX is available upon request.

Valve type / function	
<i>Internal pilot supply to solenoid</i>	
3/2 NC - 2-position	3
5/2 2-position	5
5/3 3-position, APB	6
5/3 3-position, PC	7
5/3 3-position, CE	8

Most popular.



ATEX Certified Single & Double Solenoid Operated Valves

Vacuum to 145 PSIG (vacuum to 10 bar)

14°F to 122°F 22mm coils (enclosure option M)

-4°F to 122°F 30mm coils (enclosure option S)

P2L A X 5 91 E S A D D M 49

Valve size	
1/8"	A
1/4"	B
3/8"	C
1/2"	D

Valve type / function	
<i>Internal Pilot Supply to Solenoid</i>	
2-position valve	5
3-position valve APB	6
3-position valve PC	7
3-position valve CE	8
<i>External Pilot Supply to Solenoids through Ports #12 & #14</i>	
2-position valve	N
3-position valve APB	P
3-position valve PC	Q
3-position valve CE	R

Main port thread	
G1/8 (P2LA)	11
G1/4 (P2LB)	12
G3/8 (P2LC)	13
G1/2 (P2LD)	14
1/8" NPT (P2LA)	91
1/4" NPT (P2LB)	92
3/8" NPT (P2LC)	93
1/2" NPT (P2LD)	94

Voltage	
49	24VDC

Enclosures	
M	ATEX 8-22T EExm T4 135°C

Overrides	
D	Extended non-locking

Solenoid pilot type	
D	Vented pilot exhaust
N	Tapped pilot exhaust (M5)

12 end operator	
E	Double solenoid operated valve
S	Single solenoid spring return

NOTE: For ATEX certified remote air pilot valves, build the valve part number from the model number index for remote pilot and add "-EX" following the number.

Example: P2LAX591PS-EX

Note: all valves include a 3 meter sealed cable with assembly.



ATEX Certified Solenoid Pilot Assemblies

P2F S 1 3 A 3 D M 49

Voltage	
49	24VDC

Enclosures	
M	ATEX 8-22T EExm T4 135°C

Note: all valves include a 3 meter sealed cable with assembly.

IEM Bar Manifold, Viking Xtreme Solenoid / Remote Pilot Valves



Valve series	Valve function	## -Stations	Manifold only (NPT)	Manifold only (BSPP)
P2LAX*	3-way	02 - 12	P2LAXGAXN##NP	P2LAXGAXG##NP
P2LAX*	4-way	02 - 12	P2LAXMAXN##NP	P2LAXMAXG##NP
P2LBX*	3-way	02 - 12	P2LBXGAXN##NP	P2LBXGAXG##NP
P2LBX*	4-way	02 - 12	P2LBXMAXN##NP	P2LBXMAXG##NP
P2LCX	3-way / 4-way	02 - 12	P2LCXMAXN##NP	P2LCXMAXG##NP

Kits include: (1) manifold, valve hold down bolts and o-rings. Replace ## with number of valve stations.
 * 30mm solenoid coil option "A" not available on IEM bar manifold P2LAX or P2LBX.

IEM Bar Manifold Add-A-Fold Assembly (Viking Xtreme Solenoid / Remote Pilot Valves Only)



Valve series	Valve function	## -Stations	Manifold only (NPT)	Manifold only (BSPP)
P2LAX*	3-way	02 - 12	AAPL2AXGAXG##NP	AAPL2AXGAXG##NP
P2LAX*	4-way	02 - 12	AAPL2AXMAXN##NP	AAPL2AXMAXG##NP
P2LBX*	3-way	02 - 12	AAPL2BXGAXG##NP	AAPL2BXGAXG##NP
P2LBX*	4-way	02 - 12	AAPL2BXMAXN##NP	AAPL2BXMAXG##NP
P2LCX	3-way / 4-way	02 - 12	AAPL2CXMAXN##NP	AAPL2CXMAXG##NP

Kits include: (1) manifold, valve hold down bolts, o-rings and assembly. Replace ## with number of valve stations.
 * 30mm solenoid coil option "A" not available on IEM bar manifold P2LAX or P2LBX.

- How to Order: 1. List Add-A-Fold assembly part number as line item 1
 2. List the desired valves series part number in subsequent line items after the Add-A-Fold Assembly part number to complete the ordering code. Include all valves and blanking kits required. The left most station is station # 1 looking at the #12 end of the manifold.

Example: B3, 4-way manifold with station #1 blanked off with valves assembled

Line	Qty	Part number	Comment
1	1	AAPL2BXMAXN02NP	Add-A-Fold Assembly, 2-station IEM bar manifold
2	2	P2LBX591ESNNDDDB49	4-way, Station 1, 2

Blanking Plate

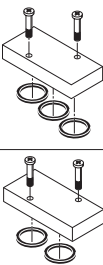

Type	Kit number
P2LAX 4-way	9121658063
P2LBX 4-way	9121594809X
P2LCX 3 & 4 way	P2LCXK20P
P2LAX 3-way	912132BPSXZ
P2LBX 3-way	912132BPSXZ

Kit includes: plate, screws, o-rings

Manifold Bolts

Type	Qty.	Kit number
P2LAX	12	P2LAXK87P
P2LBX	12	P2LBXK87P
P2LCX	12	P2LCXK87P

Manifold O-rings

Type	Qty.	Kit number
P2LAX	30	P2LAXK84P
P2LBX	18	P2LBXK84P
P2LCX	12	P2LCXK84P

Most popular.



22mm Solenoid Pilot Operators & Coils

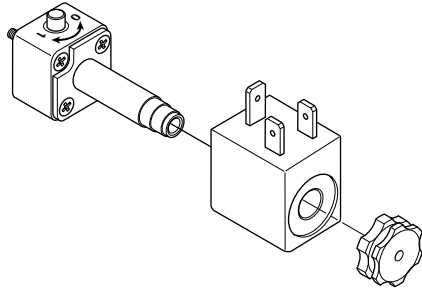

22mm solenoid pilot options

The P2FP13*4* (NC) 3/2 solenoid pilot operators are designed for piloting pneumatic control valves with compressed air or other inert gases.

The P2FP operator is available for Normal operating pressures up to 10 bar or the Xtreme maximum operating pressure of 16 bar and wide band voltage tolerances required for mobile applications.

Corrosion resistant design

The pilot valve body is manufactured in thermoplastic PA6 material and the core tube brass / stainless steel. The plunger / core is made from stainless steel and the valve seats from FKM.

Solenoid pilot exhaust

These operators all exhaust out of the top of the core tube which is tapped M5. The standard solenoid nut (Solenoid pilot type "D") fitted to the core tube is a diffuser nut which allows the exhaust to escape to atmosphere. This nut also minimizes ingress of dirt into the valve through this port. The alternative plastic knurled nut (Solenoid pilot type "N") can be specified (refer to part number system) if the exhaust air needs captured and piped away using the M5 tapped port.

Mobile applications

Viking Xtreme valves are tested to +5g shock and vibration. Solenoid operated valves are designed to operate with wide voltage tolerance bands within the ambient temperature ranges stated in the technical section.

Coils

Coils are wound with enameled copper wire, having a temperature index of 180°C with class F insulation (155°C) and are encapsulated in Thermoplastic resin. When fitted with suitable connector and correct gasket, they give protection to IP65.

Manual override options

The pilot operators can be supplied with locking or non-locking manual override. The standard manual override is the monostable (spring return) extended brass override. Alternatively the bistable (locking) override can be specified as an alternative for the Normal duty 10 bar option.

Spares

Solenoid operators are available as spares complete with mounting screws and seals. Coils and connectors should be ordered separately unless ATEX certified and intrinsically safe is needed. ATEX certified operators and coils must be ordered together.

Transients

Interrupting the current through the solenoid coil produces momentary voltage peaks which, under unfavorable conditions, can amount to several hundred times the rated operating voltage. Normally, these transients do not cause problems, but to achieve the maximum life of relays in the circuit (and particularly of transistors, thyristors and integrated circuits) it is desirable to provide protection by means of voltage-dependent resistors (varistors). All connectors / cable plugs with LEDs include this type of circuit protection.

Materials

Pilot Valve

Body	Polyamide
Armature tube:	
Normal pilot operator.....	Brass
Xtreme pilot operator.....	Stainless steel
Plunger & core.....	Corrosion resistant CR-NI steel
Seals.....	FKM (viton™)
Screws.....	Stainless steel

Coil

Encapsulation material	Thermoplastic
------------------------------	---------------

ATEX



ATEX is a European Directive (94/9/EC) valid for products to be used within an explosive atmosphere.

Both ATEX certified solenoid, remote pilot and manual operated valves, as well as complete solenoid pilot assemblies are available. For specific information regarding ATEX certification please visit www.parker/pneumatics.

Pilot Operator Kits

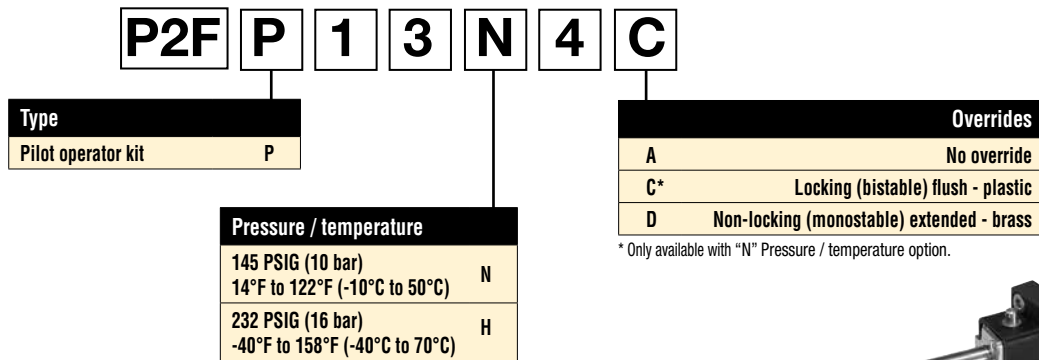

Solenoid Kits

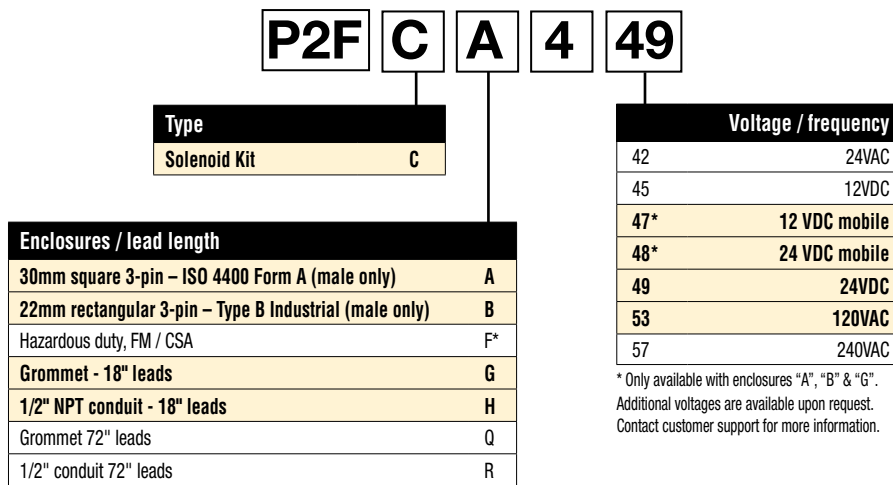

Solenoid Enclosures



Option A
30mm Square,
3-Pin ISO 4400, DIN 43650A



Option B
22mm Rectangular,
3-Pin DIN, Type B Industrial



Option G & Q
Grommet, 18" or 72" Leads





Option H & R
1/2" Conduit, 18" or 72" Leads

Solenoid Information (Solenoids are rated for continuous duty.)

Voltage Code	Enclosure "A"			Enclosure "B" to "R"			
	AC 60Hz	DC 50Hz	DC	Power consumption	Holding (amps)	Power consumption	Holding (amps)
42	24	22		3.9VA	.14	7.3VA	.31
45	—	—	12	2.6W	.21	4.6W	.37
47*	—	—	12	6.2W	.52	5.5W	.46
48*	—	—	24	6.8W	.29	6.0W	.25
49	—	—	24	2.7W	.11	4.8W	.20
53	120	110	—	4.1VA	.04	6.3VA	.05
57	240	230	—	3.7VA	.02	6.4VA	.03

* Mobile voltages. Solenoid voltage characteristics for all coils located on page 23.

Replacement Solenoid Nut

Description	Part number	Description	Part number
 Solenoid diffuser nut	PS1556	 Solenoid vented nut	PS2892P

 Most popular.



Parker Pneumatic

Intrinsically safe solenoid valves (“E” option)

Hazardous location class:

Class I; Groups A, B, C & D

Class II; Groups E, F, & G

Class III; Div. I

For use in low voltage (24VDC) Intrinsically Safe applications. NO OTHER VOLTAGE IS APPROVED.

Comes standard with non-lighted solenoid connector.

36mm Coil width.

Must be connected to an FM approved Barrier.

For dimensions, reference standard solenoid models.

Maximum internally piloted valve pressure is 115 PSIG.

Pressures to 145 PSIG can be used when external pilot is utilized and pilot pressure is limited to 115 PSIG.

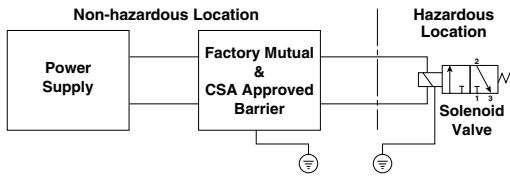

Intrinsically safe solenoid pilot assembly kits

Description	Part number
24VDC	P2FS13N1AE49

Kit includes: coil, connector, o-ring & screws

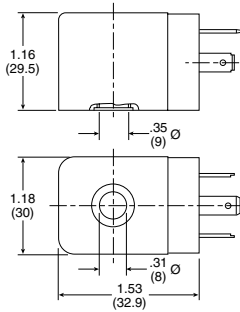

**Viking Xtreme Series Valves
Intrinsically Safe Valves, Pilot Conversion**

Hazardous duty solenoid valves (“F” option)

Hazardous location class:

Class I; Zone I EX, M, II & T4

Class I; Div. I, Groups A, B, C, & D

Class II & III; Div. I, Groups E, F, & G

Comes standard with 1/2" conduit connection.

Voltage range = ±10%

Ambient temperature range = -20°C (-4°F) to 60°C (140°F)

Duty factor = 100%

IP65 Rated (with connected conduit connector)

Notes:

1. Maximum non-hazardous location voltage not to exceed 250V RMS.
2. Connect per Barrier Manufacturers instructions.
3. Factory Mutual requires connections per ISA RP 12.6 instructions.
4. CSA requires “Installation to be in accordance with the Canadian Electrical Code, Part I.”
5. The hazardous duty coils are wider in size than size A, B, C & D valves.
If mounted on a manifold, the valves need to be staggered to fit.



**Option F
Hazardous Duty FM / CSA**

Internal to external pilot conversion (size A & B only)

To convert from Internal to External Pilot Valve, simply remove the (2) fasteners that attach the end cap to the valve body. Rotate the end cap 180° and attach back to the valve body. For single solenoid valves, only the 14-End needs to be rotated. For double solenoid valves, both ends must be converted for proper function.

The 12 & 14-Ports are always tapped no matter what Valve Type / Function is selected. For Internal Pilot Function, ports do NOT need to be plugged.

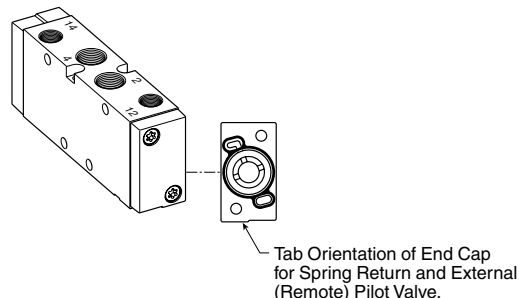
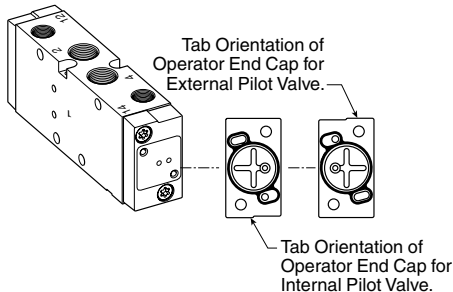

Operating temperature

- **Normal**.....14°F to 122°F (-10°C to 50°C)
- **Xtreme**..... -40°F to 158°F (-40°C to 70°C)

Flow Rating

Valve size	Port size	2-position	3-position
P2LAX	1/8"	0.7	0.5
P2LBX	1/4"	1.3	0.9
P2LCX	3/8"	2.5	1.8
P2LDX	1/2"	2.7	1.9

Operating pressure*

**Maximum: Normal Valve Type.....145 PSIG (10 bar)
Xtreme Valve Type.....232 PSIG (16 bar)**

Minimum:

Valve type - internal pilot	Minimum PSIG (bar)			
	P2LAX	P2LBX	P2LCX	P2LDX
Single solenoid - spring return	46 (3.2)	51 (3.5)	51 (3.5)	51 (3.5)
Single remote pilot - spring return	46 (3.2)	51 (3.5)	51 (3.5)	51 (3.5)
Double solenoid - 2-position	22 (1.5)	22 (1.5)	22 (1.5)	22 (1.5)
Double remote pilot - 2-position	22 (1.5)	22 (1.5)	22 (1.5)	22 (1.5)
Double solenoid - 3-position (APB, PC, CE)	51 (3.5)	51 (3.5)	51 (3.5)	51 (3.5)
Double remote pilot - 3-position (APB, PC, CE)	51 (3.5)	51 (3.5)	51 (3.5)	51 (3.5)

Valve type - External pilot	P2LAX	P2LBX	P2LCX	P2LDX
All Viking series	Vacuum			

* P2LC and P2LD solenoid operated valves have a maximum pressure rating of 175 PSIG (12 bar)

Solenoid voltage characteristics

Non-mobile coils

+10% / -10% for all coils with Normal and Xtreme Operators

Mobile coils - normal pilot operator

22mm 12 & 24VDC - Mobile (47 & 48 voltage code)

Operating temperature			
Minimum inlet pressure (bar)	Operating temperature		
	-10°C	+10°C	+50°C
3	+30 / -25% VDC	+30 / -20% VDC	+25 / -15% VDC
6	+30 / -30% VDC	+30 / -25% VDC	+25 / -20% VDC
8	+30 / -30% VDC	+30 / -30% VDC	+25 / -25% VDC
10	+30 / -30% VDC	+30 / -30% VDC	+25 / -30% VDC

30mm 12 & 24VDC - Mobile (47 & 48 voltage code)

Operating temperature			
Minimum inlet pressure (bar)	Operating temperature		
	-10°C	+10°C	+50°C
3	+30 / -30% VDC	+30 / -30% VDC	+25 / -30% VDC
6	+30 / -30% VDC	+30 / -30% VDC	+25 / -30% VDC
8	+30 / -30% VDC	+30 / -30% VDC	+25 / -30% VDC
10	+30 / -30% VDC	+30 / -30% VDC	+25 / -30% VDC

Mobile coils - Xtreme pilot operator

22mm 12 & 24VDC - Mobile (47 & 48 voltage code)

Operating temperature				
Minimum inlet pressure (bar)	Operating temperature			
	-40°C	+10°C	+50°C	+70°C
4	+30 / -25% VDC	+30 / -25% VDC	+30 / -10% VDC	+20 / -10% VDC
8	+30 / -30% VDC	+30 / -25% VDC	+30 / -15% VDC	+20 / -15% VDC
12	+30 / -30% VDC	+30 / -30% VDC	+30 / -15% VDC	+20 / -15% VDC
16	+30 / -30% VDC	+30 / -30% VDC	+30 / -20% VDC	+20 / -20% VDC

30mm 12 & 24VDC - Mobile (47 & 48 voltage code)

Operating temperature				
Minimum inlet pressure (bar)	Operating temperature			
	-40°C	+10°C	+50°C	+70°C
4	+30 / -30% VDC	+30 / -30% VDC	+25 / -30% VDC	+15 / -30% VDC
8	+30 / -30% VDC	+30 / -30% VDC	+25 / -30% VDC	+15 / -30% VDC
12	+30 / -30% VDC	+30 / -30% VDC	+25 / -30% VDC	+15 / -30% VDC
16	+30 / -30% VDC	+30 / -30% VDC	+25 / -30% VDC	+15 / -30% VDC

Note: All table ratings are based on 100% continuous duty and 5G shock vibration. At 50% continuous duty all ratings are +30% / -30% for all Temperatures and Pressures.

Female Electrical Connectors / Accessories

**30mm Square 3-Pin – ISO 4400, DIN 43650A
(Use with Enclosure “A”)**

Description	Connector with 6' (2m) cord	Connector
Unlighted	PS2028JCP	PS2028BP
Light – 6-48V, 50/60Hz, 6-48VDC	PS2032J79CP*	PS203279BP
Light – 120V/60Hz	PS2032J83CP*	PS203283BP
Light – 240V/60Hz	N/A	PS203283BP

* LED with surge suppression.

Note: Max ø6.5mm cable size required for connector w/o 6' (2m) cord. IP65 rated when properly installed.

Engineering data:

Conductors: 2 poles plus ground; cable range (connector only): 8 to 10mm (0.31 To 0.39 Inch); contact spacing: 18mm.

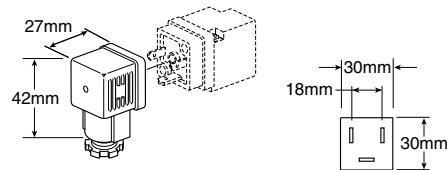

**22mm Rectangular 3-Pin – Type B Industrial
(Use with Enclosure “B”)**

Description	Connector with 6' (2m) cord	Connector
Unlighted	PS2429JBP	PS2429BP
Light – 24V60Hz, 24VDC	PS2430J79BP*	PS243079BP
Light – 120V/60Hz	PS2430J83BP*	PS243083BP
Light – 240V/60Hz	N/A	PS243087BP

* LED with surge suppression.

Note: Max ø6.5mm cable size required for connector w/o 6' (2m) cord. IP65 rated when properly installed.

Engineering data:

Conductors: 2 poles plus ground; cable range (connector only): 6 to 8mm (0.24 To 0.31 Inch); contact spacing: 11mm.

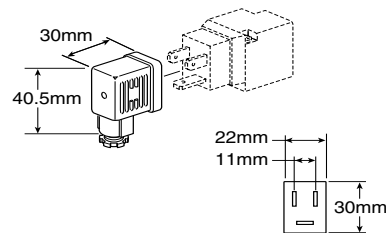

Exhaust Mufflers

Pipe thread	Part number
M5	P6M-PAC5
1/8" NPT	EM12
1/4" NPT	EM25
3/8" NPT	EM37
1/2" NPT	EM50

P6M - Plastic; EM - Sintered bronze



Plastic Silencers

Thread size	A (mm)	B (mm)	Part number	
			NPT	BSPT
M5	.43 (11)	.32 (8)	AS-5	
1/8"	1.57 (40)	.63 (16)	ASN-6	AS-6
1/4"	2.56 (65)	.83 (21)	ASN-8	AS-8
3/8"	3.35 (85)	.98 (25)	ASN-10	AS-10
1/2"	3.74 (95)	1.18 (30)	ASN-15	AS-15

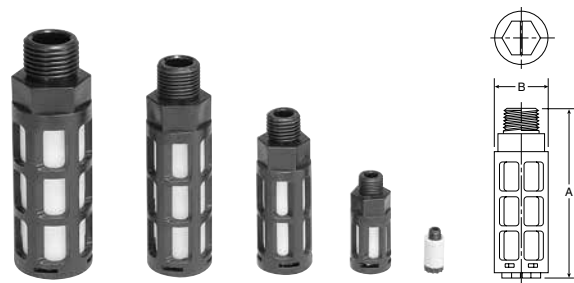

Exhaust Protector

Features

- 1/8 and 1/4 NPT male sizes
- Fitted with a brass pipe adapter and a fluorocarbon membrane
- Resistant to rust, clog, wash down and contamination

Applications

These protectors are intended for mobile applications, quick venting applications and alternative exhaust port breathers that require protection against clogging.

Ideal for valves exposed to harsh environmental conditions (which can cause a “caking up” in the exhaust pipe ports where the bronze mufflers or breather vents are installed).

Particularly suitable for time-sensitive applications such as axle-lift suspensions or pushers or tag axles.

Flow data (SCFM)

Size	60 PSIG Inlet	90 PSIG Inlet	125 PSIG Inlet	Part number
1/8"	40.1	56.5	75.5	E90016
1/4"	44.6	62.7	83.5	E90017

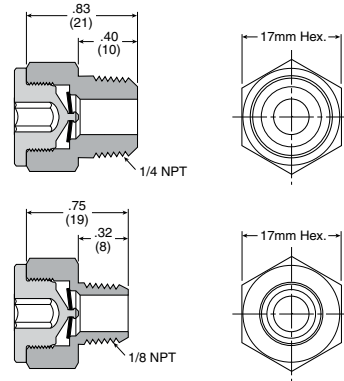

Operating information

Operating pressure:	0 to 150 PSIG (0 to 10 bar)
Operating temperature:	-40°F to 140°F (-40°C to 60°C)

Material specifications

Body & pipe adapter	Brass
Membrane	Fluorocarbon

Spool Service Kits

Description	Includes items (qty.)	Part number
Size A, 4-way, 2-position, solenoid & air pilot valves	1 (1), 3 (2), 4 (2)	P2LAXSK1
Size A, 4-way, 3-position, solenoid & air pilot valves	1 (1), 2 (2), 3 (2), 4 (2)	P2LAXSK2
Size A, 4-way, 2-position, manual valves	Spool only (not shown)	P2LAXSK3
Size A, 4-way, 3-position, manual valves	Spool only (not shown)	P2LAXSK4
Size B, 4-way, 2 & 3-position valves	1 (1), 3 (2), 4 (2)	P2LBXSK1
Size C & Size D, 4-way, 2 & 3-position valves	1 (1), 3 (2), 4 (2)	P2LCXDYSK1

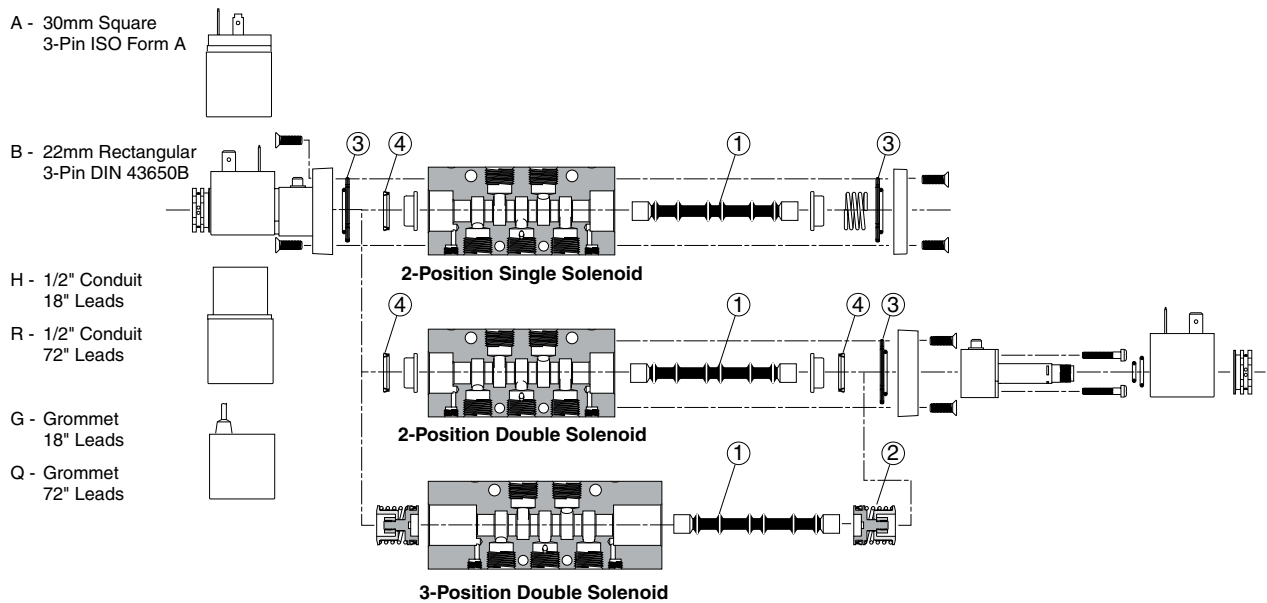

P2LAX 3/2 Single & Double Operators – Solenoid

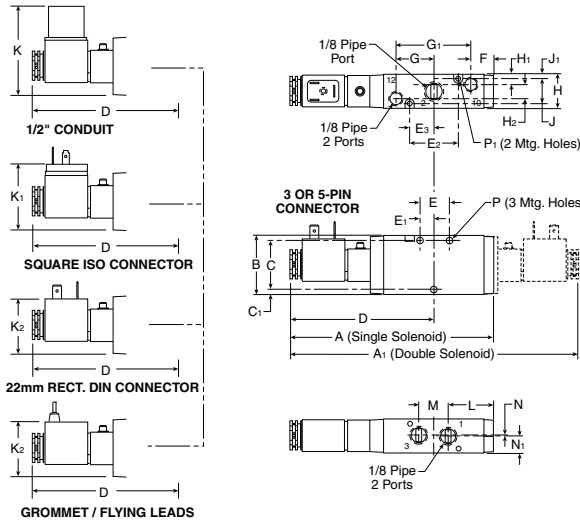

P2LAX 3/2 (solenoid)

A	A1	B	C	C1
5.35 (136)	7.60 (193)	1.57 (40)	1.26 (32)	.16 (4)
D	E	E1	E2	E3
3.80 (97)	.79 (20)	.39 (10)	1.26 (32)	.63 (16)
F	G	G1	H	H1
.55 (14)	.98 (25)	1.97 (50)	.87 (22)	.26 (6.6)
H2	J	J1	K	K1
.35 (9)	.65 (16.5)	.11 (2.9)	2.36 (60)	1.61 (41)
K2	L	M	N	N1
1.50 (38)	1.14 (29)	.79 (20)	.02 (0.5)	.42 (11)
P	P1			
Ø .17 Ø (4.3)	Ø .12 Ø (3.1)			

Inches (mm)

P2LAX 3/2 Single & Double Operators – Remote Pilot

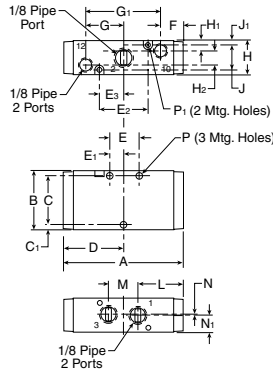

P2LAX 3/2 (remote)

A	B	C	C1	D
3.07 (78)	1.57 (40)	1.26 (32)	.16 (4)	1.54 (39)
E	E1	E2	E3	F
.79 (20)	.39 (10)	1.26 (32)	.63 (16)	.55 (14)
G	G1	H	H1	H2
.98 (25)	1.97 (50)	.87 (22)	.26 (6.6)	.35 (9)
J	J1	L	M	N
.65 (16.5)	.11 (2.9)	1.14 (29)	.79 (20)	.02 (0.5)
N1	P	P1		
.42 (11)	Ø .17 Ø (4.3)	Ø .12 Ø (3.1)		

Inches (mm)

P2LAX 5/2 & 5/3 Single & Double Operators, 4-way

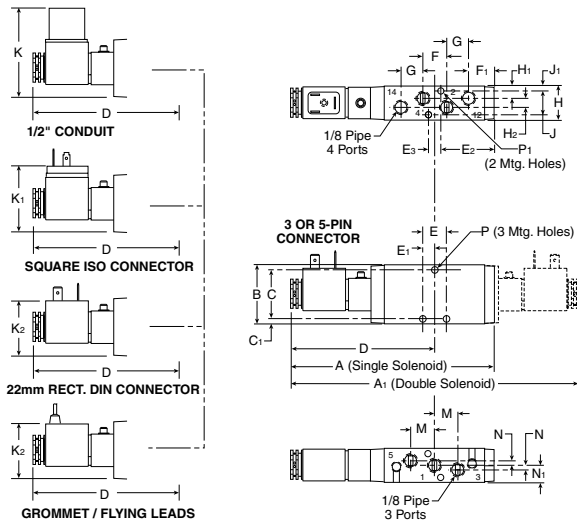

P2LAX 5/2 & 5/3 (solenoid)

A	A1	B	C	C1
5.47 (139)	7.72 (196)	1.57 (40)	1.30 (33)	.14 (3.5)
D	E	E1	E2	E3
3.86 (98)	.63 (16)	.31 (8)	1.42 (36)	.33 (8.5)
F	F1	G	H	H1
.63 (16)	.67 (17)	.59 (15)	.87 (22)	.31 (8)
H2	J	J1	K	K1
.24 (6)	.63 (16)	.12 (3)	2.36 (60)	1.61 (41)
K2	M	N	N1	P
1.50 (38)	.63 (16)	.12 (3)	.43 (11)	Ø .17 Ø (4.3)
P1				
Ø .12 Ø (3.1)				

Inches (mm)



P2LAX 5/2 & 5/3 Single & Double Operators – Remote Pilot

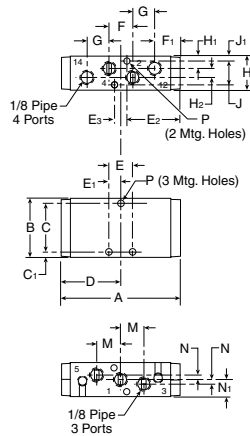

P2LAX 5/2 & 5/3 (remote)

A	B	C	C ₁	D
3.19 (81)	1.57 (40)	1.30 (33)	.14 (3.5)	1.59 (40.5)
E	E ₁	E ₂	E ₃	F
1.47 (16)	.31 (8)	1.42 (36)	.33 (8.5)	.63 (16)
F ₁	G	H	H ₁	H ₂
.67 (17)	.59 (15)	.87 (22)	.31 (8)	.24 (6)
J	J ₁	M	N	N ₁
.63 (16)	.12 (3)	.63 (16)	.12 (3)	.43 (11)
P	P ₁			
∅ .17 ∅ (4.3)	∅ .12 ∅ (3.1)			

Inches (mm)

P2LAX 3/2 Single & Double Operators – IEM Aluminum Bar Manifold

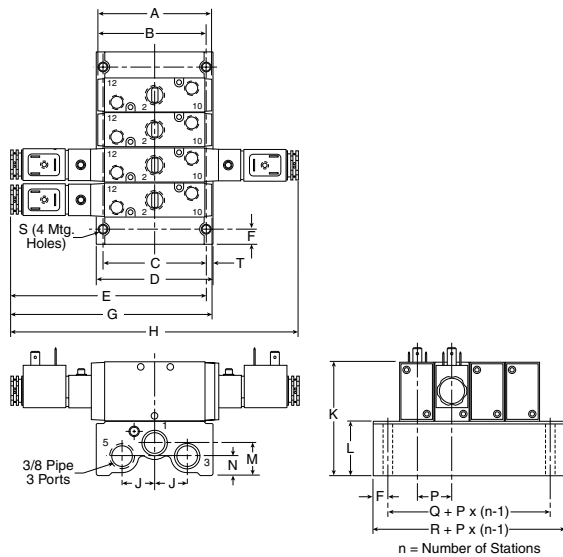

**P2LAX 3/2
IEM Aluminum bar manifold**

A	B	C	D	E
3.07 (78)	2.83 (72)	2.76 (70)	3.12 (79)	5.18 (132)
F	G	H	J	K
41 (10.5)	5.35 (136)	7.72 (193)	.87 (22)	3.11 (79)
L	M	N	P	Q
1.54 (39)	.87 (22)	.52 (13.2)	.93 (23.5)	1.56 (39.5)
R	S	T		
2.36 (60)	∅ .22 ∅ (5.5)	.18 (4.5)		

Inches (mm)

P2LAX 5/2 & 5/3 Single & Double Operators – IEM Aluminum Bar Manifold

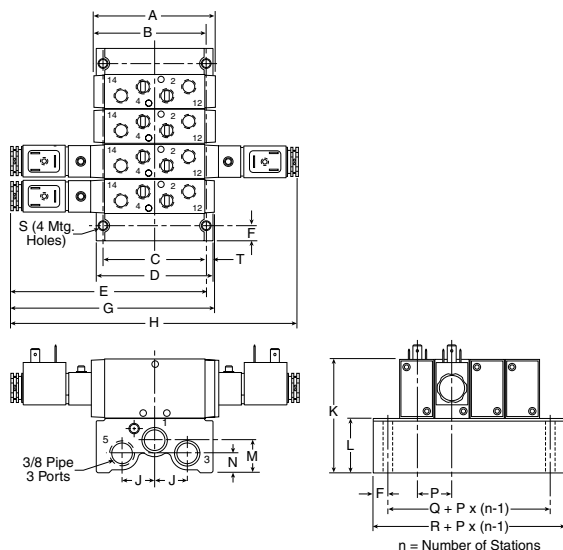

**P2LAX 5/2 & 5/3
IEM Aluminum bar manifold**

A	B	C	D	E
3.19 (81)	2.97 (76)	2.76 (70)	3.12 (79)	5.26 (134)
F	G	H	J	K
41 (10.5)	5.47 (139)	7.72 (196)	.87 (22)	3.11 (79)
L	M	N	P	Q
1.54 (39)	.87 (22)	.52 (13.2)	.93 (23.5)	1.56 (39.5)
R	S	T		
2.36 (60)	∅ .22 ∅ (5.5)	.18 (4.5)		

Inches (mm)



P2LBX 3/2 Single & Double Operators – Solenoid

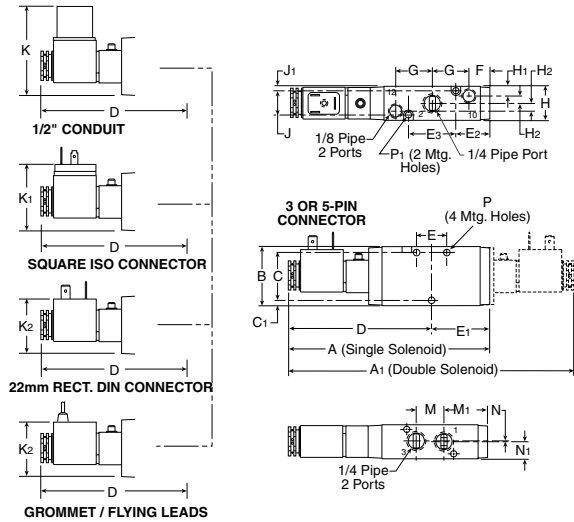

P2LBX 3/2 (solenoid)

A	A ₁	B	C	C ₁
5.35 (136)	7.60 (193)	1.57 (40)	1.26 (32)	.16 (4)
D	E	E ₁	E ₂	E ₃
3.80 (96.5)	.79 (20)	1.54 (39)	.51 (13)	1.26 (32)
F	G	H	H ₁	H ₂
.55 (14)	.98 (25)	.87 (22)	.26 (6.6)	.18 (4.5)
J	J ₁	K	K ₁	K ₂
.65 (16.5)	.11 (2.9)	2.36 (60)	1.61 (41)	1.50 (38)
M	M ₁	N	N ₁	P
.79 (20)	1.14 (29)	.02 (0.5)	.42 (11)	Ø .17 Ø (4.3)
P₁ Ø .12 Ø (3.1)				
Inches (mm)				

P2LBX 3/2 Single & Double Operators – Remote Pilot

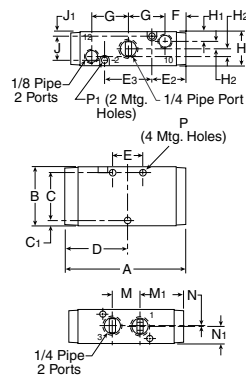

P2LBX 3/2 (remote)

A	B	C	C ₁	D
3.08 (78)	1.57 (40)	1.26 (32)	.16 (4)	1.54 (39)
E	E ₂	E ₃	F	G
.79 (20)	.51 (13)	1.26 (32)	.55 (14)	.98 (25)
H	H ₁	H ₂	J	J ₁
.87 (22)	.26 (6.6)	.18 (4.5)	.65 (16.5)	.11 (2.9)
M	M ₁	N	N ₁	P
.79 (20)	1.14 (29)	.02 (0.5)	.42 (11)	Ø .17 Ø (4.3)
P₁ Ø .12 Ø (3.1)				
Inches (mm)				

P2LBX 5/2 & 5/3 Single & Double Operators – Solenoid

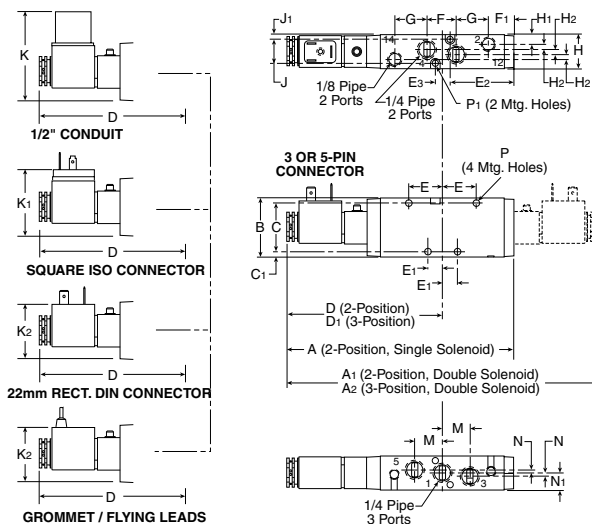

P2LBX 5/2 & 5/3 (solenoid)

A	A ₁	A ₂	B	C
6.14 (156)	8.39 (213)	9.23 (235)	1.57 (40)	1.26 (32)
C ₁	D	D ₁	E	E ₁
.16 (4)	4.21 (107)	4.64 (118)	.91 (23)	.39 (10)
E ₂	E ₃	F	F ₁	G
1.73 (44)	.39 (10)	.79 (20)	.67 (17)	.87 (22)
H	H ₁	H ₂	J	J ₁
.87 (22)	.26 (6.6)	.12 (3)	.65 (16.5)	.12 (3)
K	K ₁	K ₂	M	N
2.36 (60)	1.61 (41)	1.50 (38)	.79 (20)	.08 (2)
N ₁	P	P ₁		
.43 (11)	Ø .17 Ø (4.3)	Ø .12 Ø (3.1)		
Inches (mm)				



P2LBX 5/2 & 5/3 Single & Double Operators – Remote Pilot

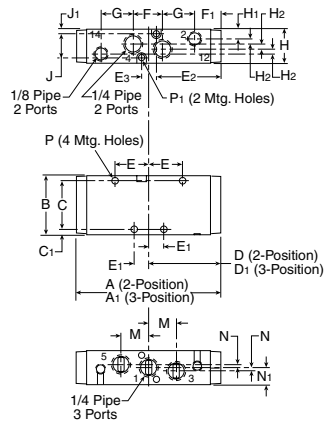

P2LBX 5/2 & 5/3 (remote)

A	A₁	B	C	C₁
3.95 (100)	4.61 (117)	1.57 (40)	1.26 (32)	.16 (4)
D	D₁	E	E₁	E₂
1.93 (49)	2.28 (58)	.91 (23)	.39 (10)	1.73 (44)
E₃	F	F₁	G	H
.39 (10)	.79 (20)	.67 (17)	.87 (22)	.8 (22)
H₁	H₂	J	J₁	K
.26 (6.6)	.12 (3)	.65 (16.5)	.11 (2.8)	2.90 (74)
M	N	N₁	P	P₁
.79 (20)	.08 (2)	.43 (11)	∅ .17 ∅ (4.3)	∅ .12 ∅ (3.1)

Inches (mm)

P2LBX 5/2 Single & Double Operators – Solenoid _ NAMUR

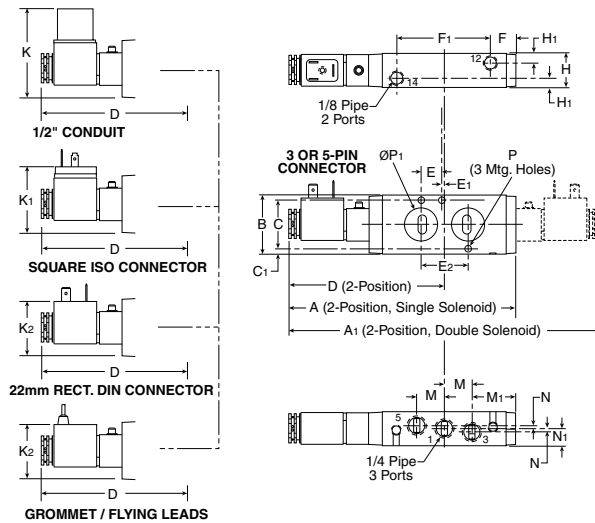

P2LBX 5/2 (NAMUR)

A	A₁	B	C	C₁
6.15 (156)	8.39 (213)	1.57 (40)	1.26 (32)	.16 (4)
D	E	E₁	E₂	F
4.21 (107)	.47 (12)	.08 (2)	.94 (24)	.67 (17)
F₁	H	H₁	M	M₁
2.52 (64)	.87 (22)	.26 (6.6)	.79 (20)	1.14 (29)
N	N₁	P	P₁	
.08 (2)	.43 (11)	∅ .22 ∅ (5.5)	∅ .76 ∅ (19.4)	

Inches (mm)

P2LBX 3/2 Single & Double Operators – IEM Aluminum Bar Manifold

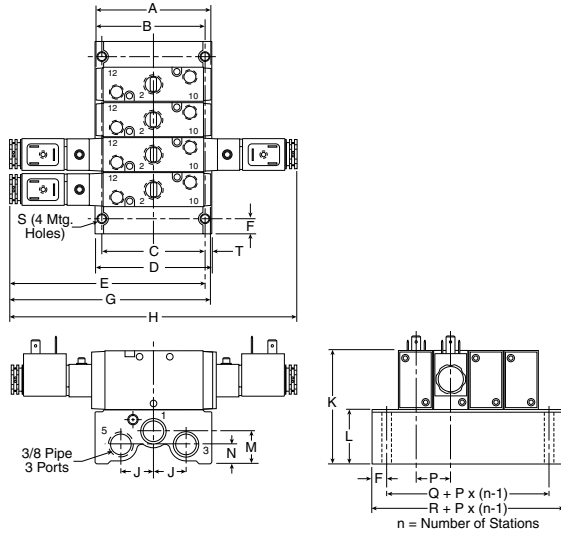

P2LBX 3/2
IEM Aluminum bar manifold

A	B	C	D	E
3.86 (78)	2.91 (74)	2.76 (70)	3.12 (79)	5.17 (131)
F	G	H	J	K
.40 (10.2)	5.33 (136)	7.6 (193)	.87 (22)	3.11 (79)
L	M	N	P	Q
1.47 (37)	.87 (22)	.52 (13.2)	.93 (23.5)	1.56 (39.6)
R	S	T		
2.36 (60)	Ø .22 (5.5)	.18 (4.6)		

Inches (mm)

P2LBX 5/2 & 5/3 Single & Double Operators – IEM Aluminum Bar Manifold

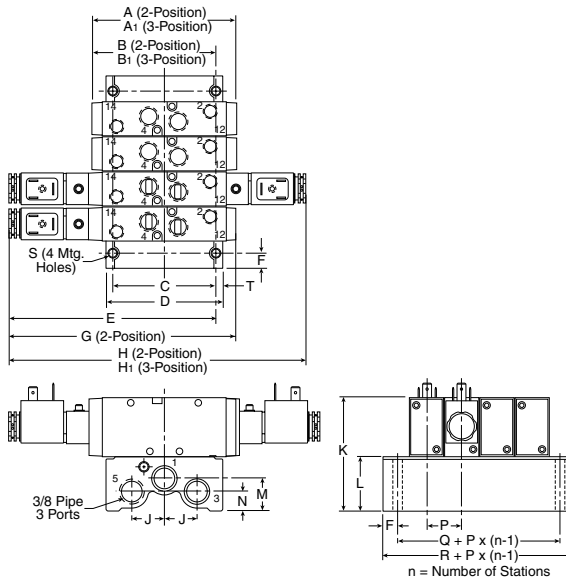

P2LBX 5/2 & 5/3
IEM Aluminum bar manifold

A	A ₁	B	B ₁	C
3.86 (98)	4.70 (120)	3.42 (84)	3.73 (95)	2.76 (70)
D	E	F	G	H
3.12 (79)	5.59 (142)	.40 (10.2)	6.14 (156)	8.39 (213)
H ₁	J	K	L	M
9.23 (235)	.87 (22)	3.11 (79)	1.47 (37)	.87 (22)
N	P	Q	R	S
.52 (13.2)	.93 (23.5)	1.56 (39.6)	2.36 (60)	Ø .22 (5.5)
T				
.18 (4.6)				

Inches (mm)

P2LCX 3/2 Single & Double Operators – Solenoid

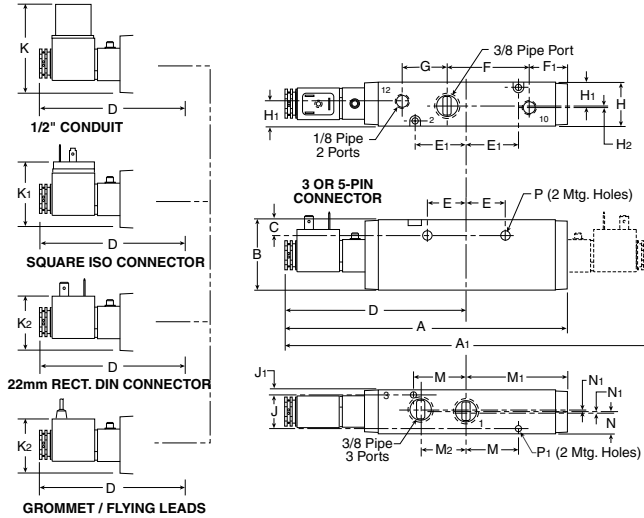

P2LCX 3/2 (solenoid)

A	A₁	B	C	D
7.66 (194.5)	9.80 (249)	1.89 (48)	.43 (11)	4.90 (124.5)
E	E₁	F	F₁	G
1.04 (26.5)	1.40 (35.5)	2.24 (57)	1.02 (26)	1.22 (31)
H	H₁	H₂	J	J₁
1.18 (30)	.67 (17)	.02 (0.5)	.91 (23)	.14 (3.5)
K	K₁	K₂	M	M₁
2.52 (64)	1.77 (45)	1.65 (42)	1.40 (35.5)	2.76 (70)
M₂	N	N₁	P	P₁
1.18 (30)	.55 (14)	.04 (1)	∅ .27 ∅ (6.9)	∅ .17 ∅ (4.4)

Inches (mm)

P2LCX 3/2 Single & Double Operators – Remote Pilot

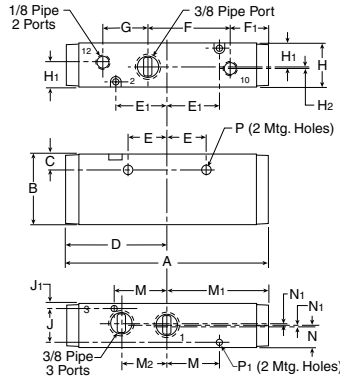

P2LCX 3/2 (remote)

A	B	C	D	E
5.51 (140)	1.89 (48)	.43 (11)	2.76 (70)	1.04 (26.5)
E₁	F	F₁	G	H
1.40 (35.5)	2.24 (57)	1.02 (26)	1.22 (31)	1.18 (30)
H₁	H₂	J	J₁	M
.67 (17)	.02 (0.5)	.91 (23)	.14 (3.5)	1.40 (35.5)
M₁	M₂	N	N₁	P
2.76 (70)	1.18 (30)	.55 (14)	.04 (1)	∅ .27 ∅ (6.9)

P₁
∅ .17
∅ (4.4)

Inches (mm)

P2LCX 5/2 & 5/3 Single & Double Operators – Solenoid

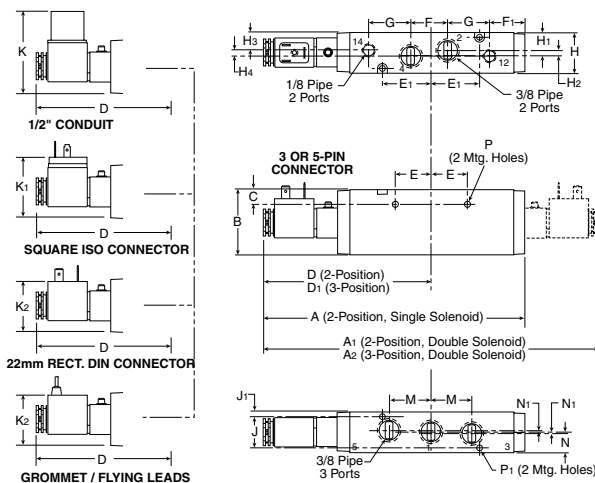

P2LCX 5/2 & 5/3 (solenoid)

A	A₁	A₂	B	C
7.68 (195)	9.84 (250)	10.71 (272)	1.89 (48)	.43 (11)
D	D₁	E	E₁	F
4.92 (125)	5.35 (136)	1.04 (26.5)	1.40 (35.5)	1.06 (27)
F₁	G	H	H₁	H₂
1.02 (26)	1.22 (31)	1.18 (30)	.53 (13.5)	.12 (3)
H₃	H₄	J	J₁	K
.51 (13)	.16 (4)	.91 (23)	.14 (3.5)	2.52 (64)
K₁	K₂	M	N	N₁
1.77 (45)	1.65 (42)	1.18 (30)	.55 (14)	.04 (1)

P ∅ .27
P₁ ∅ .17
∅ (6.9) ∅ (4.4)

Inches (mm)



P2LCX 5/2 & 5/3 Single & Double Operators – Remote Pilot

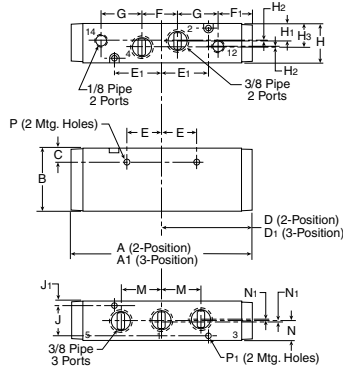

P2LCX 5/2 & 5/3 (remote)

A	A1	B	C	D
5.51 (140)	6.38 (162)	1.89 (48)	.43 (11)	2.76 (70)
D1	E	E1	F	F1
3.18 (81)	1.04 (26.5)	1.40 (35.5)	1.06 (27)	1.02 (26)
G	H	H1	H2	H3
1.22 (31)	1.18 (30)	.51 (13)	.02 (0.5)	.12 (3)
J	J1	M	N	N1
.91 (23)	.14 (3.5)	1.18 (30)	.55 (14)	.04 (1)
P	P1			
Ø .27 Ø (6.9)	Ø .17 Ø (4.4)			

Inches (mm)

P2LCX 3/2 Single & Double Operators – IEM Aluminum Bar Manifold

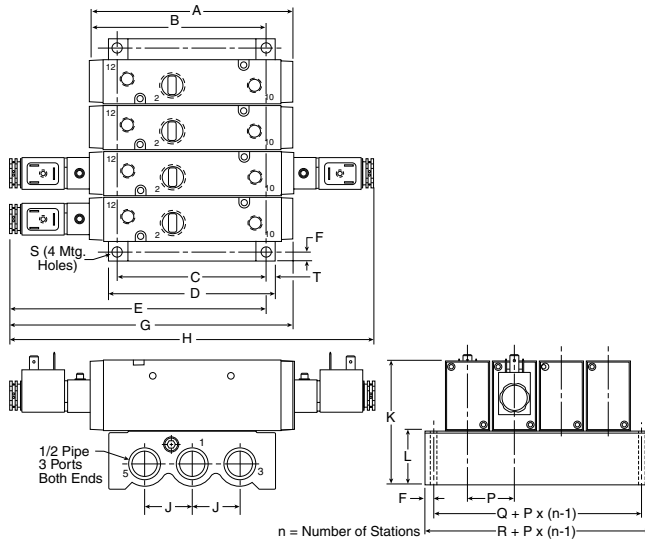

P2LCX 3/2

IEM Aluminum bar manifold

A	B	C	D	E
5.51 (140)	4.96 (126)	3.94 (100)	4.41 (112)	7.11 (180.5)
F	G	H	J	K
.24 (6)	7.66 (194.5)	9.80 (249)	1.26 (32)	3.43 (87)
L	P	Q	R	S
1.54 (39)	1.24 (31.5)	1.77 (45)	2.24 (57)	Ø .26 Ø (6.5)
T				
.24 (6)				

Inches (mm)

P2LCX 5/2 & 5/3 Single & Double Operators – IEM Aluminum Bar Manifold

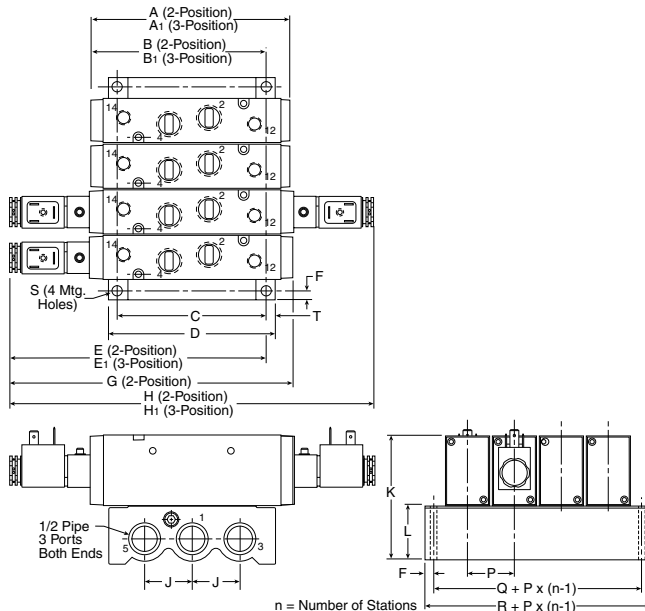

P2PCX 5/2 & 5/3

IEM Aluminum bar manifold

A	A1	B	B1	C
5.51 (140)	6.38 (162)	4.72 (120)	5.16 (131)	3.94 (100)
D	E	E1	F	G
4.41 (112)	6.89 (170)	7.13 (181)	.24 (6)	7.68 (195)
H	H1	J	K	L
9.84 (250)	10.71 (272)	1.26 (32)	3.43 (87)	1.54 (39)
P	Q	R	S	T
1.24 (31.5)	1.77 (45)	2.24 (57)	Ø .26 Ø (6.5)	.24 (6)

Inches (mm)



P2LDX 3/2 Single & Double Operators – Solenoid

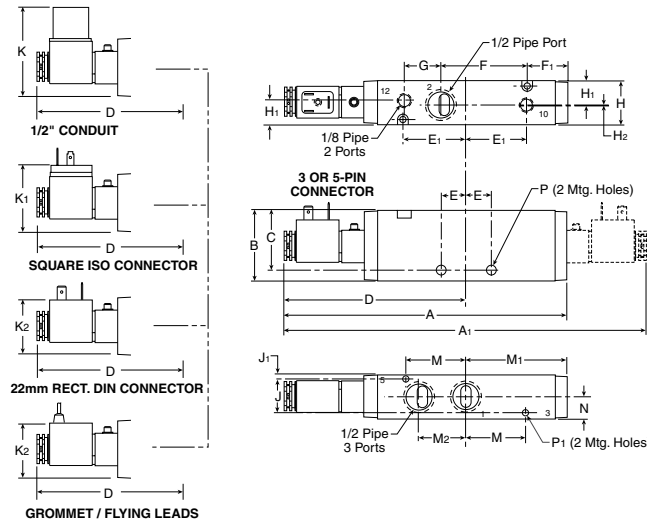

P2LDX 3/2 (solenoid)

A	A ₁	B	C	D
7.66 (194.5)	9.80 (249)	1.89 (48)	1.59 (40.5)	4.90 (124.5)
E	E ₁	F	F ₁	G
.67 (17)	1.65 (42)	2.36 (60)	1.08 (27.5)	.98 (25)
H	H ₁	H ₂	J	J ₁
1.18 (30)	.67 (17)	.02 (0.5)	.91 (23)	.14 (3.5)
K	K ₁	K ₂	M	M ₁
2.52 (64)	1.77 (45)	1.65 (42)	1.65 (42)	2.76 (70)
M ₂	N	P	P ₁	
1.30 (33)	.59 (15)	Ø .26 Ø (6.6)	Ø .17 Ø (4.4)	

Inches (mm)

P2LDX 3/2 Single & Double Operators – Remote Pilot

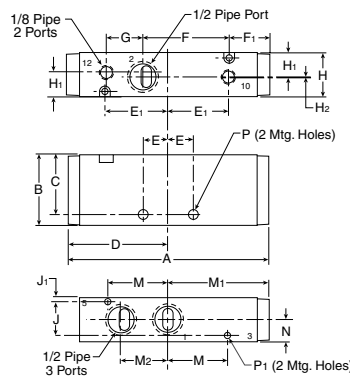

P2LDX 3/2 (remote)

A	B	C	D	E
5.51 (140)	1.89 (48)	1.59 (40.5)	2.76 (70)	.67 (17)
E ₁	F	F ₁	G	H
1.65 (42)	2.36 (60)	1.08 (27.5)	.98 (25)	1.18 (30)
H ₁	H ₂	J	J ₁	M
.67 (17)	.02 (0.5)	.91 (23)	.14 (3.5)	1.65 (42)
M ₁	M ₂	N	P	P ₁
2.76 (70)	1.30 (33)	.59 (15)	Ø .26 Ø (6.6)	Ø .17 Ø (4.4)

Inches (mm)

P2LDX 5/2 & 5/3 Single & Double Operators – Solenoid

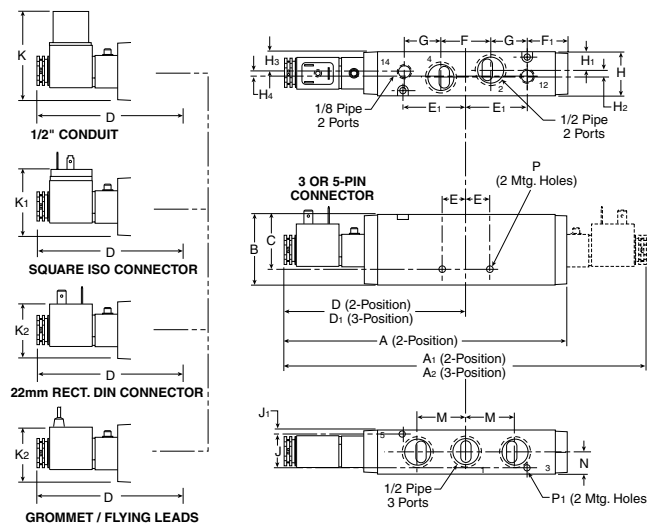

P2LDX 5/2 & 5/3 (solenoid)

A	A ₁	A ₂	B	C
7.67 (195)	9.84 (250)	10.7 (272)	1.89 (48)	1.59 (40.5)
D	D ₁	E	E ₁	F
4.92 (125)	5.79 (147)	.67 (17)	1.65 (42)	1.34 (34)
F ₁	G	H	H ₁	H ₂
1.10 (28)	.98 (25)	1.18 (30)	.49 (12.5)	.20 (5)
H ₃	H ₄	J	J ₁	K
.51 (13)	.16 (4)	.91 (23)	.14 (3.5)	2.52 (64)
K ₁	K ₂	M	N	P
1.77 (45)	1.65 (42)	1.30 (33)	.59 (15)	Ø .26 Ø (6.6)

P₁
Ø .17
Ø (4.4)

Inches (mm)



P2LDX 5/2 & 5/3 Single & Double Operators – Remote Pilot

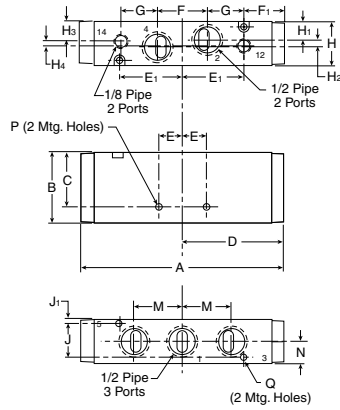

P2LDX 5/2 & 5/3 (remote)

A	B	C	D	E
5.47 (139)	1.89 (48)	1.59 (40.5)	2.63 (67)	.67 (17)
E1	F	F1	G	H
1.65 (42)	1.34 (34)	1.08 (27.5)	.98 (25)	1.18 (30)
H1	H2	H3	H4	J
.49 (12.5)	.20 (5)	.51 (13)	.16 (4)	.91 (23)
J1	P	M	N	Q
.14 (3.5)	Ø .26 Ø (6.6)	1.29 (32.7)	.59 (15)	Ø .17 Ø (4.4)

Inches (mm)

Parker Pneumatic

**Viking Xtreme Manual Valves
Air Control Valves**

The Viking Xtreme Manual valve range is robust, versatile and combines high performance with compact installation dimensions. The valves rugged lever actuator has been specifically designed for gloved hands to suit mobile applications in the most arduous of environments. Available in 3/2, 5/2 and 5/3 functions with either spring return or detented lever. The lever actuated versions are available across the entire range from 1/8 to 1/2 port sizes.

Heavy duty lever

Inline valve

- 1/8", 1/4", 3/8", 1/2" NPT & BSPP

2-position models

- 4-way & 3-way

3-position models

- all ports blocked
- pressure center
- center exhaust

Over-moulded single piece aluminium spool

- Reduced product complexity
- Increased flow
- Wide operating temperature range
- Stable seal performance even with high flow / pressure drop across spool.



Operating information

Operating pressure: Type A & B: Vacuum to 232 PSIG (Vacuum to 16 bar Max.)

Type C & D: Vacuum to 174 PSIG (Vacuum to 12 bar Max.)

Temperature range: Xtreme: -40°F to 140°F (-40°C to 60°C)

Material specifications

End covers	Anodized aluminum
Lever	Reinforced polyamide plastic
Lever housing	Acetal plastic
Piston	Acetal plastic / anodized aluminum
Seals	Nitrile rubber
Screws	Stainless steel
Spool	Aluminum & nitrile rubber
Springs	Stainless steel
Valve body	Anodized aluminum

**Lever Handle –
1/8" valve size,
5/2 & 5/3 only**



**Twist Handle –
1/4" valve sizes**



**Lever Handle –
All other valve
sizes**



Features

- Variety of manual actuators
- Robust Knobs
- Stainless steel shafts
- Handle boots for ingress protection

Over Molded Spool

- Aluminum spool with nitrile rubber coating ground to exact size for optimum performance
- Precision ground for maximum performance
- Wide operating temperature range - Low temperature to -40°

Robust anodized aluminum valve body



Diecast end covers with stainless steel screws to resist aggressive environments.



Sintered bronze pilot chamber breathers provide increased protection against ingress of dust and dirt.

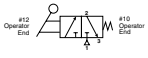

Stainless steel return spring

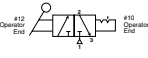

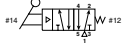

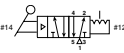
The bore is polished to a very high surface finish for maximum flow capacity and long life.

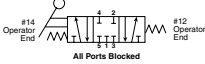

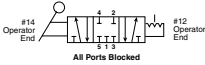
3/2 - 2-position	Symbol	Valve type	Port size	Cv	Weight lb (kg)	Part number NPT	Part number BSPP
		Lever spring return	1/8	0.6	0.73 (0.33)	P2LAX391VS	P2LAX311VS
			1/4	1.5	0.73 (0.33)	P2LBX392VS	P2LBX312VS
			3/8	2.5	0.88 (0.40)	P2LCX393VS	P2LCX313VS
			1/2	2.7	1.32 (0.60)	P2LDX394VS	P2LDX314VS
		Lever detent	1/8	0.7	0.73 (0.33)	P2LAX391VV	P2LAX311VV
			1/4	1.3	0.73 (0.33)	P2LBX392VV	P2LBX312VV
			3/8	2.5	0.88 (0.40)	P2LCX393VV	P2LCX313VV
			1/2	2.7	1.32 (0.60)	P2LDX394VV	P2LDX314VV

5/2 - 2-position	Symbol	Valve type	Port size	Cv	Weight lb (kg)	Part number NPT	Part number BSPP
		Lever spring return	1/8	0.6	0.40 (0.18)	P2LAX591VS	P2LAX511VS
			1/4	1.5	0.73 (0.33)	P2LBX592VS	P2LBX512VS
			3/8	2.5	0.88 (0.40)	P2LCX593VS	P2LCX513VS
			1/2	2.7	1.32 (0.60)	P2LDX594VS	P2LDX514VS
		Lever detent	1/8	0.7	0.40 (0.18)	P2LAX591VV	P2LAX511VV
			1/4	1.3	0.73 (0.33)	P2LBX592VV	P2LBX512VV
			3/8	2.5	0.88 (0.40)	P2LCX593VV	P2LCX513VV
			1/2	2.7	1.32 (0.60)	P2LDX594VV	P2LDX514VV







5/3 - 3-position, all ports blocked	Symbol	Valve type	Port size	Cv	Weight lb (kg)	Part number NPT	Part number BSPP
		Lever spring center	1/8	0.6	0.40 (0.18)	P2LAX69111	P2LAX61111
			1/4	1.5	0.73 (0.33)	P2LBX69211	P2LBX61211
			3/8	2.5	1.56 (0.71)	P2LCX69311	P2LCX61311
			1/2	2.7	1.61 (0.73)	P2LDX69411	P2LDX61411
		Lever detent	1/8	0.7	0.40 (0.18)	P2LAX69122	P2LAX61122
			1/4	1.3	0.73 (0.33)	P2LBX69222	P2LBX61222
			3/8	2.5	1.56 (0.71)	P2LCX69322	P2LCX61322
			1/2	2.7	1.61 (0.73)	P2LDX69422	P2LDX61422

5/3 - 3-position, pressure center	Symbol	Valve type	Port size	Cv	Weight lb (kg)	Part number NPT	Part number BSPP
		Lever spring center	1/8	0.6	0.40 (0.18)	P2LAX79111	P2LAX71111
			1/4	1.5	0.73 (0.33)	P2LBX79211	P2LBX71211
			3/8	2.5	1.56 (0.71)	P2LCX79311	P2LCX71311
			1/2	2.7	1.61 (0.73)	P2LDX79411	P2LDX71411
		Lever detent	1/8	0.7	0.40 (0.18)	P2LAX79122	P2LAX71122
			1/4	1.3	0.73 (0.33)	P2LBX79222	P2LBX71222
			3/8	2.5	1.56 (0.71)	P2LCX79322	P2LCX71322
			1/2	2.7	1.61 (0.73)	P2LDX79422	P2LDX71422

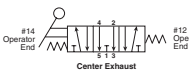
 Most popular.

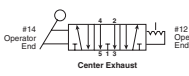

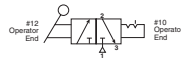
Parker Pneumatic

5/3 - 3-position, center exhaust	Symbol	Valve type	Port size	Cv	Weight lb (kg)	Part number NPT	Part number BSPP
		Lever spring center	1/8	0.6	0.40 (0.18)	P2LAX89111	P2LAX81111
			1/4	1.5	0.73 (0.33)	P2LBX89211	P2LBX81211
			3/8	2.5	1.56 (0.71)	P2LCX89311	P2LCX81311
			1/2	2.7	1.61 (0.73)	P2LDX89411	P2LDX81411
		Lever detent	1/8	0.7	0.40 (0.18)	P2LAX89122	P2LAX81122
			1/4	1.3	0.73 (0.33)	P2LBX89222	P2LBX81222
			3/8	2.5	1.56 (0.71)	P2LCX89322	P2LCX81322
			1/2	2.7	1.61 (0.73)	P2LDX89422	P2LDX81422
<hr/>							
3/2 - 2-position	Symbol	Valve type	Port size	Cv		Part number NPT	Part number BSPP
		Twist handle detent	1/4	1.3	0.73 (0.33)	P2LBX392JJ	P2LBX312JJ
<hr/>							
5/2 - 2-position	Symbol	Valve type	Port size	Cv		Part number NPT	Part number BSPP
		Twist handle detent	1/4	1.3	0.73 (0.33)	P2LBX592JJ	P2LBX512JJ

Manual Operated Valves

Vacuum to 232 PSIG (Vacuum to 16 bar) -40°F to 158°F (-40°C to 70°C)

P2L A X 5 91 VS

Valve size	
1/8"	A
1/4"	B
3/8"	C
1/2"	D

Valve type / function	
3/2 NC - 2-position	3
5/2 2-position	5
5/3 3-position, APB	6
5/3 3-position, PC	7
5/3 3-position, CE	8

Actuator / return	
JJ*	Twist handle detent, 2-position
VS	Spring return lever, 2-position, 90° to ports
VV	Lever, detent, 2-position, 90° to ports
11	Spring centered lever, 3-position, 90° to ports
22	Lever, detent, 3-position, 90° to ports

* Not available with 3-position valves. Available Size B only.

Main port thread	
11	G1/8 (P2LA)
12	G1/4 (P2LB)
13	G3/8 (P2LC)
14	G1/2 (P2LD)
91	1/8" NPT (P2LA)
92	1/4" NPT (P2LB)
93	3/8" NPT (P2LC)
94	1/2" NPT (P2LD)

NOTE: For ATEX certified remote air pilot valves, build the valve part number from the model number index for remote pilot and add "-EX" following the number.

Example: P2LAX591PS-EX

 Most popular.



Exhaust Mufflers

Pipe thread	Part number
M5	P6M-PAC5
1/8" NPT	EM12
1/4" NPT	EM25
3/8" NPT	EM37
1/2" NPT	EM50

P6M - Plastic; EM - Sintered bronze



Plastic Silencers

Thread size	Part number		A (mm)	B (mm)
	NPT	BSPT		
M5	AS-5		.43 (11)	.32 (8)
1/8"	ASN-6	AS-6	1.57 (40)	.63 (16)
1/4"	ASN-8	AS-8	2.56 (65)	.83 (21)
3/8"	ASN-10	AS-10	3.35 (85)	.98 (25)
1/2"	ASN-15	AS-15	3.74 (95)	1.18 (30)



Exhaust Protector

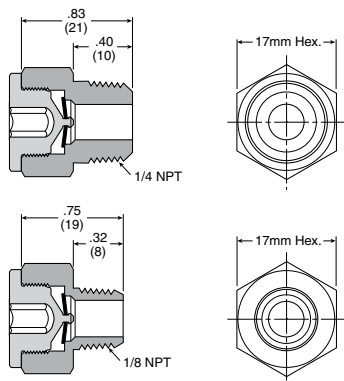

Features

- 1/8 and 1/4 NPT male sizes
- Fitted with a brass pipe adapter and a fluorocarbon membrane
- Resistant to rust, clog, wash down and contamination

Applications

These protectors are intended for mobile applications, quick venting applications and alternative exhaust port breathers that require protection against clogging.

Ideal for valves exposed to harsh environmental conditions (which can cause a “caking up” in the exhaust pipe ports where the bronze mufflers or breather vents are installed).

Particularly suitable for time-sensitive applications such as axle-lift suspensions or pushers or tag axles.

Specifications

Operating pressure 0 – 150 PSIG
..... (0 to 10 bar, 0 to 1034 kPa)

Operating temperature -40°F to 158°F (-40°C to 70°C)

Material:

Body and pipe adapter Brass
Membrane..... Fluorocarbon

Flow Data (SCFM)

Part number	Size	60 PSIG inlet	90 PSIG inlet	125 PSIG inlet
E90016	1/8"	40.1	56.5	75.5
E90017	1/4"	44.6	62.7	83.5

P2LAX 3/2 Hand Lever Operated

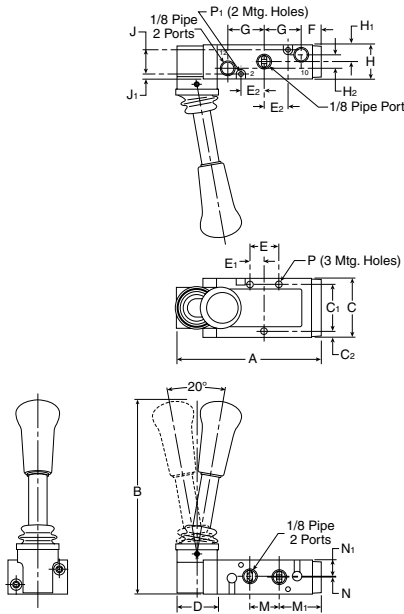

**P2LAX 3/2
(hand lever)**

A	B	C
3.88 (99)	5.23 (133)	1.57 (40)
C ₁	C ₂	D
1.26 (32)	.16 (4)	1.06 (27)
E	E ₁	E ₂
.79 (20)	.39 (10)	.63 (16)
F	G	H
.55 (14)	.98 (25)	.87 (22)
H ₁	H ₂	J
.42 (10.6)	.02 (0.5)	.65 (16.5)
J ₁	M	M ₁
.11 (2.9)	.79 (20)	1.14 (29)
N	N ₁	P
.18 (4.5)	.26 (6.6)	∅ .17 (∅ 4.3)
P ₁	∅ .12 (∅ 3.1)	

Inches (mm)

P2LAX 5/2 & 5/3 Hand Lever Operated

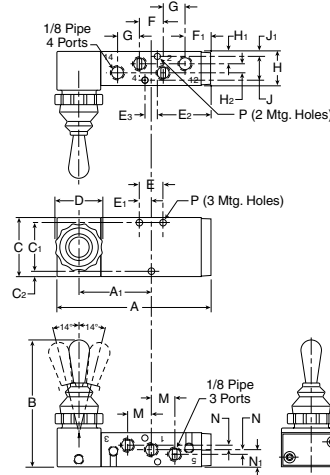

**P2LAX 5/2 & 5/3
(hand lever)**

A	A ₁	B
4.02 (102)	1.89 (48)	3.23 (82)
C	C ₁	C ₂
1.57 (40)	1.30 (33)	.14 (3.5)
D	E ₂	E ₃
1.18 (30)	1.42 (36)	.33 (8.5)
F	F ₁	G
.63 (16)	.67 (17)	.59 (15)
H	H ₁	H ₂
.87 (22)	.31 (8)	.24 (6)
J	J ₁	M
.63 (16)	.12 (3)	.63 (16)
N	N ₁	P
.12 (3)	.43 (11)	∅ .16 (∅ 4.1)

Inches (mm)

P2LBX 3/2 Hand Lever Operated

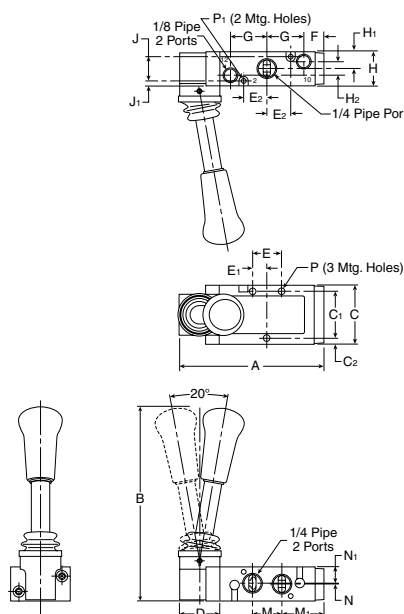

**P2LBX 3/2
(hand lever)**

A	B	C
3.88 (99)	5.23 (133)	1.57 (40)
C ₁	C ₂	D
1.26 (32)	.16 (4)	1.06 (27)
E	E ₁	E ₂
.79 (20)	.39 (10)	.63 (16)
F	G	H
.55 (14)	.98 (25)	.87 (22)
H ₁	H ₂	J
.42 (10.6)	.02 (0.5)	.65 (16.5)
J ₁	M	M ₁
.11 (2.9)	.79 (20)	1.14 (29)
N	N ₁	P
.18 (4.5)	.26 (6.6)	∅ .17 (∅ 4.3)
P ₁	∅ .12 (∅ 3.1)	

Inches (mm)

P2LBX 5/2 & 5/3 Hand Lever Operated

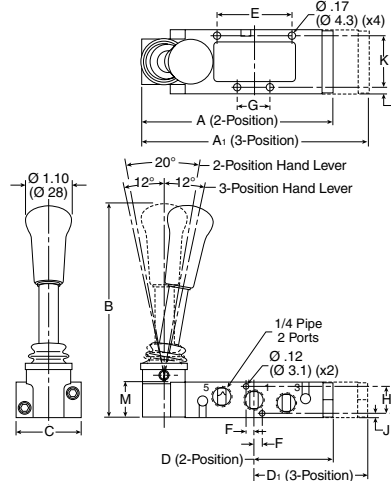

**P2LBX 5/2 & 5/3
(hand lever)**

A	A ₁	B	
4.67 (118.5)	5.51 (140)	5.19 (131.8)	
C	D	D ₁	
1.57 (40)	1.93 (49)	2.35 (59.8)	
E	F	G	
1.81 (46)	.20 (5)	.79 (20)	
H	J	K	
.65 (16.5)	.11 (2.85)	1.26 (32)	
L	M		
.16 (4)	.87 (22.2)		

Inches (mm)

P2LCX 3/2 Hand Lever Operated

P2LCX 3/2 (hand lever)

A	B	C
6.20 (158)	5.36 (136)	1.89 (48)
C ₁	D	E
.43 (11)	1.06 (27)	2.76 (70)
E ₁	E ₂	F
1.04 (27)	1.40 (36)	1.02 (26)
G	G ₁	H
1.22 (31)	2.24 (57)	1.18 (30)
H ₁	H ₂	J
.67 (17)	.02 (0.5)	.91 (23)
J ₁	M	M ₁
.14 (3.5)	1.18 (30)	2.76 (70)
N	N ₁	P
.59 (15)	.04 (1)	∅ .27 (∅ 6.9)
P₁ ∅ .17 ∅ (4.4)		

Inches (mm)

P2LCX 5/2 & 5/3 Hand Lever Operated

P2LCX 5/2 & 5/3 (hand lever)

A	A ₁	B
6.20 (157.5)	7.07 (179.5)	5.36 (136.3)
C	D	D ₁
1.89 (48)	2.76 (70)	3.19 (81)
E	F	H
2.09 (53)	1.40 (35.5)	.91 (23)
J	K	M
.14 (3.5)	.43 (11)	1.18 (30)

Inches (mm)

P2LDX 3/2 Hand Lever Operated

P2LDX 3/2 (hand lever)

A	B	C
6.20 (158)	5.36 (136)	1.89 (48)
C ₁	D	E
.30 (7.5)	1.06 (27)	2.76 (70)
E ₁	E ₂	F
.67 (17)	1.65 (42)	1.08 (28)
G	G ₁	H
.98 (25)	2.36 (60)	1.18 (30)
H ₁	H ₂	J
.67 (17)	.02 (0.5)	.91 (23)
J ₁	M	M ₁
.14 (3.5)	1.30 (33)	2.76 (70)
N	N ₁	P
.59 (15)	.04 (1)	∅ .26 (∅ 6.6)
P₁ ∅ .17 ∅ (4.4)		

Inches (mm)

P2LDX 5/2 & 5/3 Hand Lever Operated

P2LDX 5/2 & 5/3 (hand lever)

A	A ₁	B
6.20 (157.5)	7.07 (179.5)	5.36 (136.3)
C	D	D ₁
1.89 (48)	3.19 (81)	2.76 (70)
E	F	H
1.34 (34)	1.65 (42)	.91 (23)
J	K	M
.14 (3.5)	.30 (7.5)	1.18 (30)

Inches (mm)



Parker Pneumatic

P2LBX 3/2 Twist Lever Operated

**P2LBX 3/2
(hand lever)**

A	B	C
5.67 (144)	1.79 (45.5)	1.57 (40)
C ₁	C ₂	D
1.26 (32)	.16 (4)	2.87 (73)
E	E ₁	E ₂
.79 (20)	.39 (10)	.63 (16)
F	G	H
.55 (14)	.98 (25)	.87 (22.2)
H ₁	H ₂	J
.44 (11.1)	.26 (6.6)	.65 (16.5)
J ₁	M	M ₁
.11 (2.9)	.79 (20)	1.14 (29)
N	N ₁	P
.02 (0.5)	.42 (10.6)	∅ .17 ∅ (4.3)
P ₁	Q	R
∅ .12 ∅ (3.1)	1.5R (38.1)R	1.85 (47)
S	T	
1.10 (28)	.67 (17)	

Inches (mm)

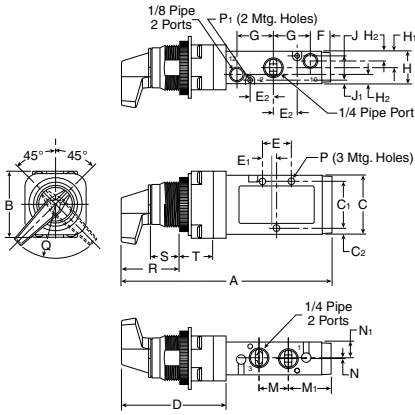

P2LBX 5/2 Twist Lever Operated

**P2LBX 5/2
(hand lever)**

A	B	C
6.46 (164)	1.79 (45.5)	1.57 (40)
C ₁	C ₂	D
1.26 (32)	.15 (4)	2.87 (73)
E	E ₁	E ₂
.91 (23)	.39 (10)	.20 (5)
F	G	G ₁
.67 (17)	.87 (22)	.79 (20)
H	H ₁	H ₂
.87 (22.2)	.44 (11.1)	.26 (6.6)
H ₃	J	J ₁
.12 (3)	.65 (16.5)	.11 (2.9)
M	N	N ₁
1.93 (49)	.08 (0.2)	.44 (11.1)
P	P ₁	Q
∅ .17 ∅ (4.3)	∅ .12 ∅ (3.1)	1.5R (38.1)R
R	S	T
1.85 (47)	1.10 (28)	.67 (17)

Inches (mm)

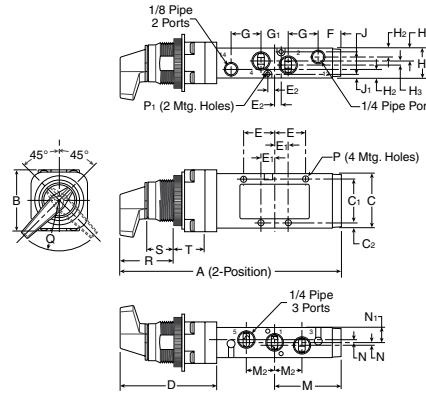

Panel Cutout Detail (All Port Sizes)

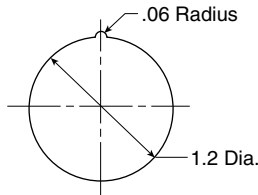

68PM Male Connector

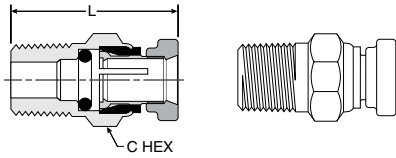

Part number	Tube size	Pipe thread (NPTF)	C hex	L
68PM-2-1	1/8	1/16	3/82	0.93
68PM-2-2	1/8	1/8	7/16	0.88
68PM-5/32-1	5/32	1/16	3/8	0.95
68PM-5/32-2	5/32	1/8	7/16	0.74
68PM-5/32-4	5/32	1/4	9/16	0.99
68PM-3-1	3/16	1/16	7/16	0.95
68PM-3-2	3/16	1/8	7/16	0.92
68PM-3-4	3/16	1/4	9/16	1.10

68PMT Male Connector

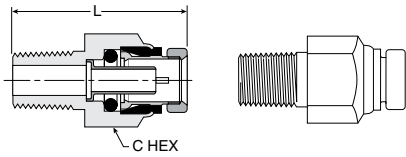

Part number	Tube size	Pipe thread (NPTF)	C hex	L
68PMT-4-2	1/4	1/8	1/2	1.06
68PMT-4-4	1/4	1/4	9/16	1.19
68PMT-4-6	1/4	3/8	3/4	1.27
68PMT-6-2	3/8	1/8	3/4	1.37
68PMT-6-4	3/8	1/4	3/4	1.43
68PMT-6-6	3/8	3/8	3/4	1.33
68PMT-6-8	3/8	1/2	7/8	1.38
68PMT-8-4	1/2	1/4	7/8	1.72
68PMT-8-6	1/2	3/8	7/8	1.52
68PMT-8-8	1/2	1/2	7/8	1.44
68PMT-10-6	5/8	3/8	1	1.88
68PMT-10-8	5/8	1/2	1	1.88
68PMT-12-8	3/4	1/2	1-3/16	2.03

169PMNS Male Elbow Non-Swivel 90°

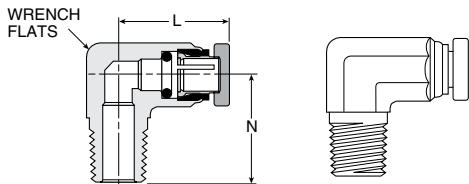

Part number	Tube size	Pipe thread (NPTF)	Wrench flats	L	N
169PMNS-2-2	1/8	1/8	3/8	0.86	0.68
169PMNS-5/32-2	5/32	1/8	3/8	0.88	0.68
169PMNS-3-2	3/16	1/8	3/8	0.75	0.67
169PMNS-3-4	3/16	1/4	1/2	0.74	0.93

169PMT Male Elbow Swivel 90°

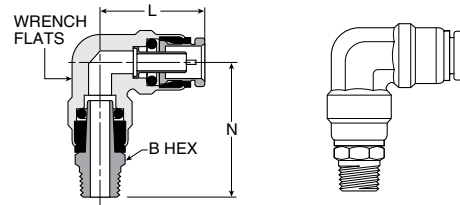

Part number	Tube size	Pipe Thread (NPTF)	Wrench flats	B hex	L	N
169PMT-4-2	1/4	1/8	13/32	7/16	0.84	1.21
169PMT-4-4	1/4	1/4	13/32	9/16	0.84	1.43
169PMT-4-6	1/4	3/8	13/32	11/16	0.84	1.43
169PMT-6-2	3/8	1/8	9/16	9/16	1.11	1.41
169PMT-6-4	3/8	1/4	9/16	9/16	1.11	1.58
169PMT-6-6	3/8	3/8	9/16	11/16	1.11	1.58
169PMT-6-8	3/8	1/2	9/16	7/8	1.11	1.79
169PMT-8-4	1/2	1/4	11/16	5/8	1.27	1.73
169PMT-8-6	1/2	3/8	11/16	3/4	1.27	1.81
169PMT-8-8	1/2	1/2	11/16	7/8	1.27	1.96
169PMT-10-6	5/8	3/8	7/8	3/4	1.53	2.03
169PMT-10-8	5/8	1/2	7/8	7/8	1.53	2.18

169PMTL Male Elbow Long Non-Swivel 90°

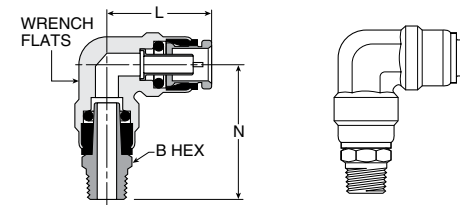

Part number	Tube size	Pipe Thread (NPTF)	Wrench flats	B hex	L	N
169PMTL-6-4	3/8	1/4	9/16	9/16	1.06	1.63
169PMTL-6-6	3/8	3/8	9/16	7/8	1.19	2.50
169PMTL-6-8	3/8	1/2	9/16	7/8	1.19	2.50
169PMTL-8-8	1/2	1/2	11/16	7/8	1.22	2.50
169PMTL-10-8	5/8	1/2	7/8	7/8	1.46	2.50

169PMTNS Male Elbow Non-Swivel 90°

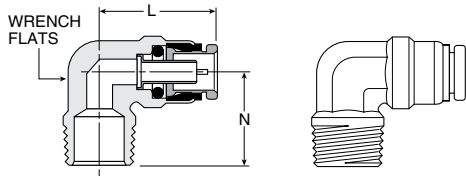

Part number	Tube size	Pipe thread (NPTF)	Wrench flats	L	N
169PMTNS-4-2	1/4	1/8	1/2	0.84	0.72
169PMTNS-4-4	1/4	1/4	1/2	0.84	0.90
169PMTNS-4-6	1/4	3/8	1/2	0.84	1.06
169PMTNS-6-2	3/8	1/8	9/16	1.05	0.75
169PMTNS-6-4	3/8	1/4	9/16	1.05	0.94
169PMTNS-6-6	3/8	3/8	3/4	1.05	0.94
169PMTNS-6-8	3/8	1/2	11/16	1.12	1.26
169PMTNS-8-4	1/2	1/4	11/16	1.17	1.06
169PMTNS-8-6	1/2	3/8	11/16	1.22	1.06
169PMTNS-8-8	1/2	1/2	11/16	1.22	1.26
169PMTNS-10-6	5/8	3/8	7/8	1.46	1.11
169PMTNS-10-8	5/8	1/2	7/8	1.46	1.32
169PMTNS-12-8	3/4	1/2	1	1.81	1.44

171PMT Male Run Tee Swivel

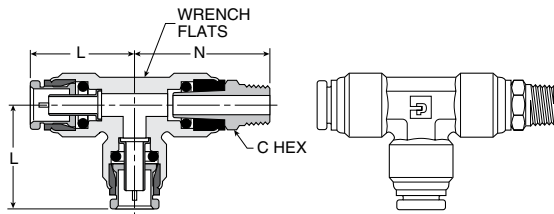

Part number	Tube size	Pipe thread (NPTF)	Wrench flats	L	N	N
171PMT-4-2	1/4	1/8	1/2	7/16	.85	1.25
171PMT-4-4	1/4	1/4	1/2	9/16	.85	1.48
171PMT-4-6	1/4	3/8	1/2	11/16	.85	1.43
171PMT-6-4	3/8	1/4	5/8	9/16	1.21	1.83
171PMT-6-6	3/8	3/8	5/8	11/16	1.21	1.83
171PMT-8-4	1/2	1/4	7/8	5/8	1.27	1.74
171PMT-8-6	1/2	3/8	7/8	3/4	1.27	1.83
171PMT-8-8	1/2	1/2	7/8	7/8	1.27	1.99

171PMTNS Male Run Tee Non-Swivel

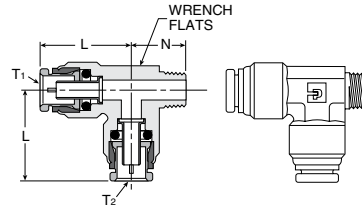

Part number	Tube 1 size	Tube 2 size	Pipe thread (NPTF)	Wrench flats	L1	L2	N
171PMTNS-4-4	1/4	1/4	1/4	15-32	0.91	0.91	0.94
171PMTNS-4-6-4	1/4	3/8	1/4	5/8	0.93	1.21	0.97
171PMTNS-6-4	3/8	3/8	1/4	5/8	1.21	1.21	0.97
171PMTNS-6-4-4	3/8	1/4	1/4	5/8	1.21	0.93	0.97
171PMTNS-6-4-6	3/8	1/4	3/8	5/8	1.22	0.97	0.93
171PMTNS-6-6	1/2	3/8	3/8	5/8	1.21	1.27	0.97
171PMTNS-6-8	1/2	3/8	1/2	5/8	1.17	1.27	1.26
171PMTNS-8-4	1/2	1/2	1/4	7/8	1.28	1.27	1.06

172PMT Male Branch Tee Swivel

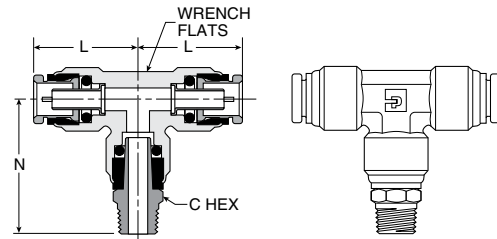

Part number	Tube size	Pipe thread (NPTF)	Wrench flats	C hex	L	N
172PMT-4-2	1/4	1/8	1/2	7/16	0.85	1.25
172PMT-4-4	1/4	1/4	1/2	9/16	0.85	1.43
172PMT-6-2	3/8	1/8	5/8	9/16	1.22	1.66
172PMT-6-4	3/8	1/4	5/8	5/8	1.22	1.83
172PMT-6-6	3/8	3/8	5/8	3/4	1.22	1.83
172PMT-8-4	1/2	1/4	7/8	5/8	1.27	1.73
172PMT-8-6	1/2	3/8	7/8	3/4	1.27	1.79
172PMT-8-8	1/2	1/2	7/8	7/8	1.27	1.97

172PMTNS Male Branch Tee Non-Swivel

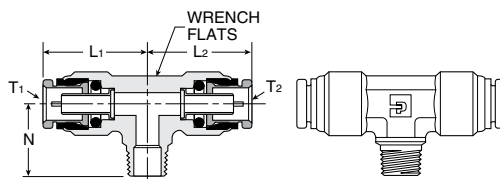

Part number	Tube 1 size	Tube 2 size	Pipe thread (NPTF)	Wrench flats	L1	L2	N
172PMTNS-4-2	1/4	1/4	1/8	1/2	0.91	0.91	0.78
172PMTNS-6-4	3/8	3/8	1/4	5/8	1.21	1.21	0.97
172PMTNS-6-4-4	3/8	1/4	1/4	5/8	1.21	.93	0.97
172PMTNS-6-6	3/8	3/8	3/8	5/8	1.21	1.21	0.97
172PMTNS-6-8	3/8	3/8	1/2	7/8	1.17	1.17	1.26
172PMTNS-8-6	1/2	1/2	3/8	7/8	1.28	1.28	1.06
172PMTNS-8-6-8	1/2	3/8	1/2	7/8	1.25	1.25	1.25
172PMTNS-8-8	1/2	1/2	1/2	7/8	1.34	1.25	1.25



Saving Money and Space by Sizing Your Valves Properly

This catalog gives you a flow rating (Cv) for each valve in the Parker Hannifin line. You can “plug” your requirements into the following simple formula, and determine the Cv needed to do the job. By not oversizing, you’ll save space and money, and you’ll ensure the valve you select will do the job.

Converting the Job Requirements Into Cv

(Capacity Co-efficient).

$$Cv = \frac{\text{Cylinder Area (Sq. In.)} \times \text{Cylinder Stroke (In.)} \times \text{Compression Factor (Table 2)} \times \text{“A” Constant (Table 2)}}{\text{Stroke Time (sec.)} \times 28.8}$$

Let’s work through an example:

We want to extend a 3-1/4" bore cylinder which has a 12" stroke in one second, and we have a supply pressure of 80 PSI to do the work. Here’s what we know:

- Cylinder Area for a 3-1/4" Bore, from Table 18.30 sq. in.
- Cylinder Stroke 12 in.
- Stroke Time Required in Seconds..... 1 sec.
- Compression Factor at 80 PSI, from Table 2..... 6.4
- “A” Constant for 80 PSI, from Table 2..... .048

Substituting in the formula, we have:

$$Cv = \frac{8.30 \times 12 \times 6.4 \times .048}{1 \times 28.8} = 1.06$$

Any valve, therefore, which has a Cv of at least 1.06, will extend our cylinder the specified distance in the required time.

Choosing the Valve “Series”

Your next step is to choose a basic valve design to do the job. For a quick guide to valve designs, see Table 3.

Having selected the basic valve design, consult the Capacity Co-efficient (Cv) tables which describe the individual valve capacities.

Selecting the Valve Model, Options and Accessories

Having determined Cv, series, port size, flow-path configuration (pre-determined by circuit design), and actuation method, you’re ready to choose the exact valve model number.

Read the pertinent catalog pages; note the exact model numbers, options and accessories you want. Then phone or write your Parker Hannifin air valve distributor. They will give you prompt, accurate service.

Note: Need circuit design help? Contact your local Parker Hannifin distributor. They are backed up by our regional Sales Engineers and offices. Between them, you’ll find answers to all of your questions.

Table 1

Effective Square-Inch Areas for Standard-Bore-Size Cylinders

Bore Size	Cylinder Area (Sq. In.)	Bore Size	Cylinder Area (Sq. In.)
3/4"	.44	4"	12.57
1"	.79	4-1/2"	15.90
1-1/8"	.99	5"	19.64
1-1/4"	1.23	6"	28.27
1-1/2"	1.77	7"	38.48
1-3/4"	2.41	8"	50.27
2"	3.14	10"	78.54
2-1/2"	4.91	12"	113.10
3-1/4"	8.30	14"	153.94
3-5/8"	10.32		

Table 2

Compression Factors and “A” Constants

Inlet Pressure (PSIG)	Compression Factor	“A” Constants for Various Pressure Drop*		
		2 PSI ΔP	5 PSI ΔP	10 PSI ΔP
10	1.6	.152	.103	
20	2.3	.126	.084	.065
30	3.0	.111	.073	.055
40	3.7	.100	.065	.048
50	4.4	.091	.059	.044
60	5.1	.085	.055	.040
70	5.7	.079	.051	.037
80	6.4	.075	.048	.035
90	7.1	.071	.046	.033
100	7.8	.068	.044	.032
110	8.5	.065	.042	.030
120	9.2	.063	.040	.029
130	9.9	.061	.039	.028
140	10.6	.058	.037	.027
150	11.2	.057	.036	.026
160	11.9	.055	.035	.025
170	12.6	.053	.034	.024
180	13.3	.052	.033	.024
190	14.0	.051	.032	.023
200	14.7	.050	.032	.023

Note: Use “A” constant at 5 PSI rP for most applications. On very critical applications, use “A” at 2 PSI rP. You will find in many cases, a 10 PSI rP is not detrimental, and can save money and mounting space.

* Tabulated values are the solution of $\frac{1}{22.48} \sqrt{\frac{GT}{(P_1 - P_2) P_2}}$ where T is for 68°F and G = 1 for Air.

Table 3

Characteristics of the Major Valve Designs

<p>A. Poppet 3-Way and 4-Way</p>	<ol style="list-style-type: none"> High flow capacities Minimum lubrication requirements Fast response Self-cleaning poppet seats Pressures of 15 to 150 PSIG (modifications for vacuum to 250 PSIG)
<p>B. Spool Valves (WCS) 3-Way and 4-Way</p>	<ol style="list-style-type: none"> Low friction Lower operating pressures Fast response Less wear Long Cycle Life - Under pressure, radial expansion of the seal occurs to maintain sealing contact with the valve bore Non-Lube Service - No lubrication required for continuous valve shifting Bi-Directional Spool Seals - Common spool used for any pressure, including vacuum
<p>C. Packed Bore 4-Way</p>	<ol style="list-style-type: none"> Wide range of flow capacities Wide range of flow-path configurations Pilot-operated models available Pressures of vacuum to 150 PSIG
<p>D. Rotary Or Reciprocating Disc 4-Way, manually operated</p>	<ol style="list-style-type: none"> Inexpensive Versatility in manual actuation

Cv – Capacity Co-efficients (sometimes called Flow Factors). Each flow path through the valve has its own Cv value. All Cv ratings for each valve cataloged on this page are listed on the front side of this sheet.

$$Cv = \frac{Q}{22.48} \sqrt{\frac{GT}{(P_1 - P_2) P_2}}$$

Q = Flow in Standard Cubic Feet per minute (14.7 PSIA at 60°F)
 P₁ = Inlet Absolute Pressure (gauge pressure + 14.7)
 P₂ = Outlet Absolute Pressure (gauge pressure + 14.7)
 Note: P₂ must be greater than .53 x P₁
 G = Specific Gravity of flowing medium (Air, G = 1)
 T = Absolute Temperature of Air (460 + °F)

Cv = Q x “A” (Table 2)



Air Preparation Units

Symbol Description

	Filter / Separator with manual drain
	Filter / Separator with automatic drain
	Oil Removal Filter
	Automatic Drain
	Lubricator less drain
	Lubricator with manual drain
	Lubricator with automatic filling
	Air Line Pressure Regulator adjustable, relieving
	Air Line Pressure Regulator pilot controlled, relieving
	Filter / Regulator (piggyback) manual drain relieving (with gauge)
	Filter / Regulator (piggyback) auto drain relieving
	Air Line Combo F-R-L simplified

Pneumatic Valves

Symbol Description

	3-Position, 4-Way, APB ports closed, center pos.
	3-Position, 4-Way, CE 5-Ported cylinder ports open to exhaust in center position
	3-Position, 4-Way, PC 5-Ported pressure ports open to exhaust in center position
	Quick Exhaust
	Shuttle

Cylinders

Symbol Description

	Standard double acting
	Single Acting
	Double Rod
	Spring Return
	Ram Type
	Telescope
	Tandum
	Duplex

Valve Actuators

Symbol Description

	Manual general symbol
	Push Button
	Lever
	Pedal or Treadle
	Mechanical cam, toggle, etc.
	Spring
	Detent line indicates which detent is in use
	Piezo
	Solenoid
	Internal Pilot Supply
	Remote Pilot Supply complete
	Remote Pilot Supply simplified
	And / Or Composite solenoid and pilot or manual override
	And / Or Composite solenoid and pilot or manual override and pilot

Lines and Functions

Symbol Description

	Solid Line - Main Line
	Dashed Line - Pilot Line
	Dotted Line - Exhaust or Drain Line
	Center Line - Enclosure Outline
	Lines Crossing (90° intersection not necessary)
	Lines Joining (90° intersection not necessary)
	Lines Joining
	Flow Direction hydraulic medium
	Flow Direction gaseous medium
	Energy Source
	Line with Fixed Restriction
	Line with Adjustable Restriction
	Flexible Line
	Plugged Port, Test Station, Power Take-off
	Quick Disconnect Without Checks connected
	Quick Disconnect Without Checks disconnected
	Quick Disconnect With Checks connected
	Quick Disconnect With Checks disconnected
	Quick Disconnect With One Check connected
	Quick Disconnect With One Check disconnected

Pneumatic Valves

Symbol Description

	Check
	Flow Control
	Relief Valve
	2-Position, 2-Way
	2-Position, 3-Way
	2-Position, 4-Way
	2-Position, 4-Way 5-Ported



Safety Guide For Selecting And Using Pneumatic Division Products And Related Accessories

WARNING:

FAILURE OR IMPROPER SELECTION OR IMPROPER USE OF PNEUMATIC DIVISION PRODUCTS, ASSEMBLIES OR RELATED ITEMS (“PRODUCTS”) CAN CAUSE DEATH, PERSONAL INJURY, AND PROPERTY DAMAGE. POSSIBLE CONSEQUENCES OF FAILURE OR IMPROPER SELECTION OR IMPROPER USE OF THESE PRODUCTS INCLUDE BUT ARE NOT LIMITED TO:

- Unintended or mistimed cycling or motion of machine members or failure to cycle
- Work pieces or component parts being thrown off at high speeds.
- Failure of a device to function properly for example, failure to clamp or unclamp an associated item or device.
- Explosion
- Suddenly moving or falling objects.
- Release of toxic or otherwise injurious liquids or gasses.

Before selecting or using any of these Products, it is important that you read and follow the instructions below.

1. GENERAL INSTRUCTIONS

- 1.1. Scope:** This safety guide is designed to cover general guidelines on the installation, use, and maintenance of Pneumatic Division Valves, FRLs (Filters, Pressure Regulators, and Lubricators), Vacuum products and related accessory components.
- 1.2. Fail-Safe:** Valves, FRLs, Vacuum products and their related components can and do fail without warning for many reasons. Design all systems and equipment in a fail-safe mode, so that failure of associated valves, FRLs or Vacuum products will not endanger persons or property.
- 1.3. Relevant International Standards:** For a good guide to the application of a broad spectrum of pneumatic fluid power devices see: ISO 4414:1998, Pneumatic Fluid Power – General Rules Relating to Systems. See www.iso.org for ordering information.
- 1.4. Distribution:** Provide a copy of this safety guide to each person that is responsible for selection, installation, or use of Valves, FRLs or Vacuum products. Do not select, or use Parker valves, FRLs or vacuum products without thoroughly reading and understanding this safety guide as well as the specific Parker publications for the products considered or selected.
- 1.5. User Responsibility:** Due to the wide variety of operating conditions and applications for valves, FRLs, and vacuum products Parker and its distributors do not represent or warrant that any particular valve, FRL or vacuum product is suitable for any specific end use system. This safety guide does not analyze all technical parameters that must be considered in selecting a product. The user, through its own analysis and testing, is solely responsible for:
 - Making the final selection of the appropriate valve, FRL, Vacuum component, or accessory.
 - Assuring that all user’s performance, endurance, maintenance, safety, and warning requirements are met and that the application presents no health or safety hazards.
 - Complying with all existing warning labels and / or providing all appropriate health and safety warnings on the equipment on which the valves, FRLs or Vacuum products are used; and,
 - Assuring compliance with all applicable government and industry standards.
- 1.6. Safety Devices:** Safety devices should not be removed, or defeated.
- 1.7. Warning Labels:** Warning labels should not be removed, painted over or otherwise obscured.
- 1.8. Additional Questions:** Call the appropriate Parker technical service department if you have any questions or require any additional information. See the Parker publication for the product being considered or used, or call 1-800-CPARKER, or go to www.parker.com, for telephone numbers of the appropriate technical service department.

2. PRODUCT SELECTION INSTRUCTIONS

- 2.1. Flow Rate:** The flow rate requirements of a system are frequently the primary consideration when designing any pneumatic system. System components need to be able to provide adequate flow and pressure for the desired application.
- 2.2. Pressure Rating:** Never exceed the rated pressure of a product. Consult product labeling, Pneumatic Division catalogs or the instruction sheets supplied for maximum pressure ratings.
- 2.3. Temperature Rating:** Never exceed the temperature rating of a product. Excessive heat can shorten the life expectancy of a product and result in complete product failure.
- 2.4. Environment:** Many environmental conditions can affect the integrity and suitability of a product for a given application. Pneumatic Division products are designed for use in general purpose industrial applications. If these products are to be used in unusual circumstances such as direct sunlight and/or corrosive or caustic environments, such use can shorten the useful life and lead to premature failure of a product.
- 2.5. Lubrication and Compressor Carryover:** Some modern synthetic oils can and will attack nitrile seals. If there is any possibility of synthetic oils or greases migrating into the pneumatic components check for compatibility with the seal materials used. Consult the factory or product literature for materials of construction.
- 2.6. Polycarbonate Bowls and Sight Glasses:** To avoid potential polycarbonate bowl failures:
 - Do not locate polycarbonate bowls or sight glasses in areas where they could be subject to direct sunlight, impact blow, or temperatures outside of the rated range.
 - Do not expose or clean polycarbonate bowls with detergents, chlorinated hydro-carbons, keytones, esters or certain alcohols.
 - Do not use polycarbonate bowls or sight glasses in air systems where compressors are lubricated with fire resistant fluids such as phosphate ester and di-ester lubricants.

2.7. Chemical Compatibility: For more information on plastic component chemical compatibility see Pneumatic Division technical bulletins Tec-3, Tec-4, and Tec-5

- 2.8. Product Rupture:** Product rupture can cause death, serious personal injury, and property damage.
- Do not connect pressure regulators or other Pneumatic Division products to bottled gas cylinders.
 - Do not exceed the maximum primary pressure rating of any pressure regulator or any system component.
 - Consult product labeling or product literature for pressure rating limitations.

3. PRODUCT ASSEMBLY AND INSTALLATION INSTRUCTIONS

- 3.1. Component Inspection:** Prior to assembly or installation a careful examination of the valves, FRLs or vacuum products must be performed. All components must be checked for correct style, size, and catalog number. DO NOT use any component that displays any signs of nonconformance.
- 3.2. Installation Instructions:** Parker published Installation Instructions must be followed for installation of Parker valves, FRLs and vacuum components. These instructions are provided with every Parker valve or FRL sold, or by calling 1-800-CPARKER, or at www.parker.com.
- 3.3. Air Supply:** The air supply or control medium supplied to Valves, FRLs and Vacuum components must be moisture-free if ambient temperature can drop below freezing

4. VALVE AND FRL MAINTENANCE AND REPLACEMENT INSTRUCTIONS

- 4.1. Maintenance:** Even with proper selection and installation, valve, FRL and vacuum products service life may be significantly reduced without a continuing maintenance program. The severity of the application, risk potential from a component failure, and experience with any known failures in the application or in similar applications should determine the frequency of inspections and the servicing or replacement of Pneumatic Division products so that products are replaced before any failure occurs. A maintenance program must be established and followed by the user and, at minimum, must include instructions 4.2 through 4.10.
- 4.2. Installation and Service Instructions:** Before attempting to service or replace any worn or damaged parts consult the appropriate Service Bulletin for the valve or FRL in question for the appropriate practices to service the unit in question. These Service and Installation Instructions are provided with every Parker valve and FRL sold, or are available by calling 1-800-CPARKER, or by accessing the Parker web site at www.parker.com.
- 4.3. Lockout / Tagout Procedures:** Be sure to follow all required lockout and tagout procedures when servicing equipment. For more information see: OSHA Standard – 29 CFR, Part 1910.147, Appendix A, The Control of Hazardous Energy – (Lockout / Tagout)
- 4.4. Visual Inspection:** Any of the following conditions requires immediate system shut down and replacement of worn or damaged components:
- Air leakage: Look and listen to see if there are any signs of visual damage to any of the components in the system. Leakage is an indication of worn or damaged components.
 - Damaged or degraded components: Look to see if there are any visible signs of wear or component degradation.
 - Kinked, crushed, or damaged hoses. Kinked hoses can result in restricted air flow and lead to unpredictable system behavior.
 - Any observed improper system or component function: Immediately shut down the system and correct malfunction.
 - Excessive dirt build-up: Dirt and clutter can mask potentially hazardous situations.
- Caution: Leak detection solutions should be rinsed off after use.

4.5. Routine Maintenance Issues:

- Remove excessive dirt, grime and clutter from work areas.
- Make sure all required guards and shields are in place.

4.6. Functional Test: Before initiating automatic operation, operate the system manually to make sure all required functions operate properly and safely.

4.7. Service or Replacement Intervals: It is the user's responsibility to establish appropriate service intervals. Valves, FRLs and vacuum products contain components that age, harden, wear, and otherwise deteriorate over time. Environmental conditions can significantly accelerate this process. Valves, FRLs and vacuum components need to be serviced or replaced on routine intervals. Service intervals need to be established based on:

- Previous performance experiences.
- Government and / or industrial standards.
- When failures could result in unacceptable down time, equipment damage or personal injury risk.

4.8. Servicing or Replacing of any Worn or Damaged Parts: To avoid unpredictable system behavior that can cause death, personal injury and property damage:

- Follow all government, state and local safety and servicing practices prior to service including but not limited to all OSHA Lockout Tagout procedures (OSHA Standard – 29 CFR, Part 1910.147, Appendix A, The Control of Hazardous Energy – Lockout / Tagout).
- Disconnect electrical supply (when necessary) before installation, servicing, or conversion.
- Disconnect air supply and depressurize all air lines connected to system and Pneumatic Division products before installation, service, or conversion.
- Installation, servicing, and / or conversion of these products must be performed by knowledgeable personnel who understand how pneumatic products are to be applied.
- After installation, servicing, or conversions air and electrical supplies (when necessary) should be connected and the product tested for proper function and leakage. If audible leakage is present, or if the product does not operate properly, do not put product or system into use.
- Warnings and specifications on the product should not be covered or painted over. If masking is not possible, contact your local representative for replacement labels.

4.9. Putting Serviced System Back into Operation: Follow the guidelines above and all relevant Installation and Maintenance Instructions supplied with the valve FRL or vacuum component to insure proper function of the system.



The goods, services or work (referred to as the "Products") offered by **Parker-Hannifin Corporation**, its subsidiaries, groups, divisions, and authorized distributors ("Seller") are offered for sale at prices indicated in the offer, or as may be established by Seller. The offer to sell the Products and acceptance of Seller's offer by any customer ("Buyer") is contingent upon, and will be governed by all of the terms and conditions contained in this Offer of Sale. Buyer's order for any Products specified in Buyer's purchase document or Seller's offer, proposal or quote ("Quote") attached to the purchase order, when communicated to Seller verbally, or in writing, shall constitute acceptance of this offer.

1. Terms and Conditions. Seller's willingness to offer Products for sale or accept an order for Products is subject to the terms and conditions contained in this Offer of Sale or any newer version of the same, published by Seller electronically at www.parker.com/saleterms/. Seller objects to any contrary or additional terms or conditions of Buyer's order or any other document or other communication issued by Buyer.

2. Price; Payment. Prices stated on Seller's Quote are valid for thirty (30) days, except as explicitly otherwise stated therein, and do not include any sales, use, or other taxes or duties unless specifically stated. Seller reserves the right to modify prices to adjust for any raw material price fluctuations. Unless otherwise specified by Seller, all prices are F.C.A. Seller's facility (INCOTERMS 2010). Payment is subject to credit approval and payment for all purchases is due thirty (30) days from the date of invoice (or such date as may be specified by Seller's Credit Department). Unpaid invoices beyond the specified payment date incur interest at the rate of 1.5% per month or the maximum allowable rate under applicable law.

3. Shipment; Delivery; Title and Risk of Loss. All delivery dates are approximate. Seller is not responsible for damages resulting from any delay. Regardless of the manner of shipment, delivery occurs and title and risk of loss or damage pass to Buyer, upon placement of the Products with the shipment carrier at Seller's facility. Unless otherwise stated, Seller may exercise its judgment in choosing the carrier and means of delivery. No deferral of shipment at Buyers' request beyond the respective dates indicated will be made except on terms that will indemnify, defend and hold Seller harmless against all loss and additional expense. Buyer shall be responsible for any additional shipping charges incurred by Seller due to Buyer's acts or omissions.

4. Warranty. Seller warrants that the Products sold hereunder shall be free from defects in material or workmanship for a period of twelve (12) months from the date of delivery or 2,000 hours of normal use, whichever occurs first. All prices are based upon the exclusive limited warranty stated above, and upon the following disclaimer: **DISCLAIMER OF WARRANTY: THIS WARRANTY IS THE SOLE AND ENTIRE WARRANTY PERTAINING TO PRODUCTS PROVIDED. SELLER DISCLAIMS ALL OTHER WARRANTIES, EXPRESS AND IMPLIED, INCLUDING DESIGN, MERCHANTABILITY AND FITNESS FOR A PARTICULAR PURPOSE.**

5. Claims; Commencement of Actions. Buyer shall promptly inspect all Products upon receipt. No claims for shortages will be allowed unless reported to the Seller within ten (10) days of delivery. No other claims against Seller will be allowed unless asserted in writing within thirty (30) days after delivery. Buyer shall notify Seller of any alleged breach of warranty within thirty (30) days after the date the defect is or should have been discovered by Buyer. Any claim or action against Seller based upon breach of contract or any other theory, including tort, negligence, or otherwise must be commenced within twelve (12) months from the date of the alleged breach or other alleged event, without regard to the date of discovery.

6. LIMITATION OF LIABILITY. IN THE EVENT OF A BREACH OF WARRANTY, SELLER WILL, AT ITS OPTION, REPAIR OR REPLACE A DEFECTIVE PRODUCT, OR REFUND THE PURCHASE PRICE WITHIN A REASONABLE PERIOD OF TIME. **IN NO EVENT IS SELLER LIABLE FOR ANY SPECIAL, INDIRECT, INCIDENTAL OR CONSEQUENTIAL DAMAGES ARISING OUT OF, OR AS THE RESULT OF, THE SALE, DELIVERY, NON-DELIVERY, SERVICING, USE OR LOSS OF USE OF THE PRODUCTS OR ANY PART THEREOF, OR FOR ANY CHARGES OR EXPENSES OF ANY NATURE INCURRED WITHOUT SELLER'S WRITTEN CONSENT, WHETHER BASED IN CONTRACT, TORT OR OTHER LEGAL THEORY. IN NO EVENT SHALL SELLER'S LIABILITY UNDER ANY CLAIM MADE BY BUYER EXCEED THE PURCHASE PRICE OF THE PRODUCTS.**

7. User Responsibility. The user, through its own analysis and testing, is solely responsible for making the final selection of the system and Product and assuring that all performance, endurance, maintenance, safety and warning requirements of the application are met. The user must analyze all aspects of the application and follow applicable industry standards and Product information. If Seller provides Product or system options based upon data or specifications provided by the user, the user is responsible for determining that such data and specifications are suitable and sufficient for all applications and reasonably foreseeable uses of the Products or systems.

8. Loss to Buyer's Property. Any designs, tools, patterns, materials, drawings, confidential information or equipment furnished by Buyer or any other items which become Buyer's property, will be considered obsolete and may be destroyed by Seller after two (2) consecutive years have elapsed without Buyer ordering the items manufactured using such property. Seller shall not be responsible for any loss or damage to such property while it is in Seller's possession or control.

9. Special Tooling. A tooling charge may be imposed for any special tooling, including without limitation, dies, fixtures, molds and patterns, acquired to manufacture Products. Such special tooling shall be and remain Seller's property notwithstanding payment of any charges by Buyer. In no event will Buyer acquire any interest in apparatus belonging to Seller which is utilized in the manufacture of the Products, even if such apparatus has been specially converted or adapted for such manufacture and notwithstanding any charges paid by Buyer. Unless otherwise agreed, Seller has the right to alter, discard or otherwise dispose of any special tooling or other property in its sole discretion at any time.

10. Buyer's Obligation; Rights of Seller. To secure payment of all sums due or otherwise, Seller retains a security interest in all Products delivered to Buyer and this agreement is deemed to be a Security Agreement under the Uniform Commercial Code. Buyer authorizes Seller as its attorney to execute and file on Buyer's behalf all documents Seller deems necessary to perfect its security interest.

11. Improper Use and Indemnity. Buyer shall indemnify, defend, and hold Seller harmless from any losses, claims, liabilities, damages, lawsuits, judgments and costs

(including attorney fees and defense costs), whether for personal injury, property damage, patent, trademark or copyright infringement or any other claim, brought by or incurred by Buyer, Buyer's employees, or any other person, arising out of: (a) improper selection, application, design, specification or other misuse of Products purchased by Buyer from Seller; (b) any act or omission, negligent or otherwise, of Buyer; (c) Seller's use of patterns, plans, drawings, or specifications furnished by Buyer to manufacture Products; or (d) Buyer's failure to comply with these terms and conditions. Seller shall not indemnify Buyer under any circumstance except as otherwise provided.

12. Cancellations and Changes. Buyer may not cancel or modify or cancel any order for any reason, except with Seller's written consent and upon terms that will indemnify, defend and hold Seller harmless against all direct, incidental and consequential loss or damage. Seller may change Product features, specifications, designs and availability.

13. Limitation on Assignment. Buyer may not assign its rights or obligations under this agreement without the prior written consent of Seller.

14. Force Majeure. Seller does not assume the risk and is not liable for delay or failure to perform any of Seller's obligations by reason of events or circumstances beyond its reasonable control (hereinafter "Events of Force Majeure"). Events of Force Majeure shall include without limitation: accidents, strikes or labor disputes, acts of any government or government agency, acts of nature, delays or failures in delivery from carriers or suppliers, shortages of materials, or any other cause beyond Seller's reasonable control.

15. Waiver and Severability. Failure to enforce any provision of this agreement will not invalidate that provision; nor will any such failure prejudice Seller's right to enforce that provision in the future. Invalidation of any provision of this agreement by legislation or other rule of law shall not invalidate any other provision herein. The remaining provisions of this agreement will remain in full force and effect.

16. Termination. Seller may terminate this agreement for any reason and at any time by giving Buyer thirty (30) days prior written notice. Seller may immediately terminate this agreement, in writing, if Buyer: (a) breaches any provision of this agreement (b) appoints a trustee, receiver or custodian for all or any part of Buyer's property (c) files a petition for relief in bankruptcy on its own behalf, or one if filed by a third party (d) makes an assignment for the benefit of creditors; or (e) dissolves its business or liquidates all or a majority of its assets.

17. Governing Law. This agreement and the sale and delivery of all Products are deemed to have taken place in, and shall be governed and construed in accordance with, the laws of the State of Ohio, as applicable to contracts executed and wholly performed therein and without regard to conflicts of laws principles. Buyer irrevocably agrees and consents to the exclusive jurisdiction and venue of the courts of Cuyahoga County, Ohio with respect to any dispute, controversy or claim arising out of or relating to this agreement.

18. Indemnity for Infringement of Intellectual Property Rights. Seller is not liable for infringement of any patents, trademarks, copyrights, trade dress, trade secrets or similar rights except as provided in this Section. Seller will defend and indemnify Buyer against allegations of infringement of U.S. patents, U.S. trademarks, copyrights, trade dress and trade secrets ("Intellectual Property Rights"). Seller will defend at its expense and will pay the cost of any settlement or damages awarded in an action brought against Buyer based on an allegation that a Product sold pursuant to this agreement infringes the Intellectual Property Rights of a third party. Seller's obligation to defend and indemnify Buyer is contingent on Buyer notifying Seller within ten (10) days after Buyer becomes aware of such allegations of infringement, and Seller having sole control over the defense of any allegations or actions including all negotiations for settlement or compromise. If a Product is subject to a claim that it infringes the Intellectual Property Rights of a third party, Seller may, at its sole expense and option, procure for Buyer the right to continue using the Product, replace or modify the Product so as to make it noninfringing, or offer to accept return of the Product and refund the purchase price less a reasonable allowance for depreciation. Notwithstanding the foregoing, Seller is not liable for claims of infringement based on information provided by Buyer, or directed to Products delivered hereunder for which the designs are specified in whole or part by Buyer, or infringements resulting from the modification, combination or use in a system of any Product sold hereunder. The foregoing provisions of this Section constitute Seller's sole and exclusive liability and Buyer's sole and exclusive remedy for infringement of Intellectual Property Rights.

19. Entire Agreement. This agreement contains the entire agreement between the Buyer and Seller and constitutes the final, complete and exclusive expression of the terms of sale. All prior or contemporaneous written or oral agreements or negotiations with respect to the subject matter are herein merged. The terms contained herein may not be modified unless in writing and signed by an authorized representative of Seller.

20. Compliance with Laws. Buyer agrees to comply with all applicable laws, regulations, and industry and professional standards of care, including those of the United Kingdom, the United States of America, and the country or countries in which Buyer may operate, including without limitation the U. K. Bribery Act, the U.S. Foreign Corrupt Practices Act ("FCPA"), the U.S. Anti-Kickback Act ("Anti-Kickback Act") and the U.S. Food Drug and Cosmetic Act ("FDCA"), each as currently amended, and the rules and regulations promulgated by the U.S. Food and Drug Administration ("FDA"), and agrees to indemnify and hold harmless Seller from the consequences of any violation of such provisions by Buyer, its employees or agents. Buyer acknowledges that it is familiar with the provisions of the U. K. Bribery Act, the FCPA, the FDA, and the Anti-Kickback Act, and certifies that Buyer will adhere to the requirements thereof. In particular, Buyer represents and agrees that Buyer will not make any payment or give anything of value, directly or indirectly to any governmental official, any foreign political party or official thereof, any candidate for foreign political office, or any commercial entity or person, for the purpose of influencing such person to purchase Products or otherwise benefit the business of Seller.

05/14





Catalog 0697P 04/2013



Parker Hannifin Corporation
Pneumatic Division
8676 E. M89
P.O. Box 901
Richland, MI 49083 USA
Tel: 269 629 5000
Fax: 269 629 5385

Applications Engineering
Phone: 877 321 4PDN Option #2
E-mail: pdnapps@parker.com
Customer Support
Phone: 877 321 4PDN Option #1
E-mail: pdncustsvc@parker.com
Web site: www.parker.com/pneumatics